

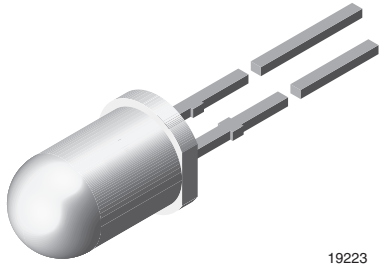

High Efficiency Blue LED, Ø 5 mm Untinted Non-Diffused Package



19223

DESCRIPTION

This device has been designed in GaN on SiC technology to meet the increasing demand for high efficiency blue LEDs.

It is housed in a 5 mm waterclear plastic package.

All packing units are categorized in luminous intensity groups. That allows users to assemble LEDs with uniform appearance.

PRODUCT GROUP AND PACKAGE DATA

- Product group: LED
- Package: 5 mm
- Product series: standard
- Angle of half intensity: $\pm 9^\circ$

FEATURES

- GaN on SiC technology
- Standard Ø 5 mm T-1 $\frac{3}{4}$ package
- Small mechanical tolerances
- Small viewing angle
- Very high intensity
- Luminous intensity categorized
- ESD class 1
- Material categorization:
For definitions of compliance please see www.vishay.com/doc?99912



APPLICATIONS

- Status lights
- Off/on indicator
- Background illumination
- Readout lights
- Maintenance lights
- Legend light

PARTS TABLE														
PART	COLOR	LUMINOUS INTENSITY (mcd)			at I _F (mA)	WAVELENGTH (nm)			at I _F (mA)	FORWARD VOLTAGE (V)			at I _F (mA)	TECHNOLOGY
		MIN.	TYP.	MAX.		MIN.	TYP.	MAX.		MIN.	TYP.	MAX.		
TLHB5100	Blue	63	250	-	20	-	466	-	10	-	3.9	4.5	20	GaN on SiC
TLHB5102	Blue	130	-	360	20	-	466	-	10	-	3.9	4.5	20	GaN on SiC

ABSOLUTE MAXIMUM RATINGS (T _{amb} = 25 °C, unless otherwise specified) TLHB510.				
PARAMETER	TEST CONDITION	SYMBOL	VALUE	UNIT
Reverse voltage		V _R	5	V
DC forward current	T _{amb} ≤ 65 °C	I _F	20	mA
Surge forward current	t _p ≤ 10 μs	I _{FSM}	0.1	A
Power dissipation	T _{amb} ≤ 65 °C	P _V	100	mW
Junction temperature		T _j	100	°C
Operating temperature range		T _{amb}	- 40 to + 100	°C
Storage temperature range		T _{stg}	- 40 to + 100	°C
Soldering temperature	t ≤ 5 s, 2 mm from body	T _{sd}	260	°C
Thermal resistance junction/ambient		R _{thJA}	350	K/W



OPTICAL AND ELECTRICAL CHARACTERISTICS ($T_{amb} = 25\text{ }^{\circ}\text{C}$, unless otherwise specified)							
TLHB5100, TLHB5102, BLUE							
PARAMETER	TEST CONDITION	PART	SYMBOL	MIN.	TYP.	MAX.	UNIT
Luminous intensity ⁽¹⁾	$I_F = 20\text{ mA}$	TLHB5100	I_V	63	250	-	mcd
		TLHB5102	I_V	130	-	360	mcd
Dominant wavelength	$I_F = 10\text{ mA}$		λ_d	-	466	-	nm
Peak wavelength	$I_F = 10\text{ mA}$		λ_p	-	428	-	nm
Angle of half intensity	$I_F = 10\text{ mA}$		φ	-	± 9	-	deg
Forward voltage	$I_F = 20\text{ mA}$		V_F	-	3.9	4.5	V
Reverse voltage	$I_R = 10\text{ }\mu\text{A}$		V_R	5	-	-	V

Note

(1) In one packing unit $I_{Vmin}/I_{Vmax} \leq 0.5$

LUMINOUS INTENSITY CLASSIFICATION		
GROUP	LUMINOUS INTENSITY (mcd)	
STANDARD	MIN.	MAX.
V	63	125
W	100	200
X	130	260
Y	180	360
Z	240	480
AA	320	640
BB	430	860

Note

- Luminous intensity is tested at a current pulse duration of 25 ms and an accuracy of $\pm 11\%$. The above type numbers represent the order groups which include only a few brightness groups. Only one group will be shipped on each bag (there will be no mixing of two groups on each bag). In order to ensure availability, single brightness groups will not be orderable. In a similar manner for colors where wavelength groups are measured and binned, single wavelength groups will be shipped in any one bag. In order to ensure availability, single wavelength groups will not be orderable.

TYPICAL CHARACTERISTICS ($T_{amb} = 25\text{ }^{\circ}\text{C}$, unless otherwise specified)

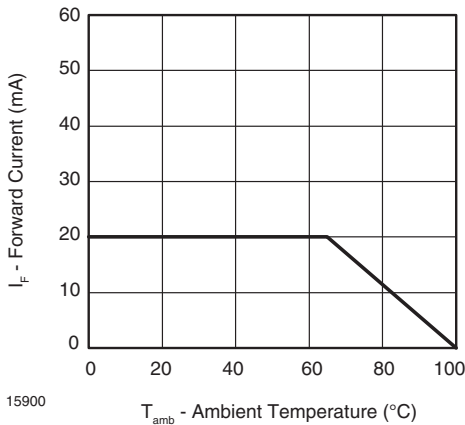

Fig. 1 - Forward Current vs. Ambient Temperature

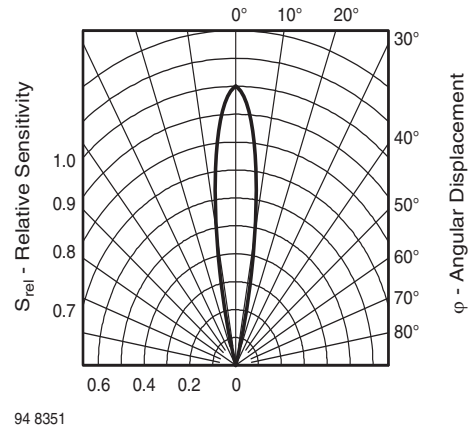

Fig. 2 - Relative Radiant Sensitivity vs. Angular Displacement

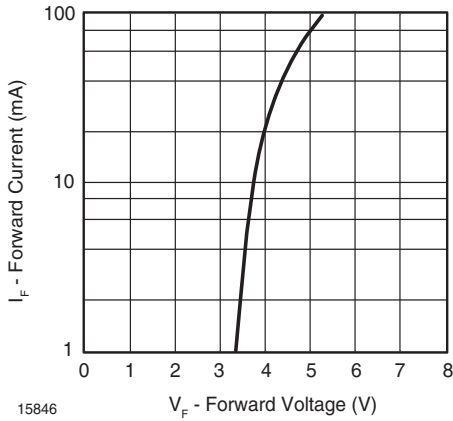

Fig. 3 - Forward Current vs. Forward Voltage

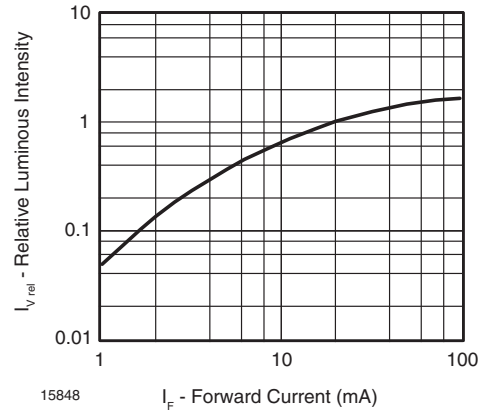

Fig. 5 - Relative Luminous Flux vs. Forward Current

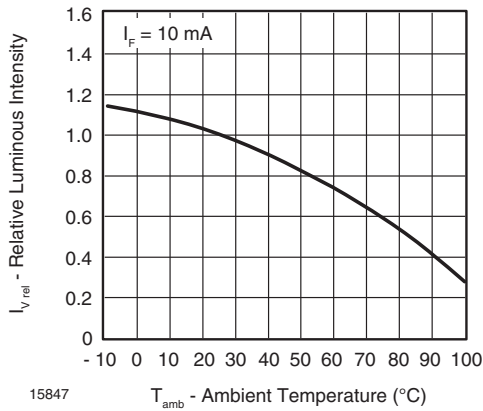

Fig. 4 - Rel. Luminous Flux vs. Ambient Temperature

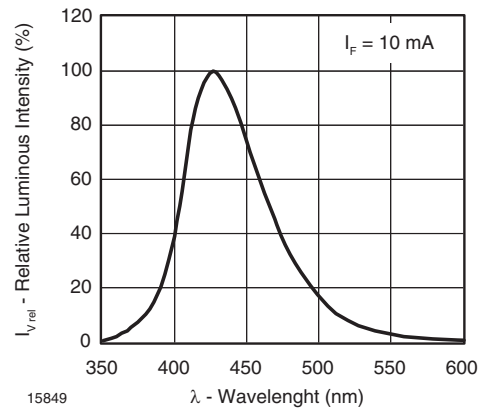
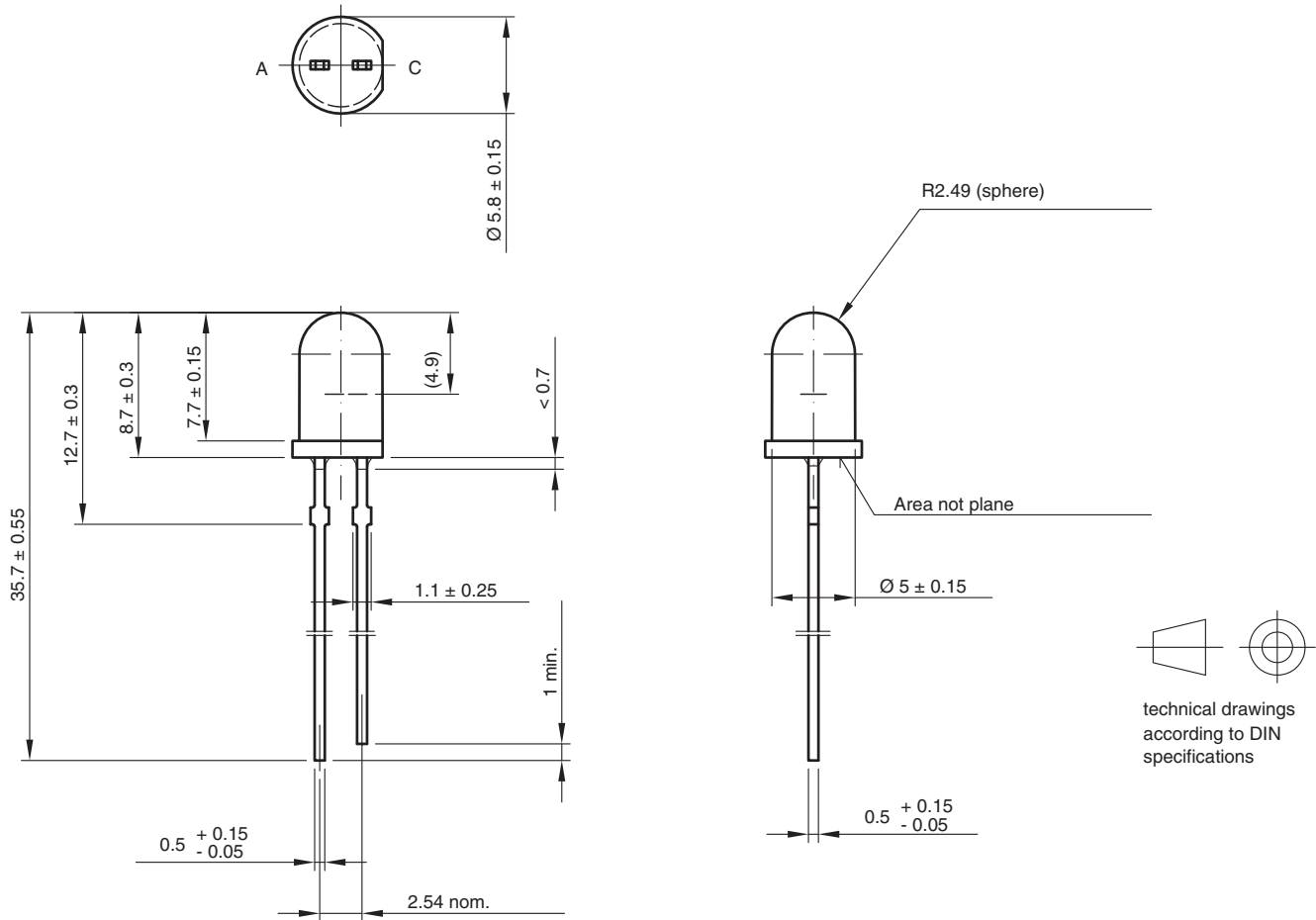

Fig. 6 - Relative Intensity vs. Wavelength



PACKAGE DIMENSIONS in millimeters



6.544-5258.09-4
Issue: 4; 19.05.09
15909



Disclaimer

ALL PRODUCT, PRODUCT SPECIFICATIONS AND DATA ARE SUBJECT TO CHANGE WITHOUT NOTICE TO IMPROVE RELIABILITY, FUNCTION OR DESIGN OR OTHERWISE.

Vishay Intertechnology, Inc., its affiliates, agents, and employees, and all persons acting on its or their behalf (collectively, "Vishay"), disclaim any and all liability for any errors, inaccuracies or incompleteness contained in any datasheet or in any other disclosure relating to any product.

Vishay makes no warranty, representation or guarantee regarding the suitability of the products for any particular purpose or the continuing production of any product. To the maximum extent permitted by applicable law, Vishay disclaims (i) any and all liability arising out of the application or use of any product, (ii) any and all liability, including without limitation special, consequential or incidental damages, and (iii) any and all implied warranties, including warranties of fitness for particular purpose, non-infringement and merchantability.

Statements regarding the suitability of products for certain types of applications are based on Vishay's knowledge of typical requirements that are often placed on Vishay products in generic applications. Such statements are not binding statements about the suitability of products for a particular application. It is the customer's responsibility to validate that a particular product with the properties described in the product specification is suitable for use in a particular application. Parameters provided in datasheets and / or specifications may vary in different applications and performance may vary over time. All operating parameters, including typical parameters, must be validated for each customer application by the customer's technical experts. Product specifications do not expand or otherwise modify Vishay's terms and conditions of purchase, including but not limited to the warranty expressed therein.

Except as expressly indicated in writing, Vishay products are not designed for use in medical, life-saving, or life-sustaining applications or for any other application in which the failure of the Vishay product could result in personal injury or death. Customers using or selling Vishay products not expressly indicated for use in such applications do so at their own risk. Please contact authorized Vishay personnel to obtain written terms and conditions regarding products designed for such applications.

No license, express or implied, by estoppel or otherwise, to any intellectual property rights is granted by this document or by any conduct of Vishay. Product names and markings noted herein may be trademarks of their respective owners.