

High Intensity LED, ø 5 mm Untinted Non-Diffused

Color	Type	Technology	Angle of Half Intensity $\pm\varphi$
Red	TLHK51..	AllnGaP on GaAs	9°
Yellow	TLHE51..	AllnGaP on GaAs	9°
Green	TLHG51..	GaP on GaP	9°
Pure green	TLHP51..	GaP on GaP	9°

Description

The TLH.51.. series is a clear, non diffused 5 mm LED for outdoor application.

These clear lamps utilize the highly developed technologies like AllnGaP and GaP.

The lens and the viewing angle is optimized to achieve best performance of light output and visibility.

The subtypes TLH.5101 and TLH.5102 with their very stable light output are especially recommended for applications where a homogeneous appearance is required.

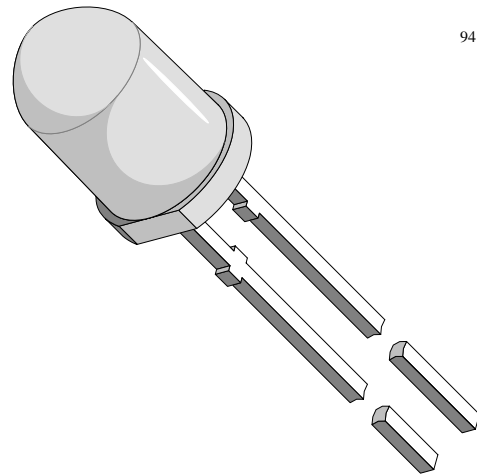

94 8631

Features

- Untinted non diffused lens
- Choice of four colors
- TLH.5101 and TLH.5102 with reduced light matching factor
- TLH.5100 for cost effective design
- Medium viewing angle

Applications

Outdoor LED panels
 Central high mounted stop lights (CHMSL) for motor vehicles
 Instrumentation and front panel indicators
 Light guide design
 Traffic signals

Absolute Maximum Ratings

$T_{amb} = 25^{\circ}\text{C}$, unless otherwise specified

TLHK51.., TLHE51.., TLHG51.., TLHP51..,

Parameter	Test Conditions	Symbol	Value	Unit
Reverse voltage		V_R	6	V
DC forward current	$T_{amb} \leq 65^{\circ}\text{C}$	I_F	30	mA
Surge forward current	$t_p \leq 10 \mu\text{s}$	I_{FSM}	1	A
Power dissipation	$T_{amb} \leq 65^{\circ}\text{C}$	P_V	100	mW
Junction temperature		T_j	100	$^{\circ}\text{C}$
Operating temperature range		T_{amb}	-20 to +100	$^{\circ}\text{C}$
Storage temperature range		T_{stg}	-55 to +100	$^{\circ}\text{C}$
Soldering temperature	$t \leq 5 \text{ s}$, 2 mm from body	T_{sd}	260	$^{\circ}\text{C}$
Thermal resistance junction/ambient		R_{thJA}	350	K/W

Optical and Electrical Characteristics

$T_{amb} = 25^{\circ}\text{C}$, unless otherwise specified

Red (TLHK51..)

Parameter	Test Conditions	Type	Symbol	Min	Typ	Max	Unit
Luminous intensity	$I_F = 20 \text{ mA}$, $I_{Vmin}/I_{Vmax} \geq 0.5$	TLHK5100	I_V	320			mcd
		TLHK5101	I_V	320		640	mcd
		TLHK5102	I_V	320		860	mcd
Dominant wavelength	$I_F = 10 \text{ mA}$		λ_d	626	630	639	nm
Peak wavelength	$I_F = 10 \text{ mA}$		λ_p		643		nm
Angle of half intensity	$I_F = 10 \text{ mA}$		φ		± 9		deg
Forward voltage	$I_F = 20 \text{ mA}$		V_F		1.9	2.6	V
Reverse voltage	$I_R = 10 \mu\text{A}$		V_R	5			V
Junction capacitance	$V_R = 0$, $f = 1 \text{ MHz}$		C_j		15		pF

Yellow (TLHE51..)

Parameter	Test Conditions	Type	Symbol	Min	Typ	Max	Unit
Luminous intensity	$I_F = 20 \text{ mA}$, $I_{Vmin}/I_{Vmax} \geq 0.5$	TLHE5100	I_V	750			mcd
		TLHE5101	I_V	750		1500	mcd
		TLHE5102	I_V	750		2000	mcd
Dominant wavelength	$I_F = 10 \text{ mA}$		λ_d	581	588	594	nm
Peak wavelength	$I_F = 10 \text{ mA}$		λ_p		590		nm
Angle of half intensity	$I_F = 10 \text{ mA}$		φ		± 9		deg
Forward voltage	$I_F = 20 \text{ mA}$		V_F		2	2.6	V
Reverse voltage	$I_R = 10 \mu\text{A}$		V_R	5			V
Junction capacitance	$V_R = 0$, $f = 1 \text{ MHz}$		C_j		15		pF



Green (TLHG51..)

Parameter	Test Conditions	Type	Symbol	Min	Typ	Max	Unit
Luminous intensity	$I_F = 20 \text{ mA}$, $I_{Vmin}/I_{Vmax} \geq 0.5$	TLHG5100	I_V	240			mcd
		TLHG5101	I_V	240		480	mcd
		TLHG5102	I_V	240		640	mcd
Dominant wavelength	$I_F = 10 \text{ mA}$		λ_d	562		575	nm
Peak wavelength	$I_F = 10 \text{ mA}$		λ_p		565		nm
Angle of half intensity	$I_F = 10 \text{ mA}$		ϕ		± 9		deg
Forward voltage	$I_F = 20 \text{ mA}$		V_F		2.4	3	V
Reverse voltage	$I_R = 10 \text{ }\mu\text{A}$		V_R	6	15		V
Junction capacitance	$V_R = 0$, $f = 1 \text{ MHz}$		C_j		50		pF

Pure green (TLHP51..)

Parameter	Test Conditions	Type	Symbol	Min	Typ	Max	Unit
Luminous intensity	$I_F = 20 \text{ mA}$, $I_{Vmin}/I_{Vmax} \geq 0.5$	TLHP5100	I_V	66			mcd
		TLHP5101	I_V	66		132	mcd
		TLHP5102	I_V	66		200	mcd
Dominant wavelength	$I_F = 10 \text{ mA}$		λ_d	555		565	nm
Peak wavelength	$I_F = 10 \text{ mA}$		λ_p		555		nm
Angle of half intensity	$I_F = 10 \text{ mA}$		ϕ		± 9		deg
Forward voltage	$I_F = 20 \text{ mA}$		V_F		2.4	3	V
Reverse voltage	$I_R = 10 \text{ }\mu\text{A}$		V_R	6	15		V
Junction capacitance	$V_R = 0$, $f = 1 \text{ MHz}$		C_j		50		pF

Typical Characteristics ($T_{amb} = 25^\circ\text{C}$, unless otherwise specified)

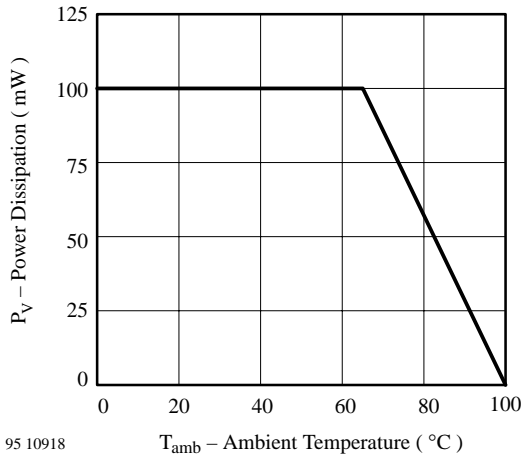

Figure 1 Power Dissipation vs. Ambient Temperature

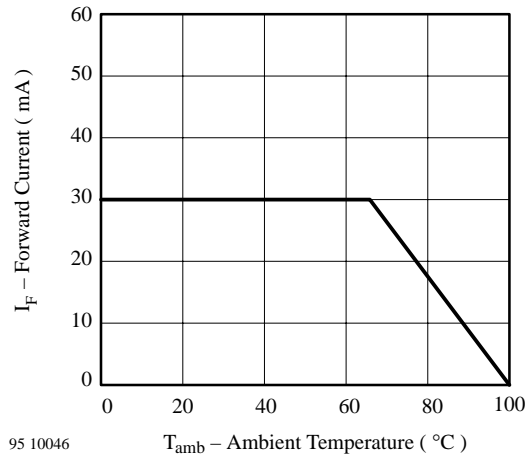
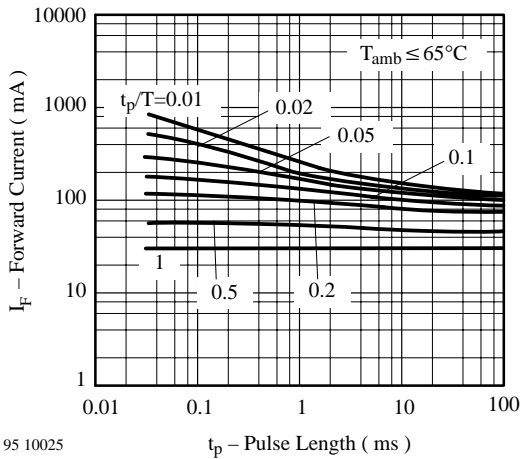
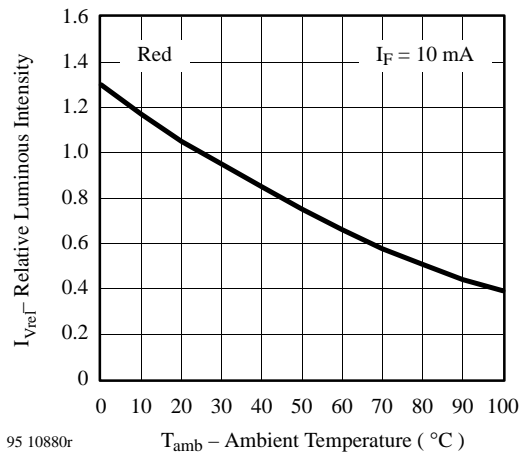

Figure 2 Forward Current vs. Ambient Temperature



95 10025

Figure 3 Forward Current vs. Pulse Length



95 10880r

Figure 6 Rel. Luminous Intensity vs. Ambient Temperature

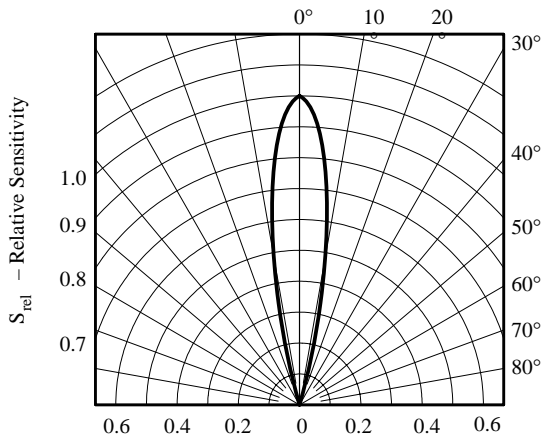

94 8351

Figure 4 Rel. Luminous Intensity vs. Angular Displacement

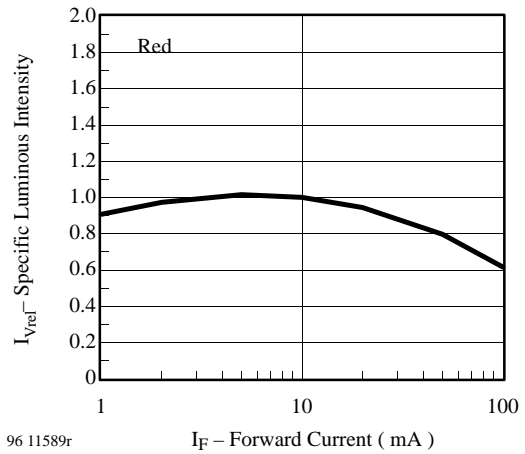

96 11589r

Figure 7 Specific Luminous Intensity vs. Forward Current

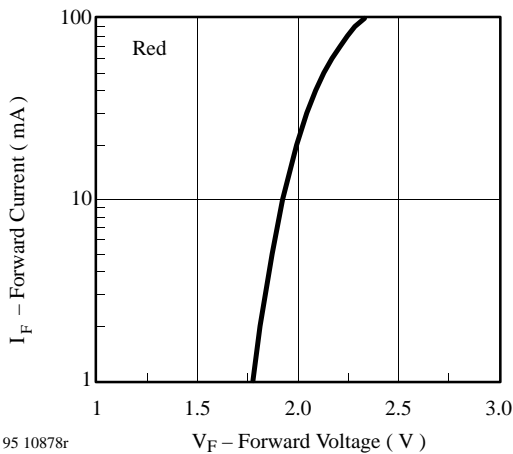

95 10878r

Figure 5 Forward Current vs. Forward Voltage

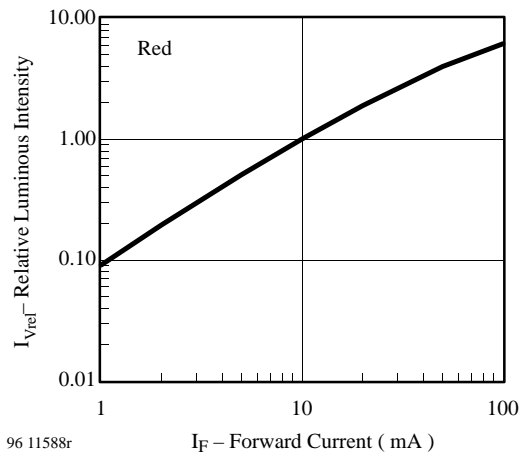

96 11588r

Figure 8 Relative Luminous Intensity vs. Forward Current

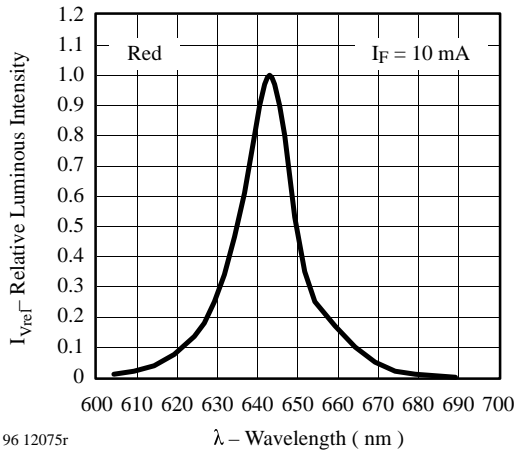

96 12075r

Figure 9 Relative Luminous Intensity vs. Wavelength

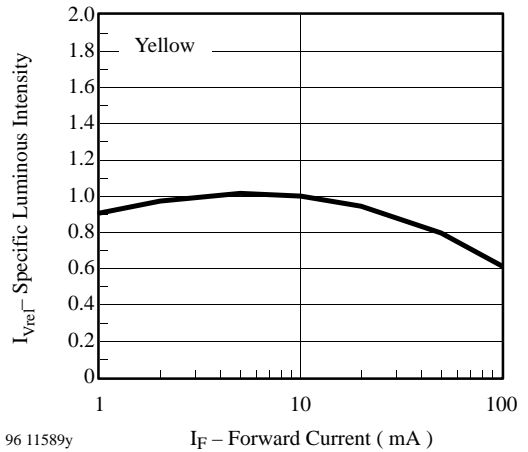

96 11589y

Figure 12 Specific Luminous Intensity vs. Forward Current

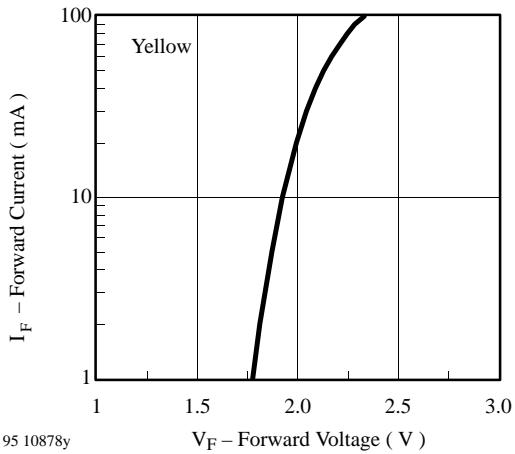

95 10878y

Figure 10 Forward Current vs. Forward Voltage

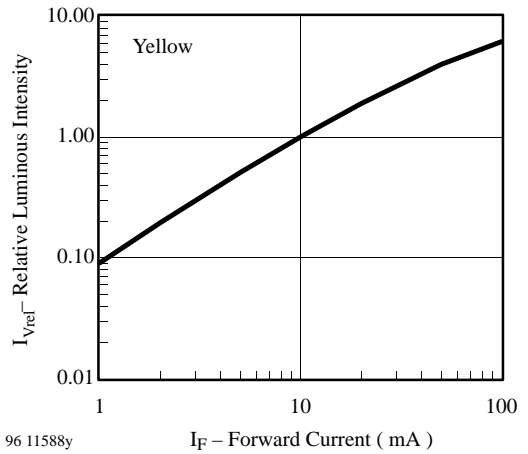

96 11588y

Figure 13 Relative Luminous Intensity vs. Forward Current

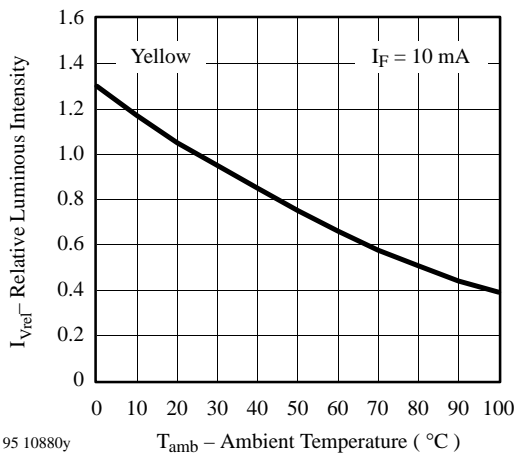

95 10880y

Figure 11 Rel. Luminous Intensity vs. Ambient Temperature

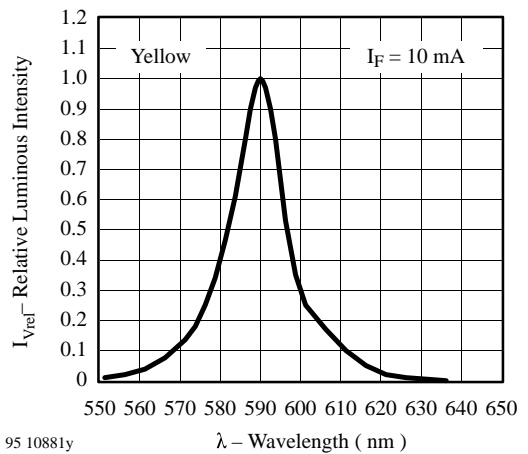

95 10881y

Figure 14 Relative Luminous Intensity vs. Wavelength

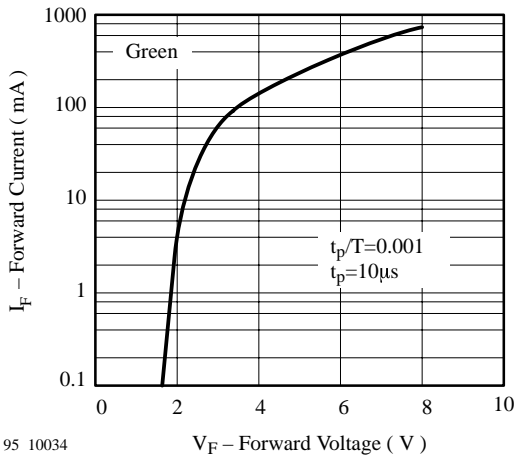

95 10034

Figure 15 Rel. Luminous Intensity vs. Ambient Temperature

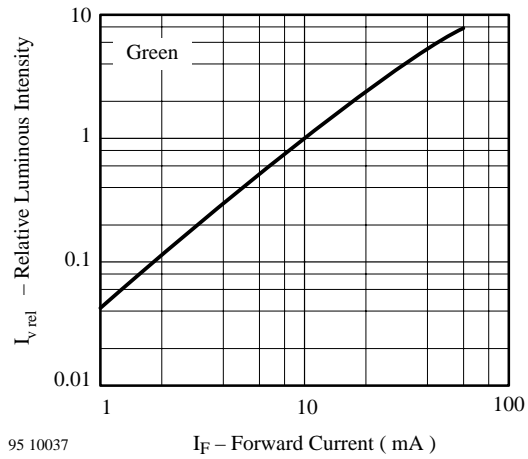

95 10037

Figure 18 Relative Luminous Intensity vs. Forward Current

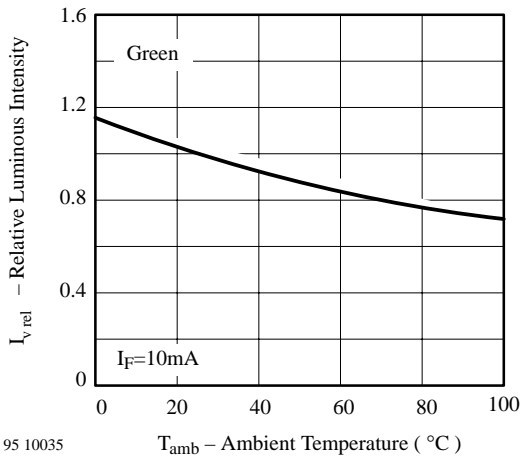

95 10035

Figure 16 Rel. Luminous Intensity vs. Ambient Temperature

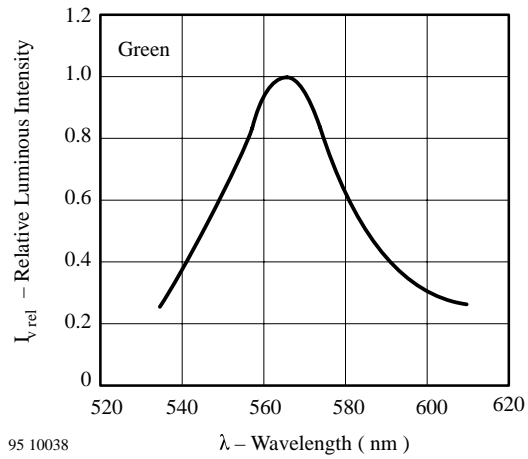

95 10038

Figure 19 Relative Luminous Intensity vs. Wavelength

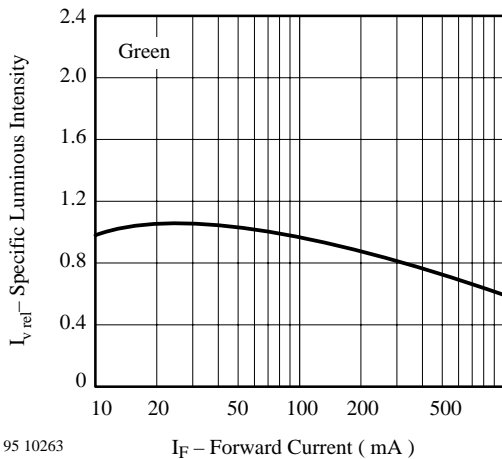

95 10263

Figure 17 Specific Luminous Intensity vs. Forward Current

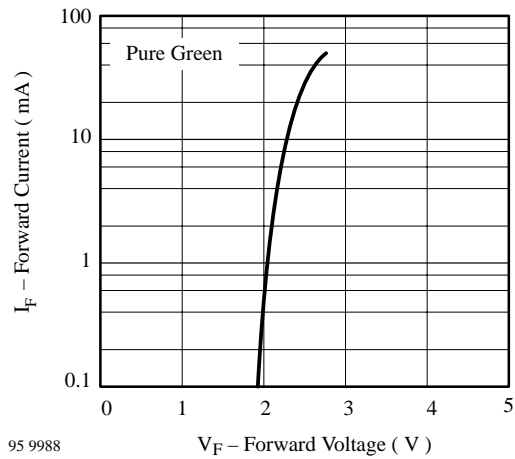

95 9988

Figure 20 Forward Current vs. Forward Voltage

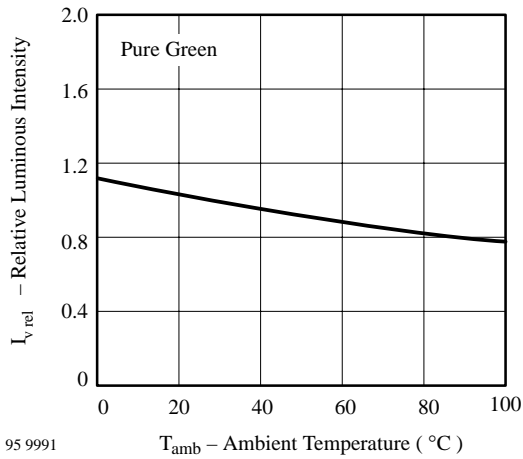

95 9991

Figure 21 Rel. Luminous Intensity vs. Ambient Temperature

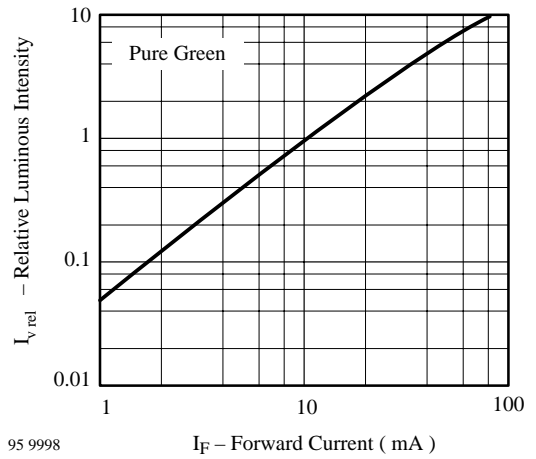

95 9998

Figure 23 Relative Luminous Intensity vs. Forward Current

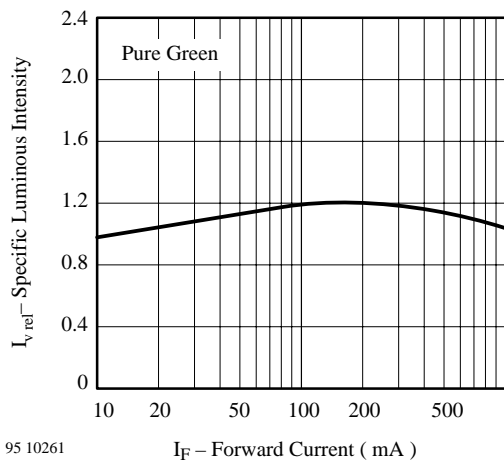

95 10261

Figure 22 Specific Luminous Intensity vs. Forward Current

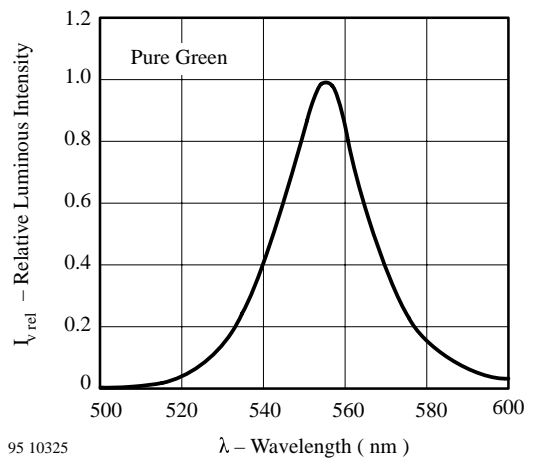

95 10325

Figure 24 Relative Luminous Intensity vs. Wavelength

Dimensions in mm

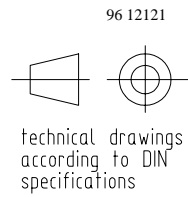
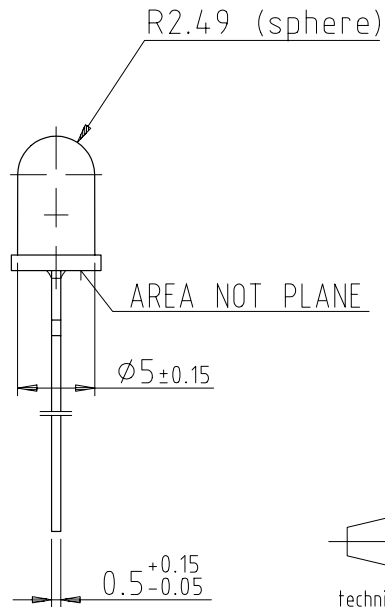
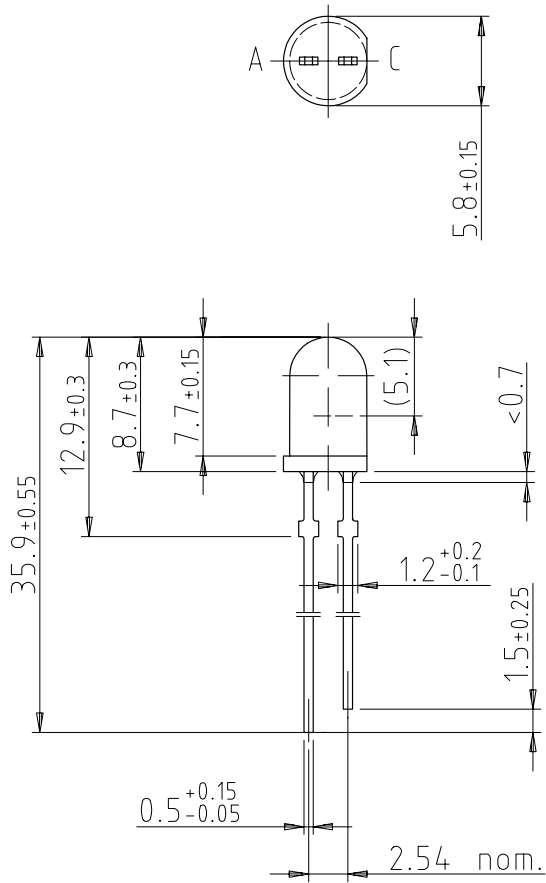



Ozone Depleting Substances Policy Statement

It is the policy of **Vishay Semiconductor GmbH** to

1. Meet all present and future national and international statutory requirements.
2. Regularly and continuously improve the performance of our products, processes, distribution and operating systems with respect to their impact on the health and safety of our employees and the public, as well as their impact on the environment.

It is particular concern to control or eliminate releases of those substances into the atmosphere which are known as ozone depleting substances (ODSs).

The Montreal Protocol (1987) and its London Amendments (1990) intend to severely restrict the use of ODSs and forbid their use within the next ten years. Various national and international initiatives are pressing for an earlier ban on these substances.

Vishay Semiconductor GmbH has been able to use its policy of continuous improvements to eliminate the use of ODSs listed in the following documents.

1. Annex A, B and list of transitional substances of the Montreal Protocol and the London Amendments respectively
2. Class I and II ozone depleting substances in the Clean Air Act Amendments of 1990 by the Environmental Protection Agency (EPA) in the USA
3. Council Decision 88/540/EEC and 91/690/EEC Annex A, B and C (transitional substances) respectively.

Vishay Semiconductor GmbH can certify that our semiconductors are not manufactured with ozone depleting substances and do not contain such substances.

We reserve the right to make changes to improve technical design and may do so without further notice.

Parameters can vary in different applications. All operating parameters must be validated for each customer application by the customer. Should the buyer use Vishay-Telefunken products for any unintended or unauthorized application, the buyer shall indemnify Vishay-Telefunken against all claims, costs, damages, and expenses, arising out of, directly or indirectly, any claim of personal damage, injury or death associated with such unintended or unauthorized use.

Vishay Semiconductor GmbH, P.O.B. 3535, D-74025 Heilbronn, Germany
Telephone: 49 (0)7131 67 2831, Fax number: 49 (0)7131 67 2423