

TOSHIBA PHOTO-INTERRUPTER INFRARED LED + PHOTO-IC

TLP1025

STILL CAMERAS

VIDEO CAMERAS

SMALL-SIZED COPIERS, PRINTERS AND FAX MACHINES
FOR PERSONAL USE

The TLP1025 digital-output photo-interrupter combines a GaAs infrared LED with a high-sensitivity, high-gain Si photo-IC on a single chip.

The device has a narrow slit width and offers high resolution.

Due to its built-in schmitt trigger circuit, the TLP1025 can be connected directly to a microcomputer or a logic IC. The device's output goes High when the light is shielded.

- Very small package
- Designed for direct mounting on printed circuit boards
- Gap : 1 mm
- High resolution
 - Slit width : 0.15 mm (infrared LED)
 - 0.1 mm (photo-IC)
- Digital output (open-collector)
- Built-in schmitt trigger circuit for direct connection to logic IC
- Low-voltage operation : $V_{CC} = 2.4\text{ V} \sim 7\text{ V}$
- High-speed response

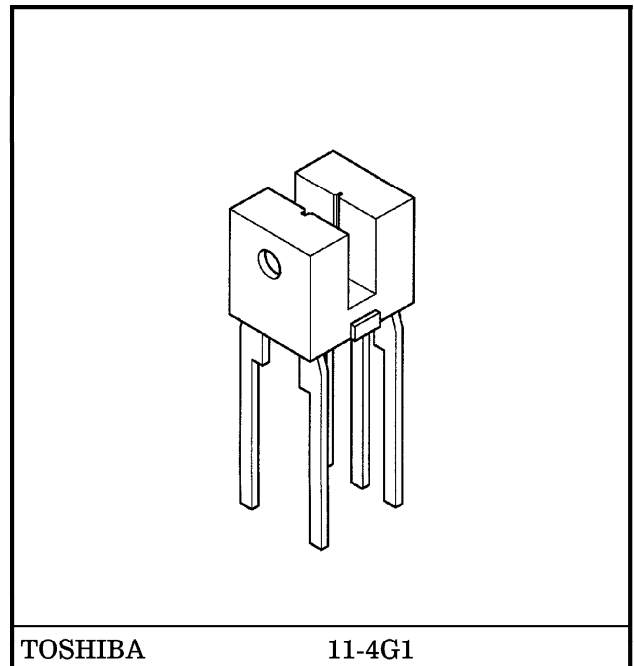

TOSHIBA

11-4G1

Weight : 0.09 g (typ.)

MAXIMUM RATINGS (Ta = 25°C)

CHARACTERISTIC		SYMBOL	RATING	UNIT
LED	Forward Current	I _F	50	mA
	Forward Current Derating (Ta ≥ 25°C)	I _F / °C	-0.66	mA / °C
	Reverse Voltage	V _R	5	V
DETECTOR	Supply Voltage	V _{CC}	7	V
	Output Voltage	V _O	7	V
	Output Current	I _O L	10	mA
Operating Temperature		T _{opr}	-25~85	°C
Storage Temperature		T _{stg}	-40~100	°C
Soldering Temperature (5 s) (Note 1)		T _{sol}	260	°C

(Note 1) : Soldering is performed 1.5 mm from the bottom of the package.

RECOMMENDED OPERATING CONDITIONS

CHARACTERISTIC	SYMBOL	Min	Typ.	Max	UNIT
Forward Current	I _F	12(*)	—	20	mA
Supply Voltage	V _{CC}	2.4	—	7	V
Output Voltage	V _O	—	—	7	V
Low Level Output Current	I _O L	—	—	10	mA

(*) : The value 12mA takes account of 50% LED optical fluctuation.
The initial value of the threshold input current is 6 mA max.

OPTICAL AND ELECTRICAL CHARACTERISTICS

(Ta = -25°C~85°C, VCC = 2.4~7V, Typical values are all at 25°C)

CHARACTERISTIC		SYMBOL	TEST CONDITION	Min	Typ.	Max	UNIT	
LED	Forward Voltage	V_F	$I_F = 10 \text{ mA}$, $T_a = 25^\circ\text{C}$	1.0	1.15	1.3	V	
	Reverse Current	I_R	$V_R = 5 \text{ V}$, $T_a = 25^\circ\text{C}$	—	0.01	10	μA	
	Peak Emission Wavelength	λ_P	$I_F = 10 \text{ mA}$	—	940	—	nm	
DETECTOR	Supply Voltage	V_{CC}	—	2.4	—	7	V	
	Low Level Supply Current	I_{CCL}	$I_F = 10 \text{ mA}$	—	1.0	3.5	mA	
	High Level Supply Current	I_{CCH}		—	1.3	3.2	mA	
	Low Level Output Voltage	V_{OL}	$I_F = 10 \text{ mA}$, $I_{OL} = 10 \text{ mA}$	—	0.06	0.4	V	
	High Level Output Current	I_{OH}	$V_O = 7 \text{ V}$	—	—	30	μA	
	Peak Sensitivity Wavelength	λ_P	$T_a = 25^\circ\text{C}$	—	870	—	nm	
	COUPLED	Threshold Input Current (H → L)	I_{FHL}		—	—	6	mA
Hysteresis Ratio		I_{FHL}/I_{FLH}	$T_a = 25^\circ\text{C}$	—	1.25	—	—	
Switching Time		Propagation Delay Time (H → L)	t_{PHL}	$I_F = 10 \text{ mA}$, $R_L = 750 \Omega$, $T_a = 25^\circ\text{C}$ (Note 2)	—	4	—	μs
		Propagation Delay Time (L → H)	t_{PLH}		—	26	—	
		Rise Time	t_r		—	0.07	—	
	Fall Time	t_f	—		0.08	—		

(Note 2) : Switching time measurement circuit and waveform

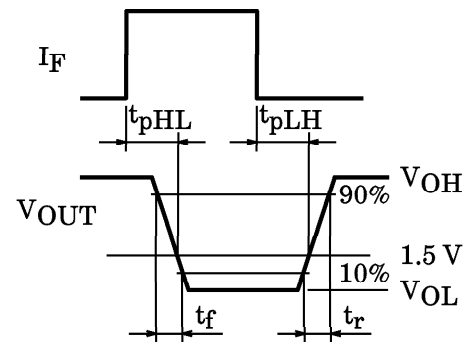
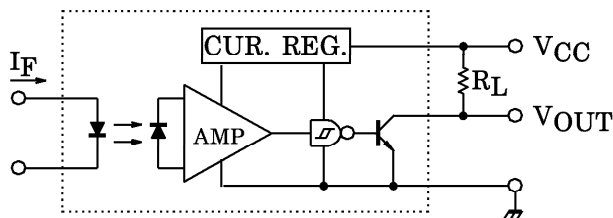

PRECAUTIONS

1. When removing flux with chemicals after soldering, clean only the soldered part of the leads. Do not immerse the entire package in the cleaning solvent. Chemical residue on the LED emitter or the photodetector inside the photo-IC case may adversely affect the optical characteristics of the device and may drastically reduce the threshold input current.
2. Oil or chemicals may cause the package to melt or crack. Care must be taken in relation to the environment in which the device is to be installed.
3. Mount the device on a level surface.
4. The photo-IC has a highly sensitive amp built in. To stabilize the power line, insert a bypass capacitor of up to 0.01 μF between V_{CC} and GND, close the device.
5. The threshold input current increases over time due to current flowing in the infrared LED. The design of circuits which incorporate the device must take into account the change in threshold input current over time.
6. At power-on the internal circuit takes about 100 μs to stabilize. During this period the output signal is unstable and may change.
7. The package should not be subjected to stress, since this may result in package deformation or have other deleterious effects.
8. The threshold input current increases over time due to current flowing in the infrared LED. The design of circuits which incorporate the device must take into account the change in threshold input current over time. The change in threshold input current is equal to the reciprocal of the change in LED infrared optical output.

$$\frac{I_{\text{FHL}}(t)}{I_{\text{FHL}}(0)} = \left(\frac{P_{\text{O}}(t)}{P_{\text{O}}(0)} \right)^{-1}$$

PACKAGE DIMENSIONS
11-4G1

Unit : mm

Tolerance : ± 0.2 mm unless otherwise specified
Values in parentheses () are for reference.
The remaining gate should be 0.2 mm or less.

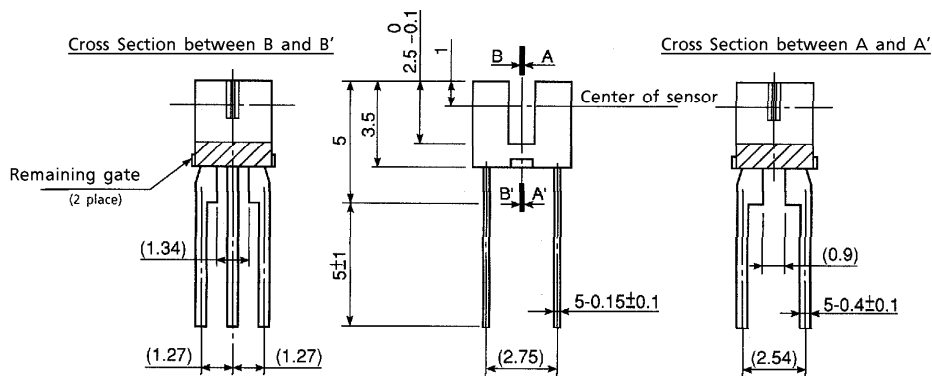
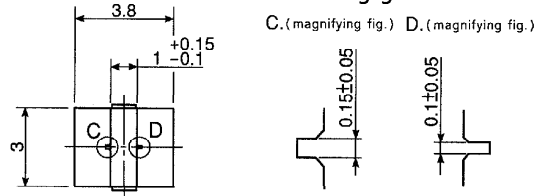

() : Reference value

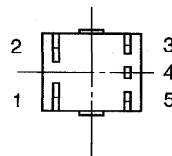

Weight : 0.09 g (typ.)

PIN CONNECTION

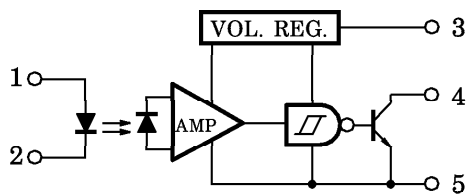

- 1. ANODE
- 2. CATHODE
- 3. VCC
- 4. OUT
- 5. GND

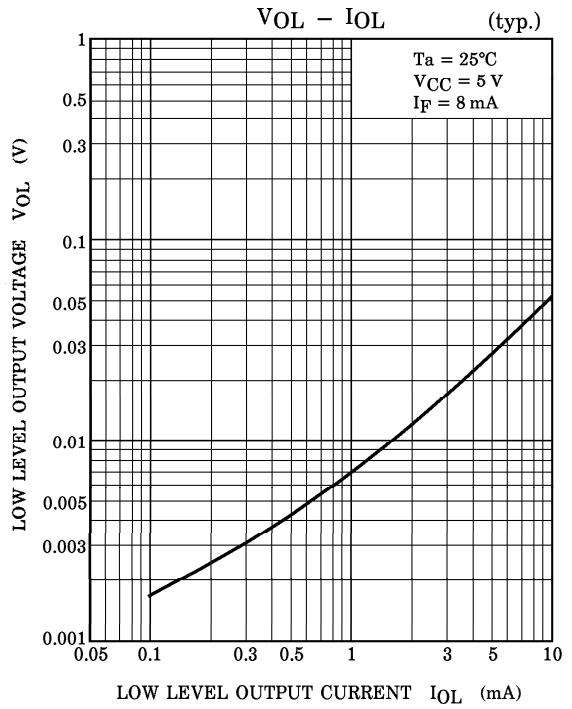
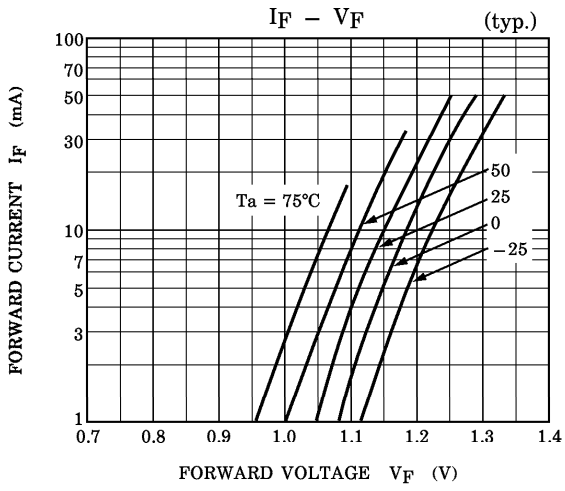
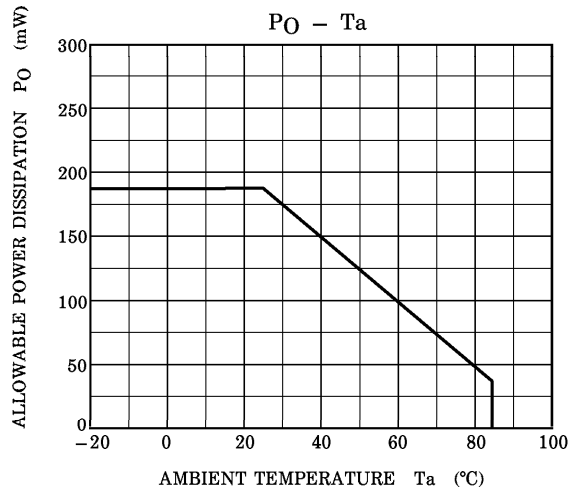
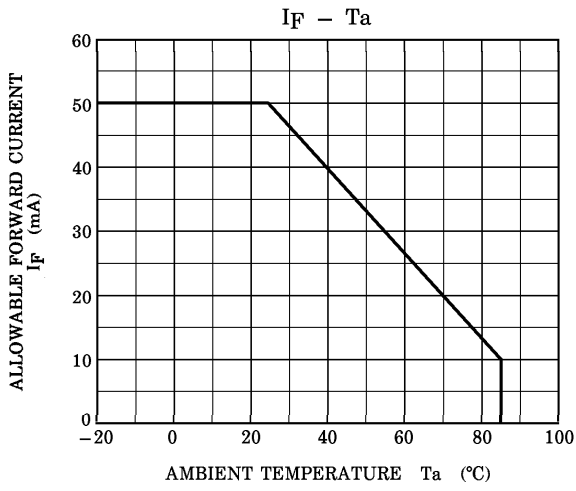

$t_{pLH}, t_{pHL} - I_F$ (typ.)

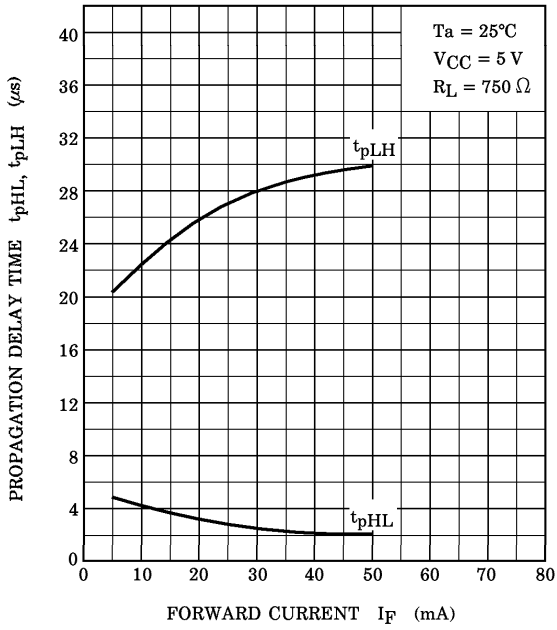

$t_r, t_f - R_L$ (typ.)

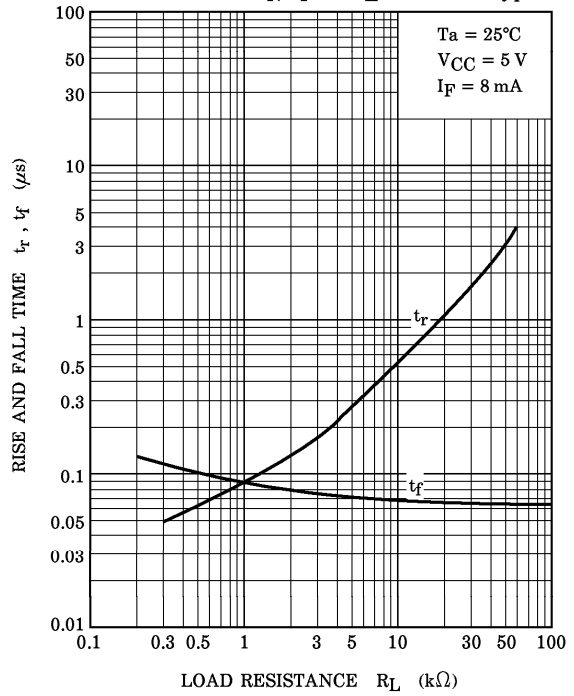

$t_{pLH}, t_{pHL} - R_L$ (typ.)

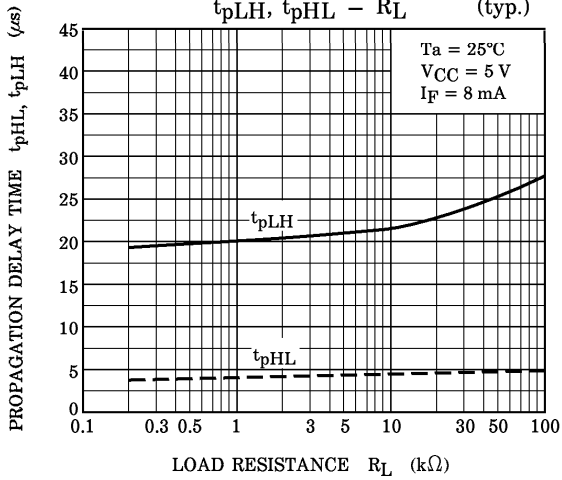

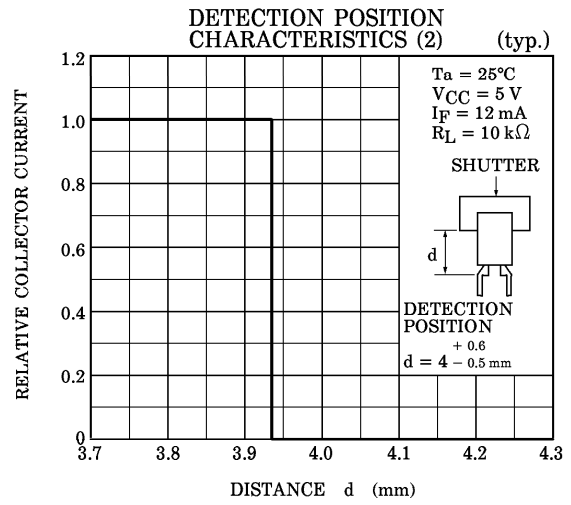
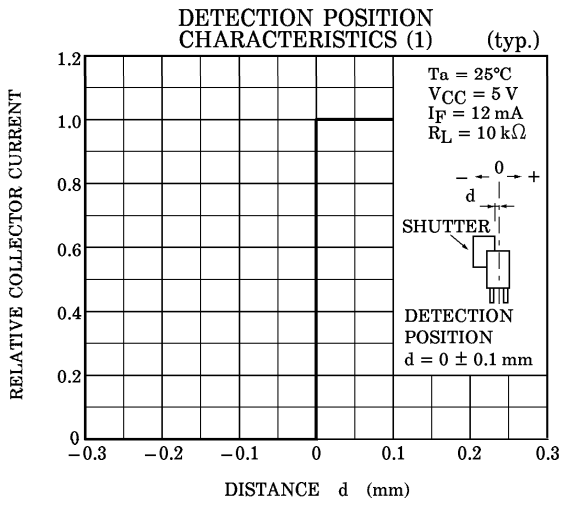

RELATIVE POSITIONING OF SHUTTER AND DEVICE

For normal operation position the shutter and the device as shown in the figure below. By considering the device's detection position characteristic and switching time, determine the shutter slit width and pitch.

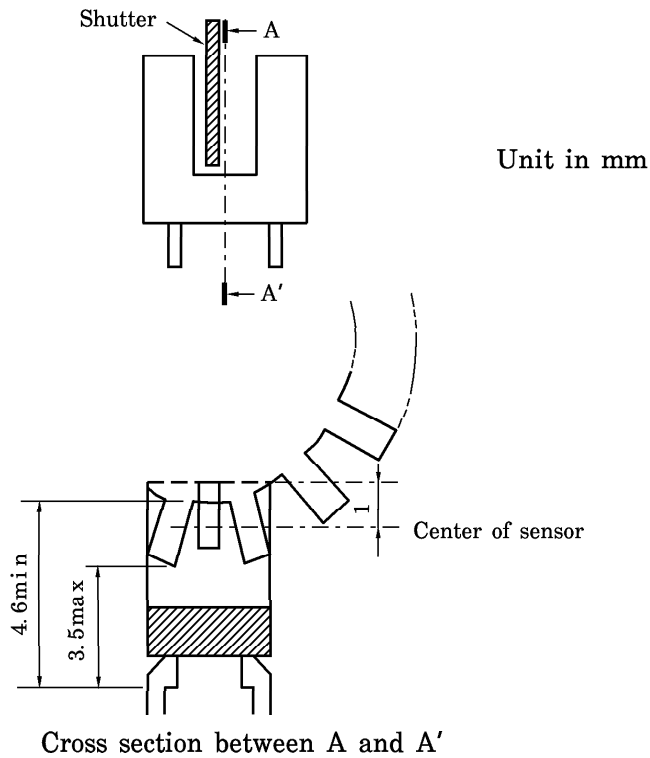

RESTRICTIONS ON PRODUCT USE

000707EAC

- TOSHIBA is continually working to improve the quality and reliability of its products. Nevertheless, semiconductor devices in general can malfunction or fail due to their inherent electrical sensitivity and vulnerability to physical stress. It is the responsibility of the buyer, when utilizing TOSHIBA products, to comply with the standards of safety in making a safe design for the entire system, and to avoid situations in which a malfunction or failure of such TOSHIBA products could cause loss of human life, bodily injury or damage to property. In developing your designs, please ensure that TOSHIBA products are used within specified operating ranges as set forth in the most recent TOSHIBA products specifications. Also, please keep in mind the precautions and conditions set forth in the "Handling Guide for Semiconductor Devices," or "TOSHIBA Semiconductor Reliability Handbook" etc..
- The TOSHIBA products listed in this document are intended for usage in general electronics applications (computer, personal equipment, office equipment, measuring equipment, industrial robotics, domestic appliances, etc.). These TOSHIBA products are neither intended nor warranted for usage in equipment that requires extraordinarily high quality and/or reliability or a malfunction or failure of which may cause loss of human life or bodily injury ("Unintended Usage"). Unintended Usage include atomic energy control instruments, airplane or spaceship instruments, transportation instruments, traffic signal instruments, combustion control instruments, medical instruments, all types of safety devices, etc.. Unintended Usage of TOSHIBA products listed in this document shall be made at the customer's own risk.
- Gallium arsenide (GaAs) is a substance used in the products described in this document. GaAs dust and fumes are toxic. Do not break, cut or pulverize the product, or use chemicals to dissolve them. When disposing of the products, follow the appropriate regulations. Do not dispose of the products with other industrial waste or with domestic garbage.
- The information contained herein is presented only as a guide for the applications of our products. No responsibility is assumed by TOSHIBA CORPORATION for any infringements of intellectual property or other rights of the third parties which may result from its use. No license is granted by implication or otherwise under any intellectual property or other rights of TOSHIBA CORPORATION or others.
- The information contained herein is subject to change without notice.

This datasheet has been download from:

www.datasheetcatalog.com

Datasheets for electronics components.