

TOSHIBA Photocoupler GaAs Ired & Photo-Triac

TLP3527

Triac Driver
 Programmable Controllers
 AC-Output Module
 Solid State Relay

The TOSHIBA TLP3527 consists of a zero voltage crossing turn-on photo-triac optically coupled to a gallium arsenide infrared emitting diode in a 16 lead plastic DIP package.

- Peak off-state voltage: 600V (min.)
- Trigger LED current: 10mA (max.)
- On-state current: 1.0A_{rms} (max.)
- Isolation voltage: 2500V_{rms} (min.)
- UL recognized: UL1577, file No.E67349

Unit in mm

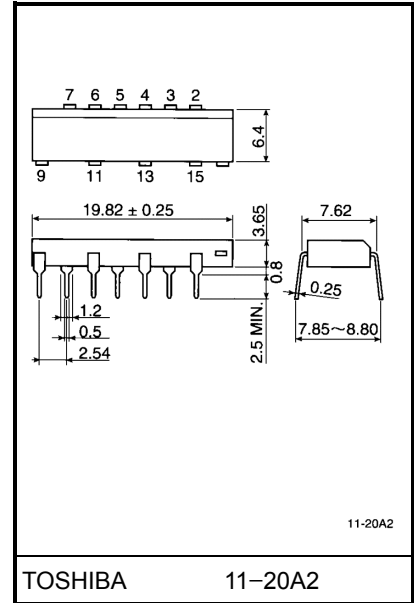

Weight: 1.13g

Pin Configurations (top view)

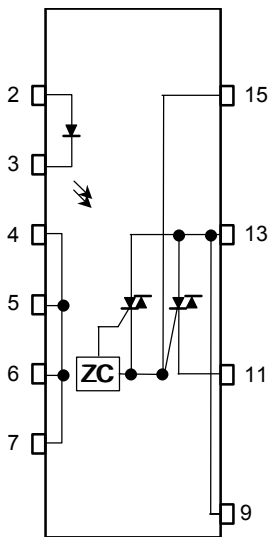

- 2 : Anode
- 3 : Cathode
- 4,5,6,7 : N.C.
- 9,13 : Triac T2
- 11 : Triac T1
- 15 : Triac gate

Maximum Ratings (Ta = 25°C)

Characteristic		Symbol	Rating	Unit	
LED	Forward current	I_F	50	mA	
	Forward current derating (Ta ≥ 53°C)	$\Delta I_F / ^\circ\text{C}$	-0.7	mA / °C	
	Peak forward current (100µs pulse, 100pps)	I_{FP}	1	A	
	Reverse voltage	V_R	5	V	
	Junction temperature	T_j	125	°C	
Detector	Off-state output terminal voltage	V_{DRM}	600	V	
	On-state RMS current	Ta=40°C	I_T (RMS)	1.0	A
		Ta=60°C		0.7	
	On-state current derating (Ta ≥ 40°C)	$\Delta I_T / ^\circ\text{C}$	-14.3	mA / °C	
	Peak current from snubber circuit (100µs pulse, 120pps)	I_{SP}	2	A	
	Peak nonrepetitive surge current (50Hz, peak)	I_{TSM}	10	A	
	Junction temperature	T_j	110	°C	
Storage temperature range	T_{stg}	-40~125	°C		
Operating temperature range	T_{opr}	-20~80	°C		
Lead soldering temperature (10s)	T_{sol}	260	°C		
Isolation voltage (AC, 1min., R.H. ≤ 60%) (Note)	BV_S	2500	V_{rms}		

(Note) Device considered a two terminal: LED side pins shorted together and detector side pins shorted together.

Recommended Operating Conditions

Characteristic	Symbol	Min.	Typ.	Max.	Unit
Supply voltage	V_{AC}	—	—	240	V_{ac}
Forward current	I_F	15	20	25	mA
Peak current from snubber circuit	I_{SP}	—	—	1	A
Operating temperature	T_{opr}	-20	—	80	°C

Individual Electrical Characteristics (Ta = 25°C)

Characteristic		Symbol	Test Condition	Min.	Typ.	Max.	Unit
LED	Forward voltage	V_F	$I_F=10\text{mA}$	1.0	1.15	1.3	V
	Reverse current	I_R	$V_R=5\text{V}$	—	—	10	μA
	Capacitance	C_T	$V=0, f=1\text{MHz}$	—	30	—	pF
Detector	Peak off-state current	I_{DRM}	$V_{DRM}=600\text{V}, T_a=110^\circ\text{C}$	—	—	100	μA
	Peak on-state voltage	V_{TM}	$I_{TM}=1.5\text{A}$	—	—	3.0	V
	Holding current	I_H	$R_L=100\Omega$	—	—	25	mA
	Critical rate of rise of off-state voltage	dv/dt	$V_{in}=240\text{V}_{rms}$ (fig.1)	—	500	—	V / μs
	Critical rate of rise of commutating voltage	$dv/dt(c)$	$V_{in}=240\text{V}_{rms}, I_T=1.0\text{A}_{rms}$ (fig.1)	—	5	—	V / μs

Coupled Electrical Characteristics (Ta = 25°C)

Characteristic	Symbol	Test Condition	Min.	Typ.	Max.	Unit
Trigger LED current	I_{FT}	$V_T=6\text{V}$	—	—	10	mA
Inhibit voltage	V_{IH}	$I_F=\text{Rated } I_{FT}$	—	—	50	V
Leakage in inhibited state	I_{IH}	$I_F=\text{Rated } I_{FT}$ $V_T=\text{Rated } V_{DRM}$	—	200	—	μA
Capacitance (input to output)	C_S	$V_S=0, f=1\text{MHz}$	—	1.5	—	pF
Isolation resistance	R_S	$V_S=500\text{V}$	5×10^{10}	10^{14}	—	Ω
Isolation voltage	BV_S	AC, 1 minute	2500	—	—	V_{rms}
		AC, 1 second, in oil	—	5000	—	
		DC, 1 minute, in oil	—	5000	—	V_{dc}

Fig.1: dv/dt test circuit

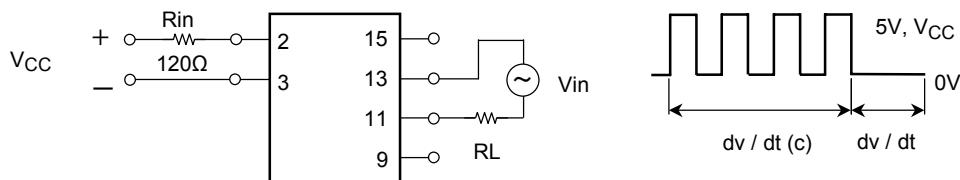

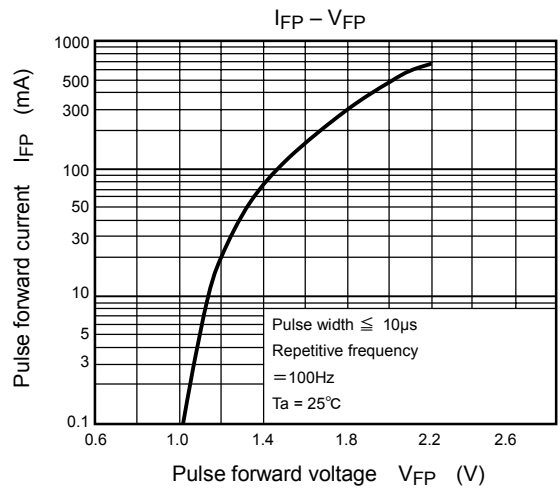
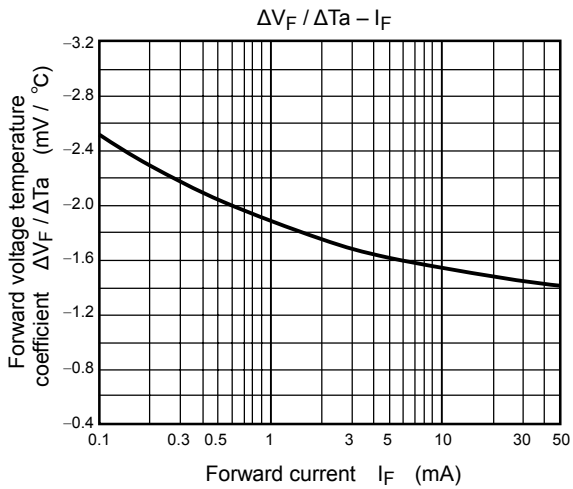
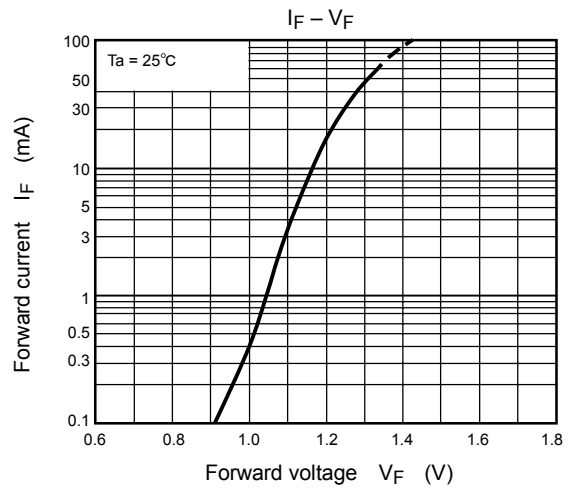
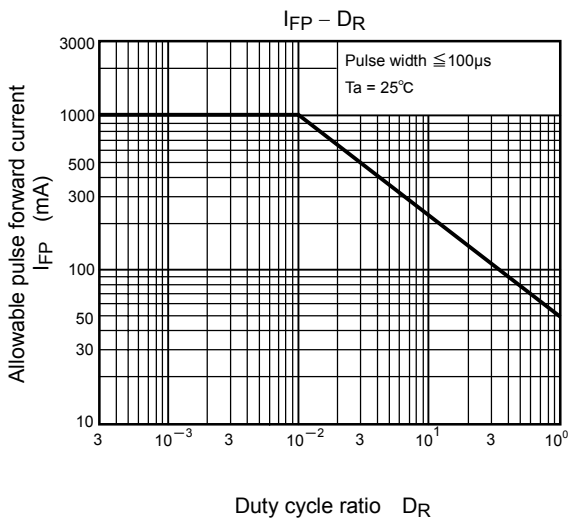
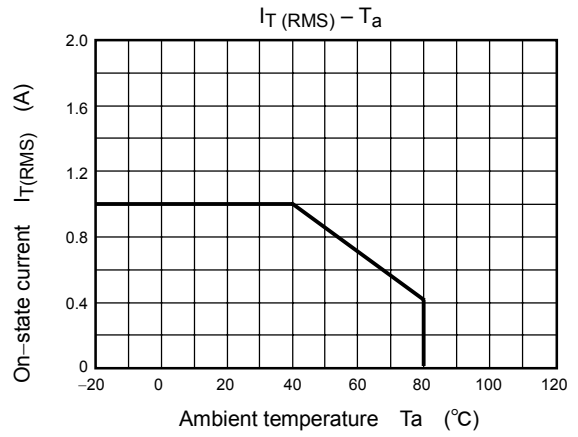
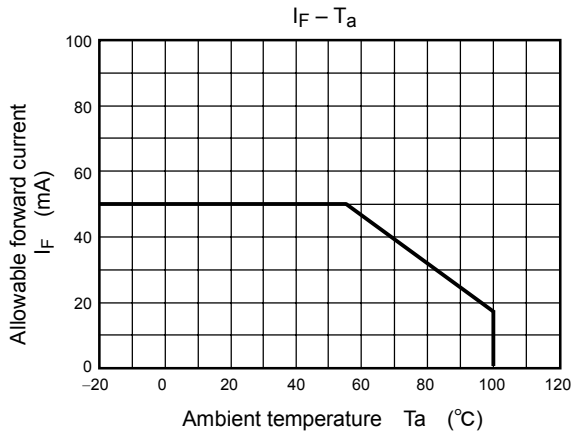

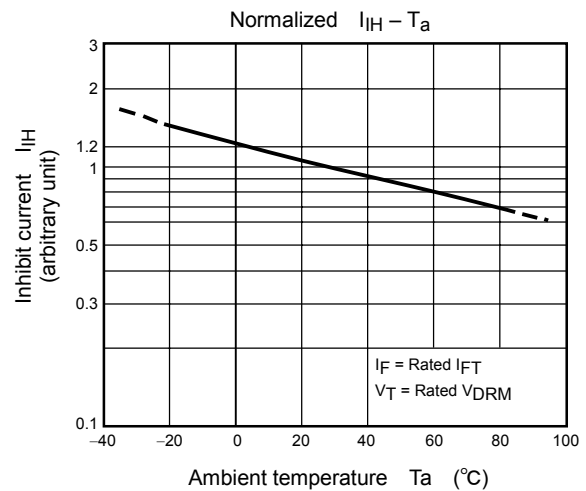
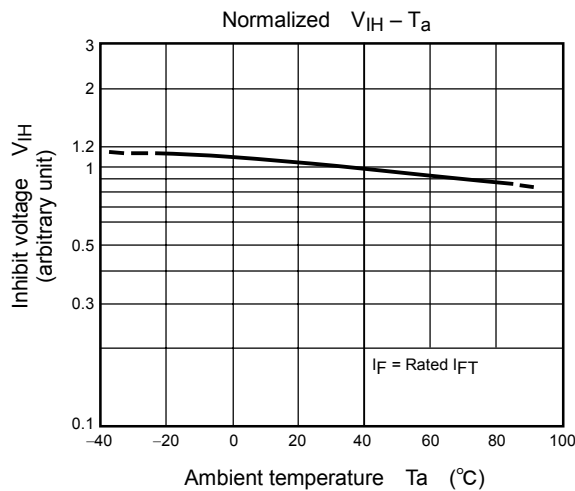
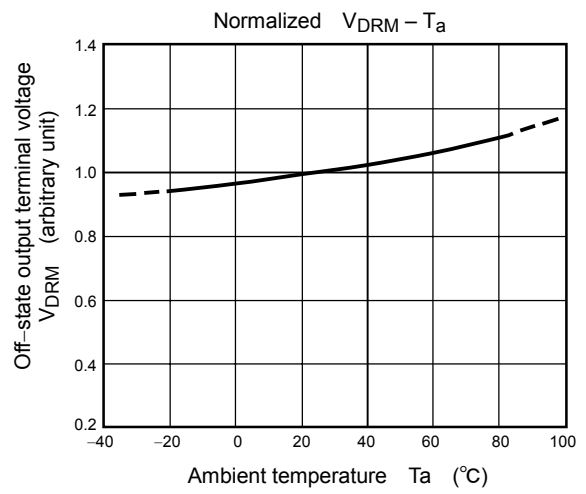
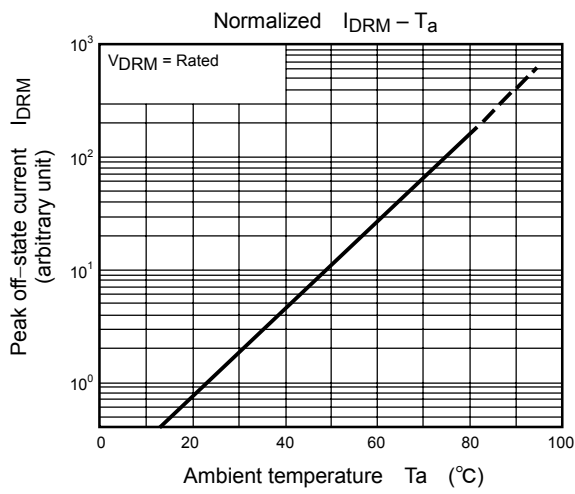
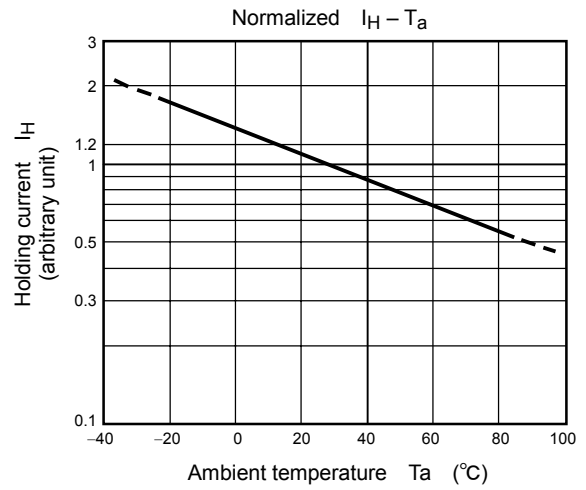
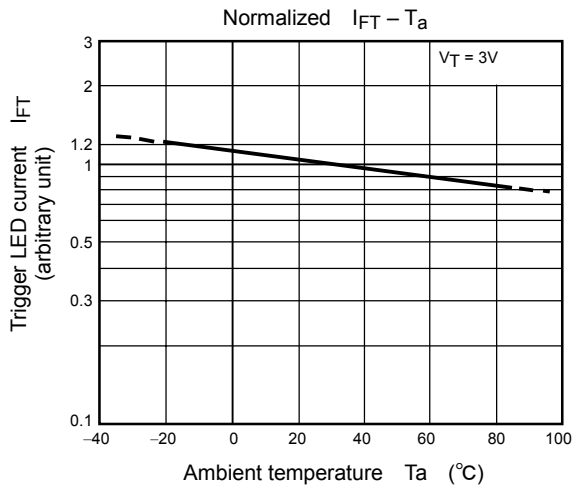

RESTRICTIONS ON PRODUCT USE

000707EBC

- TOSHIBA is continually working to improve the quality and reliability of its products. Nevertheless, semiconductor devices in general can malfunction or fail due to their inherent electrical sensitivity and vulnerability to physical stress. It is the responsibility of the buyer, when utilizing TOSHIBA products, to comply with the standards of safety in making a safe design for the entire system, and to avoid situations in which a malfunction or failure of such TOSHIBA products could cause loss of human life, bodily injury or damage to property.
In developing your designs, please ensure that TOSHIBA products are used within specified operating ranges as set forth in the most recent TOSHIBA products specifications. Also, please keep in mind the precautions and conditions set forth in the "Handling Guide for Semiconductor Devices," or "TOSHIBA Semiconductor Reliability Handbook" etc..
- The TOSHIBA products listed in this document are intended for usage in general electronics applications (computer, personal equipment, office equipment, measuring equipment, industrial robotics, domestic appliances, etc.). These TOSHIBA products are neither intended nor warranted for usage in equipment that requires extraordinarily high quality and/or reliability or a malfunction or failure of which may cause loss of human life or bodily injury ("Unintended Usage"). Unintended Usage include atomic energy control instruments, airplane or spaceship instruments, transportation instruments, traffic signal instruments, combustion control instruments, medical instruments, all types of safety devices, etc.. Unintended Usage of TOSHIBA products listed in this document shall be made at the customer's own risk.
- Gallium arsenide (GaAs) is a substance used in the products described in this document. GaAs dust and fumes are toxic. Do not break, cut or pulverize the product, or use chemicals to dissolve them. When disposing of the products, follow the appropriate regulations. Do not dispose of the products with other industrial waste or with domestic garbage.
- The products described in this document are subject to the foreign exchange and foreign trade laws.
- The information contained herein is presented only as a guide for the applications of our products. No responsibility is assumed by TOSHIBA CORPORATION for any infringements of intellectual property or other rights of the third parties which may result from its use. No license is granted by implication or otherwise under any intellectual property or other rights of TOSHIBA CORPORATION or others.
- The information contained herein is subject to change without notice.