

TLP513

Line Receiver
 Microprocessor System Interface
 Data transfers between circuits of different potentials
 Computer Terminal Interface
 Ground Loop Elimination

TLP513 is a 6-PIN DIP photocoupler, which consists of an infrared emitting diode and a high-gain, high-speed IC detector chip. It has a Schottky clamped transistor and has an open collector output type.

- Threshold input current : $I_F = 5 \text{ mA (max)}$
- Switching Speed : 10 MBd
- Guaranteed performance over temperature: 0 to 70°C
- Isolation voltage : 2500 V_{rms} (min)
- UL-recognized : UL 1577, File No.E67349

Truth Table (positive Logic)

Input	Output
H	L
L	H

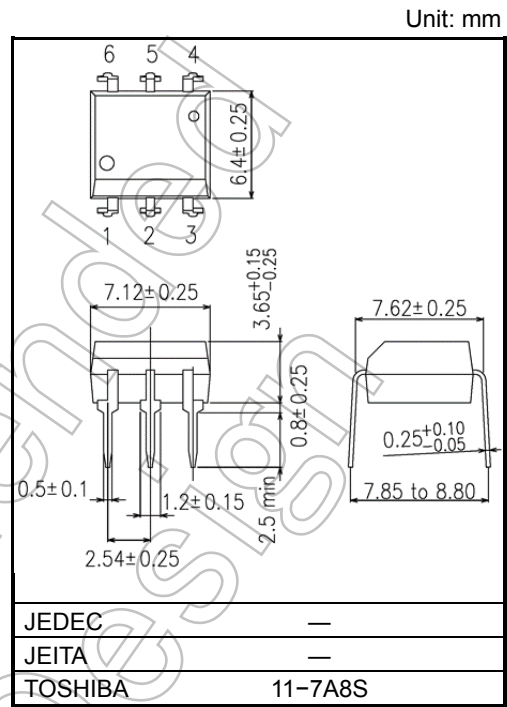

Weight: 0.4 g (typ.)

Pin Configuration (top View)

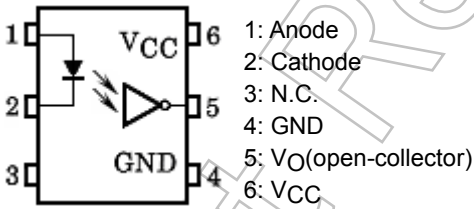

Schematic

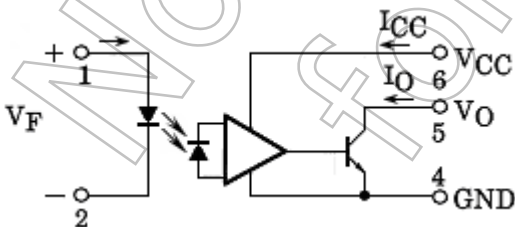

Note: A 0.1 μF bypass capacitor must be connected between pins 6 and 4.

Start of commercial production
 1987-09

Absolute Maximum Rating (Ta = 25°C)

Characteristics		Symbol	Rating	Unit
LED	Forward current	I_F	20	mA
	Forward current derating (Ta ≥ 85°C)	$\Delta I_F / \Delta T_a$	-1.6	mA/°C
	Pulse forward current (Note 1)	I_{FP}	40	mA
	Peak transient forward current (Note 2)	I_{FPT}	1	A
	Reverse voltage	V_R	5	V
	Input power dissipation	P_D	100	mW
	Input power dissipation derating (Ta ≥ 85°C)	$\Delta P_D / ^\circ C$	-2.5	mW/°C
Detector	Output current	I_O	25	mA
	Output voltage	V_O	7	V
	Supply voltage (Note 3)	V_{CC}	7	V
	Output power dissipation	P_O	40	mW
	Output power dissipation derating (Ta ≥ 85°C)	$\Delta P_O / \Delta T_a$	-1.0	mW/°C
Storage temperature range		T_{stg}	-55 to 125	°C
Operating temperature range		T_{opr}	-40 to 85	°C
Lead solder temperature (10 s) (Note 4)	T_{sol}	260	°C	
Isolation voltage (Note 5)		BV_S	2500	V_{rms}

Note: Using continuously under heavy loads (e.g. application of high temperature/current/voltage and a significant change in temperature, etc.) may cause this product to decrease in reliability significantly even if the operating conditions (i.e. operating temperature/current/voltage, etc.) are within the absolute maximum ratings.

Please design the appropriate reliability upon reviewing the Toshiba Semiconductor Reliability Handbook (“Handling Precautions”/“Derating Concept and Methods”) and individual reliability data (i.e. reliability test report and estimated failure rate, etc).

Note 1: 50 % duty cycle, 1 ms pulse width.

Note 2: Pulse width ≤ 1 μs, 300 pps.

Note 3: 1 minute maximum.

Note 4: Soldering is performed 2mm from the bottom of the package.

Note 5: AC, 60 s, R.H. ≤ 60 %

Device considered a two-terminal device: 1, 2 and 3 shorted together and pins 4, 5 and 6 shorted together.

Recommended Operating Conditions

Characteristics	Symbol	Min	Typ.	Max	Unit
'L' level input voltage	V_{FL}	-3	0	1.0	V
'H' level input current	I_{FH}	6.3*	8	20	mA
Supply voltage**	V_{CC}	4.5	5	5.5	V
Fan-out (TTL load)	N	—	—	8	—
Operating temperature	T_{opr}	0	—	70	°C

Note: The recommended operating conditions are given as a design guideline to obtain the expected performance of the device. In addition, each item is an independent guideline. In developing designs using this product, please confirm the specified characteristics shown in this document.

* 6.3 mA is a guard banded value which allows for at least 20 % CTR degradation.
Initial input current threshold is 5 mA or less.

** This item denotes the operating range and not the recommended operating conditions.

Electrical Characteristics

(Unless otherwise specified Ta = 0 to 70°C, VCC = 4.5 to 5.5 V, VFL ≤ 1.0 V)

Characteristics	Symbol	Test Conditions	Min	Typ.*	Max	Unit
Forward voltage	V _F	I _F = 10 mA, Ta = 25 °C	—	1.65	1.8	V
Temperature coefficient of forward voltage	ΔV _F / ΔTa	I _F = 10 mA	—	-2.0	—	mV / °C
Input reverse current	I _R	V _R = 5 V, Ta = 25 °C	—	—	10	μA
Input capacitance	C _T	V _F = 0 V, f = 1 MHz, Ta = 25 °C	—	45	—	pF
“H” level output current	I _{OH}	V _F = 1.0 V, V _O = 5.5 V	—	—	250	μA
		V _F = 1.0 V, V _O = 5.5 V, Ta = 25 °C	—	0.5	10	
“L” level output voltage	V _{OL}	I _F = 5 mA, I _{OL} = 13 mA (sinking)	—	0.4	0.6	V
“H→L” threshold input current	I _{FH}	I _{OL} = 13 mA (sinking), V _{OL} = 0.6 V	—	—	5	mA
“H” level supply current	I _{CCH}	V _{CC} = 5.5 V, I _F = 0 mA	—	7	15	mA
“L” level supply current	I _{CCL}	V _{CC} = 5.5 V, I _F = 10 mA	—	12	18	mA
Isolation resistance	R _S	V _S = 500 V, R.H. ≤ 60 %, Ta = 25 °C (Note 7)	5 × 10 ¹⁰	10 ¹⁴	—	Ω
Input to output capacitance	C _S	V _S = 0 V, f = 1 MHz, Ta = 25 °C (Note 7)	—	0.6	—	pF

* : All typical values are at Ta = 25°C.

Switching Characteristics (Ta = 25°C, VCC = 5 V)

Characteristics	Symbol	Test Circuit	Test Condition	Min	Typ.	Max	Unit
Propagation delay time (H→L)	t _{pHL}	1	I _F = 0 → 7.5 mA, R _L = 350 Ω, C _L = 15 pF	—	60	120	ns
Propagation delay time (L→H)	t _{pLH}		I _F = 7.5 → 0 mA, R _L = 350 Ω, C _L = 15 pF	—	60	120	ns
Rise time, fall time (10 to 90%)	t _r , t _f		I _F = 0 → 7.5 mA, R _L = 350 Ω, C _L = 15 pF	—	30	—	ns
Common mode transient immunity at high level output	CM _H	2	I _F = 0 mA, R _L = 350 Ω, V _{CM} = 200 V, V _O (min) = 2 V (Note 8)	—	200	—	V / μs
Common mode transient immunity at low level output	CM _L		I _F = 7.5 mA, R _L = 350 Ω, V _{CM} = 200 V, V _O (max) = 0.8 V (Note 9)	—	-500	—	V / μs

Note 6: The V_{CC} supply voltage to each TLP513 isolator must be bypassed by a 0.1 μF capacitor. This can be either a ceramic or solid tantalum capacitor with good high frequency characteristic and should be connected as close as possible to the V_{CC} and GND pins of each device.

Note 7: Device considered a 2-terminal device: Pins 1, 2 and 3 shorted together, and pins 4, 5 and 6 shorted together.

Note 8: CM_H: The maximum tolerable rate of rise of the common mode voltage to ensure the output will remain in the high output state (i.e., V_O > 2.0 V). Measured in volts per microsecond (V / μs).

Note 9: CM_L: The maximum tolerable rate of fall of the common mode voltage to ensure the output will remain in the low output state (i.e., V_O < 0.8 V). Measured in volts per microsecond (V / μs).

Test Circuit 1: Switching Time Test Circuit

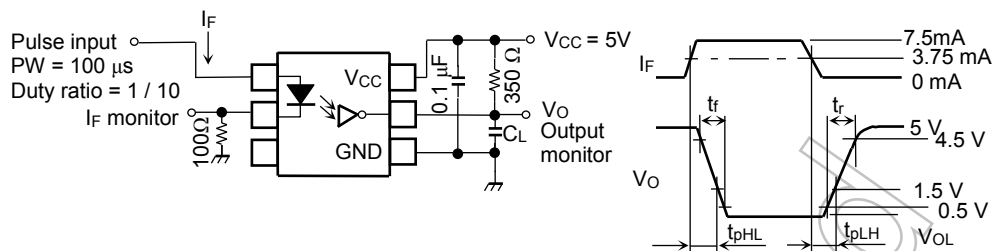

C_L is approximately 15 pF which includes probe and stray wiring

Test Circuit 2: Common Mode Noise Immunity Test Circuit

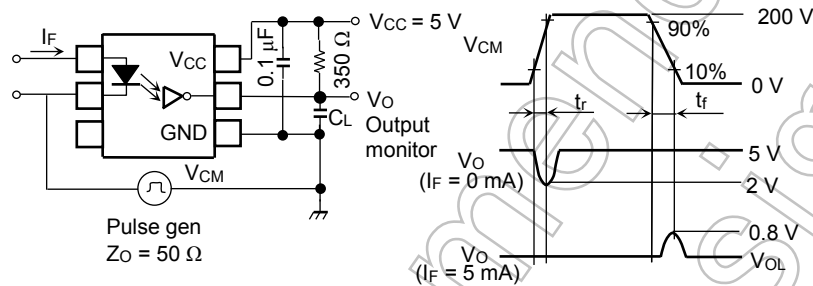

$$CM_H = \frac{160 \text{ (V)}}{t_r \text{ (}\mu\text{s)}}, \quad CM_L = \frac{160 \text{ (V)}}{t_f \text{ (}\mu\text{s)}}$$

C_L is approximately 15 pF which includes probe and stray wiring

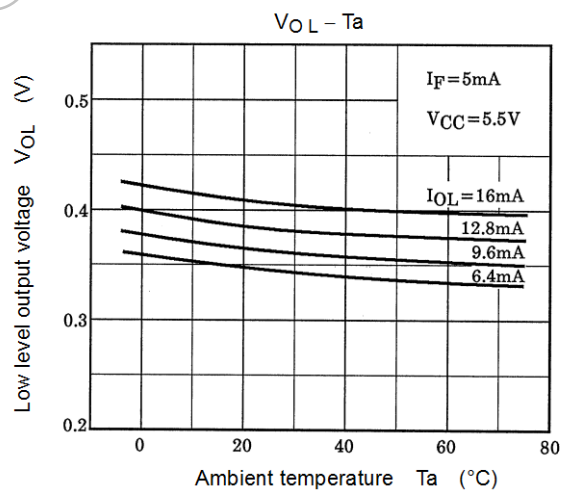
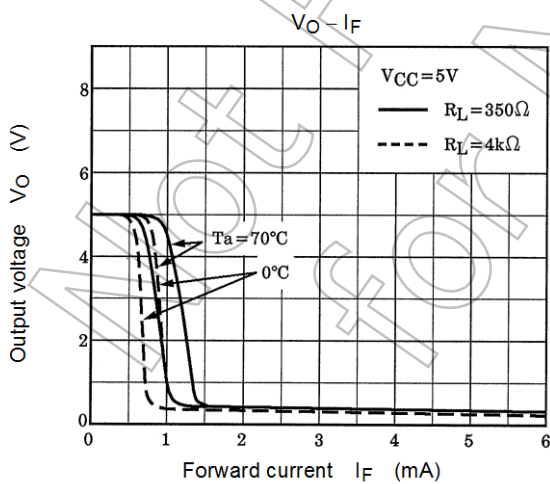
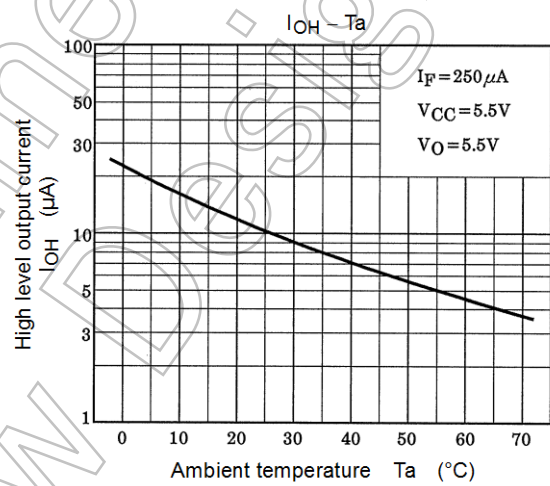
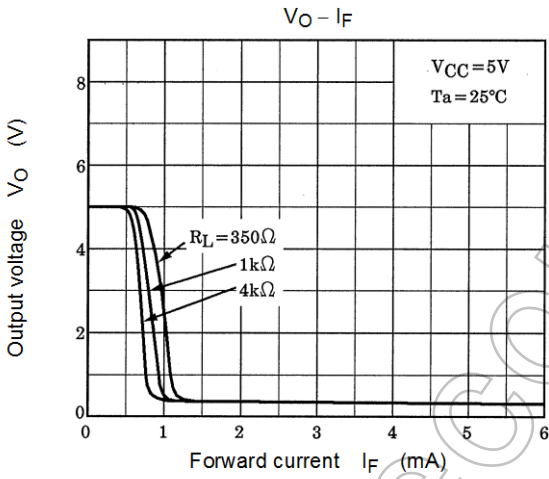
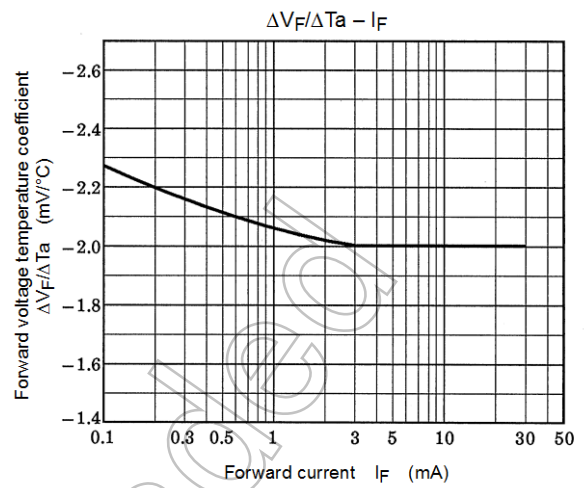
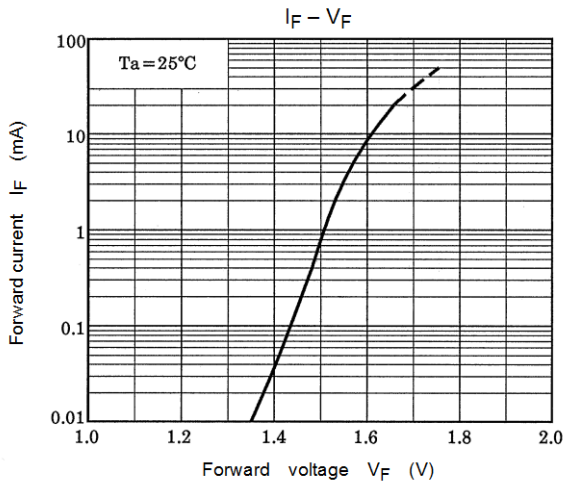

NOTE: The above characteristics curves are presented for reference only and not guaranteed by production test, unless otherwise noted.

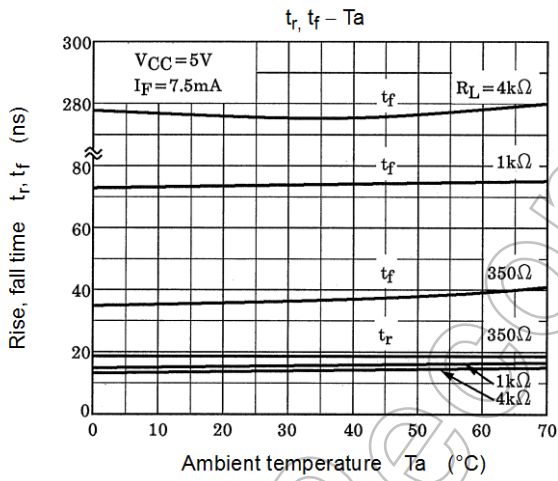
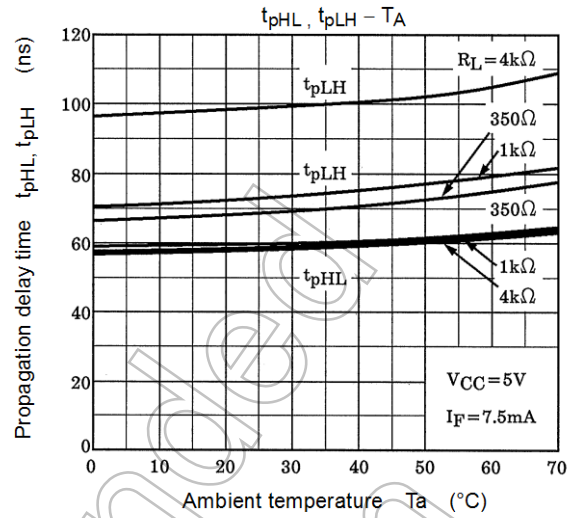
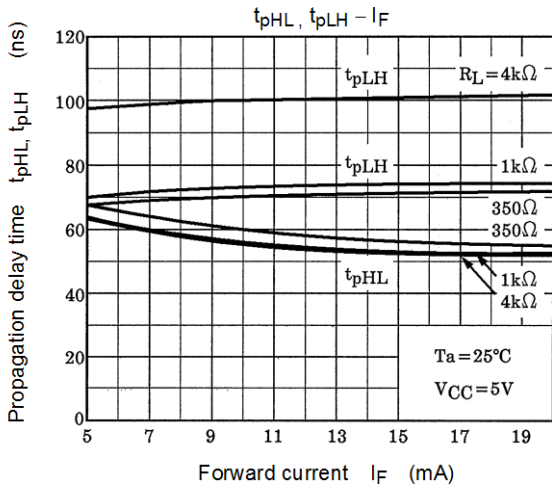

NOTE: The above characteristics curves are presented for reference only and not guaranteed by production test, unless otherwise noted.

RESTRICTIONS ON PRODUCT USE

Toshiba Corporation and its subsidiaries and affiliates are collectively referred to as "TOSHIBA". Hardware, software and systems described in this document are collectively referred to as "Product".

- TOSHIBA reserves the right to make changes to the information in this document and related Product without notice.
- This document and any information herein may not be reproduced without prior written permission from TOSHIBA. Even with TOSHIBA's written permission, reproduction is permissible only if reproduction is without alteration/omission.
- Though TOSHIBA works continually to improve Product's quality and reliability, Product can malfunction or fail. Customers are responsible for complying with safety standards and for providing adequate designs and safeguards for their hardware, software and systems which minimize risk and avoid situations in which a malfunction or failure of Product could cause loss of human life, bodily injury or damage to property, including data loss or corruption. Before customers use the Product, create designs including the Product, or incorporate the Product into their own applications, customers must also refer to and comply with (a) the latest versions of all relevant TOSHIBA information, including without limitation, this document, the specifications, the data sheets and application notes for Product and the precautions and conditions set forth in the "TOSHIBA Semiconductor Reliability Handbook" and (b) the instructions for the application with which the Product will be used with or for. Customers are solely responsible for all aspects of their own product design or applications, including but not limited to (a) determining the appropriateness of the use of this Product in such design or applications; (b) evaluating and determining the applicability of any information contained in this document, or in charts, diagrams, programs, algorithms, sample application circuits, or any other referenced documents; and (c) validating all operating parameters for such designs and applications. **TOSHIBA ASSUMES NO LIABILITY FOR CUSTOMERS' PRODUCT DESIGN OR APPLICATIONS.**
- **PRODUCT IS NEITHER INTENDED NOR WARRANTED FOR USE IN EQUIPMENTS OR SYSTEMS THAT REQUIRE EXTRAORDINARILY HIGH LEVELS OF QUALITY AND/OR RELIABILITY, AND/OR A MALFUNCTION OR FAILURE OF WHICH MAY CAUSE LOSS OF HUMAN LIFE, BODILY INJURY, SERIOUS PROPERTY DAMAGE AND/OR SERIOUS PUBLIC IMPACT ("UNINTENDED USE").** Except for specific applications as expressly stated in this document, Unintended Use includes, without limitation, equipment used in nuclear facilities, equipment used in the aerospace industry, lifesaving and/or life supporting medical equipment, equipment used for automobiles, trains, ships and other transportation, traffic signaling equipment, equipment used to control combustions or explosions, safety devices, elevators and escalators, and devices related to power plant. **IF YOU USE PRODUCT FOR UNINTENDED USE, TOSHIBA ASSUMES NO LIABILITY FOR PRODUCT.** For details, please contact your TOSHIBA sales representative or contact us via our website.
- Do not disassemble, analyze, reverse-engineer, alter, modify, translate or copy Product, whether in whole or in part.
- Product shall not be used for or incorporated into any products or systems whose manufacture, use, or sale is prohibited under any applicable laws or regulations.
- The information contained herein is presented only as guidance for Product use. No responsibility is assumed by TOSHIBA for any infringement of patents or any other intellectual property rights of third parties that may result from the use of Product. No license to any intellectual property right is granted by this document, whether express or implied, by estoppel or otherwise.
- **ABSENT A WRITTEN SIGNED AGREEMENT, EXCEPT AS PROVIDED IN THE RELEVANT TERMS AND CONDITIONS OF SALE FOR PRODUCT, AND TO THE MAXIMUM EXTENT ALLOWABLE BY LAW, TOSHIBA (1) ASSUMES NO LIABILITY WHATSOEVER, INCLUDING WITHOUT LIMITATION, INDIRECT, CONSEQUENTIAL, SPECIAL, OR INCIDENTAL DAMAGES OR LOSS, INCLUDING WITHOUT LIMITATION, LOSS OF PROFITS, LOSS OF OPPORTUNITIES, BUSINESS INTERRUPTION AND LOSS OF DATA, AND (2) DISCLAIMS ANY AND ALL EXPRESS OR IMPLIED WARRANTIES AND CONDITIONS RELATED TO SALE, USE OF PRODUCT, OR INFORMATION, INCLUDING WARRANTIES OR CONDITIONS OF MERCHANTABILITY, FITNESS FOR A PARTICULAR PURPOSE, ACCURACY OF INFORMATION, OR NONINFRINGEMENT.**
- GaAs (Gallium Arsenide) is used in Product. GaAs is harmful to humans if consumed or absorbed, whether in the form of dust or vapor. Handle with care and do not break, cut, crush, grind, dissolve chemically or otherwise expose GaAs in Product.
- Do not use or otherwise make available Product or related software or technology for any military purposes, including without limitation, for the design, development, use, stockpiling or manufacturing of nuclear, chemical, or biological weapons or missile technology products (mass destruction weapons). Product and related software and technology may be controlled under the applicable export laws and regulations including, without limitation, the Japanese Foreign Exchange and Foreign Trade Law and the U.S. Export Administration Regulations. Export and re-export of Product or related software or technology are strictly prohibited except in compliance with all applicable export laws and regulations.
- Please contact your TOSHIBA sales representative for details as to environmental matters such as the RoHS compatibility of Product. Please use Product in compliance with all applicable laws and regulations that regulate the inclusion or use of controlled substances, including without limitation, the EU RoHS Directive. **TOSHIBA ASSUMES NO LIABILITY FOR DAMAGES OR LOSSES OCCURRING AS A RESULT OF NONCOMPLIANCE WITH APPLICABLE LAWS AND REGULATIONS.**