

TOSHIBA PHOTO-INTERRUPTER INFRARED LED + PHOTOTRANSISTOR

TLP800A

POSITION AND ROTATION DETECTION

PHOTO-ELECTRIC COUNTERS, EDGE SENSORS

TIMING DETECTION IN COPIERS, PRINTERS, FAX MACHINES, ETC.

The TLP800A photo-interrupter is used for high-speed position detection.

- Gap : 3 mm
- Resolution : Slit width = 1 mm
- Fast response speed : $t_r, t_f = 6 \mu s$ (typ.)
- High current transfer ratio : $I_C / I_F = 10\%$ (min)
- Package material : Polycarbonate

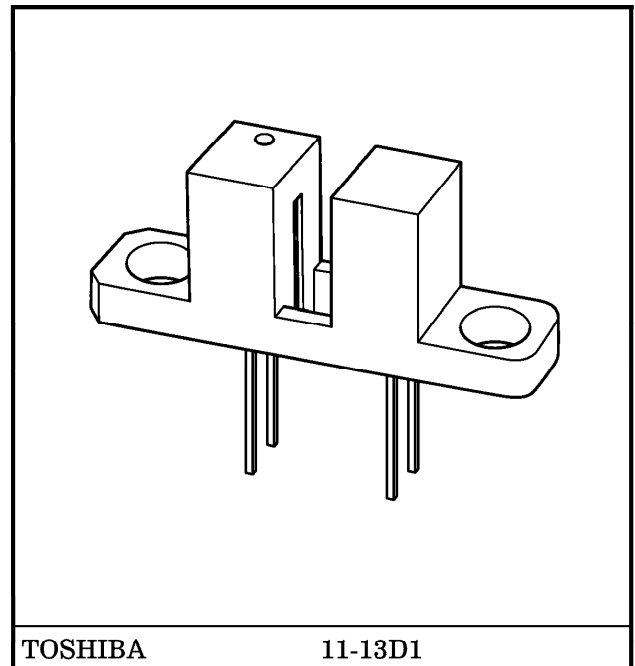

TOSHIBA 11-13D1

Weight : 0.81 g (typ.)

MAXIMUM RATINGS (Ta = 25°C)

CHARACTERISTIC		SYMBOL	RATING	UNIT
LED	Forward Current	I_F	50	mA
	Forward Current Derating (Ta > 25°C)	$\Delta I_F / ^\circ C$	-0.33	mA / °C
	Reverse Voltage	V_R	5	V
DETECTOR	Collector-Emitter Voltage	V_{CEO}	30	V
	Emitter Collector Voltage	V_{ECO}	5	V
	Collector Power Dissipation	P_C	75	mW
	Collector Power Dissipation Derating (Ta > 25°C)	$\Delta P_C / ^\circ C$	-1	mW / °C
	Collector Current	I_C	50	mA
Operating Temperature Range		T_{opr}	-25~85	°C
Storage Temperature Range		T_{stg}	-40~100	°C

MARKINGS

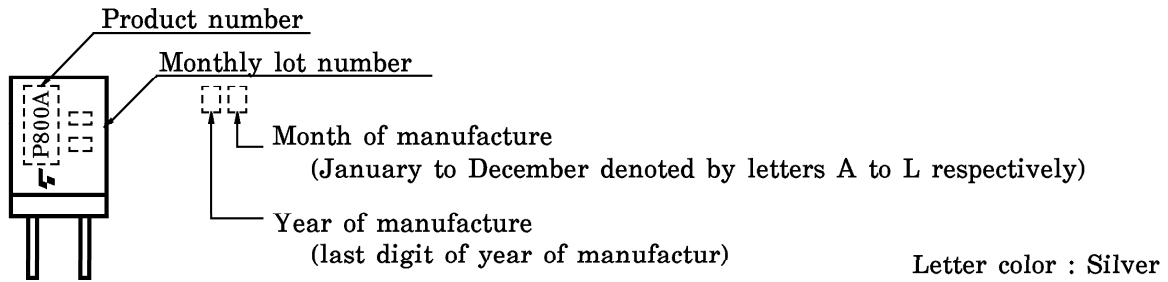

OPTICAL AND ELECTRICAL CHARACTERISTICS (Ta = 25°C)

CHARACTERISTIC		SYMBOL	TEST CONDITION	Min	Typ.	Max	UNIT
LED	Forward Voltage	V_F	$I_F = 10 \text{ mA}$	1.00	1.15	1.30	V
	Reverse Current	I_R	$V_R = 5 \text{ V}$	—	—	10	μA
	Peak Emission Wavelength	λ_P	$I_F = 10 \text{ mA}$	—	940	—	nm
DETECTOR	Dark Current	$I_D (I_{CEO})$	$V_{CE} = 24 \text{ V}, I_F = 0$	—	—	0.1	μA
	Peak Sensitivity Wavelength	λ_P	—	—	820	—	nm
COUPLED	Current Transfer Ratio	I_C / I_F	$V_{CE} = 5 \text{ V}, I_F = 20 \text{ mA}$	10	—	165	%
	Collector-Emitter Saturation Voltage	$V_{CE}(\text{sat})$	$I_F = 20 \text{ mA}, I_C = 1 \text{ mA}$	—	0.15	0.4	V
	Rise Time	t_r	$V_{CC} = 5 \text{ V}, I_C = 2 \text{ mA}, R_L = 100 \Omega$	—	6	—	μs
	Fall Time	t_f		—	6	—	

PRECAUTIONS

The following points must be borne in mind.

- Soldering temperature : 260°C max
Soldering time : 5 s max
(Soldering must be performed 1.5 mm under the package body.)
- Clean only the soldered part of the leads. Do not immerse the entire package in the cleaning solvent.
- Mount the device on a level surface.
- Screws should be tightened to a clamping torque of 0.59 N·m.
- The package is made of polycarbonate. Polycarbonate is usually stable with acid, alcohol and aliphatic hydrocarbons, however, with petrochemicals (such as benzene, toluene and acetone), alkalis, aromatic hydrocarbons, or chloric hydrocarbons, polycarbonate may crack, swell or melt. Please take this into account when choosing a packaging material by referring to the table below.

<Chemicals which should not be used with polycarbonate>

	PHENOMENON	CHEMICALS
A	Staining and slight deterioration	<ul style="list-style-type: none"> Nitric acid (diluted), hydrogen peroxide, chlorine
B	Cracking, crazed or swelling	<ul style="list-style-type: none"> Acetic acid (70% or more) Gasoline Methyl ethyl ketone, ethyl acetate, butyl acetate Ethyl methacrylate, ethyl ether, MEK Acetone, m-amino alcohol, carbon tetrachloride Carbon disulfide, trichloroethylene, cresol Thinners, oil of turpentine Triethanolamine, TCP, TBP
C	Melting { } : Used as solvent	<ul style="list-style-type: none"> Concentrated sulfuric acid Benzene Styrene, acrylonitrile, vinyl acetate Ethylenediamine, diethylenediamine {Chloroform, methyl chloride, tetrachloromethane, dioxane, 1, 2-dichloroethane}
D	Decomposition	<ul style="list-style-type: none"> Ammonia water Other alkalis

- Conversion efficiency falls over time due to the current which flows in the infrared LED. When designing a circuit, take into account this change in conversion efficiency over time. The ratio of fluctuation in conversion efficiency to fluctuation in infrared LED optical output is 1:1.

$$\frac{I_C / I_F(t)}{I_C / I_F(0)} = \frac{P_O(t)}{P_O(0)}$$

PACKAGE DIMENSIONS
11-13D1

Unit : mm

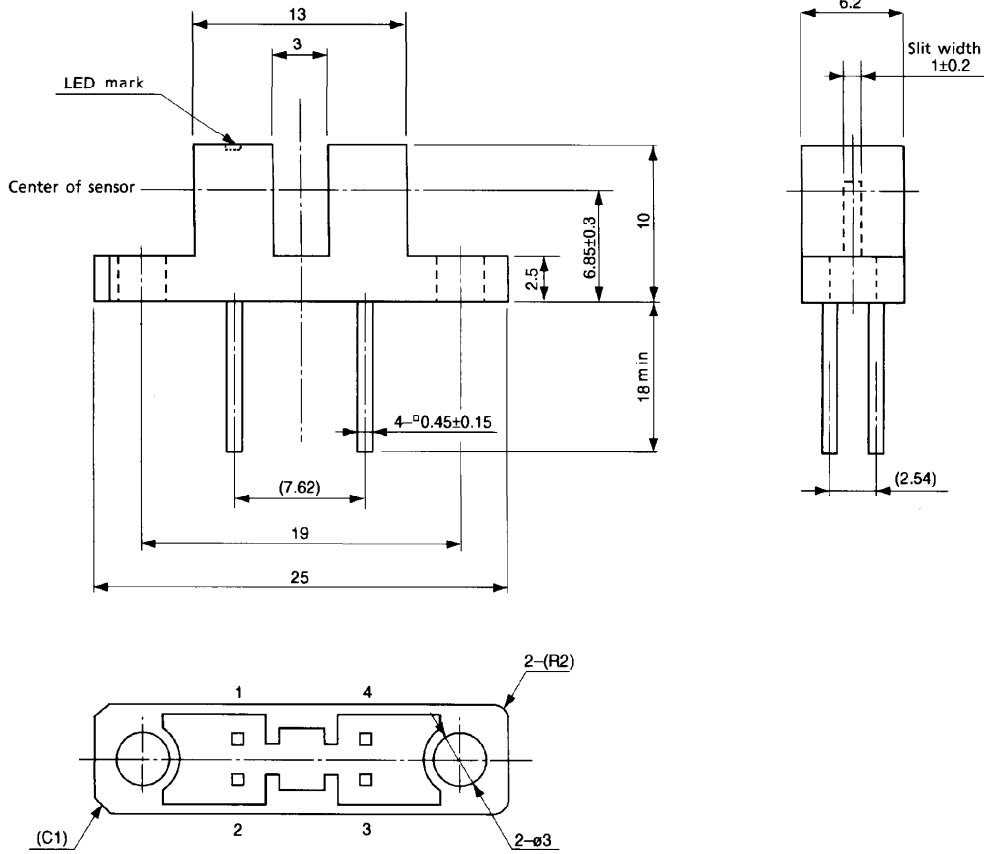

Tolerance unless otherwise specified : ±0.25
() : Reference value

Weight : 0.81 g (typ.)

PIN CONNECTION

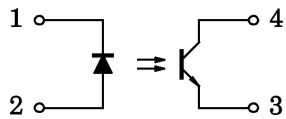

- 1. Cathode
- 2. Anode
- 3. Emitter
- 4. Collector

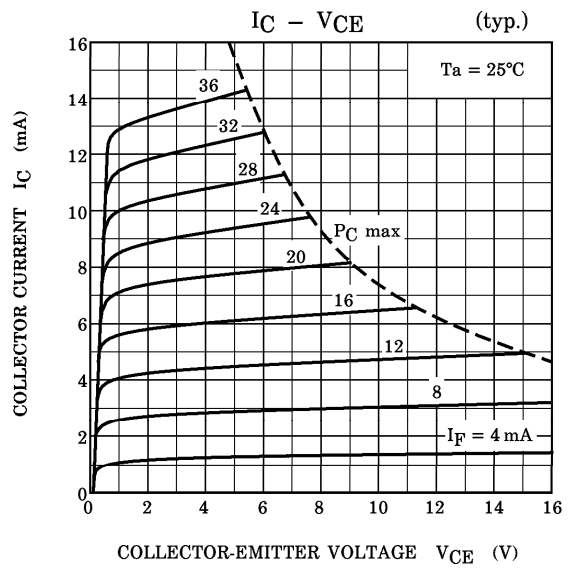
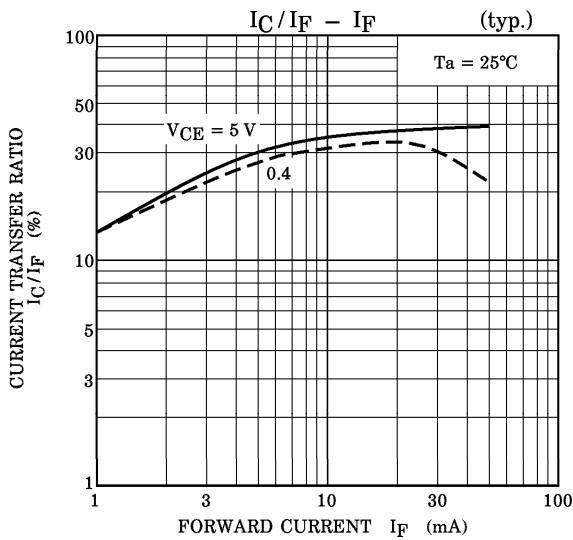
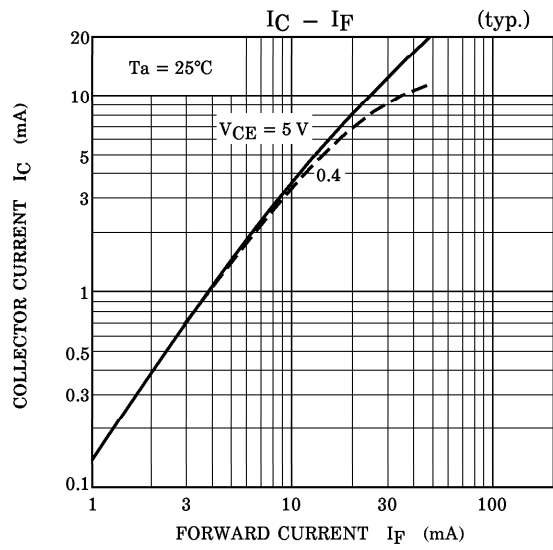
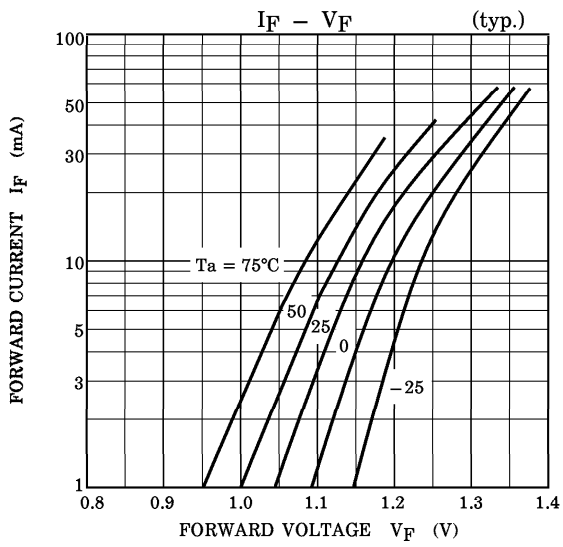
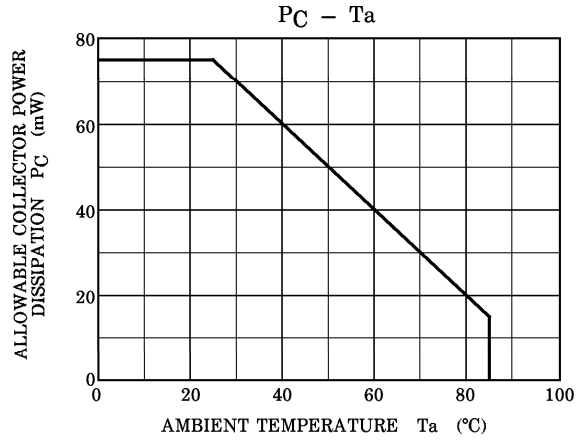
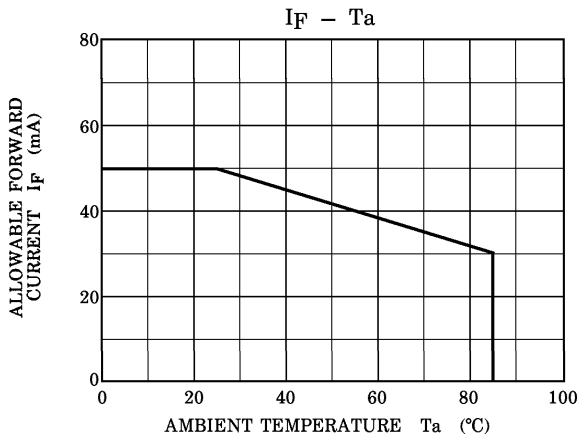

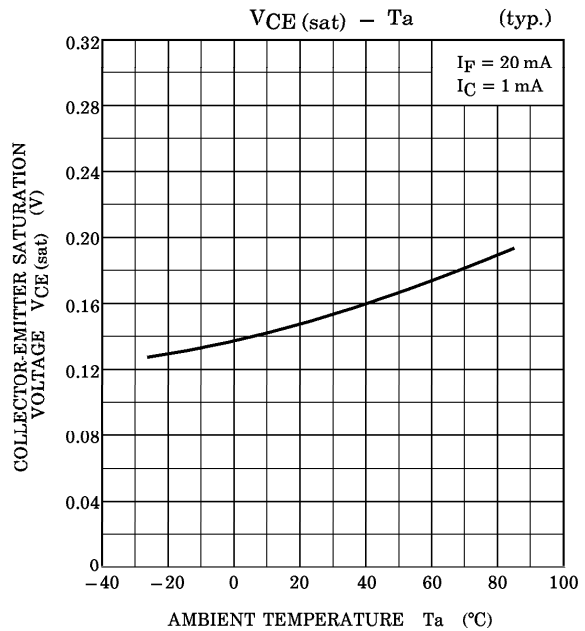
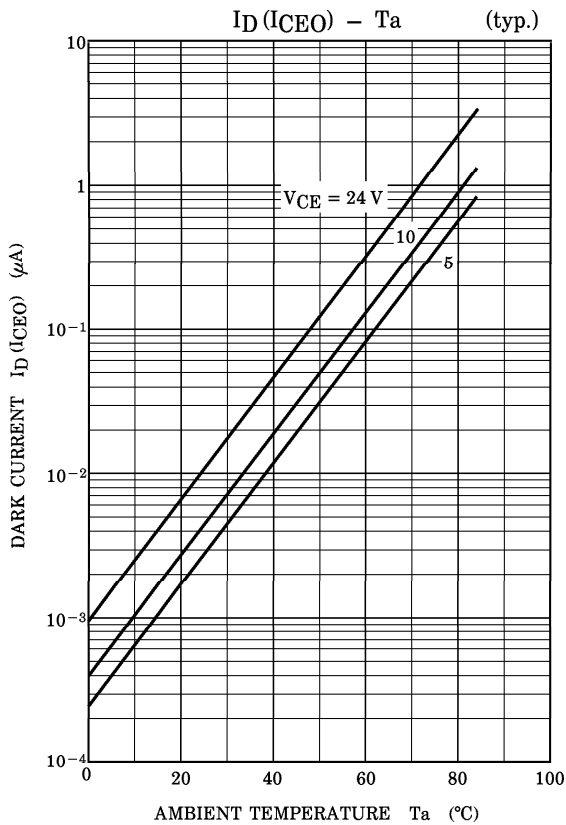
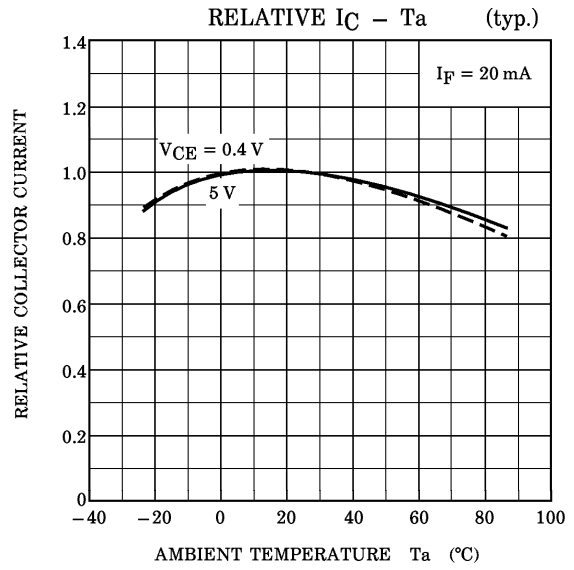
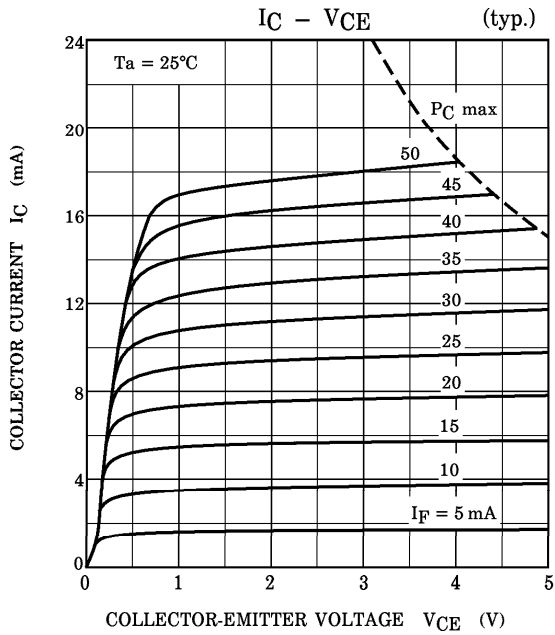

SWITCHING CHARACTERISTICS (NON SATURATED OPERATION) (typ.)

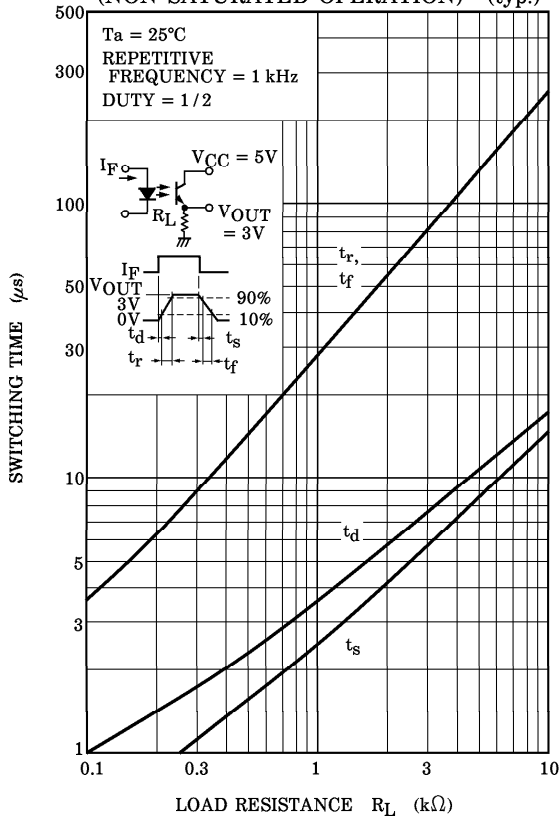

SWITCHING CHARACTERISTICS (SATURATED OPERATION) (typ.)

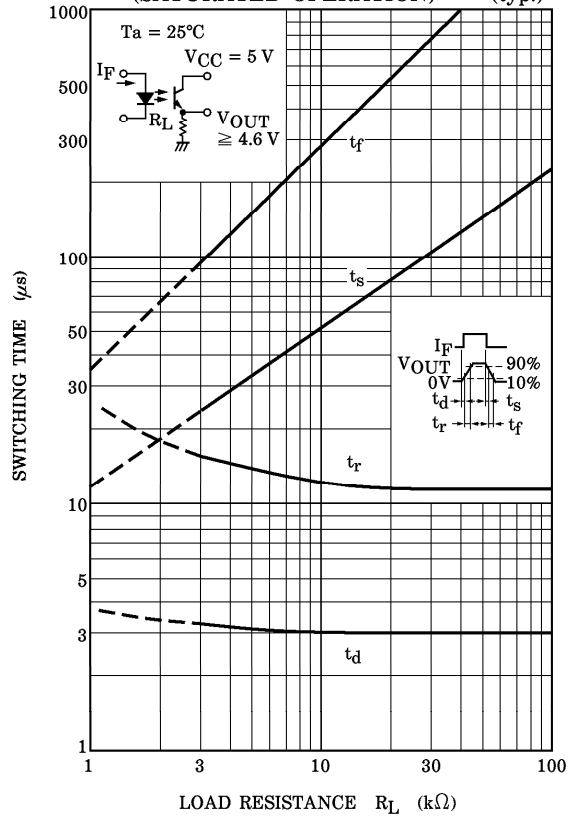

DETECTION POSITION CHARACTERISTICS (1) (typ.)

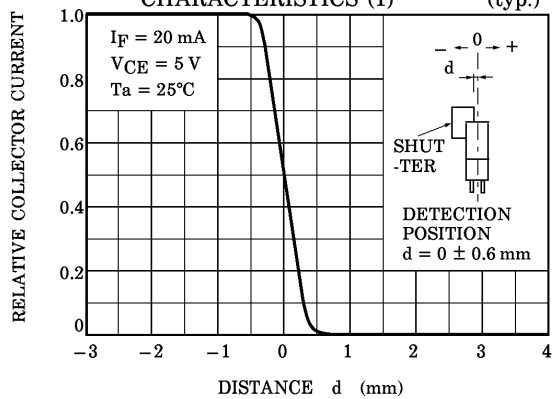

DETECTION POSITION CHARACTERISTICS (2) (typ.)

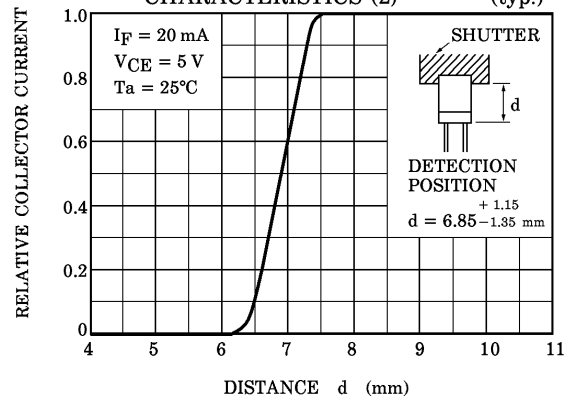

RELATIVE POSITIONING OF SHUTTER AND DEVICE

For normal operation position the shutter and the device as shown in the figure below. By considering the device's detection direction characteristic and switching time, determine the shutter slit width and pitch.

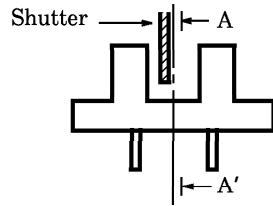

Unit in mm

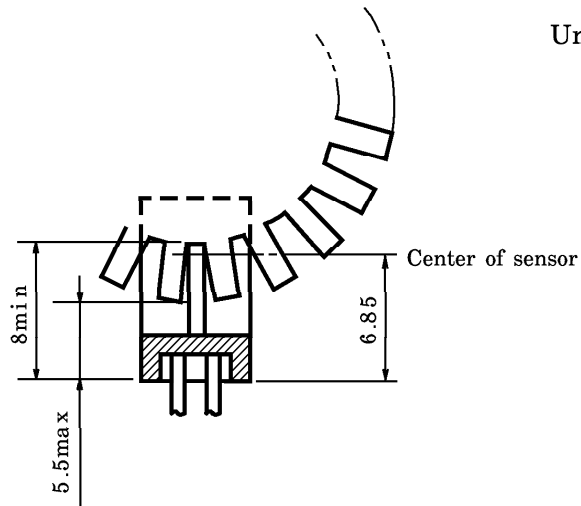

Cross section between A and A'

RESTRICTIONS ON PRODUCT USE

000707EAC

- TOSHIBA is continually working to improve the quality and reliability of its products. Nevertheless, semiconductor devices in general can malfunction or fail due to their inherent electrical sensitivity and vulnerability to physical stress. It is the responsibility of the buyer, when utilizing TOSHIBA products, to comply with the standards of safety in making a safe design for the entire system, and to avoid situations in which a malfunction or failure of such TOSHIBA products could cause loss of human life, bodily injury or damage to property. In developing your designs, please ensure that TOSHIBA products are used within specified operating ranges as set forth in the most recent TOSHIBA products specifications. Also, please keep in mind the precautions and conditions set forth in the "Handling Guide for Semiconductor Devices," or "TOSHIBA Semiconductor Reliability Handbook" etc..
- The TOSHIBA products listed in this document are intended for usage in general electronics applications (computer, personal equipment, office equipment, measuring equipment, industrial robotics, domestic appliances, etc.). These TOSHIBA products are neither intended nor warranted for usage in equipment that requires extraordinarily high quality and/or reliability or a malfunction or failure of which may cause loss of human life or bodily injury ("Unintended Usage"). Unintended Usage include atomic energy control instruments, airplane or spaceship instruments, transportation instruments, traffic signal instruments, combustion control instruments, medical instruments, all types of safety devices, etc.. Unintended Usage of TOSHIBA products listed in this document shall be made at the customer's own risk.
- Gallium arsenide (GaAs) is a substance used in the products described in this document. GaAs dust and fumes are toxic. Do not break, cut or pulverize the product, or use chemicals to dissolve them. When disposing of the products, follow the appropriate regulations. Do not dispose of the products with other industrial waste or with domestic garbage.
- The information contained herein is presented only as a guide for the applications of our products. No responsibility is assumed by TOSHIBA CORPORATION for any infringements of intellectual property or other rights of the third parties which may result from its use. No license is granted by implication or otherwise under any intellectual property or other rights of TOSHIBA CORPORATION or others.
- The information contained herein is subject to change without notice.