

TOSHIBA PHOTO-INTERRUPTER INFRARED LED + PHOTOTRANSISTOR

TLP810

MOTOR ROTATION AND IRIS DETECTION FOR CAMERAS

TRACK DETECTION IN MICRO FLOPPY DISK DRIVE

- Very small package
- High resolution : Slit width = 0.4 mm
- Gap : 1 mm
- Can be mounted directly on PCB using the stand off of lead.

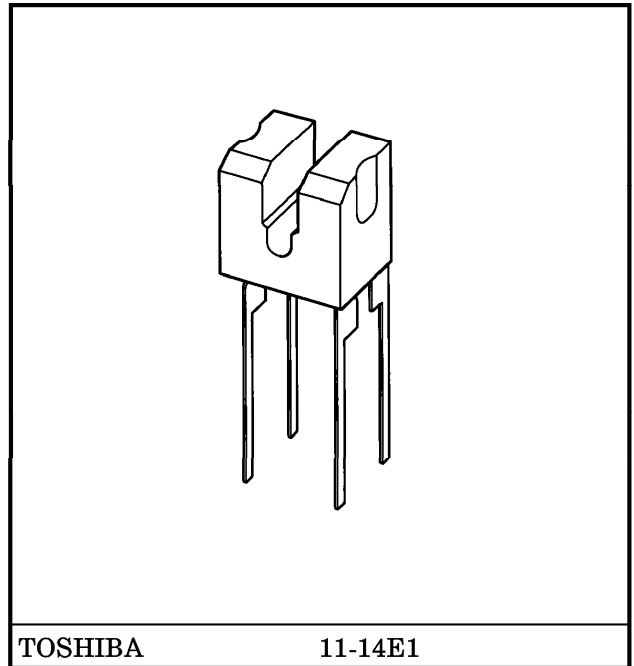

TOSHIBA

11-14E1

Weight : 0.07 g (typ.)

MAXIMUM RATINGS (Ta = 25°C)

CHARACTERISTIC		SYMBOL	RATING	UNIT
LED	Forward Current	I_F	50	mA
	Forward Current Derating (Ta > 25°C)	$I_F / ^\circ\text{C}$	-0.67	mA / °C
	Reverse Voltage	V_R	5	V
DETECTOR	Collector-Emitter Voltage	V_{CEO}	35	V
	Emitter Collector Voltage	V_{ECO}	5	V
	Collector Current	I_C	20	mA
	Collector Power Dissipation	P_C	75	mW
	Collector Power Dissipation (Ta > 25°C)	$\Delta P_C / ^\circ\text{C}$	-1	mW / °C
Operating Temperature Range		T_{opr}	-25~85	°C
Storage Temperature Range		T_{stg}	-40~100	°C

OPTICAL AND ELECTRICAL CHARACTERISTICS (Ta = 25°C)

CHARACTERISTIC		SYMBOL	TEST CONDITION	Min	Typ.	Max	UNIT
LED	Forward Voltage	V _F	I _F = 10 mA	1.00	1.15	1.30	V
	Reverse Current	I _R	V _R = 5 V	—	—	10	μA
	Capacitance	C _T	V = 0, f = 1 MHz	—	30	—	pF
DETECTOR	Dark Current	I _D (I _{CEO})	V _{CE} = 20 V, I _F = 0	—	—	100	nA
	Capacitance	C _T	V = 0, f = 1 MHz	—	13	—	pF
COUPLED	Current Transfer Ratio	I _C / I _F	V _{CE} = 0.6 V, I _F = 5 mA	5	—	30	%
	Collector-Emitter Saturation Voltage	V _{CE} (sat)	I _F = 8 mA, I _C = 0.1 mA	—	0.1	0.4	V
	Rise Time	t _r	V _{CC} = 5 V, I _C = 0.2 mA, R _L = 1 kΩ	—	50	—	μs
	Fall Time	t _f		—	50	—	

PRECAUTIONS

The following points must be borne in mind.

- Soldering temperature : 260°C max
Soldering time : 5 s max
(Soldering must be performed 1.5 mm under the stopper.)
- Ensure that no residual flux or chemicals adhere to the light-emitting and light-receiving surfaces.

ENVIRONMENT

- The device should not be exposed to corrosive gases, such as hydrogen sulfide gas and a sea breeze.
- The device should not be exposed to dust.
- The device should not be exposed to direct sunlight.
In essence, the device should not be subjected to any load which may result in deformation or performance deterioration.

CIRCUIT DESIGN

- Conversion efficiency falls over time due to the current which flows in the infrared LED.
When designing a circuit, take into account this change in conversion efficiency over time.
The ratio of fluctuation in conversion efficiency to fluctuation in infrared LED optical output is 1 : 1.

$$\frac{I_C / I_F (t)}{I_C / I_F (0)} = \frac{P_O (t)}{P_O (0)}$$

PACKAGE DIMENSIONS
11-14E1

Unit : mm

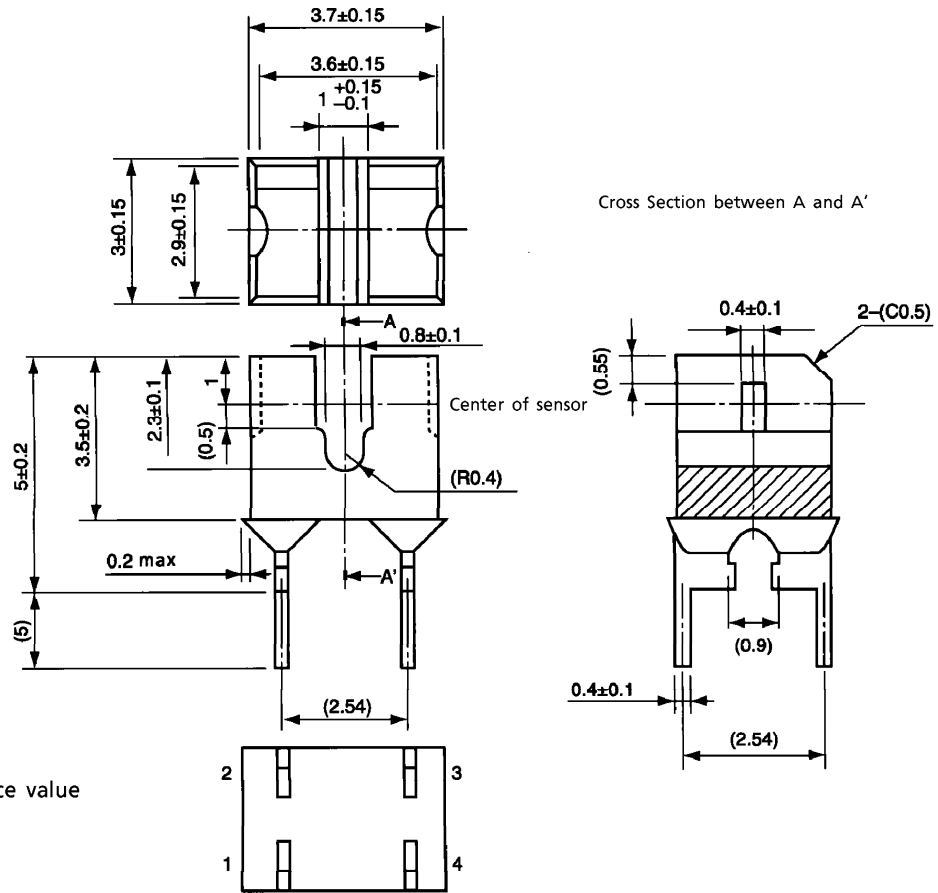

Weight : 0.07 g (typ.)

PIN CONNECTION

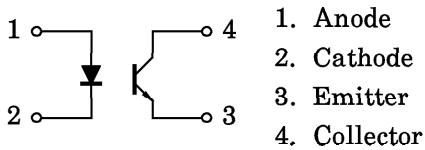

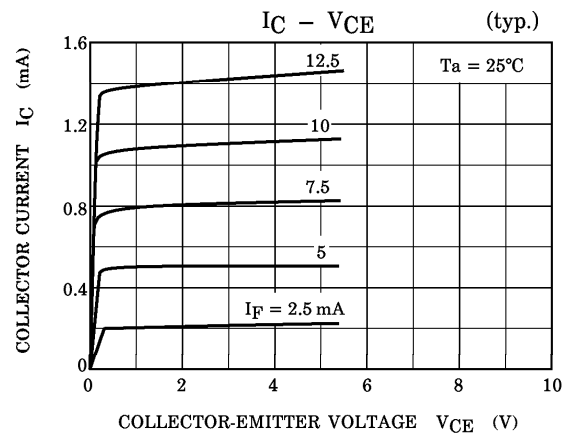
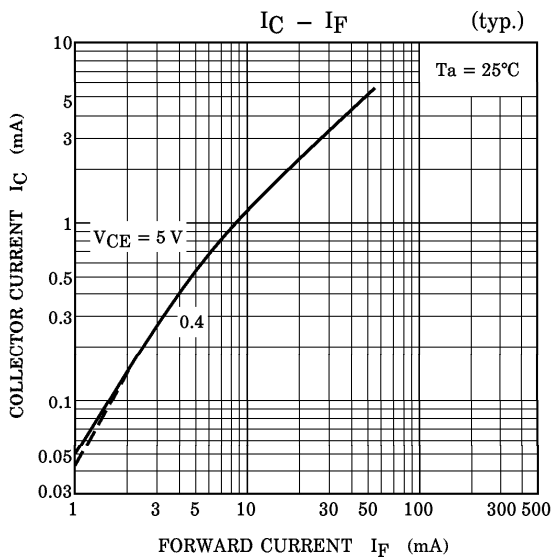
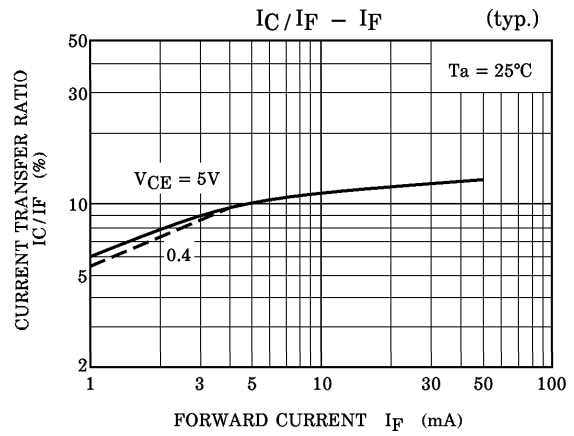
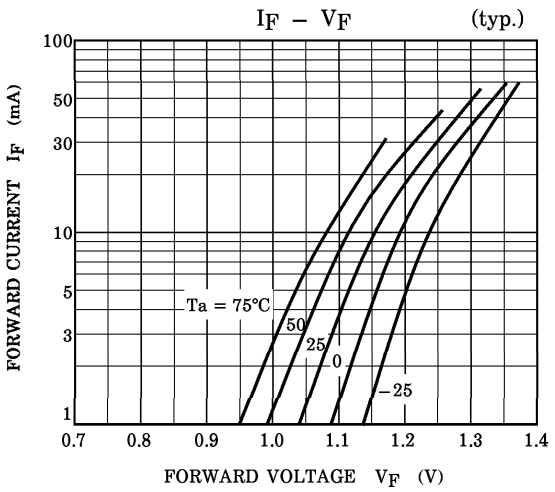
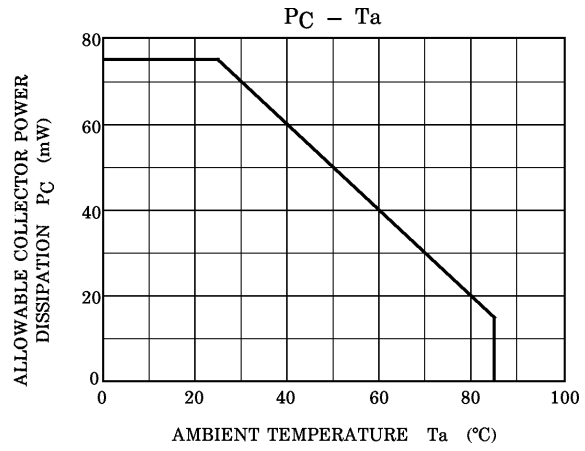
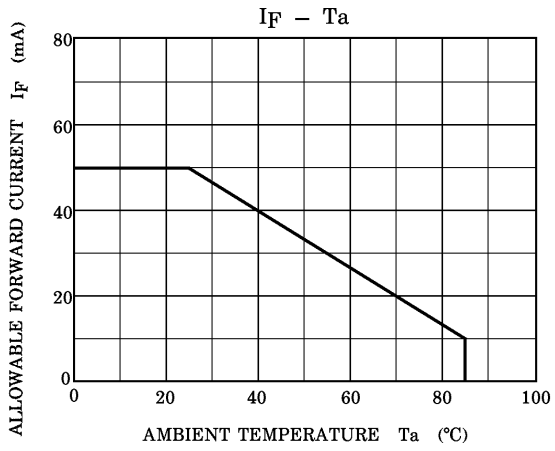

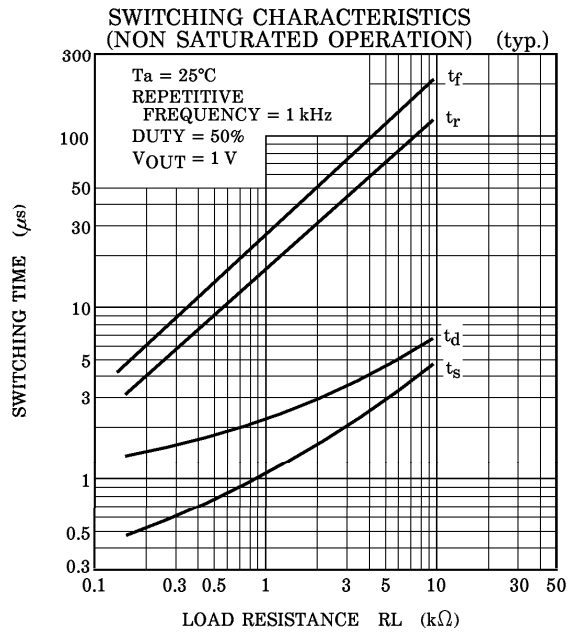
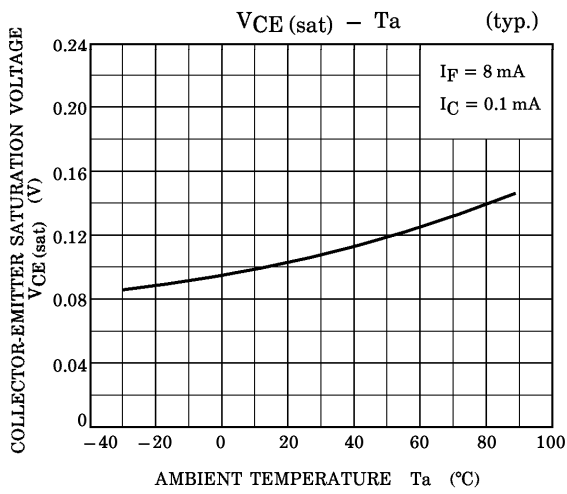
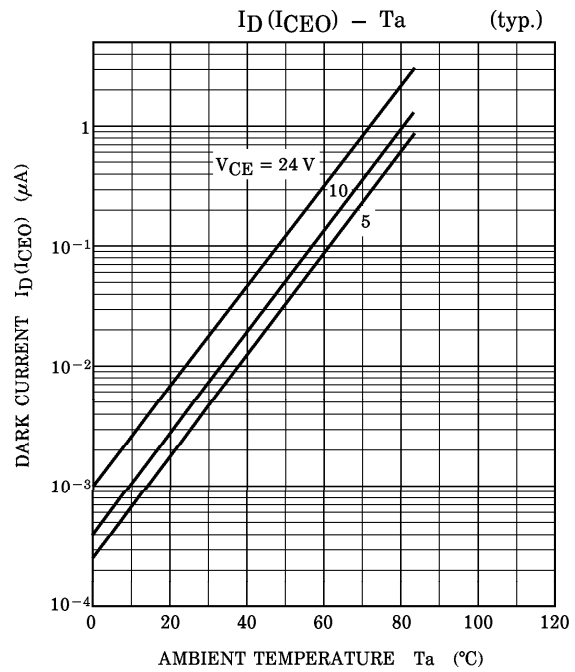
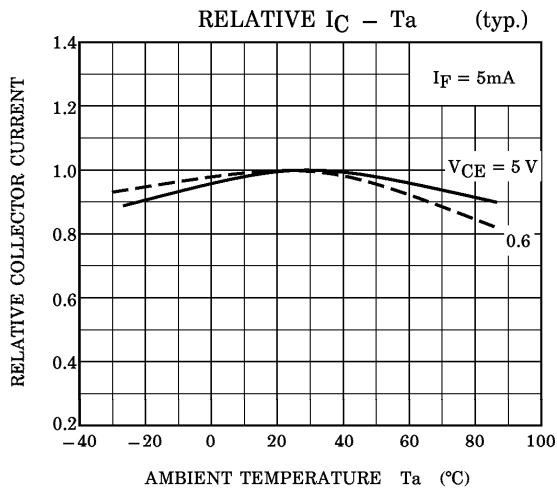

SWITCHING CHARACTERISTICS (SATURATED OPERATION) (typ.)

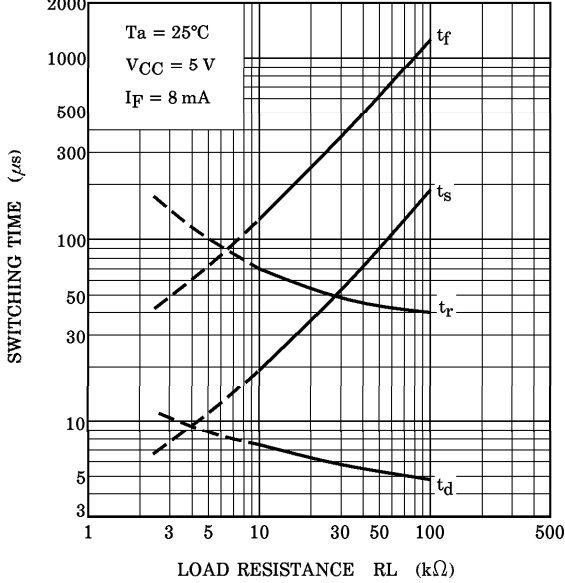

DETECTION POSITION CHARACTERISTICS (1) (typ.)

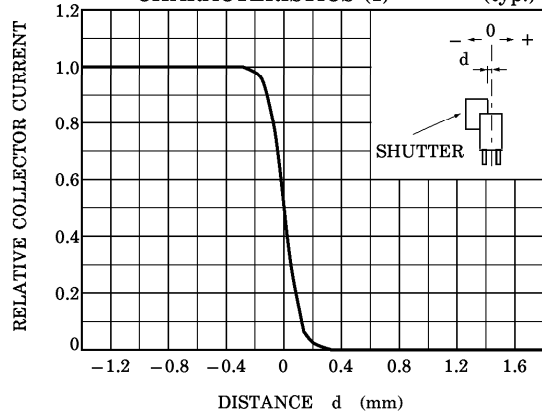

DETECTION POSITION CHARACTERISTICS (2) (typ.)

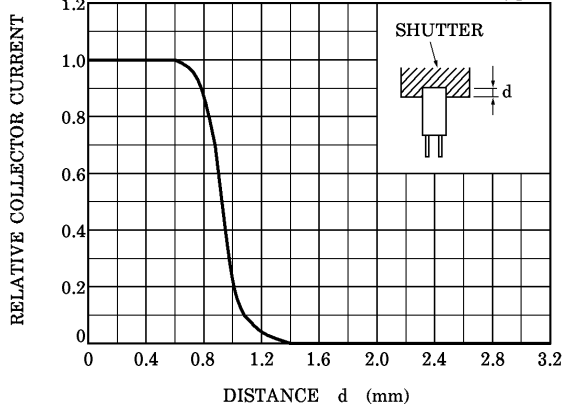

SWITCHING TIME TEST CIRCUIT

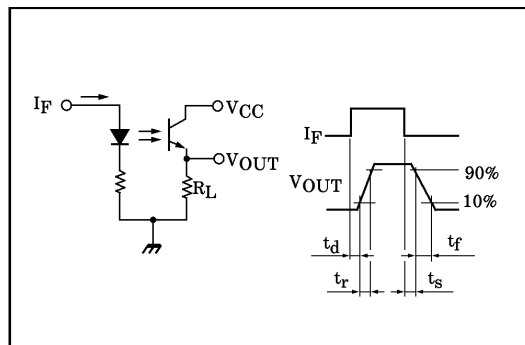

RESTRICTIONS ON PRODUCT USE

000707EAC

- TOSHIBA is continually working to improve the quality and reliability of its products. Nevertheless, semiconductor devices in general can malfunction or fail due to their inherent electrical sensitivity and vulnerability to physical stress. It is the responsibility of the buyer, when utilizing TOSHIBA products, to comply with the standards of safety in making a safe design for the entire system, and to avoid situations in which a malfunction or failure of such TOSHIBA products could cause loss of human life, bodily injury or damage to property. In developing your designs, please ensure that TOSHIBA products are used within specified operating ranges as set forth in the most recent TOSHIBA products specifications. Also, please keep in mind the precautions and conditions set forth in the "Handling Guide for Semiconductor Devices," or "TOSHIBA Semiconductor Reliability Handbook" etc..
- The TOSHIBA products listed in this document are intended for usage in general electronics applications (computer, personal equipment, office equipment, measuring equipment, industrial robotics, domestic appliances, etc.). These TOSHIBA products are neither intended nor warranted for usage in equipment that requires extraordinarily high quality and/or reliability or a malfunction or failure of which may cause loss of human life or bodily injury ("Unintended Usage"). Unintended Usage include atomic energy control instruments, airplane or spaceship instruments, transportation instruments, traffic signal instruments, combustion control instruments, medical instruments, all types of safety devices, etc.. Unintended Usage of TOSHIBA products listed in this document shall be made at the customer's own risk.
- Gallium arsenide (GaAs) is a substance used in the products described in this document. GaAs dust and fumes are toxic. Do not break, cut or pulverize the product, or use chemicals to dissolve them. When disposing of the products, follow the appropriate regulations. Do not dispose of the products with other industrial waste or with domestic garbage.
- The information contained herein is presented only as a guide for the applications of our products. No responsibility is assumed by TOSHIBA CORPORATION for any infringements of intellectual property or other rights of the third parties which may result from its use. No license is granted by implication or otherwise under any intellectual property or other rights of TOSHIBA CORPORATION or others.
- The information contained herein is subject to change without notice.