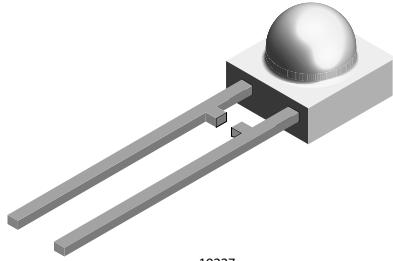




Side View LED, Ø 5 mm Tinted Diffused Package



19227

FEATURES

- Even luminance of the emitting surface
- Wide viewing angle
- Yellow and green color categorized
- For DC and pulse operation
- Material categorization:
for definitions of compliance please see www.vishay.com/doc?99912



PRODUCT GROUP AND PACKAGE DATA

- Product group: LED
- Package: 5 mm side view
- Product series: standard
- Angle of half intensity: $\pm 80^\circ$

APPLICATIONS

- Indicating and illumination purposes

PARTS TABLE														
PART	COLOR	LUMINOUS INTENSITY (mcd)			at I _F (mA)	WAVELENGTH (nm)			at I _F (mA)	FORWARD VOLTAGE (V)			at I _F (mA)	TECHNOLOGY
		MIN.	TYP.	MAX.		MIN.	TYP.	MAX.		MIN.	TYP.	MAX.		
TLPR5600	Super red	1	3.5	-	10	-	630	-	10	-	2	3	20	GaAsP on GaP
TLPH5600	Red	0.63	3.5	-	10	612	-	625	10	-	2	3	20	GaAsP on GaP
TLPY5600	Yellow	0.63	2.25	-	10	581	-	594	10	-	2.4	3	20	GaAsP on GaP
TLPG5600	Green	0.63	2.25	-	10	562	-	575	10	-	2.4	3	20	GaP on GaP

ABSOLUTE MAXIMUM RATINGS (T _{amb} = 25 °C, unless otherwise specified) TLPR5600, TLPH5600, TLPY5600, TLPG5600					
PARAMETER	TEST CONDITION	PART	SYMBOL	VALUE	UNIT
Reverse voltage			V _R	6	V
DC forward current		TLPR5600	I _F	20	mA
		TLPH5600	I _F	30	mA
		TLPY5600	I _F	30	mA
		TLPG5600	I _F	30	mA
Surge forward current	t _p ≤ 10 μs		I _{FSM}	1	A
Power dissipation	T _{amb} ≤ 60 °C	TLPR5600	P _V	60	mW
		TLPH5600	P _V	100	mW
		TLPY5600	P _V	100	mW
		TLPG5600	P _V	100	mW
Junction temperature			T _j	100	°C
Operating temperature range			T _{amb}	-40 to +100	°C
Storage temperature range			T _{stg}	-55 to +100	°C
Soldering temperature	t ≤ 5 s, 2 mm from body		T _{sd}	260	°C
Thermal resistance junction to ambient		TLPR5600	R _{thJA}	500	K/W
		TLPH5600	R _{thJA}	400	K/W
		TLPY5600	R _{thJA}	400	K/W
		TLPG5600	R _{thJA}	400	K/W

**OPTICAL AND ELECTRICAL CHARACTERISTICS** ($T_{amb} = 25\text{ }^{\circ}\text{C}$, unless otherwise specified)
TLPR5600, SUPER RED

PARAMETER	TEST CONDITION	SYMBOL	MIN.	TYP.	MAX.	UNIT
Luminous intensity ⁽¹⁾	$I_F = 10\text{ mA}$	I_V	1	3.5	-	mcd
Dominant wavelength	$I_F = 10\text{ mA}$	λ_d	-	630	-	nm
Peak wavelength	$I_F = 10\text{ mA}$	λ_p	-	640	-	nm
Angle of half intensity	$I_F = 10\text{ mA}$	φ	-	± 80	-	$^{\circ}$
Forward voltage	$I_F = 20\text{ mA}$	V_F	-	2	3	V
Reverse voltage	$I_R = 10\text{ }\mu\text{A}$	V_R	6	15	-	V
Junction capacitance	$V_R = 0\text{ V}$, $f = 1\text{ MHz}$	C_j	-	50	-	pF

Note⁽¹⁾ In one packing unit $I_{Vmin}/I_{Vmax} \leq 0.5$ **OPTICAL AND ELECTRICAL CHARACTERISTICS** ($T_{amb} = 25\text{ }^{\circ}\text{C}$, unless otherwise specified)
TLPH5600, RED

PARAMETER	TEST CONDITION	SYMBOL	MIN.	TYP.	MAX.	UNIT
Luminous intensity ⁽¹⁾	$I_F = 10\text{ mA}$	I_V	0.63	3.5	-	mcd
Dominant wavelength	$I_F = 10\text{ mA}$	λ_d	612	-	625	nm
Peak wavelength	$I_F = 10\text{ mA}$	λ_p	-	635	-	nm
Angle of half intensity	$I_F = 10\text{ mA}$	φ	-	± 80	-	$^{\circ}$
Forward voltage	$I_F = 20\text{ mA}$	V_F	-	2	3	V
Reverse voltage	$I_R = 10\text{ }\mu\text{A}$	V_R	6	15	-	V
Junction capacitance	$V_R = 0\text{ V}$, $f = 1\text{ MHz}$	C_j	-	50	-	pF

Note⁽¹⁾ In one packing unit $I_{Vmin}/I_{Vmax} \leq 0.5$ **OPTICAL AND ELECTRICAL CHARACTERISTICS** ($T_{amb} = 25\text{ }^{\circ}\text{C}$, unless otherwise specified)
TLPY5600, YELLOW

PARAMETER	TEST CONDITION	SYMBOL	MIN.	TYP.	MAX.	UNIT
Luminous intensity ⁽¹⁾	$I_F = 10\text{ mA}$	I_V	0.63	2.25	-	mcd
Dominant wavelength	$I_F = 10\text{ mA}$	λ_d	581	-	594	nm
Peak wavelength	$I_F = 10\text{ mA}$	λ_p	-	585	-	nm
Angle of half intensity	$I_F = 10\text{ mA}$	φ	-	± 80	-	$^{\circ}$
Forward voltage	$I_F = 20\text{ mA}$	V_F	-	2.4	3	V
Reverse voltage	$I_R = 10\text{ }\mu\text{A}$	V_R	6	15	-	V
Junction capacitance	$V_R = 0\text{ V}$, $f = 1\text{ MHz}$	C_j	-	50	-	pF

Note⁽¹⁾ In one packing unit $I_{Vmin}/I_{Vmax} \leq 0.5$ **OPTICAL AND ELECTRICAL CHARACTERISTICS** ($T_{amb} = 25\text{ }^{\circ}\text{C}$, unless otherwise specified)
TLPG5600, GREEN

PARAMETER	TEST CONDITION	SYMBOL	MIN.	TYP.	MAX.	UNIT
Luminous intensity ⁽¹⁾	$I_F = 10\text{ mA}$	I_V	0.63	2.25	-	mcd
Dominant wavelength	$I_F = 10\text{ mA}$	λ_d	562	-	575	nm
Peak wavelength	$I_F = 10\text{ mA}$	λ_p	-	565	-	nm
Angle of half intensity	$I_F = 10\text{ mA}$	φ	-	± 80	-	$^{\circ}$
Forward voltage	$I_F = 20\text{ mA}$	V_F	-	2.4	3	V
Reverse voltage	$I_R = 10\text{ }\mu\text{A}$	V_R	6	15	-	V
Junction capacitance	$V_R = 0\text{ V}$, $f = 1\text{ MHz}$	C_j	-	50	-	pF

Note⁽¹⁾ In one packing unit $I_{Vmin}/I_{Vmax} \leq 0.5$

LUMINOUS INTENSITY CLASSIFICATION		
GROUP	LIGHT INTENSITY (mcd)	
STANDARD	MIN.	MAX.
K	0.63	1.25
L	1	2
M	1.6	3.2
N	2.5	5
P	4	8
Q	6.3	12.5
R	10	20
S	16	32
T	25	50
U	40	80

COLOR CLASSIFICATION				
GROUP	DOM. WAVELENGTH (nm)			
	YELLOW		GREEN	
	MIN.	MAX.	MIN.	MAX.
1	581	584	-	-
2	583	586	-	-
3	585	588	562	565
4	587	590	564	567
5	589	592	566	569
6	591	594	568	571
7	-	-	570	573
8	-	-	572	575

Note

- Wavelengths are tested at a current pulse duration of 25 ms

Note

- Luminous intensity is tested at a current pulse duration of 25 ms. These type numbers represent the order groups which include only a few brightness groups. Only one group will be shipped on each bag (there will be no mixing of two groups on each bag). In order to ensure availability, single brightness groups will not be orderable. In a similar manner for colors where wavelength groups are measured and binned, single wavelength groups will be shipped on any one bag. In order to ensure availability, single wavelength groups will not be orderable

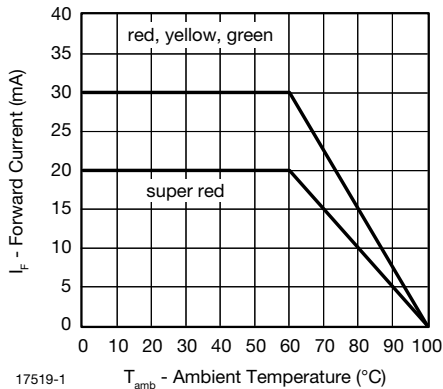
TYPICAL CHARACTERISTICS ($T_{amb} = 25\text{ }^{\circ}\text{C}$, unless otherwise specified)


Fig. 1 - Forward Current vs. Ambient Temperature

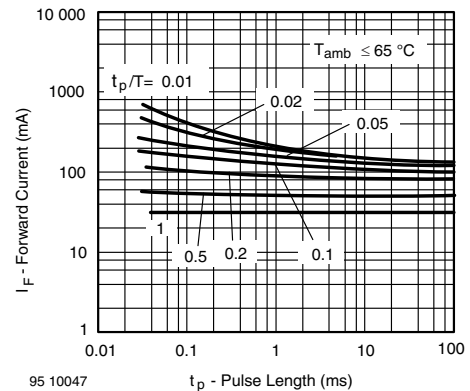


Fig. 2 - Forward Current vs. Pulse Length

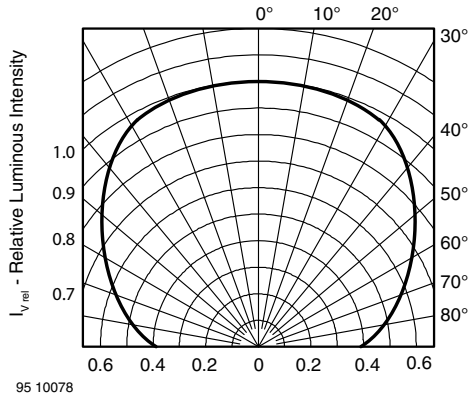


Fig. 3 - Relative Luminous Intensity vs. Angular Displacement

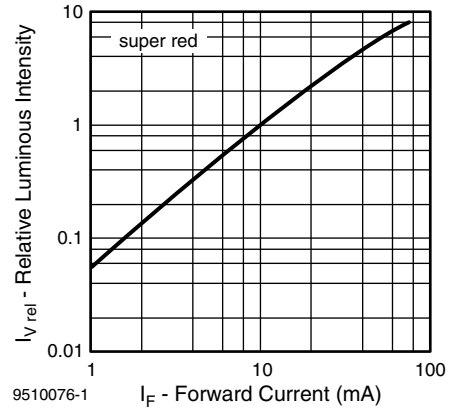


Fig. 6 - Relative Luminous Intensity vs. Forward Current

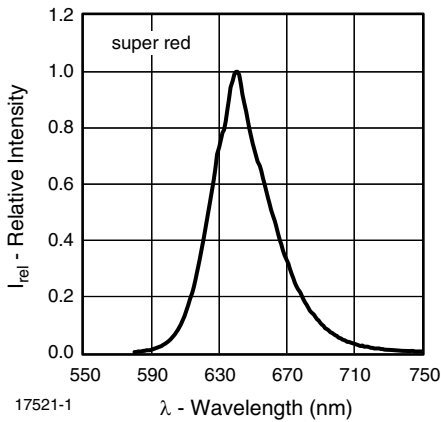


Fig. 4 - Relative Intensity vs. Wavelength

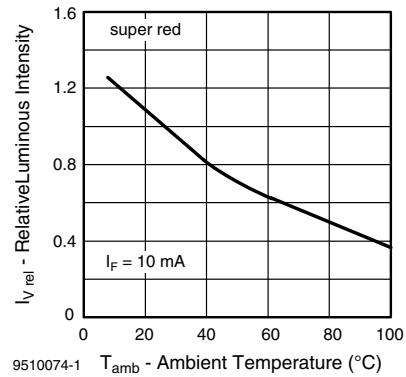


Fig. 7 - Relative Luminous Intensity vs. Ambient Temperature

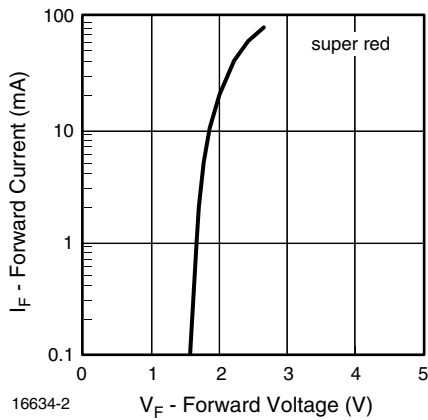


Fig. 5 - Forward Current vs. Forward Voltage

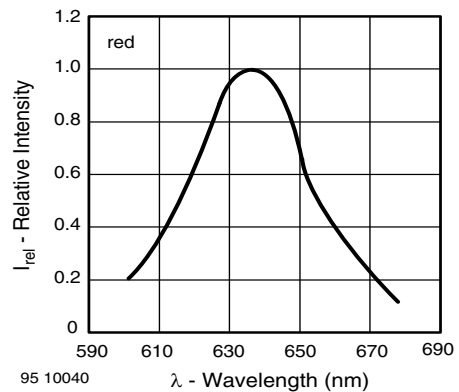


Fig. 8 - Relative Intensity vs. Wavelength

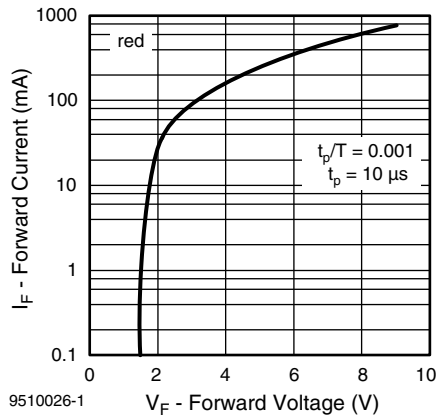


Fig. 9 - Forward Current vs. Forward Voltage

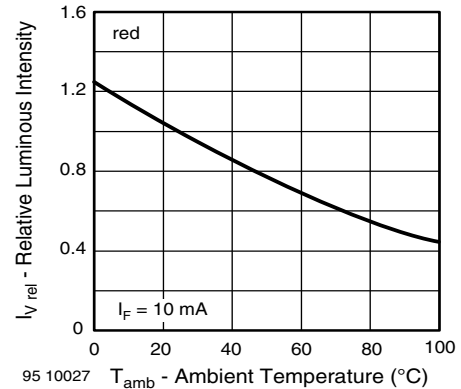


Fig. 12 - Relative Luminous Intensity vs. Ambient Temperature

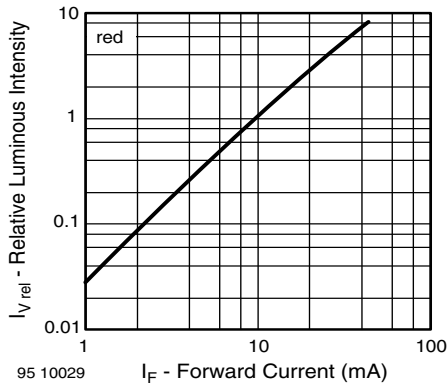


Fig. 10 - Relative Luminous Intensity vs. Forward Current

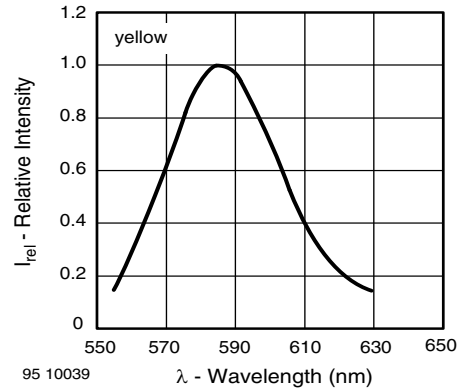


Fig. 13 - Relative Intensity vs. Wavelength

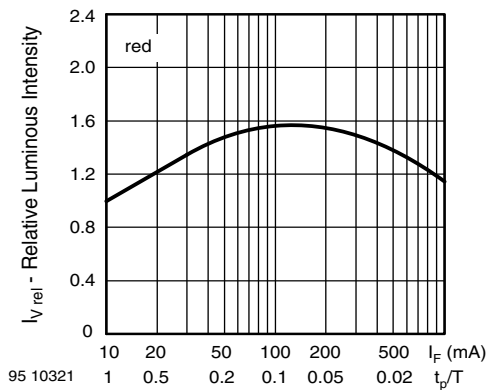


Fig. 11 - Relative Luminous Intensity vs. Forward Current / Duty Cycle

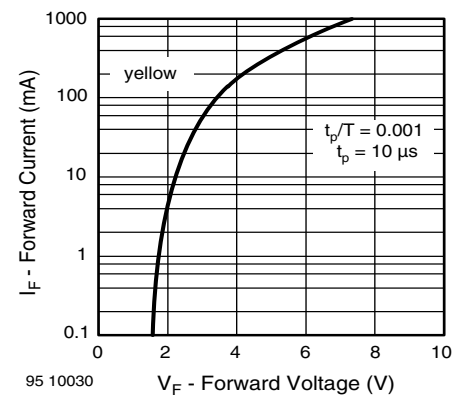


Fig. 14 - Forward Current vs. Forward Voltage

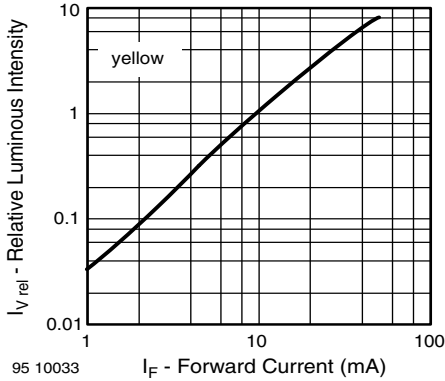


Fig. 15 - Relative Luminous Intensity vs. Forward Current

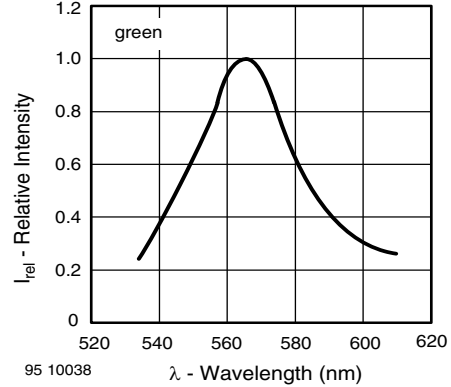


Fig. 18 - Relative Intensity vs. Wavelength

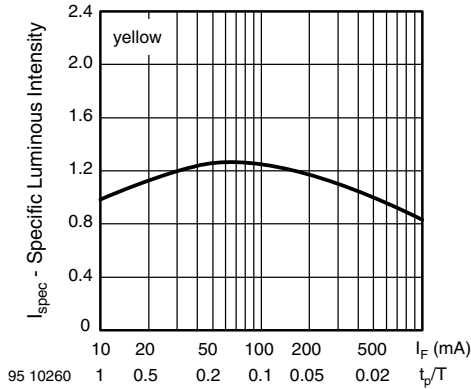


Fig. 16 - Relative Luminous Intensity vs. Forward Current / Duty Cycle

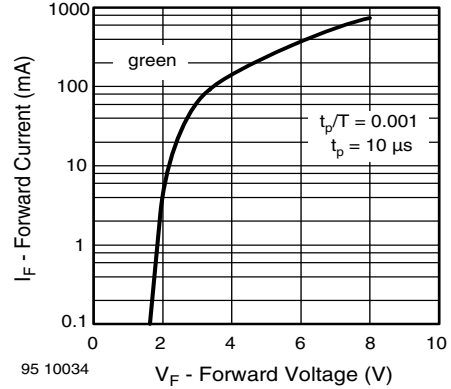


Fig. 19 - Forward Current vs. Forward Voltage

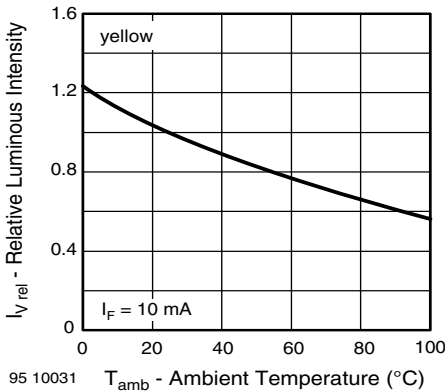


Fig. 17 - Relative Luminous Intensity vs. Ambient Temperature

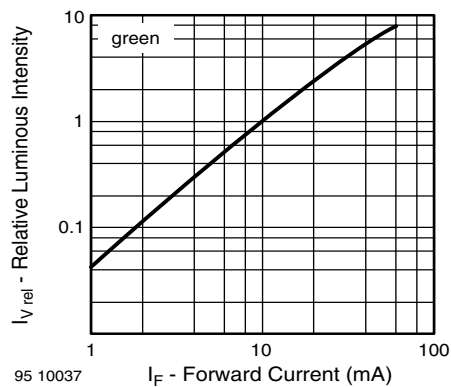


Fig. 20 - Relative Luminous Intensity vs. Forward Current

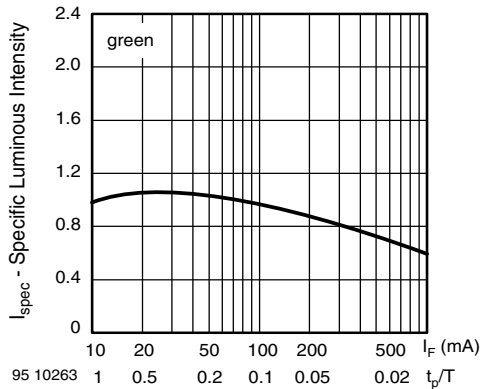


Fig. 21 - Specific Luminous Intensity vs. Forward Current

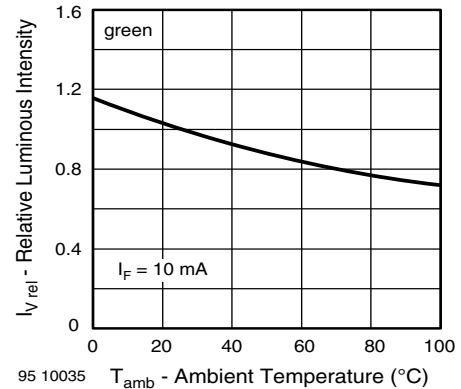
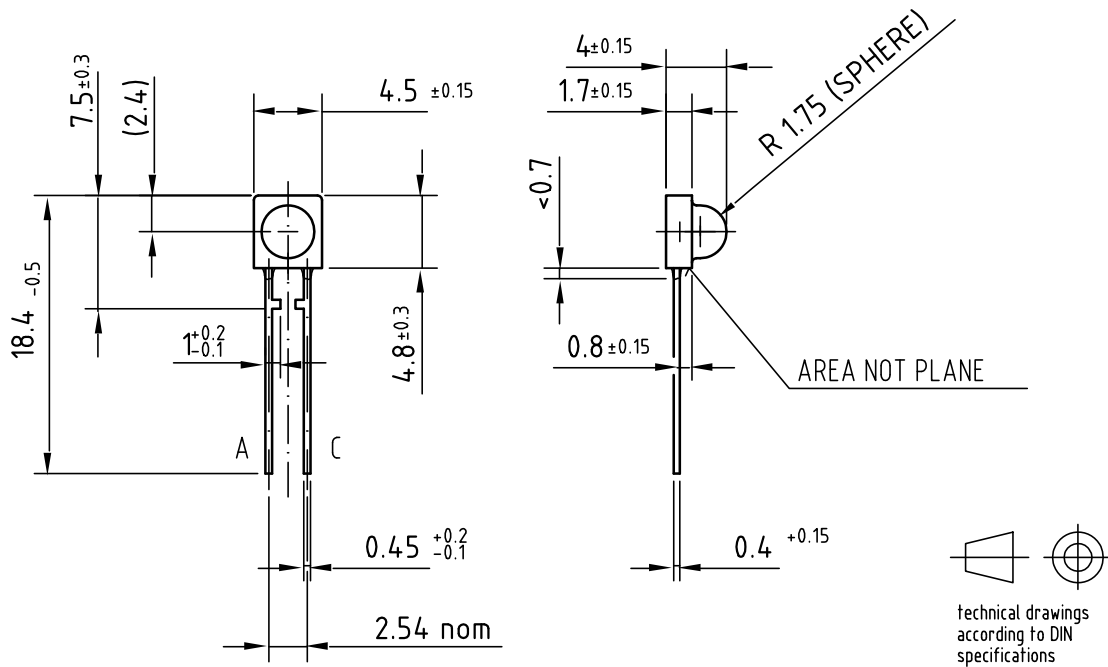


Fig. 22 - Relative Luminous Intensity vs. Ambient Temperature

PACKAGE DIMENSIONS in millimeters



Drawing-No.: 6.544-5127.01-4

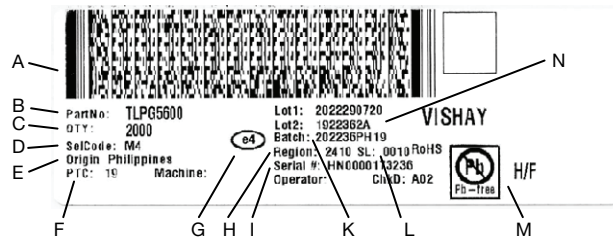
Issue: 1; 15.11.95

95 11321

PACKING INFORMATION	
PART	BULK
TLPx5600	2000



BAR CODE PRODUCT LABEL (example)



- A. 2D barcode
- B. Part No: Vishay part number
- C. QTY: quantity
- D. SelCode: selection bin code
- E. Country of origin
- F. PTC: production plant code
- G. Termination finish
- H. Region code
- I. Serial#: serial number
- J. Batch number: year, week, country code, plant code
- K. SL: storage location
- L. Environmental symbols: RoHS, lead (Pb)-free, halogen-free
- M. Lot numbers



Disclaimer

ALL PRODUCT, PRODUCT SPECIFICATIONS AND DATA ARE SUBJECT TO CHANGE WITHOUT NOTICE TO IMPROVE RELIABILITY, FUNCTION OR DESIGN OR OTHERWISE.

Vishay Intertechnology, Inc., its affiliates, agents, and employees, and all persons acting on its or their behalf (collectively, "Vishay"), disclaim any and all liability for any errors, inaccuracies or incompleteness contained in any datasheet or in any other disclosure relating to any product.

Vishay makes no warranty, representation or guarantee regarding the suitability of the products for any particular purpose or the continuing production of any product. To the maximum extent permitted by applicable law, Vishay disclaims (i) any and all liability arising out of the application or use of any product, (ii) any and all liability, including without limitation special, consequential or incidental damages, and (iii) any and all implied warranties, including warranties of fitness for particular purpose, non-infringement and merchantability.

Statements regarding the suitability of products for certain types of applications are based on Vishay's knowledge of typical requirements that are often placed on Vishay products in generic applications. Such statements are not binding statements about the suitability of products for a particular application. It is the customer's responsibility to validate that a particular product with the properties described in the product specification is suitable for use in a particular application. Parameters provided in datasheets and / or specifications may vary in different applications and performance may vary over time. All operating parameters, including typical parameters, must be validated for each customer application by the customer's technical experts. Product specifications do not expand or otherwise modify Vishay's terms and conditions of purchase, including but not limited to the warranty expressed therein.

Hyperlinks included in this datasheet may direct users to third-party websites. These links are provided as a convenience and for informational purposes only. Inclusion of these hyperlinks does not constitute an endorsement or an approval by Vishay of any of the products, services or opinions of the corporation, organization or individual associated with the third-party website. Vishay disclaims any and all liability and bears no responsibility for the accuracy, legality or content of the third-party website or for that of subsequent links.

Except as expressly indicated in writing, Vishay products are not designed for use in medical, life-saving, or life-sustaining applications or for any other application in which the failure of the Vishay product could result in personal injury or death. Customers using or selling Vishay products not expressly indicated for use in such applications do so at their own risk. Please contact authorized Vishay personnel to obtain written terms and conditions regarding products designed for such applications.

No license, express or implied, by estoppel or otherwise, to any intellectual property rights is granted by this document or by any conduct of Vishay. Product names and markings noted herein may be trademarks of their respective owners.