

## TOSHIBA LED LAMP

**TLG336S, TLG337S, TLS336S  
TLS337S, TLR336S, TLR337S**

- 8.0mm (0.3") Character Height Numerical Display.
- Application : Numerical Readout for Instrument and Consumer Product.
- Luminous Intensity Ranking Performed Uniform Display.
- Available Both Type of Package Colors.  
TL□xxxS : Gray Color Coated Only on Surface.  
TL□xxxT : Black Color Coated Only on Surface.

## PRODUCT LINE UP

TLG336S/TLG337S	GaP GREEN
TLS336S/TLS337S	GaAsP RED
TLR336S/TLR337S	GaP RED

## TYPE No. vs FULLY DISPLAY FONT

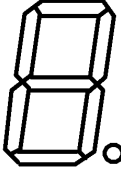
COMMON CATHODE	COMMON ANODE	FULLY DISPLAY FONT
TLG336S TLS336S TLR336S	TLG337S TLS337S TLR337S	

## MAXIMUM RATINGS (Ta = 25°C)

CHARACTERISTIC	SYMBOL	RATING	UNIT
DC Forward Current / seg.	$I_F$ (DC) / seg	20	mA
Pulse Forward Current / seg. (Note)	$I_{FP}$ / seg	110	mA
Reverse Voltage / seg.	$V_R$	6	V
Operating Temperature Range	$T_{opr}$	-40~85	°C
Storage Temperature Range	$T_{stg}$	-40~85	°C

Note : Pulse Width = 1ms, Duty Ratio = 1 / 10

## ELECTRICAL-OPTICAL CHARACTERISTICS (Ta = 25°C)

TYPE No.	EMITTING WAVE LENGTH			LUMINOUS INTENSITY I <sub>V</sub> /seg			FORWARD VOLTAGE V <sub>F</sub> /seg				REVERSE CURRENT I <sub>R</sub> /seg		LUMINOUS INTENSITY MATCHING RATIO I <sub>V-M</sub>	
	λ <sub>p</sub>	Δλ	I <sub>F</sub> /seg	Min.	Typ.	I <sub>F</sub> /seg	Min.	Typ.	Max.	I <sub>F</sub> /seg	Max.	V <sub>R</sub> /seg	Max.	I <sub>F</sub> /seg
TLG Series	565	30	10	0.47	1.06	10	1.7	2.0	2.5	10	5	6	2.3	10
TLS Series	635	40		1.06	2.40		1.7	1.9	2.5					
TLR Series	700	100		0.21	0.48		5	1.4	2.0					
UNIT	nm		mA	mcd		mA	V			mA	μA	V	—	mA

## PRECAUTION

Please be careful of the following.

- Soldering temperature should be less than 260°C for 3 seconds at 2.0mm from the seating plane.

**$I_V/seg - I_F$**

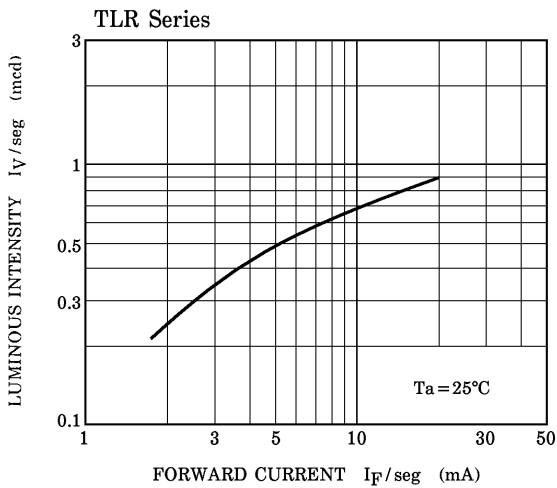
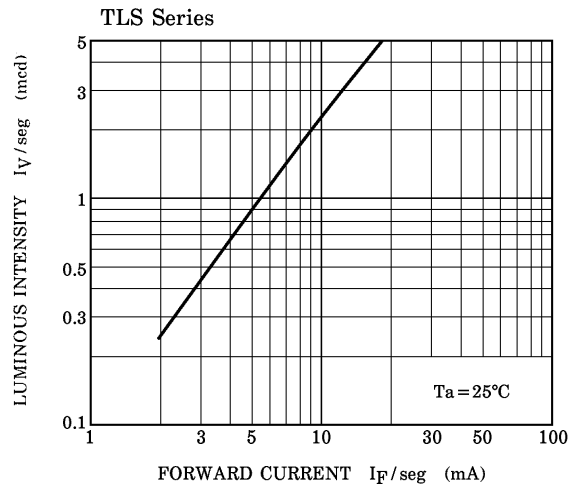
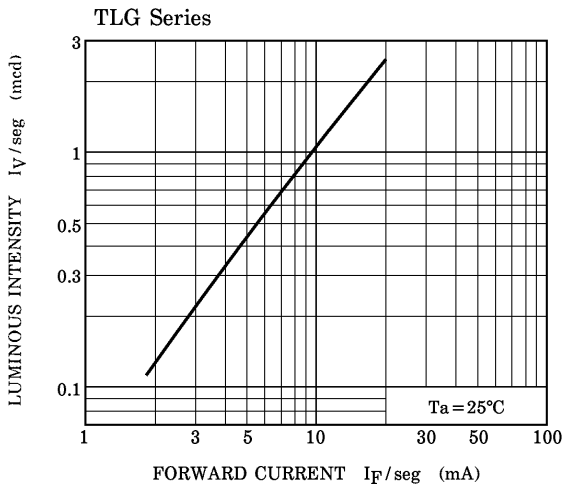

**$I_V/seg - D_R$**

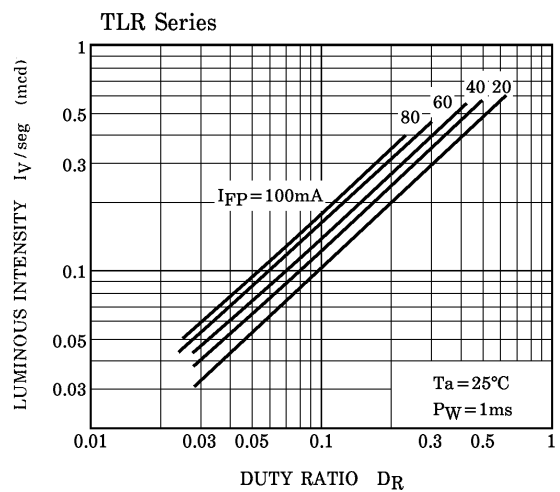
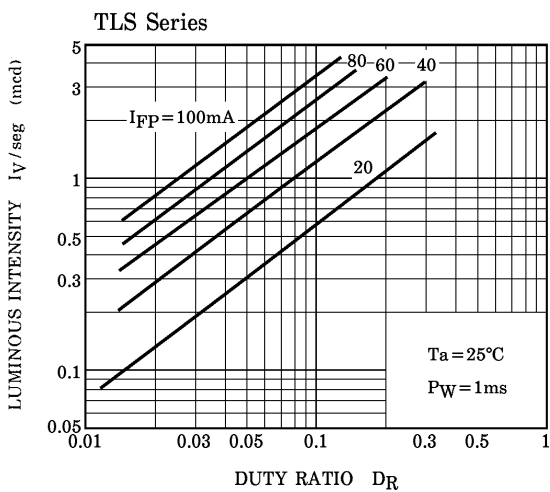
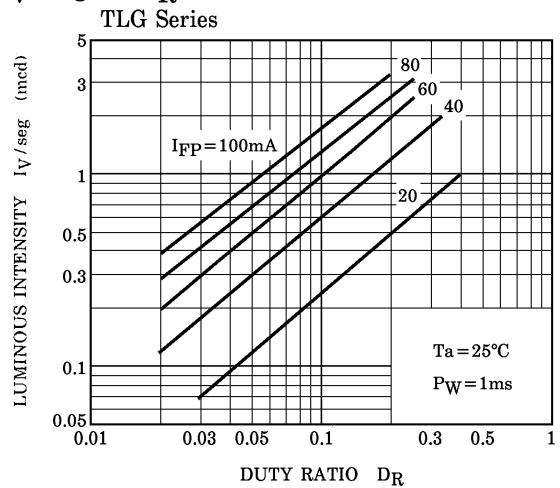

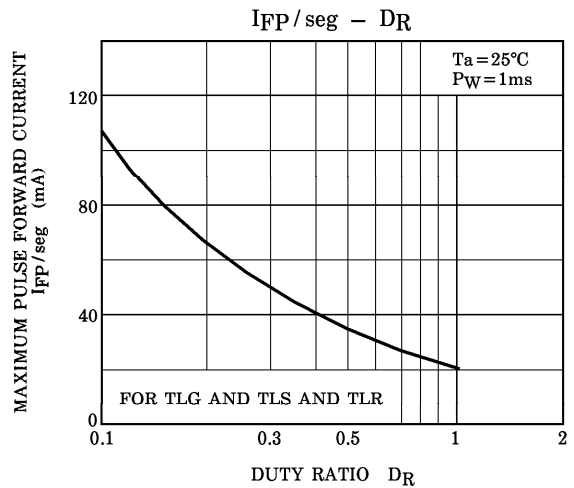
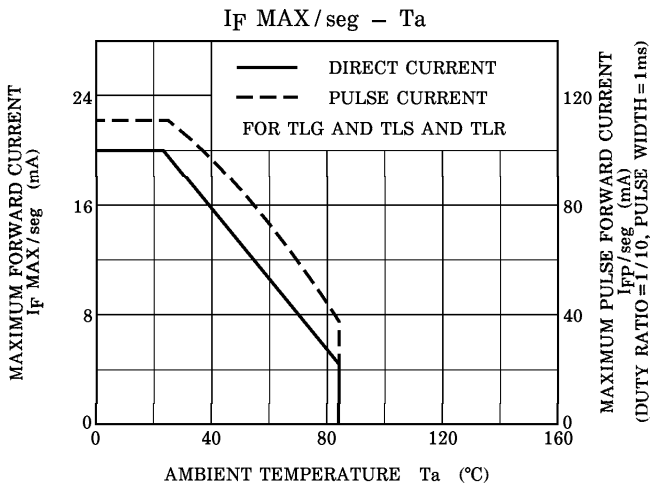
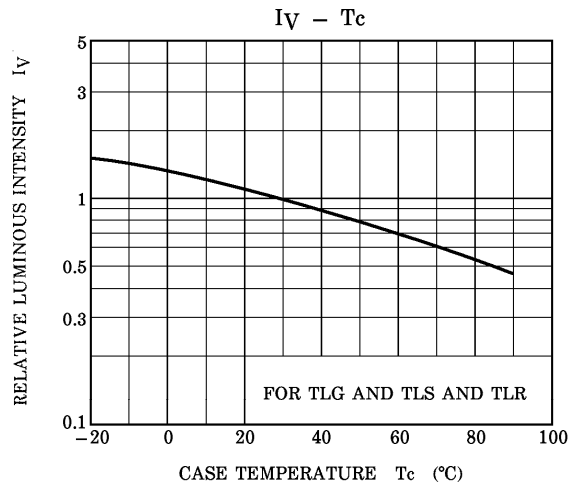
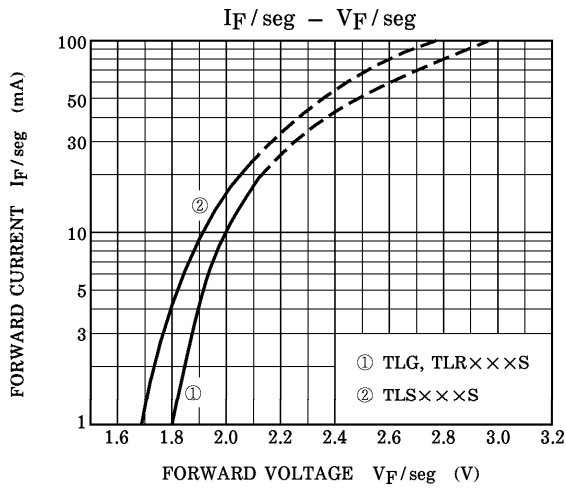

OUTLINE DIMENSIONS

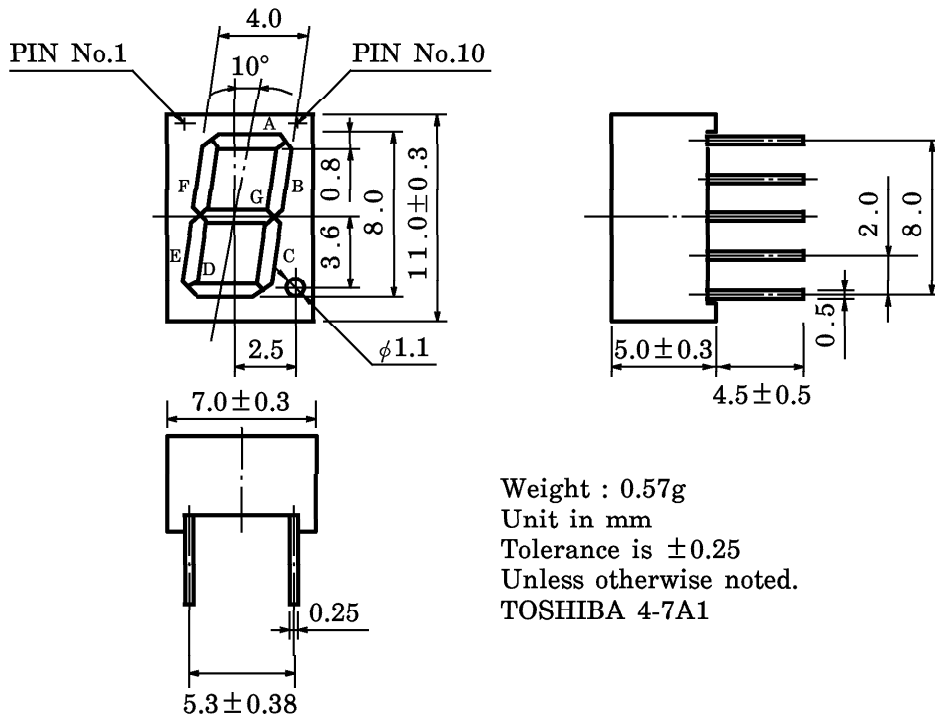

PIN CONNECTION

336S Series		337S Series	
PIN No.	CONNECTION	PIN No.	CONNECTION
1	Anode A	1	Cathode A
2	Anode F	2	Cathode F
3	Anode G	3	Cathode G
4	Anode E	4	Cathode E
5	Anode D	5	Cathode D
6	Cathode Dp (Right Hand)	6	Cathode Dp (Right Hand)
7	Anode Dp (Right Hand)	7	Anode Dp (Right Hand)
8	Anode C	8	Cathode C
9	Common Cathode	9	Common Anode
10	Anode B	10	Cathode B

**RESTRICTIONS ON PRODUCT USE**

000707EAC

- TOSHIBA is continually working to improve the quality and reliability of its products. Nevertheless, semiconductor devices in general can malfunction or fail due to their inherent electrical sensitivity and vulnerability to physical stress. It is the responsibility of the buyer, when utilizing TOSHIBA products, to comply with the standards of safety in making a safe design for the entire system, and to avoid situations in which a malfunction or failure of such TOSHIBA products could cause loss of human life, bodily injury or damage to property. In developing your designs, please ensure that TOSHIBA products are used within specified operating ranges as set forth in the most recent TOSHIBA products specifications. Also, please keep in mind the precautions and conditions set forth in the "Handling Guide for Semiconductor Devices," or "TOSHIBA Semiconductor Reliability Handbook" etc..
- The TOSHIBA products listed in this document are intended for usage in general electronics applications (computer, personal equipment, office equipment, measuring equipment, industrial robotics, domestic appliances, etc.). These TOSHIBA products are neither intended nor warranted for usage in equipment that requires extraordinarily high quality and/or reliability or a malfunction or failure of which may cause loss of human life or bodily injury ("Unintended Usage"). Unintended Usage include atomic energy control instruments, airplane or spaceship instruments, transportation instruments, traffic signal instruments, combustion control instruments, medical instruments, all types of safety devices, etc.. Unintended Usage of TOSHIBA products listed in this document shall be made at the customer's own risk.
- Gallium arsenide (GaAs) is a substance used in the products described in this document. GaAs dust and fumes are toxic. Do not break, cut or pulverize the product, or use chemicals to dissolve them. When disposing of the products, follow the appropriate regulations. Do not dispose of the products with other industrial waste or with domestic garbage.
- The information contained herein is presented only as a guide for the applications of our products. No responsibility is assumed by TOSHIBA CORPORATION for any infringements of intellectual property or other rights of the third parties which may result from its use. No license is granted by implication or otherwise under any intellectual property or other rights of TOSHIBA CORPORATION or others.
- The information contained herein is subject to change without notice.