

TOSHIBA LED Lamps

**TLRE1008A(T04), TLSE1008A(T04),
TLOE1008A(T04), TLYE1008A(T04), TLPYE1008A(T04),
TLGE1008A(T04), TLFGE1008A(T04), TLPGE1008A(T04)**

Panel Circuit Indicators

- Surface-mount devices
- 1.6 (L) mm × 0.8 (W) mm × 0.6 (H) mm
- InGaAlP LEDs
- Replacing standard-intensity LEDs with high-intensity ones helps increase the brightness or reduce the power consumption of end products.
- Colors: red, orange, yellow, pure yellow, green, pure green
- Applications:
 - Backlighting for battery-powered equipment
 - Pilot lamps for mobile handsets
 - Low-power electronic equipment, etc.
- Standard embossed tape packing: T04 (4000/reel)
4-mm tape reel

Color and Material

Part Number	Color	Material
TLRE1008A	Red	InGaAlP
TLSE1008A	Red	
TLOE1008A	Orange	
TLYE1008A	Yellow	
TLPYE1008A	Pure Yellow	
TLGE1008A	Green	
TLFGE1008A	Green	
TLPGE1008A	Pure Green	

Unit: mm

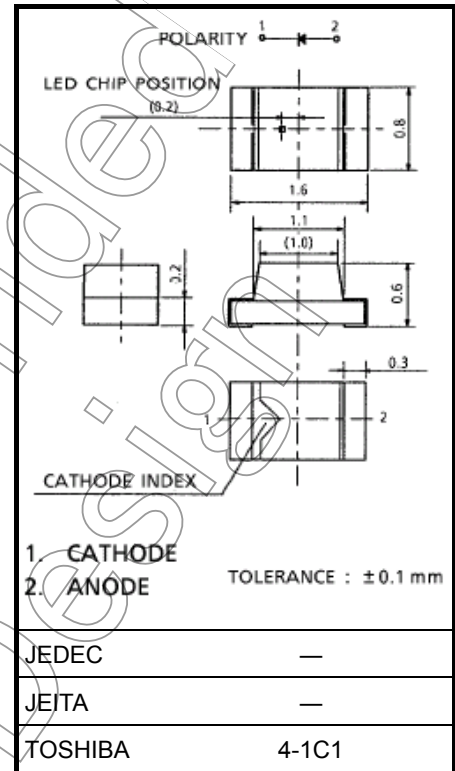

Weight: 0.0013 g (typ.)

Absolute Maximum Ratings (Ta = 25°C)

Part Number	Forward Current I _F (mA) Please see Note 1	Reverse Voltage V _R (V)	Power Dissipation P _D (mW)	Operation Temperature T _{opr} (°C)	Storage Temperature T _{stg} (°C)
TLRE1008A	25	4	60	-40 to 85	-40 to 100
TLSE1008A					
TLOE1008A					
TLYE1008A					
TLPYE1008A					
TLGE1008A					
TLFGE1008A					
TLPGE1008A					

Note: Using continuously under heavy loads (e.g. the application of high temperature/current/voltage and the significant change in temperature, etc.) may cause this product to decrease in the reliability significantly even if the operating conditions (i.e. operating temperature/current/voltage, etc.) are within the absolute maximum ratings.

Please design the appropriate reliability upon reviewing the Toshiba Semiconductor Reliability Handbook ("Handling Precautions"/"Derating Concept and Methods") and individual reliability data (i.e. reliability test report and estimated failure rate, etc).

Note 1: Forward current derating

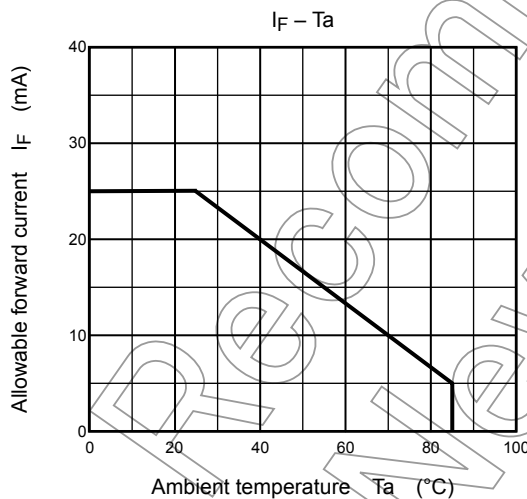

Electrical Characteristics (Ta = 25°C)

Part Number	Forward Voltage V _F			I _F	Reverse Current I _R	
	Min	Typ.	Max		Max	V _R
TLRE1008A	1.6	1.9	2.4	20	50	4
TLSE1008A	1.6	1.9	2.4			
TLOE1008A	1.6	2.0	2.4			
TLYE1008A	1.6	2.0	2.4			
TLPYE1008A	1.6	2.0	2.4			
TLGE1008A	1.6	2.0	2.4			
TLFGE1008A	1.6	2.0	2.4			
TLPGE1008A	1.6	2.1	2.4			
Unit	V			mA	μA	V

Optical Characteristics–1 (Ta = 25°C)

Part Number	Luminous Intensity I _v				Available I _v rank Please see Note 2
	Min	Typ.	Max	I _F	
TLRE1008A	27.2	70	—	20	L / M / N / P
TLSE1008A	47.6	135	—	20	M / N / P / Q
TLOE1008A	47.6	150	—	20	M / N / P / Q
TLYE1008A	27.2	105	—	20	L / M / N / P
TLPYE1008A	27.2	100	—	20	L / M / N / P
TLGE1008A	27.2	70	—	20	L / M / N / P
TLFGE1008A	15.3	40	—	20	K / L / M / N
TLPGE1008A	4.76	18	—	20	H / J / K / L
Unit	mcd	mcd	mcd	mA	—

Note 2: The specification on the above table is used for I_v classification of LEDs in Toshiba facility.
Each reel includes the same rank LEDs. Let the delivery ratio of each rank be unquestioned.

Rank	Luminous Intensity I _v	
	Min	Max
H	4.76	12.9
J	8.5	23
K	15.3	41.4
L	27.2	73.6
M	47.6	129
N	85	230
P	153	414
Q	272	736
Unit	mcd	mcd

Optical Characteristics–2 (Ta = 25°C)

Part Number	Emission Spectrum							
	Peak Emission Wavelength λ _p			Δλ	Dominant Wavelength λ _d			I _F
	Min	Typ.	Max		Typ.	Min	Typ.	
TLRE1008A	—	644	—	18	624	630	638	20
TLSE1008A	—	623	—	15	607	613	621	
TLOE1008A	—	612	—	15	599	605	613	
TLYE1008A	—	590	—	13	581	587	595	
TLPYE1008A	—	583	—	13	574	580	586	
TLGE1008A	—	574	—	11	565	571	576	
TLFGE1008A	—	568	—	11	559	565	571	
TLPGE1008A	—	562	—	11	—	558	564	
Unit	nm			nm	nm			mA

The cautions

- This visible LED lamp also emits some IR light.
If a photodetector is located near the LED lamp, please ensure that it will not be affected by the IR light.
- This product is designed as a general display light source usage, and it has applied the measurement standard that matched with the sensitivity of human's eyes. Therefore, it is not intended for usage of functional application (ex. Light source for sensor, optical communication and etc) except general display light source.

TLRE1008A

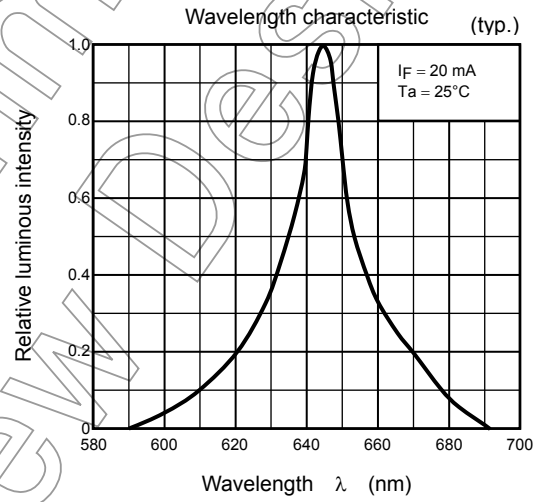
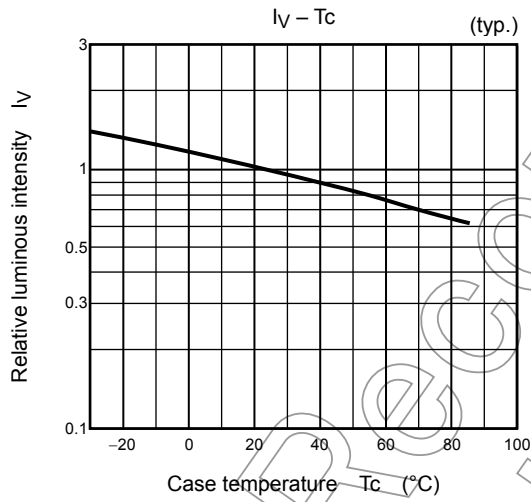
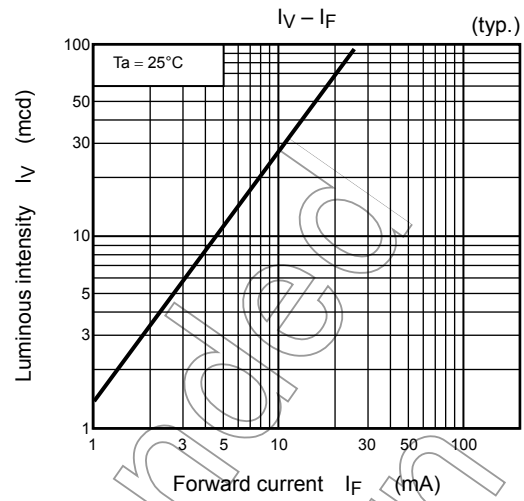
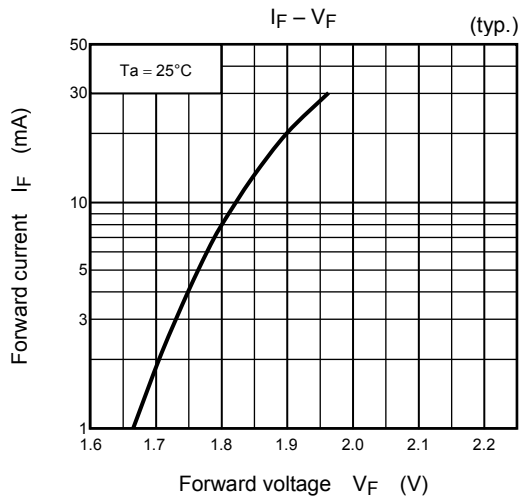

Not for New Commercial Use

TLSE1008A

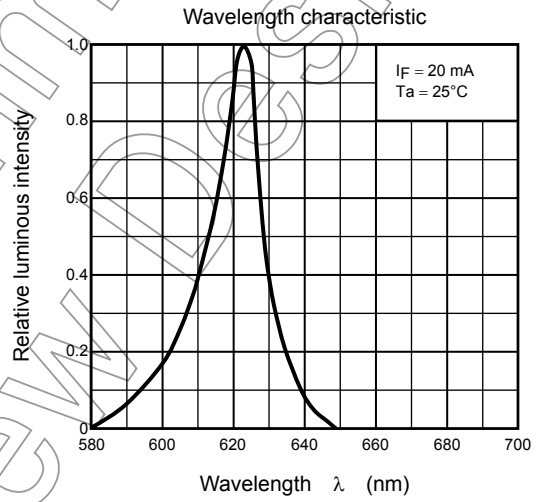
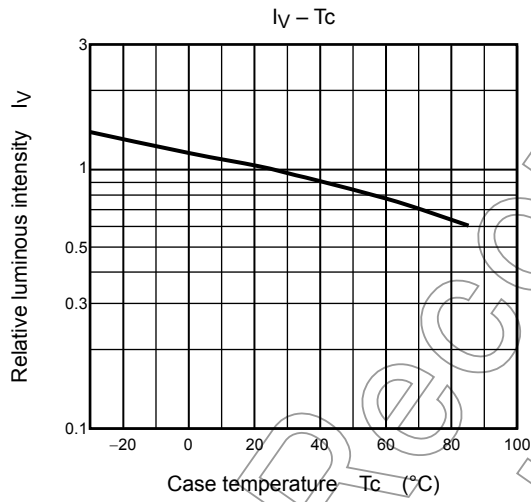
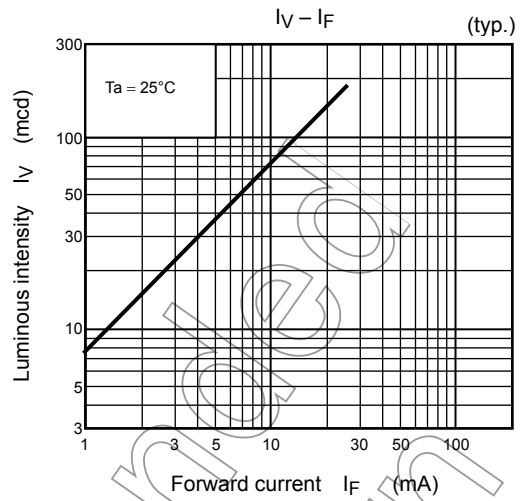
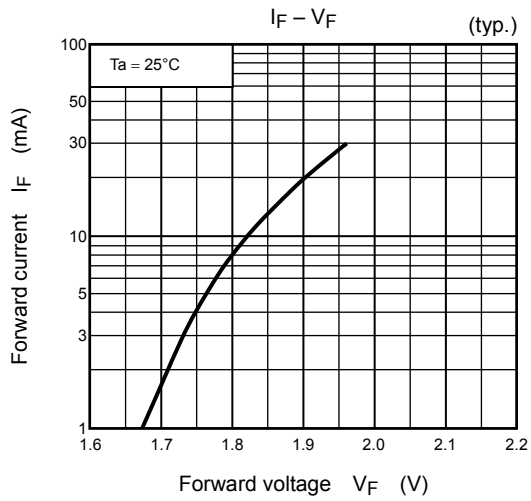

Not for New Commercial Use

TLOE1008A

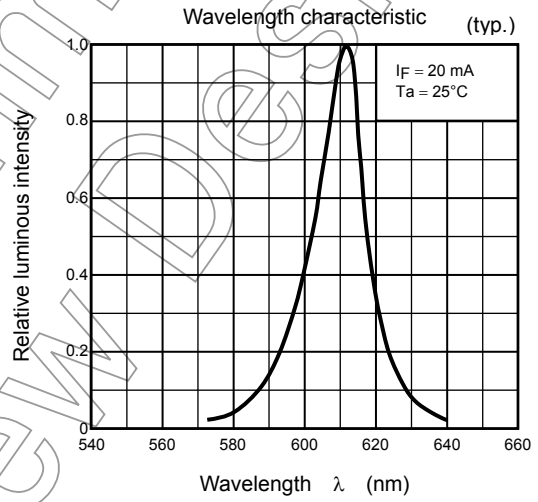
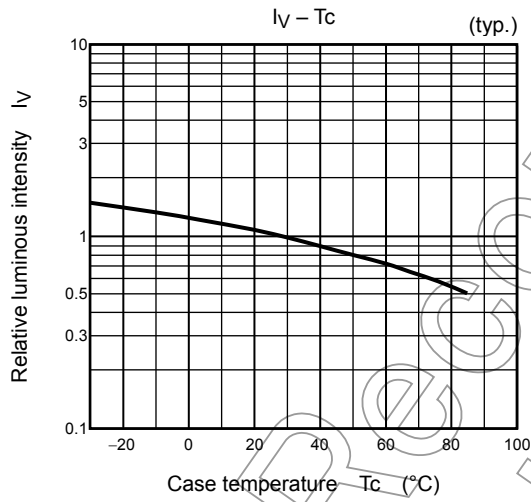
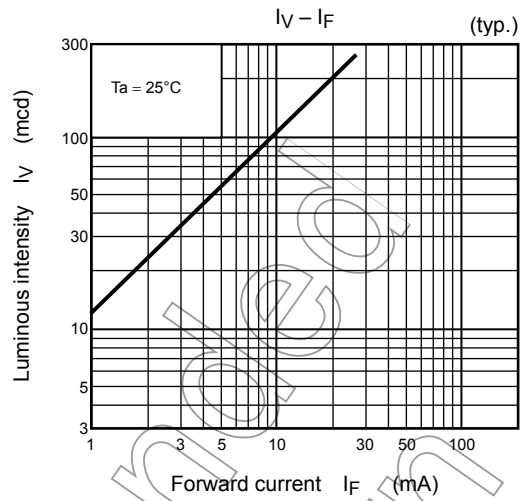
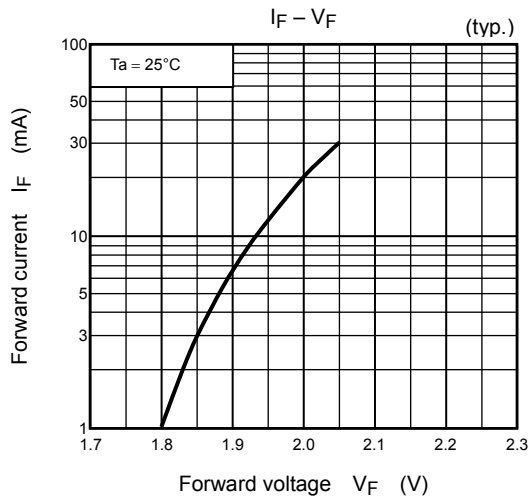

Not for New

TLYE1008A

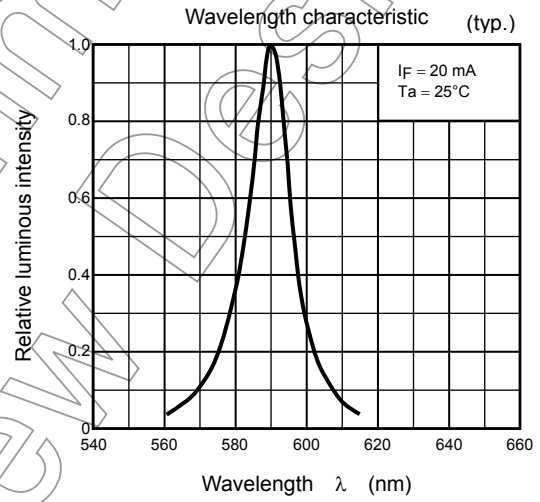
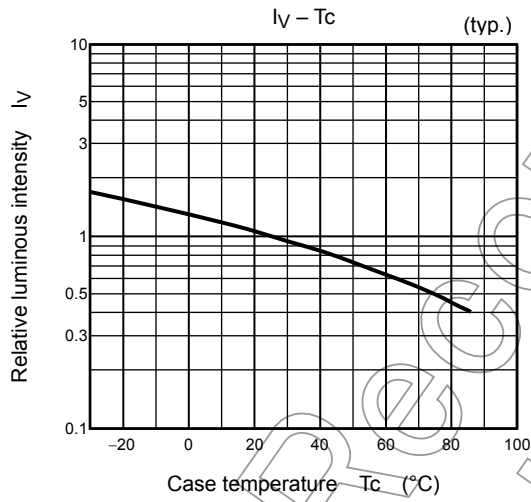
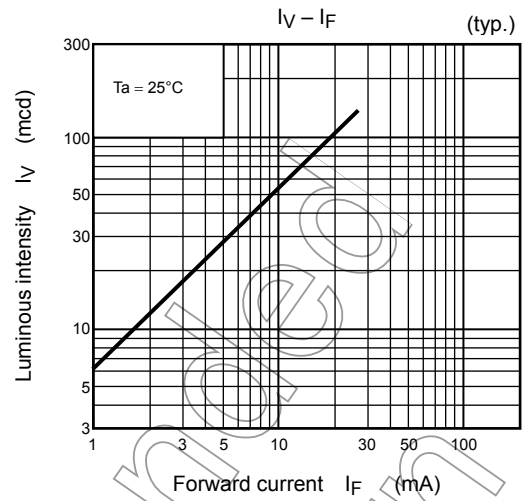
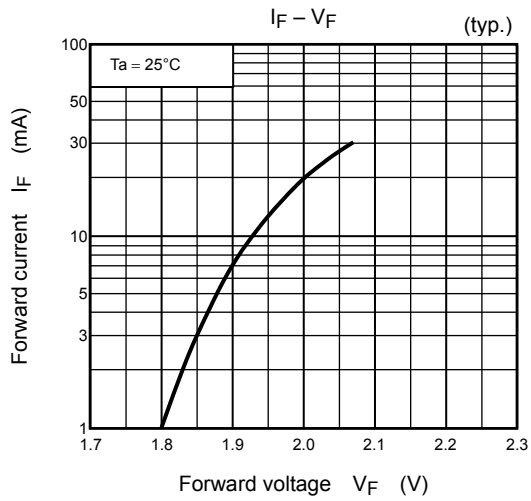

Not for New

TLPYE1008A

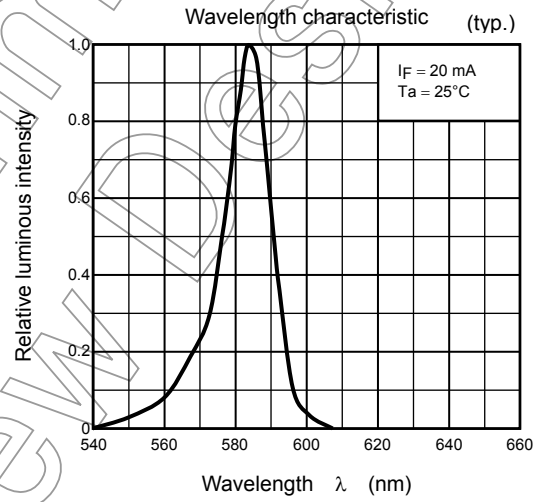
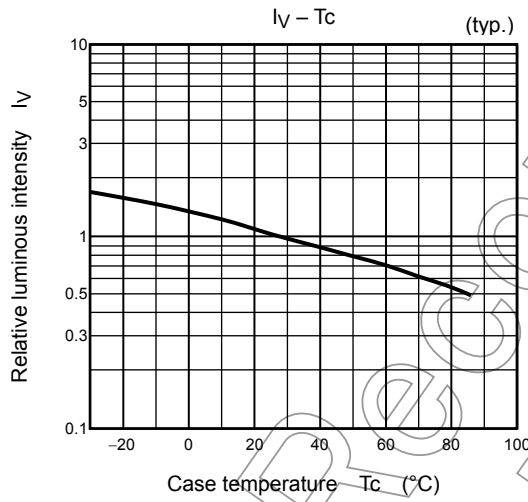
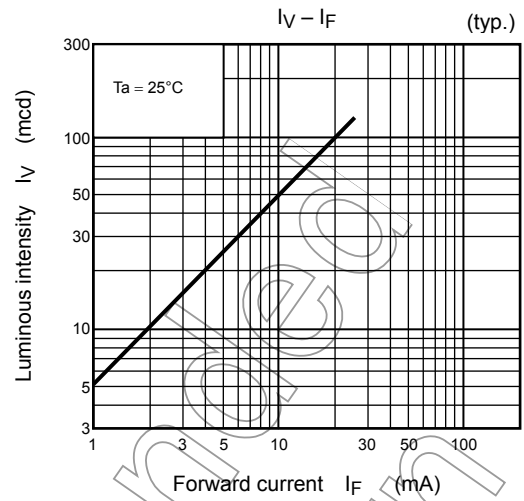
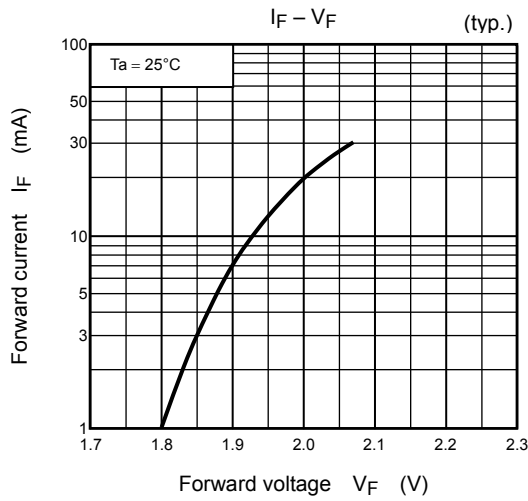

Not for New

TLGE1008A

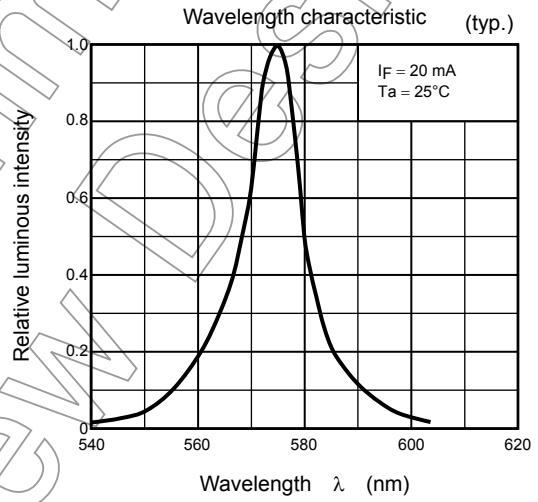
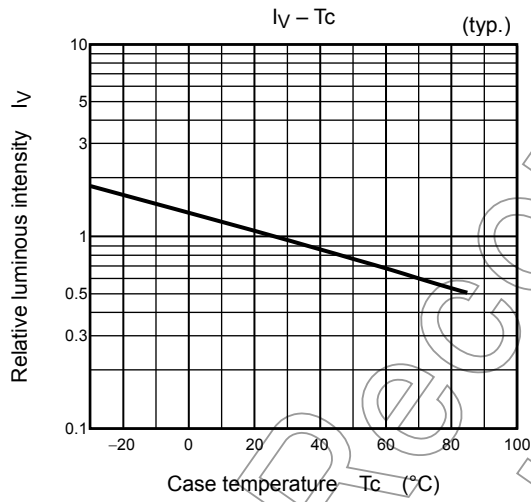
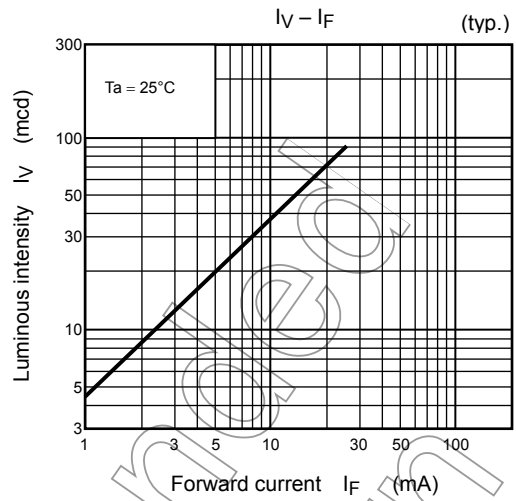
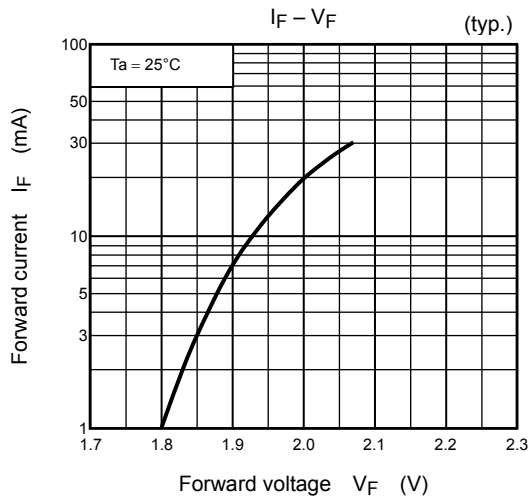

Not for New

TLFGE1008A

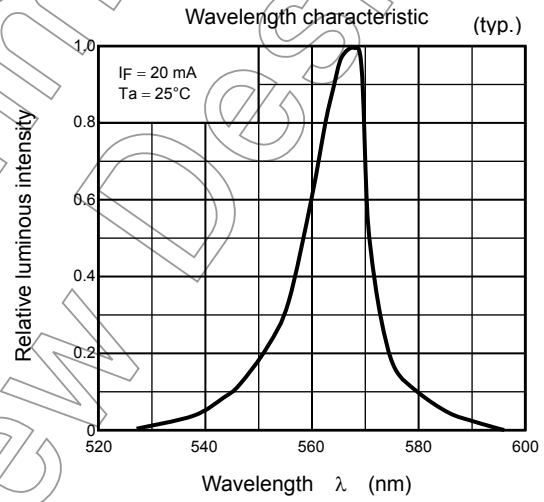
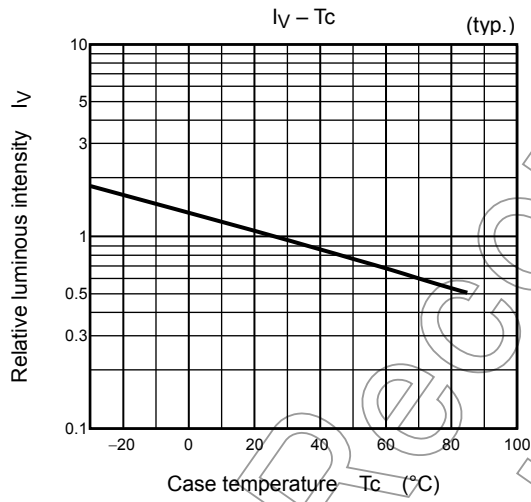
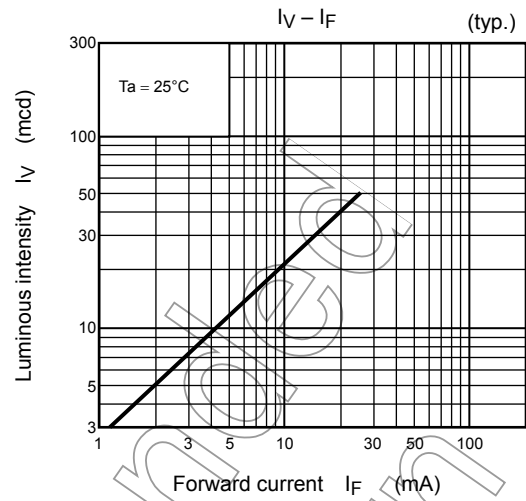
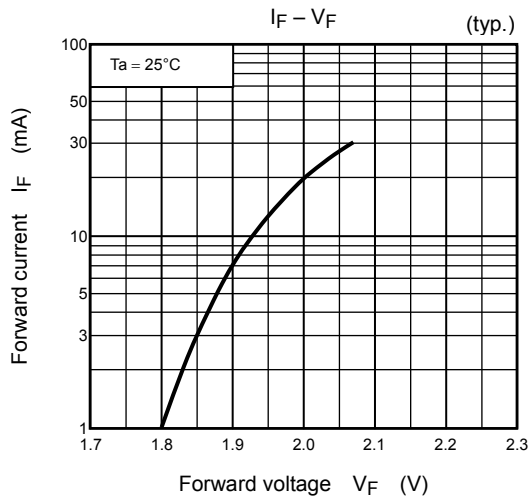

Not for Newshommes.com

TLPGE1008A

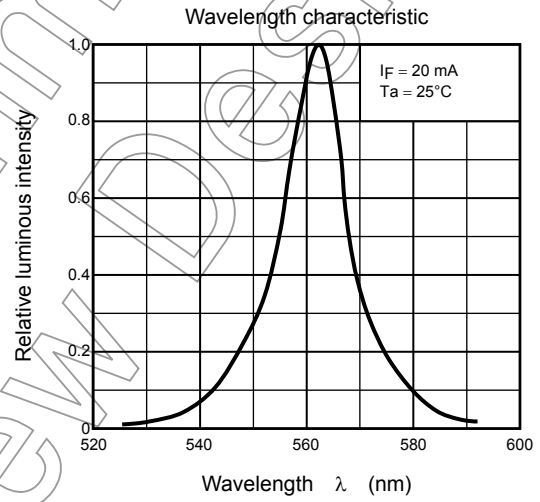
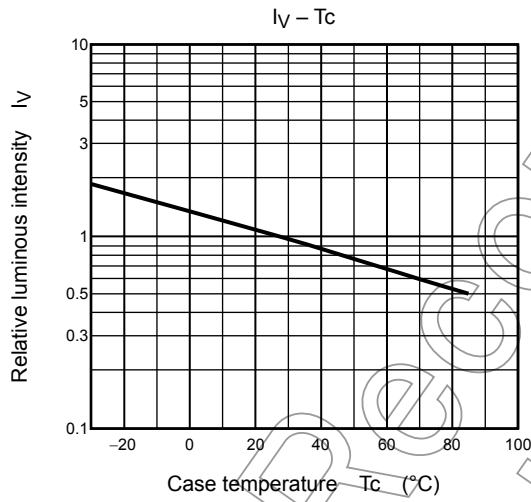
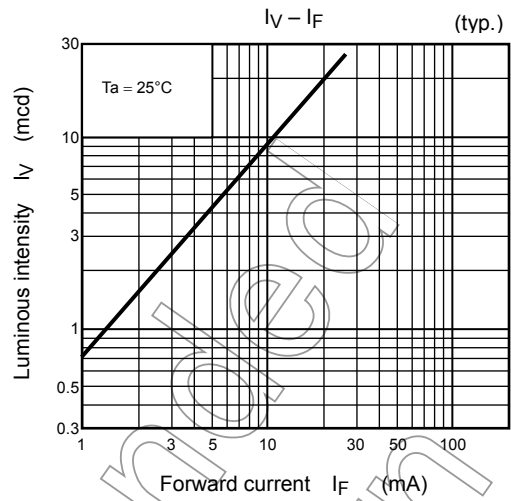
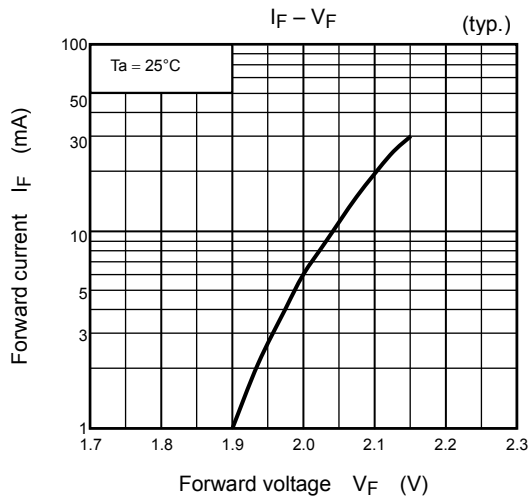

Not for New

Radiation Pattern

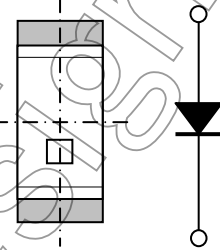
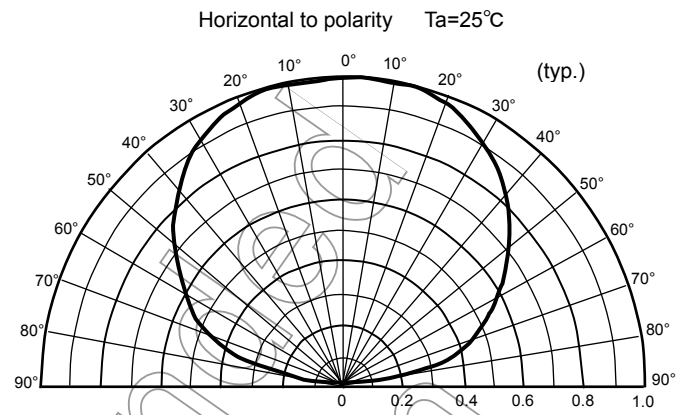
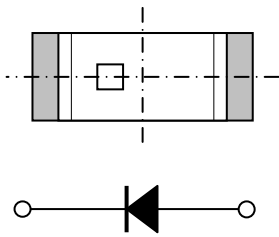
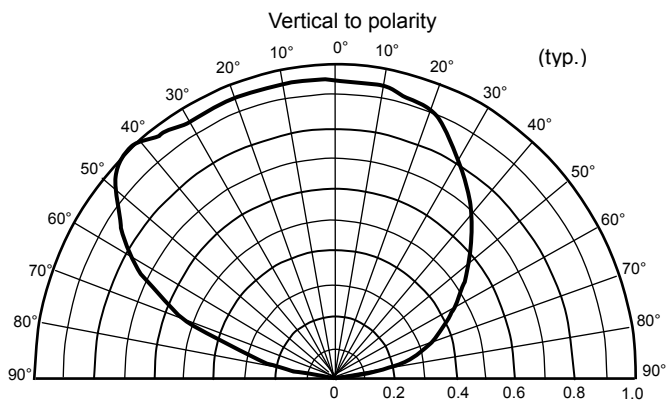

Not Recommended for New Design

Packaging

These LED devices are packed in an aluminum envelope with a silica gel and a moisture indicator to avoid moisture absorption. The optical characteristics of the devices may be affected by exposure to moisture in the air before soldering and they should therefore be stored under the following conditions:

1. This moisture proof bag may be stored unopened within 12 months at the following conditions.
 Temperature: 5°C to 30°C
 Humidity: 90% (max)
2. After opening the moisture proof bag, the devices should be assembled within 168 hours in an environment of 5°C to 30°C/70% RH or below.
 When performing lead(Pb)-free soldering, the devices should be assembled within 72 hours in an environment of 5°C to 30°C/70% RH or below.
3. If upon opening, the moisture indicator card shows humidity 30% or above (Color of indication changes to pink) or the expiration date has passed, the devices should be baked in taping with reel.
 After baking, use the baked devices within 72 hours, but perform baking only once.
 Baking conditions: 60±5°C, for 12 to 24 hours.
 Expiration date: 12 months from sealing date, which is imprinted on the same side as this label affixed.
4. Repeated baking can cause the peeling strength of the taping to change, then leads to trouble in mounting.
 Furthermore, prevent the devices from being destructed against static electricity for baking of it.
5. If the packing material of laminate would be broken, the air tightness would deteriorate. Therefore, do not throw or drop the packed devices.

Mounting Method

Soldering

- Reflow soldering (example)

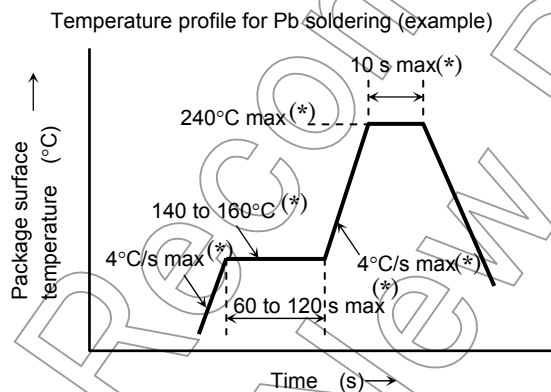

- The products are evaluated using above reflow soldering conditions. No additional test is performed exceed the condition (i.e. the condition more than (*)MAX values) as a evaluation. Please perform reflow soldering under the above conditions.
- Please perform the first reflow soldering with reference to the above temperature profile and within 168 h of opening the package.
- Second reflow soldering
 In case of second reflow soldering should be performed within 168 h of the first reflow under the above conditions.
 Storage conditions before the second reflow soldering: 30°C, 70% RH (max)
- Make any necessary soldering corrections manually.
 (only once at each soldering point)
 Soldering iron: 25 W
 Temperature: 300°C or less
 Time: within 3 s
- Do not perform wave soldering.

- Reflow soldering (example)

Temperature profile for Pb-free soldering (example)

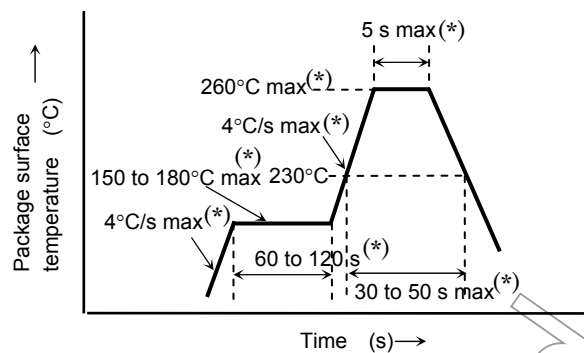

- The products are evaluated using above reflow soldering conditions. No additional test is performed exceed the condition (i.e. the condition more than (*)MAX values) as a evaluation. Please perform reflow soldering under the above conditions.
- Please perform the first reflow soldering with reference to the above temperature profile and within 72 h of opening the package.
- Second reflow soldering
In case of second reflow soldering should be performed within 72 h of the first reflow under the above conditions. Storage conditions before the second reflow soldering: 30°C, 70% RH (max)
- Make any necessary soldering corrections manually.
(only once at each soldering point)
Soldering iron: 25 W
Temperature: 300°C or less
Time: within 3 s
- Do not perform wave soldering.

Recommended Soldering Pattern

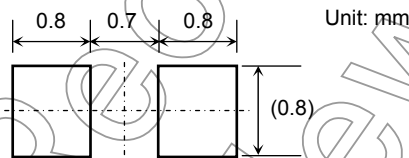

Cleaning

When cleaning is required after soldering, Toshiba recommends the following cleaning solvents. It is confirmed that these solvents have no effect on semiconductor devices in our dipping test (under the recommended conditions). In selecting the one for your actual usage, please perform sufficient review on washing condition, using condition and etc.

ASAHI CLEAN AK-225AES:	(made by ASAHI GLASS)
KAO CLEAN THROUGH 750H:	(made by KAO)
PINE ALPHA ST-100S:	(made by ARAKAWA CHEMICAL)

Precaution When Mounting

Do not apply force to the plastic part of the LED under high-temperature conditions. To avoid damaging the LED plastic, do not apply friction using a hard material. When installing the PCB in a product, ensure that the device does not come into contact with other components.

Tape Specifications

1. Product Number Format

The type of package used for shipment is denoted by a symbol suffix after the product number. The method of classification is as below. (However, this method does not apply to products whose electrical/optical characteristics differ from standard Toshiba specifications)

- (1) Tape Type: T04 (4-mm pitch)
- (2) Example

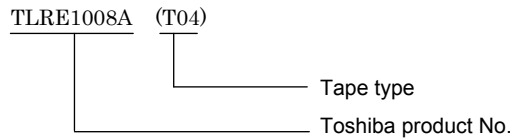

2. Handling Precautions

Tape material protected against static electricity. However, static electricity may occur depending on quantity of charged static electricity and a device may attach to a tape, or a device may be unstable when peeling a tape cover.

- (a) Since tape materials may accumulate an electrostatic charge, use an ionizer to neutralize the ambient air.
- (b) For transport and temporary storage of devices, use containers (boxes and bags) and jigs that are made of anti-static materials or of materials which dissipate electrostatic charge.

3. Tape Dimensions

Unit: mm

Symbol	Value	Tolerance	Symbol	Value	Tolerance
D	1.50	+0.1/-0	P ₂	2.00	±0.05
E	1.75	±0.1	W	8.00	±0.1
P ₀	4.00	±0.1	P	4.00	±0.1
t	0.20	±0.05	A ₀	0.90	±0.1
F	3.50	±0.05	B ₀	1.75	±0.1
D ₁	0.60	±0.05	K ₀	0.75	±0.1

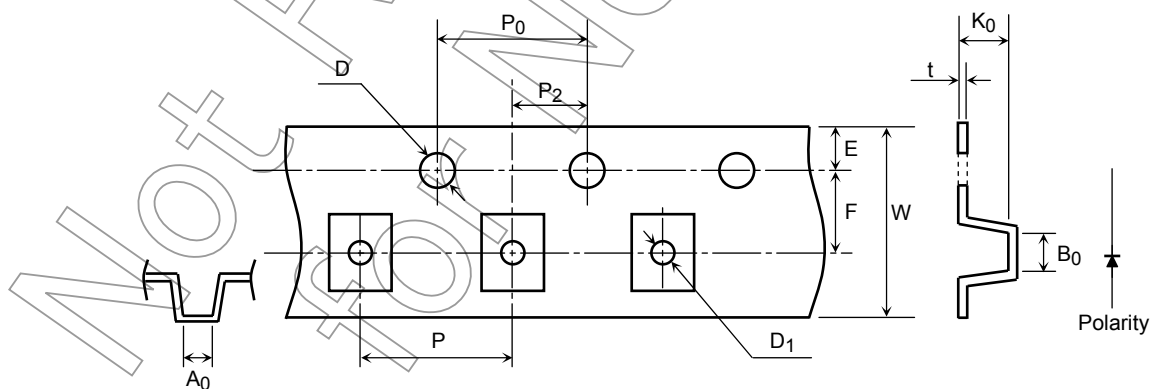

4. Reel Dimensions

Unit: mm

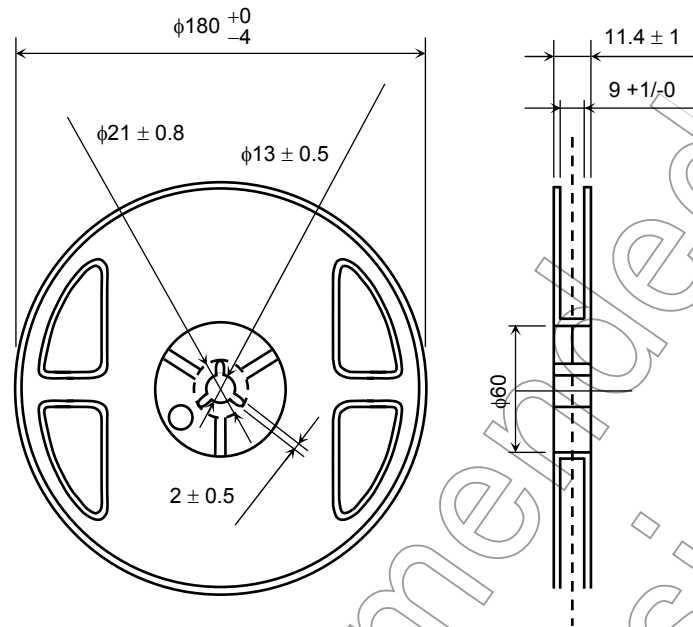

5. Leader and Trailer Section of Tape

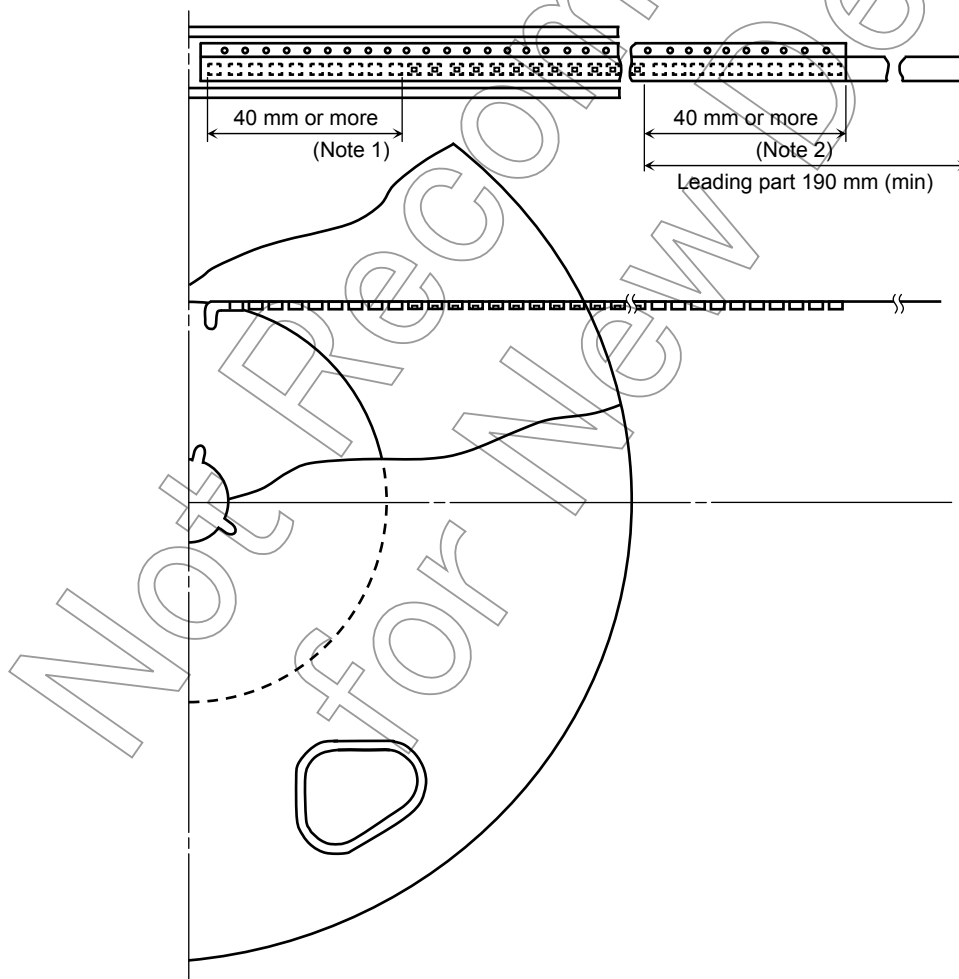

Note 1: Empty trailer section

Note 2: Empty leader section

6. Packing Display

(1) Packing quantity

Reel	4,000 pcs
Carton	20,000 pcs

(2) Package form: Each reel is sealed in an aluminum pack with silica gel.

7. Label Format

(1) Example: TLRE1008A (T04)



P/N:

TYPE	TLRE1008A		
ADDC	(T04)	Q'TY	4,000 pcs

Lot Number Key code for TSB 32C 4000
(RANK SYMBOL)

Use under 5-30degC/70%RH within 72h

[[G]]/RoHS COMPATIBLE SEALED
Y380xxxxxxxxxxxxxxxxxxxx DIFFUSED IN *****
ASSEMBLED IN *****

(2) Label location

• Reel

• Carton

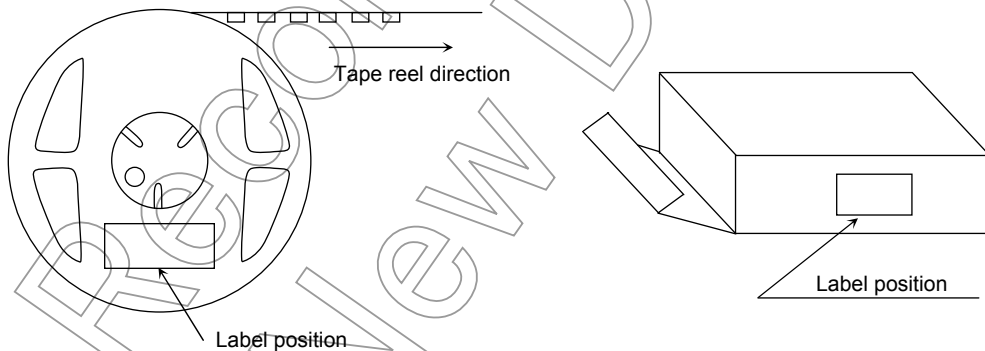

• The aluminum package in which the reel is supplied also has a copy of the label attached to center of one side.

Not for New Design

RESTRICTIONS ON PRODUCT USE

- Toshiba Corporation, and its subsidiaries and affiliates (collectively "TOSHIBA"), reserve the right to make changes to the information in this document, and related hardware, software and systems (collectively "Product") without notice.
- This document and any information herein may not be reproduced without prior written permission from TOSHIBA. Even with TOSHIBA's written permission, reproduction is permissible only if reproduction is without alteration/omission.
- Though TOSHIBA works continually to improve Product's quality and reliability, Product can malfunction or fail. Customers are responsible for complying with safety standards and for providing adequate designs and safeguards for their hardware, software and systems which minimize risk and avoid situations in which a malfunction or failure of Product could cause loss of human life, bodily injury or damage to property, including data loss or corruption. Before creating and producing designs and using, customers must also refer to and comply with (a) the latest versions of all relevant TOSHIBA information, including without limitation, this document, the specifications, the data sheets and application notes for Product and the precautions and conditions set forth in the "TOSHIBA Semiconductor Reliability Handbook" and (b) the instructions for the application that Product will be used with or for. Customers are solely responsible for all aspects of their own product design or applications, including but not limited to (a) determining the appropriateness of the use of this Product in such design or applications; (b) evaluating and determining the applicability of any information contained in this document, or in charts, diagrams, programs, algorithms, sample application circuits, or any other referenced documents; and (c) validating all operating parameters for such designs and applications. **TOSHIBA ASSUMES NO LIABILITY FOR CUSTOMERS' PRODUCT DESIGN OR APPLICATIONS.**
- Product is intended for use in general electronics applications (e.g., computers, personal equipment, office equipment, measuring equipment, industrial robots and home electronics appliances) or for specific applications as expressly stated in this document. Product is neither intended nor warranted for use in equipment or systems that require extraordinarily high levels of quality and/or reliability and/or a malfunction or failure of which may cause loss of human life, bodily injury, serious property damage or serious public impact ("Unintended Use"). Unintended Use includes, without limitation, equipment used in nuclear facilities, equipment used in the aerospace industry, medical equipment, equipment used for automobiles, trains, ships and other transportation, traffic signaling equipment, equipment used to control combustions or explosions, safety devices, elevators and escalators, devices related to electric power, and equipment used in finance-related fields. Do not use Product for Unintended Use unless specifically permitted in this document.
- Do not disassemble, analyze, reverse-engineer, alter, modify, translate or copy Product, whether in whole or in part.
- Product shall not be used for or incorporated into any products or systems whose manufacture, use, or sale is prohibited under any applicable laws or regulations.
- The information contained herein is presented only as guidance for Product use. No responsibility is assumed by TOSHIBA for any infringement of patents or any other intellectual property rights of third parties that may result from the use of Product. No license to any intellectual property right is granted by this document, whether express or implied, by estoppel or otherwise.
- **ABSENT A WRITTEN SIGNED AGREEMENT, EXCEPT AS PROVIDED IN THE RELEVANT TERMS AND CONDITIONS OF SALE FOR PRODUCT, AND TO THE MAXIMUM EXTENT ALLOWABLE BY LAW, TOSHIBA (1) ASSUMES NO LIABILITY WHATSOEVER, INCLUDING WITHOUT LIMITATION, INDIRECT, CONSEQUENTIAL, SPECIAL, OR INCIDENTAL DAMAGES OR LOSS, INCLUDING WITHOUT LIMITATION, LOSS OF PROFITS, LOSS OF OPPORTUNITIES, BUSINESS INTERRUPTION AND LOSS OF DATA, AND (2) DISCLAIMS ANY AND ALL EXPRESS OR IMPLIED WARRANTIES AND CONDITIONS RELATED TO SALE, USE OF PRODUCT, OR INFORMATION, INCLUDING WARRANTIES OR CONDITIONS OF MERCHANTABILITY, FITNESS FOR A PARTICULAR PURPOSE, ACCURACY OF INFORMATION, OR NONINFRINGEMENT.**
- GaAs (Gallium Arsenide) is used in Product. GaAs is harmful to humans if consumed or absorbed, whether in the form of dust or vapor. Handle with care and do not break, cut, crush, grind, dissolve chemically or otherwise expose GaAs in Product.
- Do not use or otherwise make available Product or related software or technology for any military purposes, including without limitation, for the design, development, use, stockpiling or manufacturing of nuclear, chemical, or biological weapons or missile technology products (mass destruction weapons). Product and related software and technology may be controlled under the Japanese Foreign Exchange and Foreign Trade Law and the U.S. Export Administration Regulations. Export and re-export of Product or related software or technology are strictly prohibited except in compliance with all applicable export laws and regulations.
- Please contact your TOSHIBA sales representative for details as to environmental matters such as the RoHS compatibility of Product. Please use Product in compliance with all applicable laws and regulations that regulate the inclusion or use of controlled substances, including without limitation, the EU RoHS Directive. TOSHIBA assumes no liability for damages or losses occurring as a result of noncompliance with applicable laws and regulations.