

# OPTIREG™ linear voltage regulator TLS115D0LD

## High-precision voltage tracker



Order now



Technical documents



Simulation



Family overview



Support



RoHS

## Features

- 150 mA current capability
- Very high tracking accuracy
- Output voltage adjustable down to 2.0 V
- Stable with ceramic output capacitors
- Very low dropout voltage of typically 250 mV at 150 mA
- Very low current consumption of typically 0.1  $\mu$ A in standby mode
- Overvoltage and undervoltage indication at power good output
- Internally controlled soft start
- Wide input voltage range:  $-16\text{ V} \leq V_{\text{IN}} \leq 45\text{ V}$
- Wide temperature range:  $-40^\circ\text{C} \leq T_{\text{j}} \leq 150^\circ\text{C}$
- Short circuit protected output (to GND and to battery)
- Reverse polarity protected input
- Overtemperature protection
- Green Product (RoHS compliant)

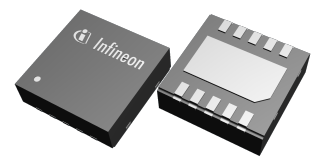

## Potential applications

- Automotive sensor supply
- Protected sensor supply for off-board sensors
- Secondary voltage supply in automotive ECU
- High precision voltage tracking
- Precision voltage replication
- Power switch for off-board load

## Product validation

Qualified for automotive applications. Product validation according to AEC-Q100.

## Description

The OPTIREG™ linear voltage regulator TLS115D0LD is a monolithic, integrated low-dropout voltage tracking regulator with high accuracy in a small PG-TSON-10 package. The TLS115D0LD is designed to supply off-board systems, for example sensors in powertrain management systems under the severe conditions of automotive applications. The TLS115D0LD provides protection functions against reverse polarity as well as against short circuit to GND and to battery. The output voltage follows the reference voltage that is applied to the ADJ input with very high accuracy up to a supply voltage of 45 V and up to an output current of 150 mA. The required minimum reference voltage at ADJ is 2.0 V.

# OPTIREG™ linear voltage regulator TLS115D0LD

## High-precision voltage tracker

---



### Description

Type	Package	Marking
TLS115D0LD	PG-TSON-10	115D0

## Table of contents

	<b>Features</b> .....	1
	<b>Potential applications</b> .....	1
	<b>Product validation</b> .....	1
	<b>Description</b> .....	1
	<b>Table of contents</b> .....	3
<b>1</b>	<b>Block diagram</b> .....	5
<b>2</b>	<b>Pin configuration</b> .....	6
2.1	Pin assignment .....	6
2.2	Pin definitions and functions .....	6
<b>3</b>	<b>General product characteristics</b> .....	8
3.1	Absolute maximum ratings .....	8
3.2	Functional range .....	9
3.3	Thermal resistance .....	9
<b>4</b>	<b>Block description and electrical characteristics</b> .....	11
4.1	Functional description tracking regulator .....	11
4.2	Electrical characteristics tracking regulator .....	12
4.3	Typical performance characteristics tracking regulator .....	14
4.4	Electrical characteristics current consumption .....	17
4.5	Typical performance characteristics current consumption .....	18
4.6	Functional description enable input .....	20
4.7	Electrical characteristics enable input .....	20
4.8	Typical performance characteristics enable input .....	21
4.9	Functional description adjust input .....	22
4.10	Electrical characteristics adjust input .....	22
4.11	Typical performance characteristics adjust input .....	23
4.12	Functional description power good output .....	24
4.13	Electrical characteristics power good output .....	24
<b>5</b>	<b>Application information</b> .....	25
5.1	Application diagram .....	25
5.2	Selection of external components .....	25
5.2.1	Input pin .....	25
5.2.2	Output pin .....	26
5.2.3	Adjust pin .....	26
5.2.4	Power good pin .....	26
5.3	Thermal considerations .....	26
5.4	Further application information .....	27
<b>6</b>	<b>Package information</b> .....	28

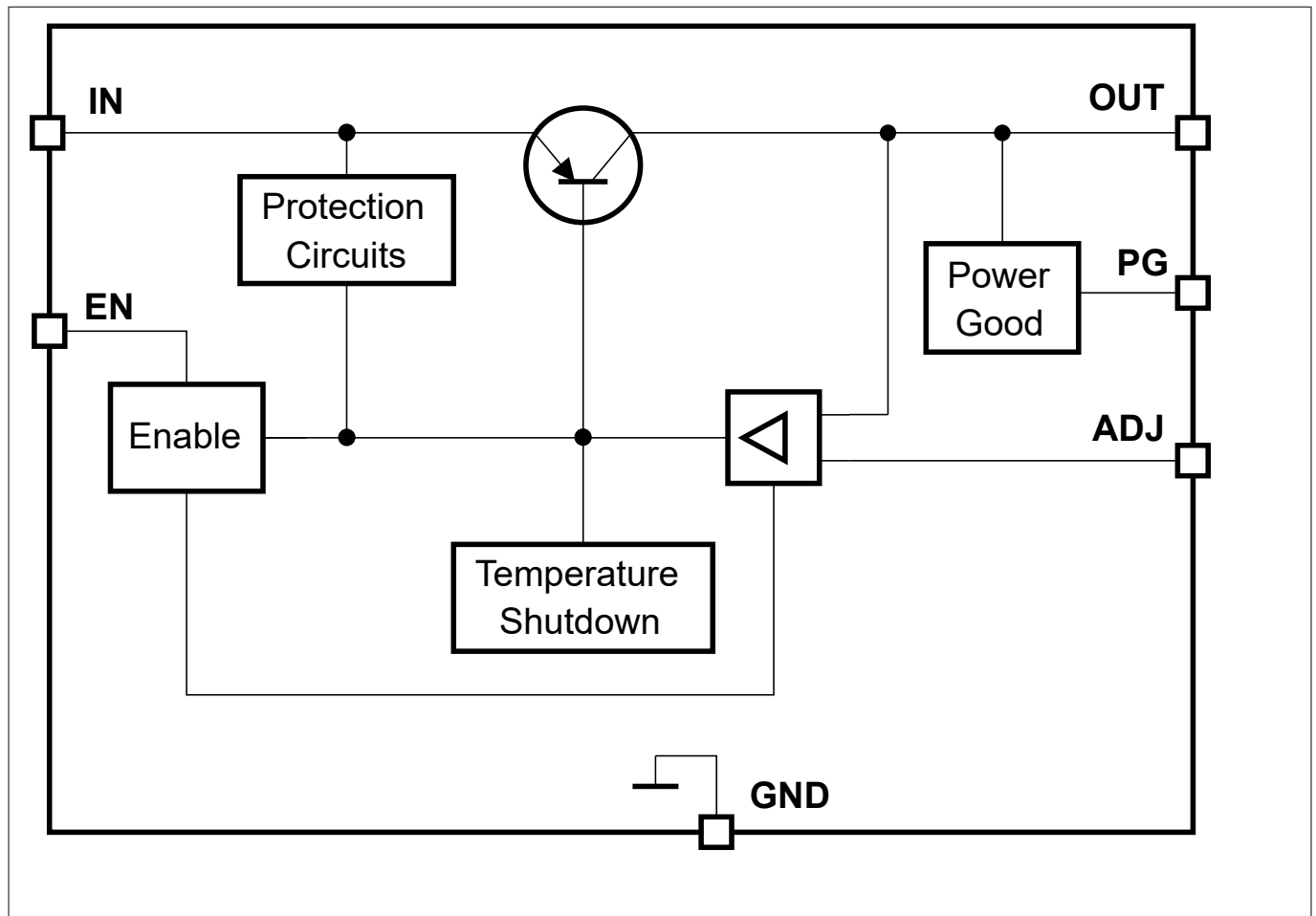

**Table of contents**

<b>Revision history</b> .....	29
<b>Disclaimer</b> .....	30

**1 Block diagram**

**1 Block diagram**

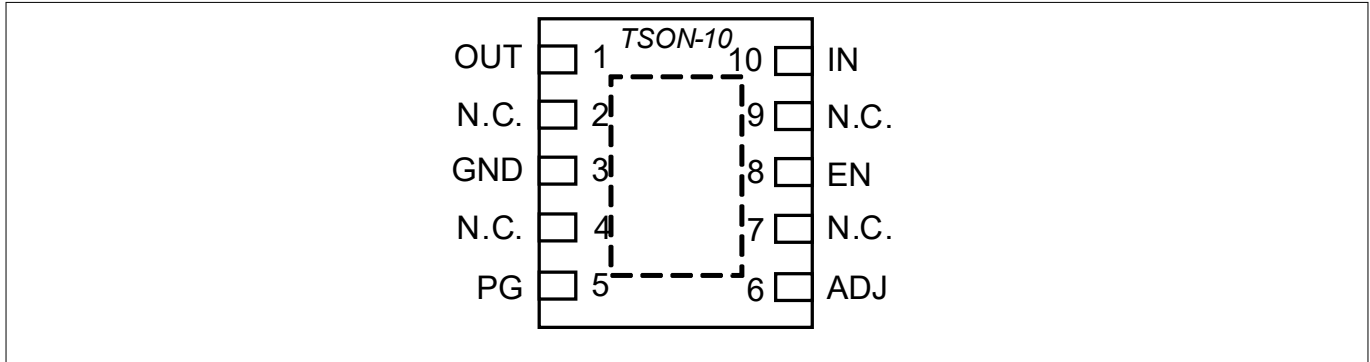

**Figure 1** Block diagram

**2 Pin configuration**

**2 Pin configuration**

**2.1 Pin assignment**



**Figure 2 Pin configuration**

**2.2 Pin definitions and functions**

Pin	Symbol	Function
1	OUT	Tracker output: 150 mA output current capability. Connect this pin to GND with a capacitor close to the pins, maintaining and ESR requirements given in <a href="#">Table 2</a> .
2	N.C.	Not connected
3	GND	Ground
4	N.C.	Not connected
5	PG	Power good: Open drain output. Connect this pin to a positive voltage rail via a pull-up resistor. "Low" signal indicates a fault condition of the tracker output.
6	ADJ	Adjust: Connect this pin to the reference voltage.
7	N.C.	Not connected
8	EN	Enable input: "High" signal enables the tracker. "Low" signal disables the tracker. If the enable function is not required, then connect EN to IN.
9	N.C.	Not connected
10	IN	Input: It is recommended to connect this pin to GND using a small ceramic capacitor close to the pins in order to compensate line influence.

## 2 Pin configuration

Pin	Symbol	Function
Pad	–	Exposed pad: Connect the exposed pad to GND. It is recommended to connect the exposed pad to a heat sink.

**3 General product characteristics**

**3 General product characteristics**

**3.1 Absolute maximum ratings**

**Table 1 Absolute maximum ratings<sup>1)</sup>**

$T_j = -40^\circ\text{C}$  to  $150^\circ\text{C}$ ; all voltages with respect to ground, positive current flowing into pin  
(unless otherwise specified)

Parameter	Symbol	Values			Unit	Note or condition	Number
		Min.	Typ.	Max.			
<b>Input IN</b>							
Voltage	$V_{IN}$	-16	-	45	V	-	P_3.1.1
<b>Enable EN</b>							
Voltage	$V_{EN}$	-16	-	45	V	-	P_3.1.2
<b>Adjust ADJ</b>							
Voltage	$V_{ADJ}$	-16	-	45	V	-	P_3.1.3
<b>Output OUT</b>							
Voltage	$V_{OUT}$	-5	-	45	V	-	P_3.1.4
<b>Input output voltage difference</b>							
Voltage	$V_{IN} - V_{OUT}$	-30	-	45	V	-	P_3.1.5
<b>Power good PG</b>							
Voltage	$V_{PG}$	-0.3	-	7	V	-	P_3.1.6
<b>Temperatures</b>							
Junction temperature	$T_j$	-40	-	150	$^\circ\text{C}$	-	P_3.1.7
Storage temperature	$T_{stg}$	-55	-	150	$^\circ\text{C}$	-	P_3.1.8
<b>ESD Susceptibility</b>							
ESD susceptibility to GND	$V_{ESD,HBM}$	-4	-	4	kV	<sup>2)</sup> Human Body Model (HBM)	P_3.1.9
ESD susceptibility to GND	$V_{ESD,CDM}$	-1	-	1	kV	<sup>3)</sup> Charged Device Model (CDM)	P_3.1.10
ESD susceptibility to GND	$V_{ESD,CDM}$	-1	-	1	kV	<sup>3)</sup> Charged Device Model (CDM) at corner pins	P_3.1.11

1) Not subject to production test, specified by design.

2) Human body model (HBM) robustness according to ANSI/ESDA/JEDEC JS-001 (1.5 k $\Omega$ , 100 pF).

3) Charged device model (CDM) robustness according to JEDEC JESD22-C101.



**3 General product characteristics**

**Notes:**

1. Stresses above the ones listed here may cause permanent damage to the device. Exposure to absolute maximum rating conditions for extended periods of time may affect device reliability.
2. Integrated protection functions are designed to prevent IC destruction under fault conditions described in the datasheet. Fault conditions are considered as outside the normal operating range. Protection functions are not designed for continuous repetitive operation.

**3.2 Functional range**

**Table 2 Functional range**

Parameter	Symbol	Values			Unit	Note or condition	Number
		Min.	Typ.	Max.			
Input voltage range	$V_{IN}$	4	–	45	V	–	P_3.2.1
Adjust input voltage range (voltage tracking range)	$V_{ADJ}$	2	–	14	V	–	P_3.2.2
Capacitance of output capacitor	$C_{OUT}$	1	–	–	$\mu\text{F}$	1) 2)	P_3.2.3
Equivalent series resistance of output capacitor	$ESR_{C_{OUT}}$	–	–	5	$\Omega$	2)	P_3.2.4
Junction temperature	$T_j$	-40	–	150	$^{\circ}\text{C}$	–	P_3.2.5

- 1) The minimum output capacitance requirement is applicable for a worst case capacitance tolerance of 30%.
- 2) Not subject to production test, specified by design.

**Note:** Within the functional range, the IC operates as described in the circuit description. The electrical characteristics are specified within the conditions given in the electrical characteristics table.

**3.3 Thermal resistance**

**Note:** This thermal data was generated in accordance with JEDEC JESD51 standards. For more information, go to [www.jedec.org](http://www.jedec.org).

**Table 3 Thermal resistance**

Parameter	Symbol	Values			Unit	Note or condition	Number
		Min.	Typ.	Max.			
Junction to case	$R_{thJC}$	–	17	–	K/W	1)	P_3.3.7
Junction to pin	$R_{thJP}$	–	96	–	K/W	–	P_3.3.8
Junction to ambient	$R_{thJA}$	–	67	–	K/W	2) 2s2p board	P_3.3.9
Junction to ambient	$R_{thJA}$	–	194	–	K/W	3) 1s0p board, footprint only	P_3.3.10
Junction to ambient	$R_{thJA}$	–	82	–	K/W	3) 1s0p board, 300 mm <sup>2</sup> heatsink area on PCB	P_3.3.11

**(table continues...)**

**3 General product characteristics**

**Table 3 (continued) Thermal resistance**

Parameter	Symbol	Values			Unit	Note or condition	Number
		Min.	Typ.	Max.			
Junction to ambient	$R_{thJA}$	–	68	–	K/W	<sup>3)</sup> 1s0p board, 600 mm <sup>2</sup> heatsink area on PCB	P_3.3.12

1) Not subject to production test, specified by design.

2) Specified  $R_{thJA}$  value is according to JEDEC JESD51-2,-5,-7 at natural convection on FR4 2s2p board; the product (chip and package) was simulated on a 76.2 × 114.3 × 1.5 mm<sup>3</sup> board with two inner copper layers (2 × 70 μm Cu, 2 × 35 μm Cu). Where applicable, a thermal via array next to the package contacted the first inner copper layer.

3) Specified  $R_{thJA}$  value is according to JEDEC JESD51-3 at natural convection on FR4 1s0p board; the product (chip and package) was simulated on a 76.2 × 114.3 × 1.5 mm<sup>3</sup> board with one copper layer (1 × 70 μm Cu).

**Note:** This thermal data was generated in accordance with JEDEC JESD51 standards. For more information visit [www.jedec.org](http://www.jedec.org).

## **4 Block description and electrical characteristics**

### **4.1 Functional description tracking regulator**

The regulator controls the output voltage  $V_{OUT}$  by comparing it to the voltage applied to the ADJ pin and driving a PNP pass transistor accordingly. The stability of the control loop depends on:

- The output capacitor  $C_{OUT}$
- Load current
- Chip temperature
- The poles and zeroes in the frequency response of the circuit consisting of the TLS115D0LD and the load

An input capacitor  $C_{IN}$  is strongly recommended for buffering the line influence.

To ensure stable operation, the output capacitor's capacitance and its equivalent series resistance *ESR* must fulfill the requirements in [Table 2](#). The output capacitor must be sized suitably to buffer load transients.

Connect each capacitor close to the pins.

The internal protection features are designed to protect the device itself as well as the application from destruction in case of catastrophic events. These safeguards contain:

- Output current limitation
- Reverse polarity protection
- Thermal shutdown

#### **Output current limitation**

In order to protect the pass element and the package from excessive power dissipation, the device limits the maximum output current at high input voltage.

#### **Reverse polarity protection**

The device allows a negative supply voltage. However, in reverse polarity condition several small currents flowing into the device increase the junction temperature. Thermal design must consider this effect, because in reverse polarity condition the overtemperature protection circuit does not operate.

#### **Thermal shutdown**

The overtemperature protection circuit is designed to prevent immediate destruction of the device in certain fault conditions (for example a permanent short circuit at output) by switching off the power stage. After the chip cools down, the regulator restarts. If the fault is not removed, then this leads to an oscillatory behavior of the output voltage. A junction temperature above 150°C is outside the maximum ratings and reduces the lifetime of the device.

**4 Block description and electrical characteristics**

**4.2 Electrical characteristics tracking regulator**

**Table 4 Electrical characteristics tracking regulator**

$V_{IN} = 13.5\text{ V}$ ;  $2.0\text{ V} \leq V_{ADJ} \leq 14\text{ V}$ ;  $V_{EN} \geq 2.0\text{ V}$ ;  $T_j = -40^\circ\text{C}$  to  $150^\circ\text{C}$ ; all voltages with respect to ground, positive current flowing into pin (unless otherwise specified).

Parameter	Symbol	Values			Unit	Note or condition	Number
		Min.	Typ.	Max.			
<b>Tracking output</b>							
Output voltage tracking accuracy	$\Delta V_{OUT}$	-5	-	5	mV	$\Delta V_{OUT} = V_{ADJ} - V_{OUT}$ ; $5.5\text{ V} \leq V_{IN} \leq 22\text{ V}$ ; $0.1\text{ mA} \leq I_{OUT} \leq 150\text{ mA}$ ; $2\text{ V} \leq V_{ADJ} \leq V_{IN} - 1\text{ V}$	P_4.1.1
Output voltage tracking accuracy	$\Delta V_{OUT}$	-5	-	5	mV	$\Delta V_{OUT} = V_{ADJ} - V_{OUT}$ ; $5.5\text{ V} \leq V_{IN} \leq 32\text{ V}$ ; $0.1\text{ mA} \leq I_{OUT} \leq 70\text{ mA}$ ; $2\text{ V} \leq V_{ADJ} \leq V_{IN} - 1\text{ V}$	P_4.1.2
Load regulation steady-state	$\Delta V_{OUT,load}$	-4	-0.1	-	mV	$I_{OUT} = 0.1\text{ mA}$ to $150\text{ mA}$ ; $V_{ADJ} = 5\text{ V}$	P_4.1.3
Line regulation steady-state	$\Delta V_{OUT,line}$	-	0.1	4	mV	$V_{IN} = 5.5\text{ V}$ to $32\text{ V}$ ; $I_{OUT} = 10\text{ mA}$ ; $V_{ADJ} = 5\text{ V}$	P_4.1.4
Power supply ripple rejection	PSRR	-	85	-	dB	<sup>1)</sup> $f_{ripple} = 100\text{ Hz}$ ; $V_{ripple} = 1\text{ V}_{pp}$ ; $I_{OUT} = 10\text{ mA}$ ; $C_{OUT} = 10\text{ }\mu\text{F}$ , ceramic type	P_4.1.5
Output current limitation	$I_{OUT,max}$	151	350	500	mA	$V_{OUT} = V_{ADJ} - 0.1\text{ V}$ ; $V_{ADJ} = 5\text{ V}$	P_4.1.6
Reverse current	$I_{OUT,rev}$	-3.5	-1.7	-	mA	$V_{IN} = 0\text{ V}$ ; $V_{OUT} = 16\text{ V}$ ; $V_{ADJ} = 5\text{ V}$	P_4.1.9
Reverse current at negative input voltage	$I_{IN,rev}$	-4	-2	-	mA	$V_{IN} = -16\text{ V}$ ; $V_{OUT} = 0\text{ V}$ ; $V_{ADJ} = 5\text{ V}$	P_4.1.10
Dropout voltage	$V_{dr}$	-	250	500	mV	<sup>2)</sup> $V_{dr} = V_{IN} - V_{OUT}$ ; $I_{OUT} = 150\text{ mA}$ ; $V_{ADJ} = 5\text{ V}$	P_4.1.11

**(table continues...)**

**4 Block description and electrical characteristics**

**Table 4 (continued) Electrical characteristics tracking regulator**

$V_{IN} = 13.5\text{ V}$ ;  $2.0\text{ V} \leq V_{ADJ} \leq 14\text{ V}$ ;  $V_{EN} \geq 2.0\text{ V}$ ;  $T_j = -40^\circ\text{C}$  to  $150^\circ\text{C}$ ; all voltages with respect to ground, positive current flowing into pin (unless otherwise specified).

Parameter	Symbol	Values			Unit	Note or condition	Number
		Min.	Typ.	Max.			
<b>Overtemperature protection</b>							
Overtemperature shutdown threshold	$T_{j,sd}$	–	175	–	$^\circ\text{C}$	$T_j$ increasing due to power dissipation generated by the device	P_4.1.15
Overtemperature shutdown threshold hysteresis	$\Delta T_{j,sdh}$	–	15	–	K	–	P_4.1.16

1) Not subject to production test, specified by design.

2) Measured when the output voltage  $V_{OUT}$  has dropped 100 mV from the nominal value obtained at  $V_{IN} = 13.5\text{ V}$ .

**4 Block description and electrical characteristics**

**4.3 Typical performance characteristics tracking regulator**

Tracking accuracy  $\Delta V_{OUT}$  versus junction temperature  $T_j$

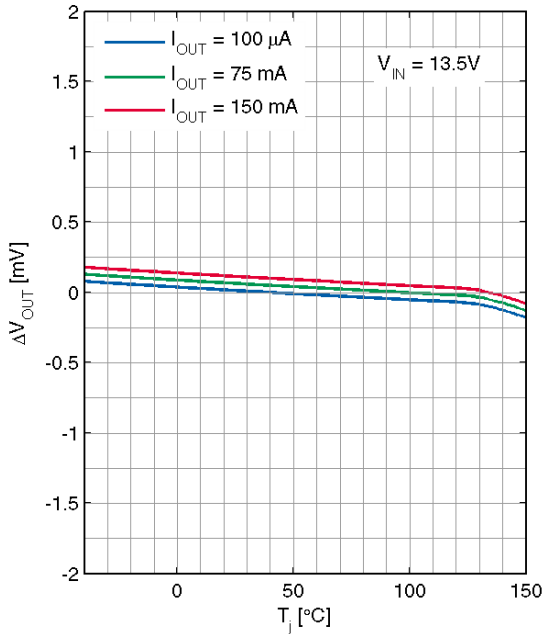

Output current limitation  $I_{OUT,max}$  versus input voltage  $V_{IN}$

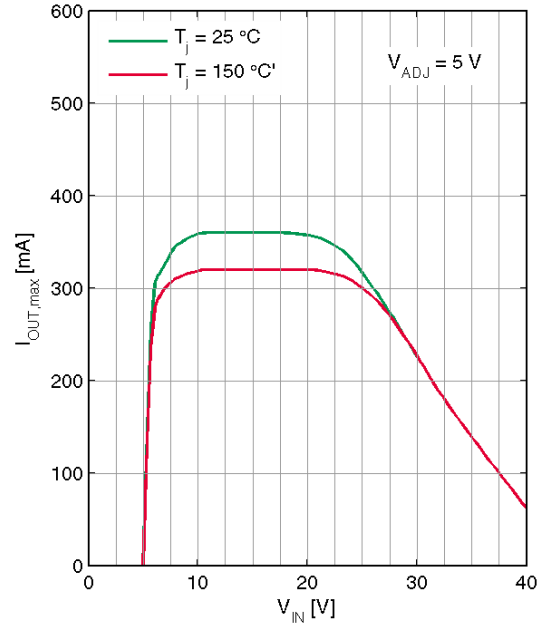

Output voltage  $V_{OUT}$  versus adjust voltage  $V_{ADJ}$

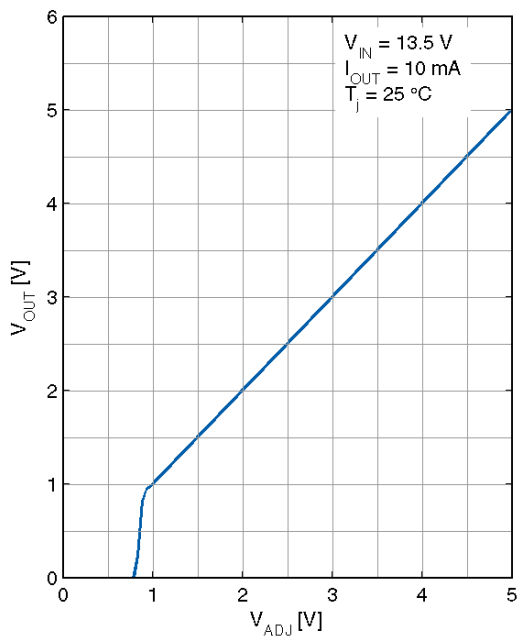

Output voltage  $V_{OUT}$  versus input voltage  $V_{IN}$

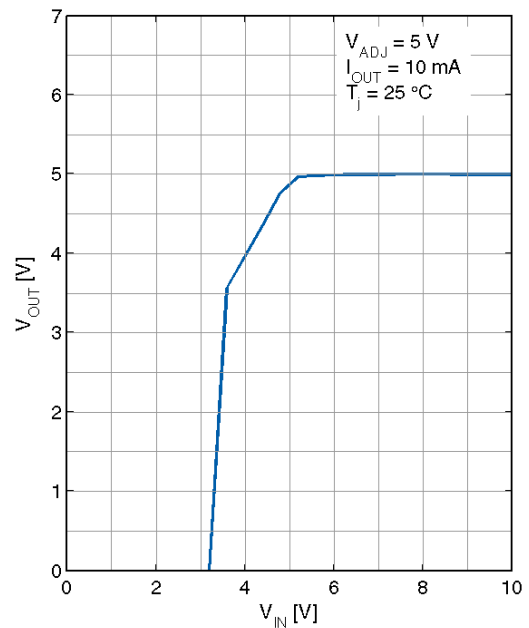

**4 Block description and electrical characteristics**

Load regulation  $\Delta V_{OUT,load}$  versus output current  $I_{OUT}$

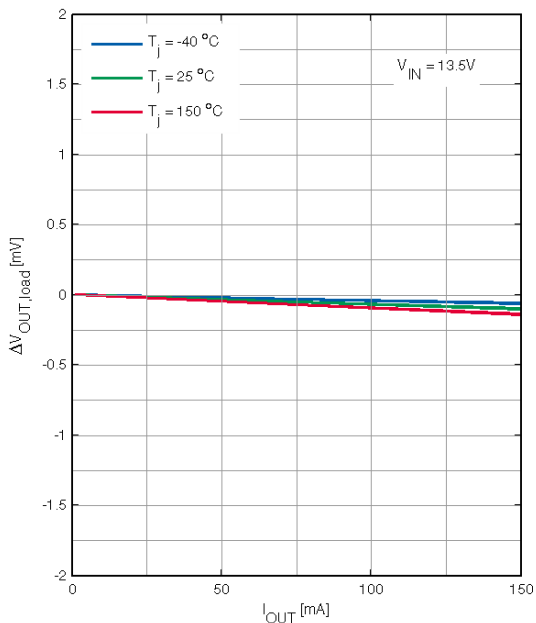

Line regulation  $\Delta V_{OUT,line}$  versus input voltage  $V_{IN}$

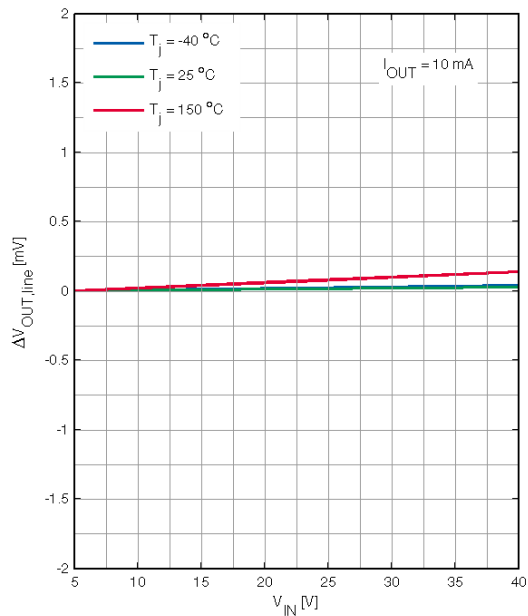

Dropout voltage  $V_{dr}$  versus junction temperature  $T_j$

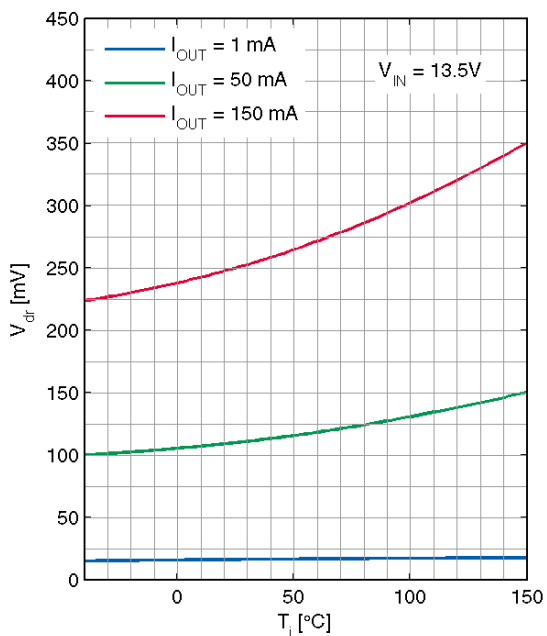

Dropout voltage  $V_{dr}$  versus output current  $I_{OUT}$

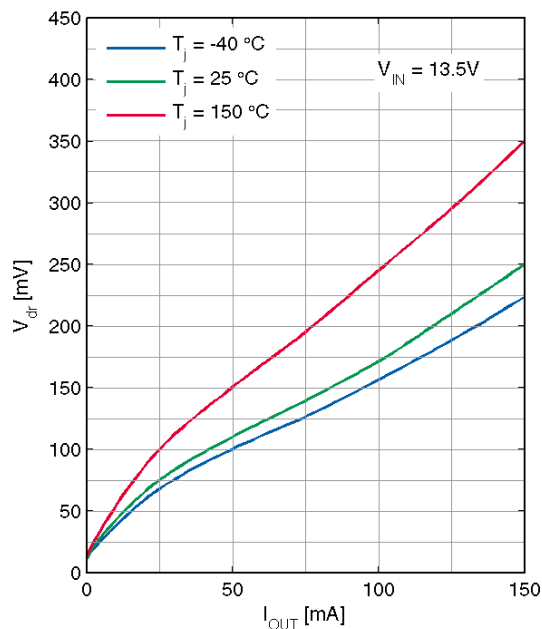

**4 Block description and electrical characteristics**

Reverse current  $I_{IN,rev}$  versus input voltage  $V_{IN}$

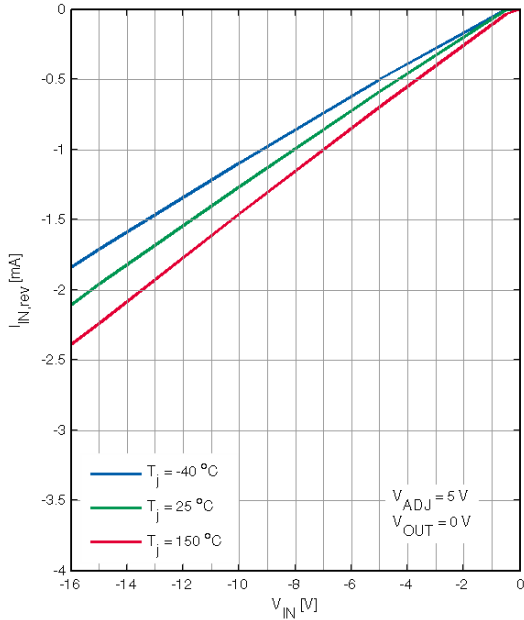

Reverse current  $I_{OUT,rev}$  versus output voltage  $V_{OUT}$

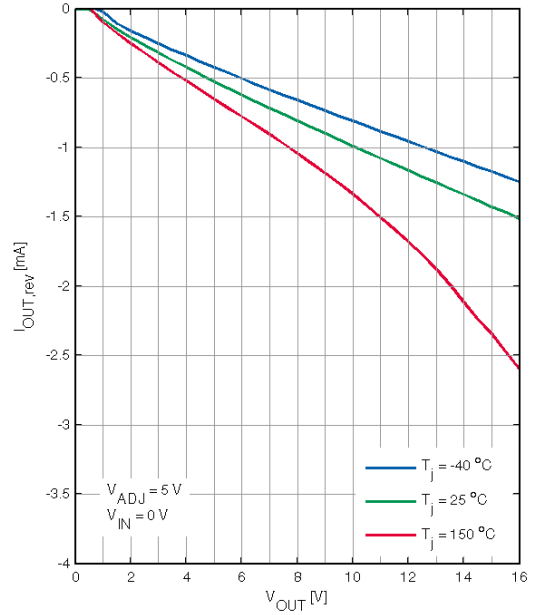

Power supply ripple rejection  $PSRR$  versus ripple frequency  $f_r$

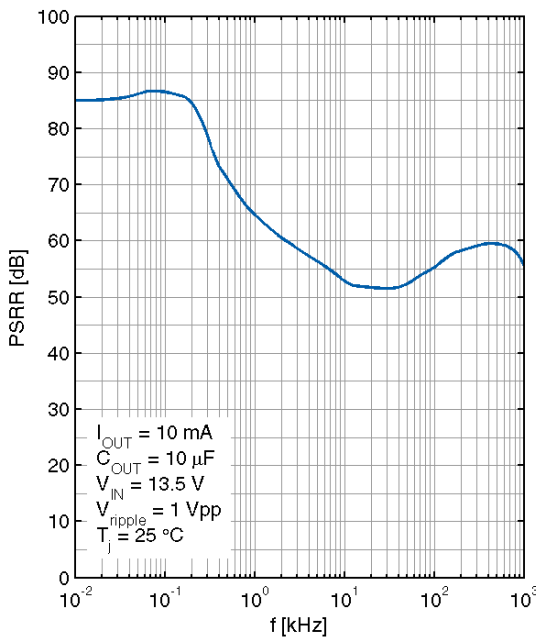

Output capacitor  $ESR_{C_{OUT}}$  versus output current  $I_{OUT}$

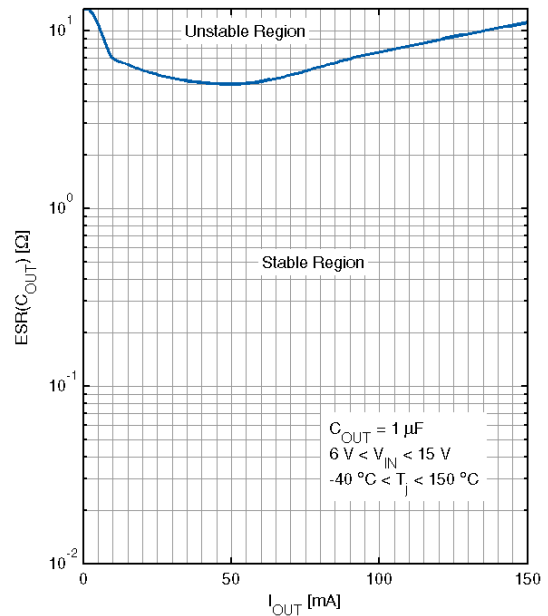



**4 Block description and electrical characteristics**

**4.4 Electrical characteristics current consumption**

**Table 5 Electrical characteristics current consumption**

$V_{IN} = 13.5\text{ V}$ ;  $2.0\text{ V} \leq V_{ADJ} \leq 14\text{ V}$ ;  $V_{EN} \geq 2.0\text{ V}$ ;  $T_j = -40^\circ\text{C}$  to  $150^\circ\text{C}$ ; all voltages with respect to ground, positive current flowing into pin (unless otherwise specified).

Parameter	Symbol	Values			Unit	Note or condition	Number
		Min.	Typ.	Max.			
Current consumption stand-by mode	$I_{q,off}$	–	0.1	5	$\mu\text{A}$	$I_{q,off} = I_{IN}$ ; $V_{EN} \leq 0.4\text{ V}$ ; $T_j \leq 125^\circ\text{C}$	P_4.3.1
Current consumption	$I_q$	–	55	90	$\mu\text{A}$	$I_q = I_{IN} - I_{OUT}$ ; $I_{OUT} \leq 0.1\text{ mA}$ ; $V_{ADJ} = 5\text{ V}$ ; $T_j \leq 125^\circ\text{C}$	P_4.3.2
Current consumption	$I_q$	–	7	14	$\text{mA}$	$I_q = I_{IN} - I_{OUT}$ ; $I_{OUT} \leq 150\text{ mA}$ ; $V_{ADJ} = 5\text{ V}$	P_4.3.3

**4 Block description and electrical characteristics**

**4.5 Typical performance characteristics current consumption**

Current consumption  $I_q$  versus output current  $I_{OUT}$

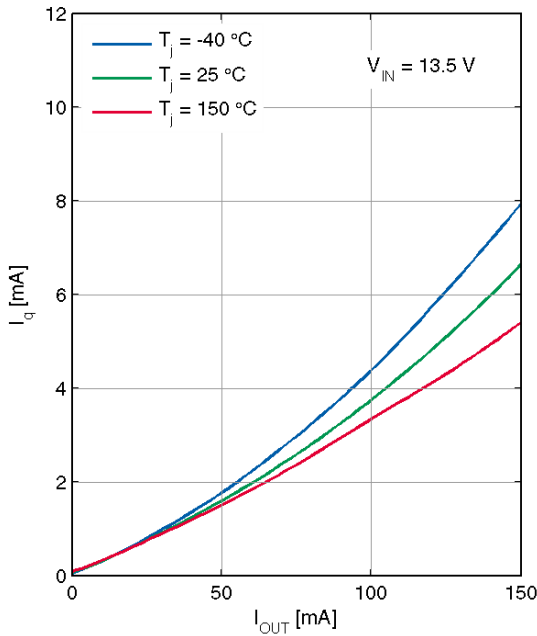

Current consumption  $I_q$  versus input voltage  $V_{IN}$

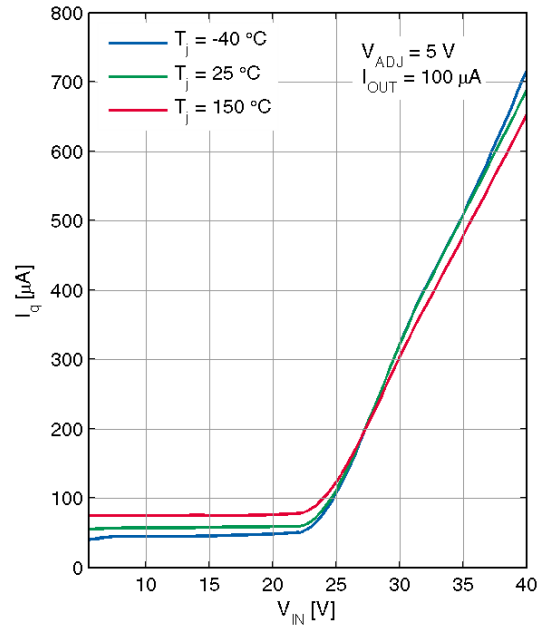

Current consumption  $I_q$  versus junction temperature  $T_j$

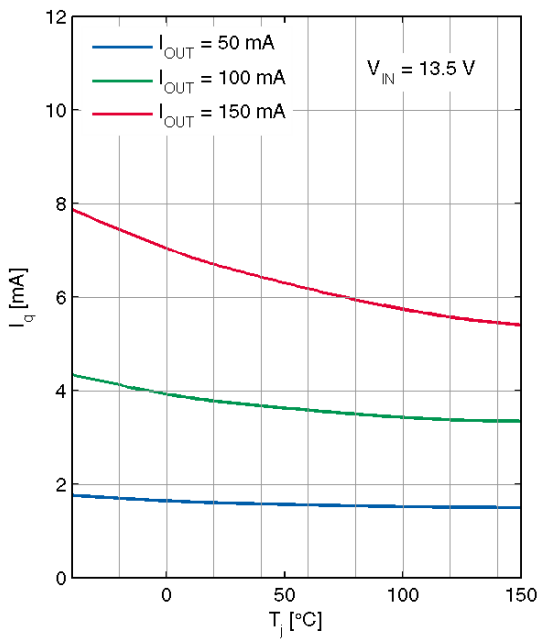

Current consumption  $I_q$  versus junction temperature  $T_j$  ( $I_{OUT}$  low)

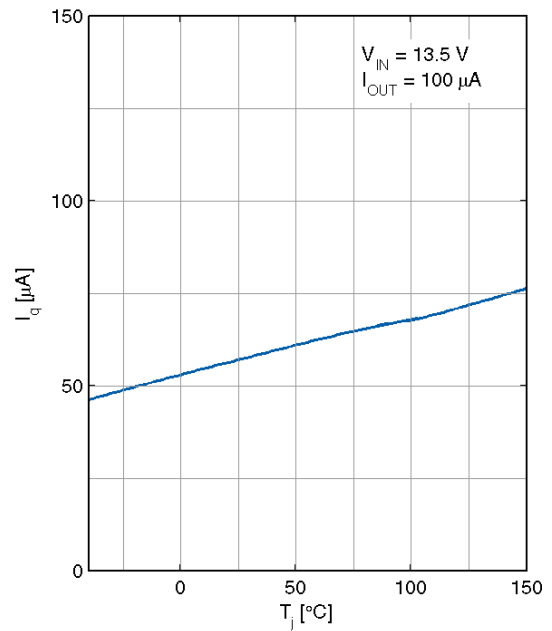

**4 Block description and electrical characteristics**

Current consumption in off-mode  $I_{q,off}$  versus  
junction temperature  $T_j$

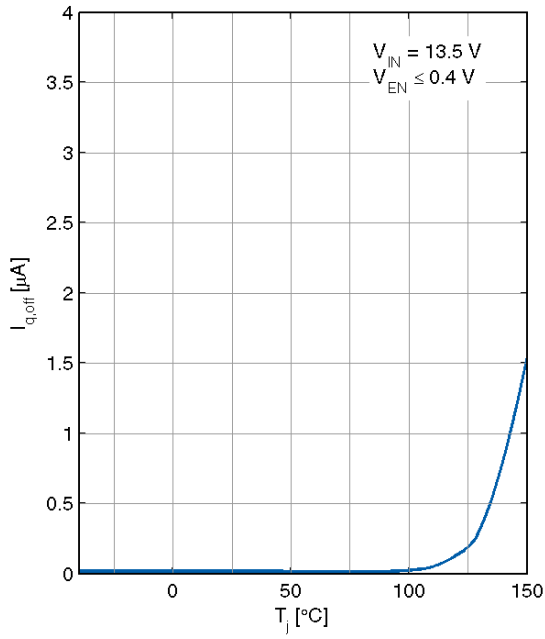

**4 Block description and electrical characteristics**

**4.6 Functional description enable input**

On a "low" signal at the enable input EN the device switches to standby mode in order to minimize the quiescent current.

If the EN pin is not connected, then the "low" level from the internal pull-down resistor switches off the regulator.

**4.7 Electrical characteristics enable input**

**Table 6 Electrical characteristics enable input**

$V_{IN} = 13.5\text{ V}$ ;  $2.0\text{ V} \leq V_{ADJ} \leq 14\text{ V}$ ;  $T_j = -40^\circ\text{C}$  to  $150^\circ\text{C}$ ; all voltages with respect to ground, positive current flowing into pin (unless otherwise specified).

Parameter	Symbol	Values			Unit	Note or condition	Number
		Min.	Typ.	Max.			
Enable off voltage range	$V_{EN,off}$	–	–	0.8	V	$V_{OUT} = 0\text{ V}$ ; $I_{OUT} \leq 5\ \mu\text{A}$ ; $T_j \leq 125^\circ\text{C}$	P_4.5.1
Enable on voltage range	$V_{EN,on}$	2	–	–	V	$V_{OUT}$ settled	P_4.5.2
Enable input current	$I_{EN}$	–	2	4	$\mu\text{A}$	$V_{EN} = 5\text{ V}$	P_4.5.3

**4 Block description and electrical characteristics**

**4.8 Typical performance characteristics enable input**

Enable input current  $I_{EN}$  versus  
enable input voltage  $V_{EN}$

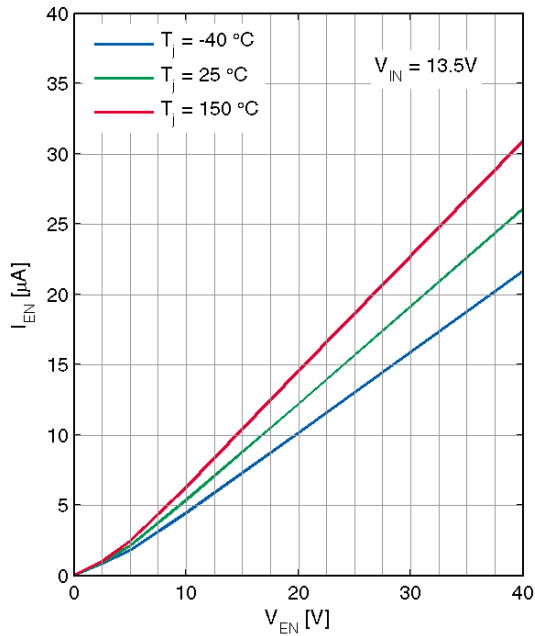

## 4 Block description and electrical characteristics

### 4.9 Functional description adjust input

The adjust input must be connected to the reference voltage that the device tracks.

### 4.10 Electrical characteristics adjust input

**Table 7 Electrical characteristics adjust input**

$V_{IN} = 13.5\text{ V}$ ;  $2.0\text{ V} \leq V_{ADJ} \leq 14\text{ V}$ ;  $V_{EN} \geq 2.0\text{ V}$ ;  $T_j = -40^\circ\text{C}$  to  $150^\circ\text{C}$ ; all voltages with respect to ground, positive current flowing into pin (unless otherwise specified).

Parameter	Symbol	Values			Unit	Note or condition	Number
		Min.	Typ.	Max.			
Adjust input current	$I_{ADJ}$	–	0.03	1	$\mu\text{A}$	$V_{ADJ} = 5\text{ V}$	P_4.7.1

**4 Block description and electrical characteristics**

**4.11 Typical performance characteristics adjust input**

Adjust input current  $I_{ADJ}$  versus  
 adjust input voltage  $V_{ADJ}$

Adjust input current  $I_{ADJ}$  versus  
 junction temperature  $T_j$

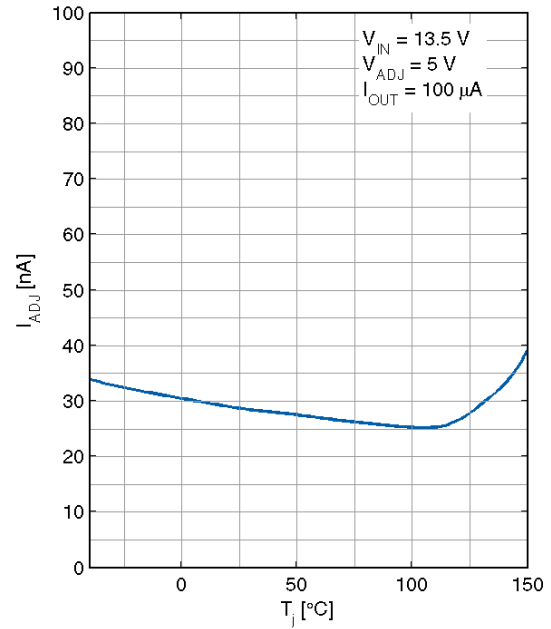
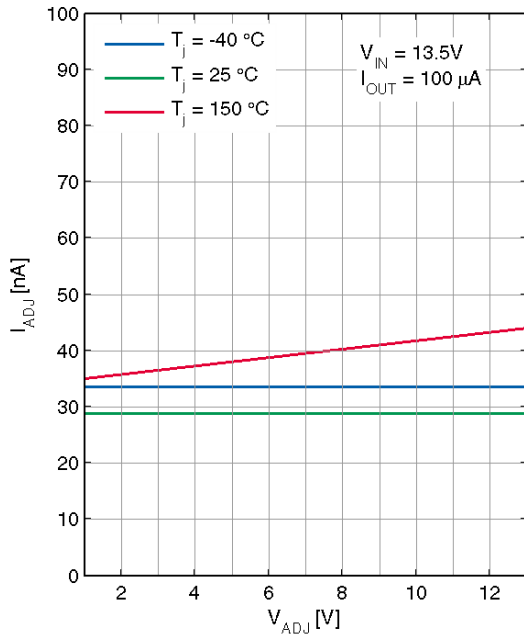

## 4 Block description and electrical characteristics

### 4.12 Functional description power good output

The power good output PG indicates an overvoltage or undervoltage condition at the tracker output. For this the device compares the output voltage  $V_{OUT}$  to the reference voltage  $V_{ADJ}$ . The device indicates variations of the output voltage beyond the power good switching thresholds by a "low" signal at the power good output PG. Transients shorter than the power good reaction time  $t_{PG,r}$  do not trigger the power good output.

### 4.13 Electrical characteristics power good output

The power good output PG is an open drain output that requires a pull-up resistor to a positive voltage rail. The pull-up voltage must maintain the absolute maximum ratings of power good PG, see [Absolute maximum ratings](#).

**Table 8 Electrical characteristics power good output**

$V_{IN} = 13.5\text{ V}$ ;  $2.0\text{ V} \leq V_{ADJ} \leq 14\text{ V}$ ;  $V_{EN} \geq 2.0\text{ V}$ ;  $T_j = -40^\circ\text{C}$  to  $150^\circ\text{C}$ ; all voltages with respect to ground, positive current flowing into pin (unless otherwise specified).

Parameter	Symbol	Values			Unit	Note or condition	Number
		Min.	Typ.	Max.			
Power good switching threshold, undervoltage	$V_{OUT,UV}$	$V_{ADJ} - 120$	$V_{ADJ} - 70$	$V_{ADJ} - 50$	mV	$V_{OUT}$ decreasing; $V_{IN} \geq V_{ADJ} + 150\text{ mV}$	P_4.9.1
Power good switching threshold, overvoltage	$V_{OUT,OV}$	$V_{ADJ} + 50$	$V_{ADJ} + 70$	$V_{ADJ} + 120$	mV	$V_{OUT}$ increasing; $V_{IN} \geq V_{ADJ} + 150\text{ mV}$	P_4.9.2
Power good reaction time	$t_{PG,r}$	10	15	30	$\mu\text{s}$	–	P_4.9.3
Power good output "low" voltage	$V_{PG,low}$	–	0.2	0.4	V	$V_{IN} \geq 4\text{ V}$ ; $I_{PG,ext} \leq 1.8\text{ mA}$	P_4.9.4
Power good output external input current	$I_{PG,ext}$	–	–	1.8	mA	$V_{PG} \leq 0.4\text{ V}$	P_4.9.5
Power good output leakage current	$I_{PG,leak}$	–	0	2	$\mu\text{A}$	$V_{OUT} = V_{ADJ}$ ; $V_{PG} = 5\text{ V}$	P_4.9.6



**5 Application information**

**5 Application information**

**Note:** *The following information is given as an example for the implementation of the device only and shall not be regarded as a description or warranty of a certain functionality, condition or quality of the device.*

**5.1 Application diagram**

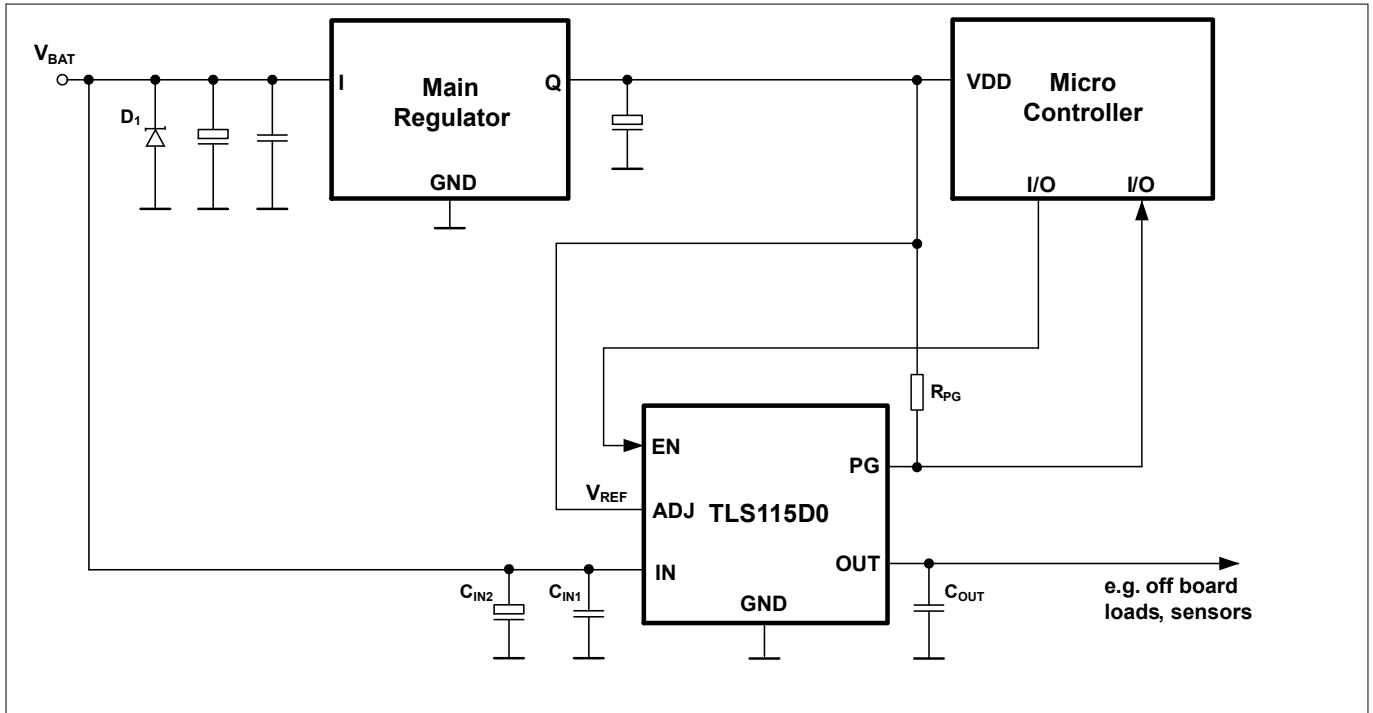

**Figure 3 Application diagram**

**Note:** *This figure is a simplified example of an application circuit. The function must be verified in the application.*

**5.2 Selection of external components**

**5.2.1 Input pin**

Figure 3 shows the typical input circuitry for a voltage tracking regulator. The following external components at the input are recommended in case of possible external disturbance.

**Ceramic capacitor**

A ceramic capacitor  $C_{IN1}$  (100 nF to 470 nF) at the input filters high frequency disturbance imposed by the line, such as ISO pulses 3a/b. Place  $C_{IN1}$  as close as possible to the input pin of the voltage tracking regulator on the PCB.

**Aluminum electrolytic capacitor**

An aluminum electrolytic capacitor  $C_{IN2}$  (10  $\mu$ F to 470  $\mu$ F) at the input smoothens high energy pulses, such as ISO pulse 2a. Place  $C_{IN2}$  close to the input pin of the voltage tracking regulator on the PCB.

## 5 Application information

### Overvoltage suppression diode

A suitably sized diode  $D_1$  suppresses high voltage beyond the maximum ratings of the circuit components and protects the device from damage due to overvoltage.

### 5.2.2 Output pin

An output capacitor  $C_{OUT}$  is necessary for the stability of the voltage tracking regulator, see Functional range. The typical performance graph [Output capacitor ESR \$C\_{OUT}\$  versus output current  \$I\_{OUT}\$](#)  shows the stable operation range of the device.

In an automotive environment, ceramic capacitors with X5R or X7R dielectrics are recommended.

Place  $C_{OUT}$  on the same side of the PCB as the device and as close as possible to both the OUTpin and the GND pin.

In case of rapid transients of input voltage or load current,  $C_{OUT}$  must be dimensioned accordingly to ensure the output stability in the application.

### 5.2.3 Adjust pin

[Figure 3](#) shows a typical adjust circuitry for a voltage tracking regulator. Typically the adjust pin is connected to a fixed voltage reference that the regulator tracks. In the example of the application diagram ADJ is connected to the supply voltage of a microcontroller. Alternatively, the voltage reference can also be adjusted by a voltage divider.

### 5.2.4 Power good pin

The power good output is an open drain output, which requires a pull-up resistor to a positive voltage rail. The pull-up voltage at PG must maintain the values specified in [Absolute maximum ratings](#). The example in [Figure 3](#) uses the supply voltage VDD of a microcontroller as pull-up.

To limit the external input current according to the requirements in [Electrical characteristics power good output](#), the pull-up resistor must be sized depending on the pull-up voltage.

## 5.3 Thermal considerations

From the known input voltage, the output voltage and the load profile of the application, the total power dissipation can be calculated:

$$P_D = (V_{IN} - V_{OUT}) \times I_{OUT} + V_{IN} \times I_q$$

### Equation 1

with

- $P_D$ : continuous power dissipation
- $V_{IN}$ : input voltage
- $V_{OUT}$ : output voltage
- $I_{OUT}$ : output current
- $I_q$ : quiescent current

The maximum acceptable thermal resistance  $R_{thJA}$  can then be calculated:

## 5 Application information

$$R_{\text{thJA, max}} = \frac{T_{j, \text{max}} - T_a}{P_D}$$

### Equation 2

with

- $T_{j, \text{max}}$ : maximum allowed junction temperature
- $T_a$ : ambient temperature

Based on the above calculation the proper PCB type and the necessary heat sink area can be determined with reference to the specification in [Thermal resistance](#).

### Example

Application conditions:

$$V_{\text{IN}} = 13.5 \text{ V}$$

$$V_{\text{OUT}} = V_{\text{ADJ}} = 5 \text{ V}$$

$$I_{\text{OUT}} = 100 \text{ mA}$$

$$T_a = 75^\circ\text{C}$$

Calculation of  $R_{\text{thJA, max}}$ :

$$P_D = (V_{\text{IN}} - V_{\text{OUT}}) \times I_{\text{OUT}} + V_{\text{IN}} \times I_q$$

$$= (13.5\text{V} - 5\text{V}) \times 100 \text{ mA} + 13.5 \text{ V} \times 3.5 \text{ mA}$$

$$= 0.897 \text{ W}$$

$$R_{\text{thJA, max}} = (T_{j, \text{max}} - T_a) / P_D$$

$$= (150^\circ\text{C} - 75^\circ\text{C}) / 0.897 \text{ W}$$

$$= 83.6 \text{ K/W}$$

As a result, the PCB design must ensure a thermal resistance  $R_{\text{thJA}}$  lower than 83.6 K/W. According to [Thermal resistance](#), at least 300 mm<sup>2</sup> heat sink area is required on the FR4 1s0p PCB, or the FR4 2s2p board can be used.

## 5.4 Further application information

- For further information you may contact <http://www.infineon.com/>

**6 Package information**

**6 Package information**

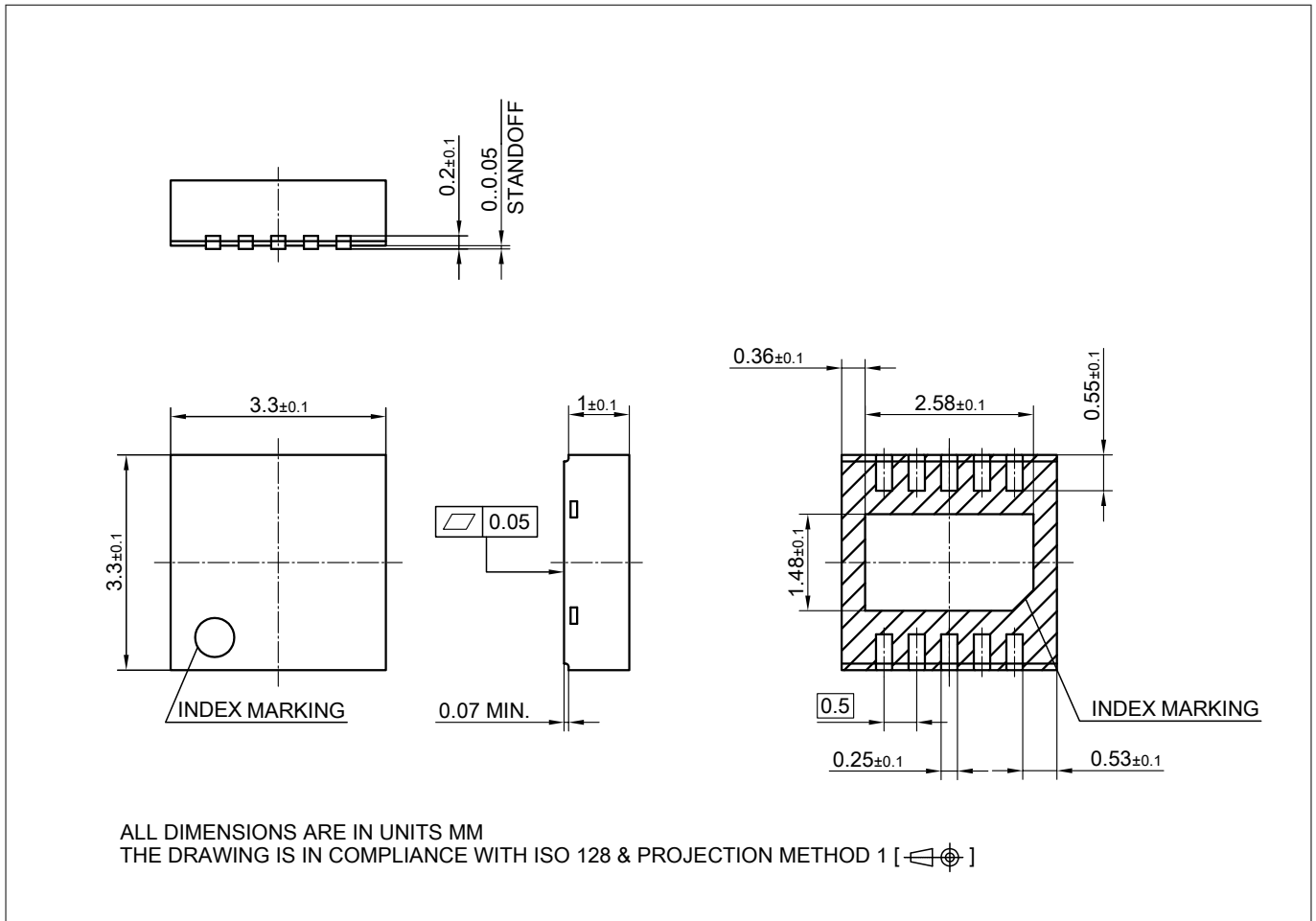

**Figure 4 PG-TSON-10**

**Green Product (RoHS compliant)**

To meet the world-wide customer requirements for environmentally friendly products and to be compliant with government regulations the device is available as a Green Product. Green Products are RoHS compliant (Pb-free finish on leads and suitable for Pb-free soldering according to IPC/JEDEC J-STD-020).

**Information on alternative packages**

Please visit [www.infineon.com/packages](http://www.infineon.com/packages).

---

**Revision history**

## **Revision history**

<b>Revision</b>	<b>Date</b>	<b>Changes</b>
1.13	2024-03-20	Datasheet updated: <ul style="list-style-type: none"><li>• Marking corrected</li></ul>
1.12	2022-11-10	Datasheet updated: <ul style="list-style-type: none"><li>• Editorial changes</li></ul>
1.11	2021-05-28	Datasheet updated: <ul style="list-style-type: none"><li>• Editorial changes</li></ul>
1.1	2020-03-19	Datasheet updated: <ul style="list-style-type: none"><li>• P_3.1.5 maximum value for input output voltage difference added</li><li>• Editorial changes</li></ul>
1.0	2016-10-13	Datasheet created

## Trademarks

All referenced product or service names and trademarks are the property of their respective owners.

**Edition 2024-03-20**

**Published by**

**Infineon Technologies AG**

**81726 Munich, Germany**

**© 2024 Infineon Technologies AG**

**All Rights Reserved.**

**Do you have a question about any aspect of this document?**

**Email: [erratum@infineon.com](mailto:erratum@infineon.com)**

**Document reference**

**IFX-qav1636994996564**

**Z8F70491089**

## Important notice

The information given in this document shall in no event be regarded as a guarantee of conditions or characteristics ("Beschaffheitsgarantie").

With respect to any examples, hints or any typical values stated herein and/or any information regarding the application of the product, Infineon Technologies hereby disclaims any and all warranties and liabilities of any kind, including without limitation warranties of non-infringement of intellectual property rights of any third party.

In addition, any information given in this document is subject to customer's compliance with its obligations stated in this document and any applicable legal requirements, norms and standards concerning customer's products and any use of the product of Infineon Technologies in customer's applications.

The data contained in this document is exclusively intended for technically trained staff. It is the responsibility of customer's technical departments to evaluate the suitability of the product for the intended application and the completeness of the product information given in this document with respect to such application.

## Warnings

Due to technical requirements products may contain dangerous substances. For information on the types in question please contact your nearest Infineon Technologies office.

Except as otherwise explicitly approved by Infineon Technologies in a written document signed by authorized representatives of Infineon Technologies, Infineon Technologies' products may not be used in any applications where a failure of the product or any consequences of the use thereof can reasonably be expected to result in personal injury.