



TELUX™
TLWR992.
Vishay Semiconductors

Description

The TELUX™ series is a clear, non diffused LED for applications where supreme luminous flux is required. It is designed in an industry standard 7.62 mm square package utilizing highly developed with super bright, AllnGaP, OMA technology.

The supreme heat dissipation of TELUX™ allows applications at high ambient temperatures.

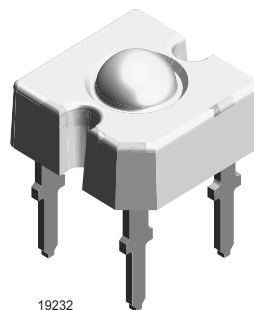
All packing units are binned for luminous flux, forward voltage and color to achieve the most homogenous light appearance in application.



19232



SAE and ECE color requirements for automobile application are available for color red.

ESD resistivity 2kV (HBM) according to MIL STD 883D, method 3015.7.

Features

- Utilizing one of the world's brightest (AS) AllnGaP technologies (OMA)
- High luminous flux
- Supreme heat dissipation: R_{thJP} is 90 K/W
- High operating temperature:
 $T_{amb} = -40$ to $+110$ °C
- Meets SAE and ECE color requirements for the automobile industry for color red
- Packed in tubes for automatic insertion
- Luminous flux, forward voltage and color categorized for each tube
- Small mechanical tolerances allow precise usage of external reflectors or lightguides
- Lead-free device

Applications

- Exterior lighting
- Tail-, Stop - and Turn Signals of motor vehicles
- Replaces small incandescent lamps
- Traffic signals and signs

Parts Table

Part	Color, Luminous Intensity	Angle of Half Intensity ($\pm\phi$)	Technology
TLWR9920	Red, $\phi_V > 3000$ mlm	45 °	AllnGaP on GaAs
TLWR9921	Red, $\phi_V > 3500$ mlm	45 °	AllnGaP on GaAs
TLWR9922	Red, $\phi_V > 4000$ mlm	45 °	AllnGaP on GaAs

TLWR992.

**Vishay Semiconductors**

Absolute Maximum Ratings

 $T_{amb} = 25\text{ }^{\circ}\text{C}$, unless otherwise specified**TLW.992.**

Parameter	Test condition	Symbol	Value	Unit
Reverse voltage	$I_R = 100\text{ }\mu\text{A}$	V_R	10	V
DC Forward current	$T_{amb} \leq 85\text{ }^{\circ}\text{C}$	I_F	70	mA
Surge forward current	$t_p \leq 10\text{ }\mu\text{s}$	I_{FSM}	0.1	A
Power dissipation	$T_{amb} \leq 85\text{ }^{\circ}\text{C}$	P_V	190	mW
Junction temperature		T_j	125	$^{\circ}\text{C}$
Operating temperature range		T_{amb}	- 40 to + 110	$^{\circ}\text{C}$
Storage temperature range		T_{stg}	- 55 to + 110	$^{\circ}\text{C}$
Soldering temperature	$t \leq 5\text{ s}$, 1.5 mm from body preheat temperature 100 $^{\circ}\text{C}$ / 30 sec.	T_{sd}	260	$^{\circ}\text{C}$
Thermal resistance junction/ ambient	with cathode heatsink of 70 mm ²	R_{thJA}	200	K/W

Optical and Electrical Characteristics

 $T_{amb} = 25\text{ }^{\circ}\text{C}$, unless otherwise specified

Red

TLW.992.

Parameter	Test condition	Part	Symbol	Min	Typ.	Max	Unit
Total flux	$I_F = 70\text{ mA}$, $R_{thJA} = 200\text{ }^{\circ}\text{K/W}$	TLWR9920	ϕ_V	3000	3700		mlm
		TLWR9921	ϕ_V	3500	4200		mlm
		TLWR9922	ϕ_V	4000	5000		mlm
Luminous intensity/Total flux	$I_F = 70\text{ mA}$, $R_{thJA} = 200\text{ }^{\circ}\text{K/W}$		I_V/ϕ_V		0.7		mcd/ mlm
Dominant wavelength	$I_F = 70\text{ mA}$, $R_{thJA} = 200\text{ }^{\circ}\text{K/W}$		λ_d	611	615	634	nm
Peak wavelength	$I_F = 70\text{ mA}$, $R_{thJA} = 200\text{ }^{\circ}\text{K/W}$		λ_p		624		nm
Angle of half intensity	$I_F = 70\text{ mA}$, $R_{thJA} = 200\text{ }^{\circ}\text{K/W}$		φ		± 45		deg
Total included angle	90 % of Total Flux Captured		$\varphi_{0.9V}$		100		deg
Forward voltage	$I_F = 70\text{ mA}$, $R_{thJA} = 200\text{ }^{\circ}\text{K/W}$		V_F	1.83	2.5	3.03	V
Reverse voltage	$I_R = 100\text{ }\mu\text{A}$		V_R	10	20		V
Temperature coefficient $< \lambda_d$	$I_F = 70\text{ mA}$		$TC\lambda_d$		17		nm/K
Temperature coefficient V_F	$I_F = 70\text{ mA}$, $T > - 25\text{ }^{\circ}\text{C}$		TCV_F		- 2.9		mV/K

Forward Voltage Classification

Group	Forward Voltage (V)	
	min	max
Y	1.83	2.07
Z	1.95	2.19
0	2.07	2.31
1	2.19	2.43
2	2.31	2.55
3	2.43	2.67
4	2.55	2.79
5	2.67	2.91
6	2.79	3.03



Color Classification

Group	Dominant Wavelength (nm)	
	min	max
1	611	618
2	614	622
3	616	624

Luminous Flux Classification

Group	Luminous Intensity (mIm)	
	min	max
F	3000	4200
G	3500	4800
H	4000	6100
I	5000	7300
K	6000	9700

Typical Characteristics (T_{amb} = 25 °C unless otherwise specified)

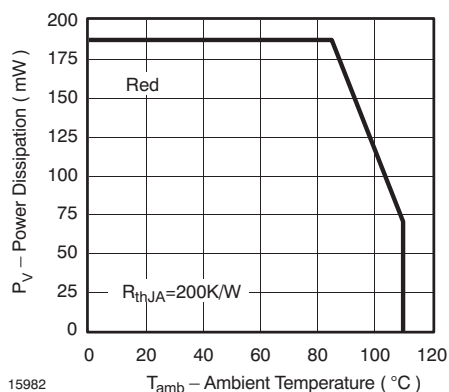

Figure 1. Power Dissipation vs. Ambient Temperature

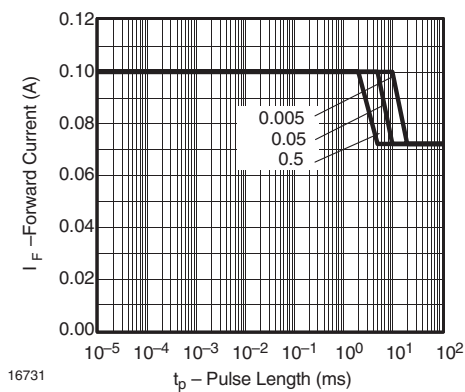

Figure 3. Forward Current vs. Pulse Length

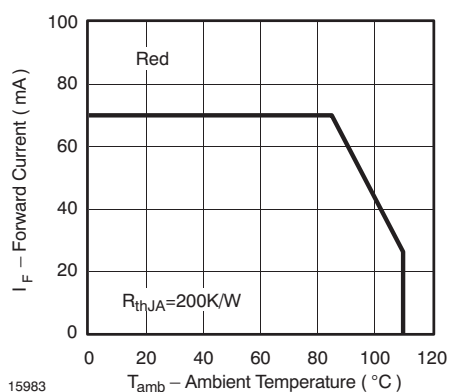

Figure 2. Forward Current vs. Ambient Temperature

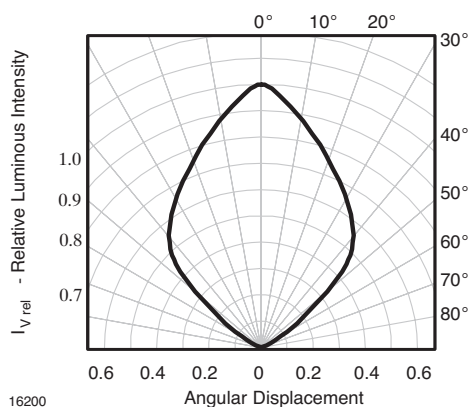

Figure 4. Rel. Luminous Intensity vs. Angular Displacement

TLWR992.

Vishay Semiconductors

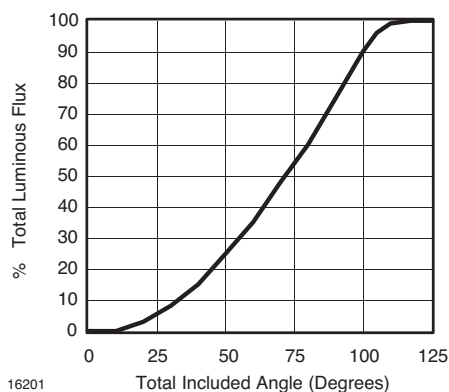

Figure 5. Percentage Total Luminous Flux vs. Total Included Angle for 90° emission angle

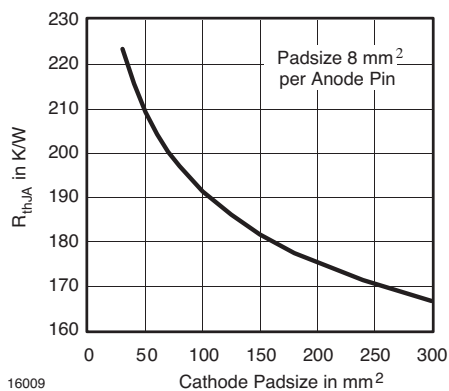
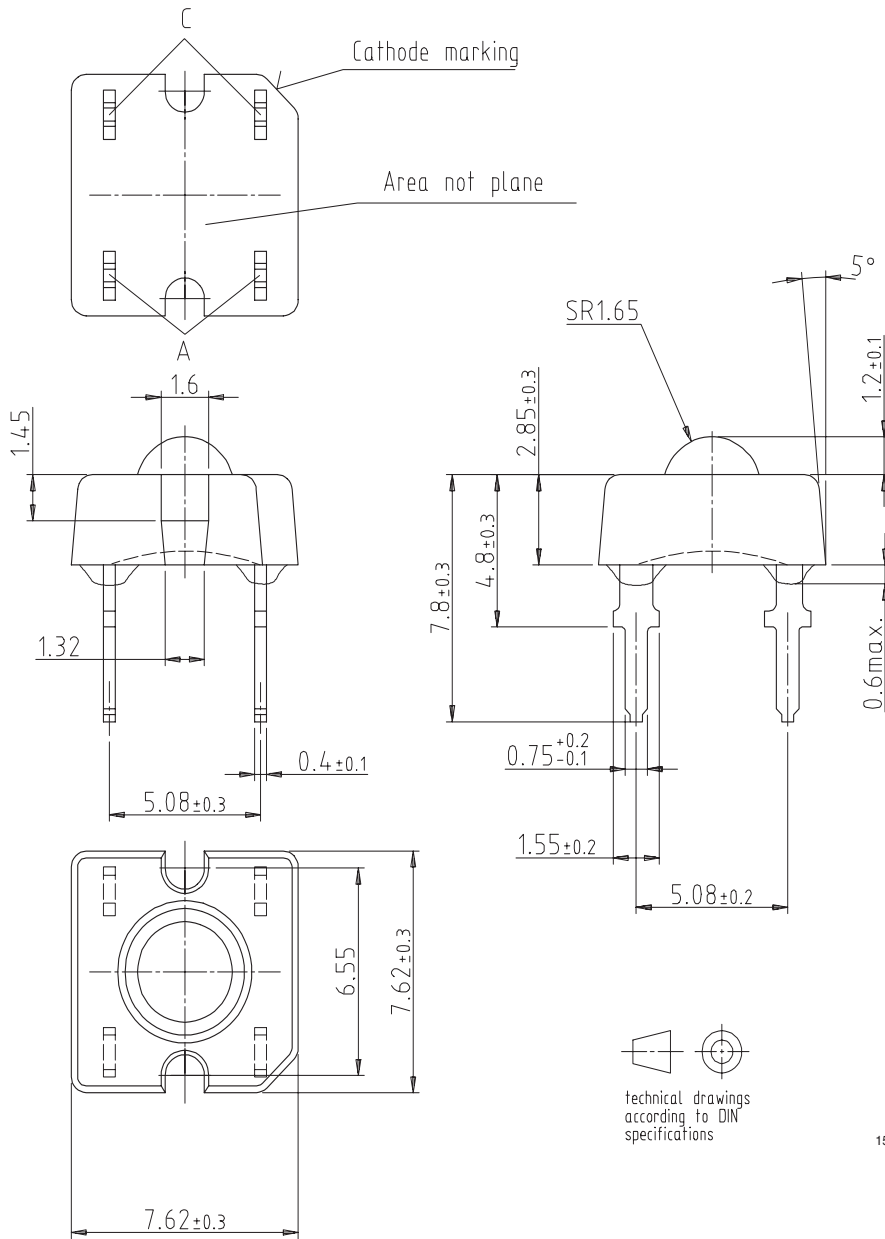

Figure 6. Thermal Resistance Junction Ambient vs. Cathode Padsizes



Package Dimensions in mm



15984

Ozone Depleting Substances Policy Statement

It is the policy of Vishay Semiconductor GmbH to

1. Meet all present and future national and international statutory requirements.
2. Regularly and continuously improve the performance of our products, processes, distribution and operating systems with respect to their impact on the health and safety of our employees and the public, as well as their impact on the environment.

It is particular concern to control or eliminate releases of those substances into the atmosphere which are known as ozone depleting substances (ODSs).

The Montreal Protocol (1987) and its London Amendments (1990) intend to severely restrict the use of ODSs and forbid their use within the next ten years. Various national and international initiatives are pressing for an earlier ban on these substances.

Vishay Semiconductor GmbH has been able to use its policy of continuous improvements to eliminate the use of ODSs listed in the following documents.

1. Annex A, B and list of transitional substances of the Montreal Protocol and the London Amendments respectively
2. Class I and II ozone depleting substances in the Clean Air Act Amendments of 1990 by the Environmental Protection Agency (EPA) in the USA
3. Council Decision 88/540/EEC and 91/690/EEC Annex A, B and C (transitional substances) respectively.

Vishay Semiconductor GmbH can certify that our semiconductors are not manufactured with ozone depleting substances and do not contain such substances.

We reserve the right to make changes to improve technical design
and may do so without further notice.

Parameters can vary in different applications. All operating parameters must be validated for each customer application by the customer. Should the buyer use Vishay Semiconductors products for any unintended or unauthorized application, the buyer shall indemnify Vishay Semiconductors against all claims, costs, damages, and expenses, arising out of, directly or indirectly, any claim of personal damage, injury or death associated with such unintended or unauthorized use.

Vishay Semiconductor GmbH, P.O.B. 3535, D-74025 Heilbronn, Germany
Telephone: 49 (0)7131 67 2831, Fax number: 49 (0)7131 67 2423