

LED Surface Mount Device

Unit in mm

Features

- 2.0(L) x 1.25(W) x 1.1(H) mm Size
 - Small Package - High Density Mounting is Available
- Available for Automounting Machine Use
- Reflow Soldering is Applicable
- Low Drive Current, High Intensity Light Emission
 - Recommended Forward Current: $I_F = 10 \text{ mA (DC)}$
- Fast Response Time
 - Capable of Pulse Operation
- High Power Luminous Intensity
- Applications:
 - Telephone Cordless/Cellular
 - Portable Instrument
 - Backlight, etc.

Line-Up

Product Name	Color	Material
TLPG1002	Pure Green	GaP
TLG1002	Green	GaP
TLGD1002	Green	GaP
TLYE1002	Yellow	InGaAlP
TLOE1002	Orange	InGaAlP
TLS1002	Red	GaAsP
TLRA1002	Red	GaAlAs

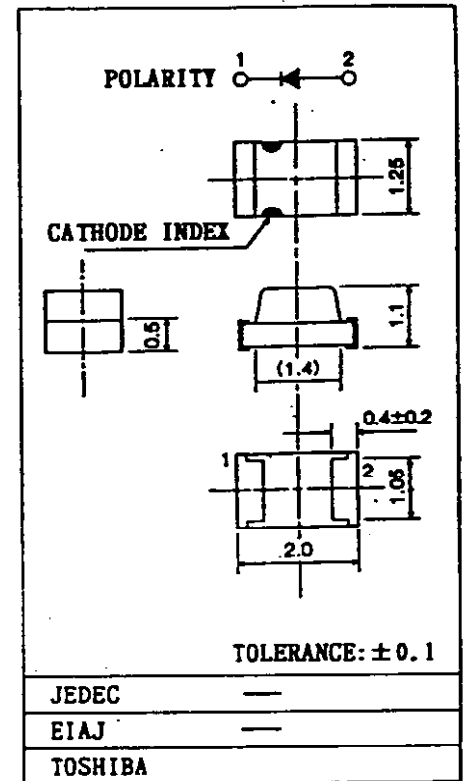

Weight : 2mg

The information contained here is subject to change without notice.

The information contained herein is presented only as guide for the applications of our products. No responsibility is assumed by TOSHIBA for any infringements of patents or other rights of the third parties which may result from its use. No license is granted by implication or otherwise under any patent or patent rights of TOSHIBA or others. These TOSHIBA products are intended for usage in general electronic equipments (office equipment, communication equipment, measuring equipment, domestic electrification, etc.) Please make sure that you consult with us before you use these TOSHIBA products in equipments which require high quality and/or reliability, and in equipments which could have major impact to the welfare of human life (atomic energy control, spaceship, traffic signal, combustion control, all types of safety devices, etc.). TOSHIBA cannot accept liability to any damage which may occur in case these TOSHIBA products were used in the mentioned equipments without prior consultation with TOSHIBA.

**TLG1002, TLGD1002, TLPG1002,
TLOE1002, TLYE1002, TLS1002, TLRA1002**

Maximum Ratings (T_a = 25°C)

Product Name	Forward Current (DC) I _F (mA)	Reverse Voltage V _R (V)	Power Dissipation P _D (mW)	Operating Temperature T _{opr} (°C)	Storage Temperature T _{stg} (°C)
TLPG1002	25	4	65.0	-25 ~ 80	-30 ~ 85
TLG1002	25	4	62.5		
TLGD1002	25	4	62.5		
TLYE1002	25	4	62.5		
TLOE1002	25	4	60.0		
TLS1002	25	4	65.0		
TLRA1002	25	4	60.0		

Electro-Optical Characteristics (T_a = 25°C)

Product Name	Emission Spectrum			Luminous Intensity			Forward Voltage			Reverse Current	
	λ _p	Δλ		I _v			V _F			I _R	
	Typ.	Typ.	I _F	Min.	Typ.	I _F	Typ.	Max.	I _F	Max.	V _R
TLPG1002	555	20	20	0.85	2.0	20	2.15	2.6	20	5	4
TLG1002	567	25	20	2.72	9.0	20	2.15	2.5	20	5	4
TLGD1002	570	25	20	4.76	15.0	20	2.1	2.5	20	5	4
TLYE1002	590	13	20	27.2	60.0	20	2.1	2.5	20	50	4
TLOE1002	612	15	20	27.2	60.0	20	2.0	2.4	20	50	4
TLS1002	635	40	20	1.53	5.0	20	2.05	2.6	20	50	4
TLRA1002	660	25	20	15.3	40.0	20	1.85	2.4	20	50	4
UNIT	nm		mA	mcd		mA	V		mA	μA	V

TLRA1002

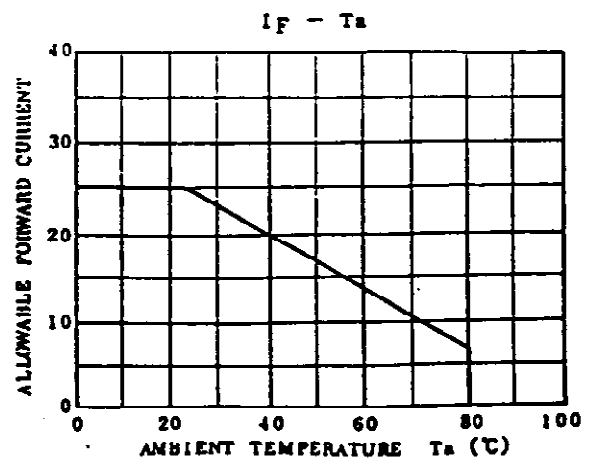
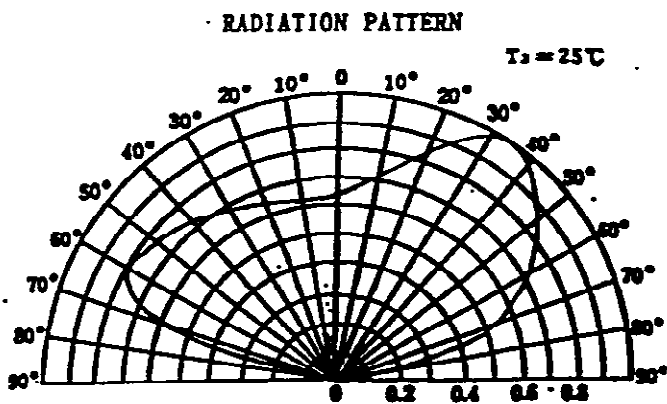
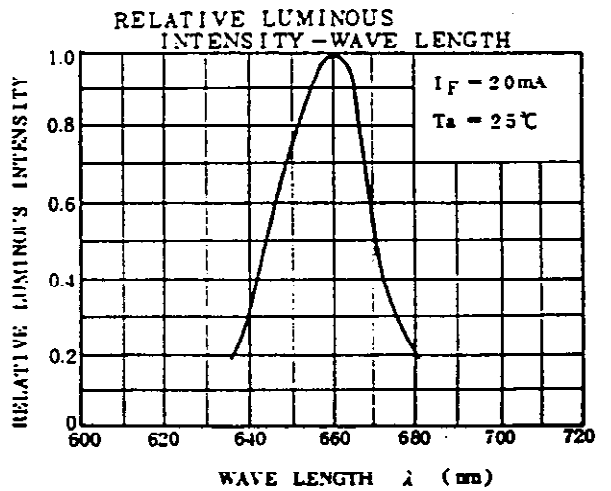
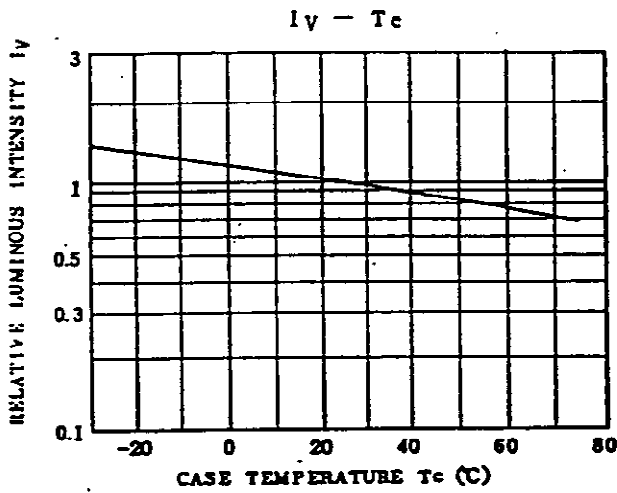
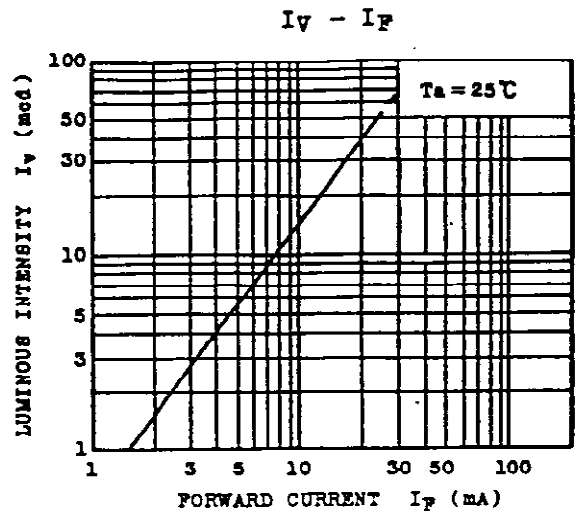
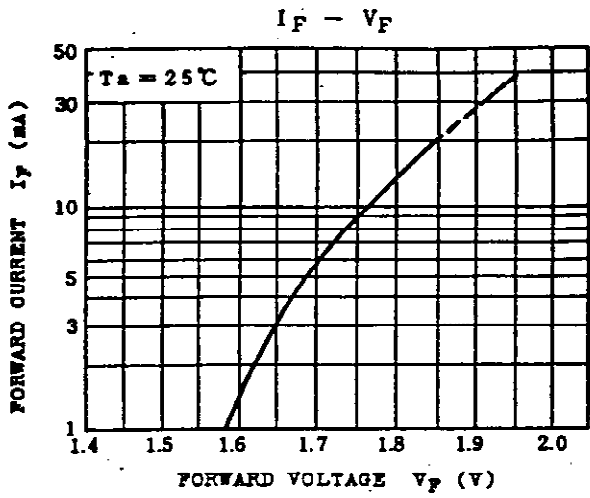

TLGD1002

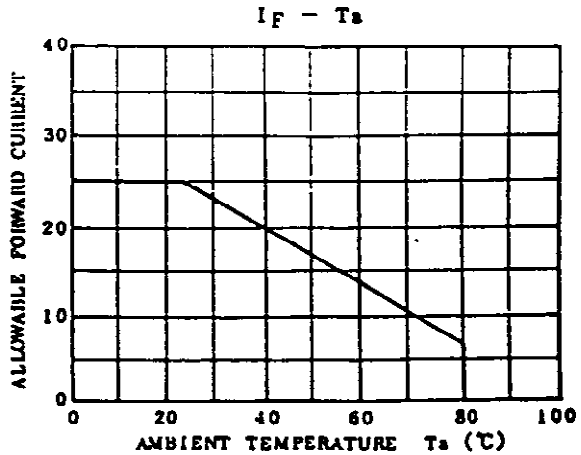
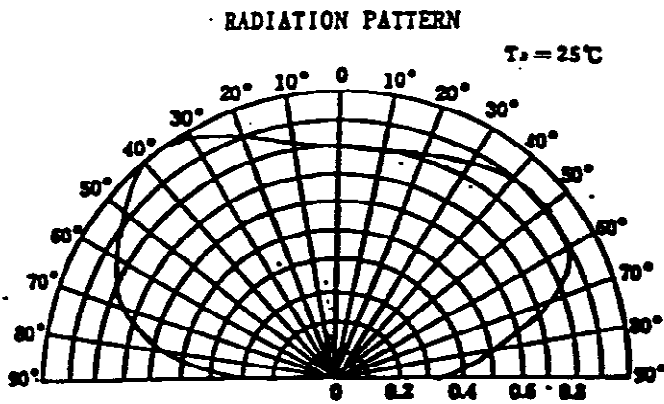
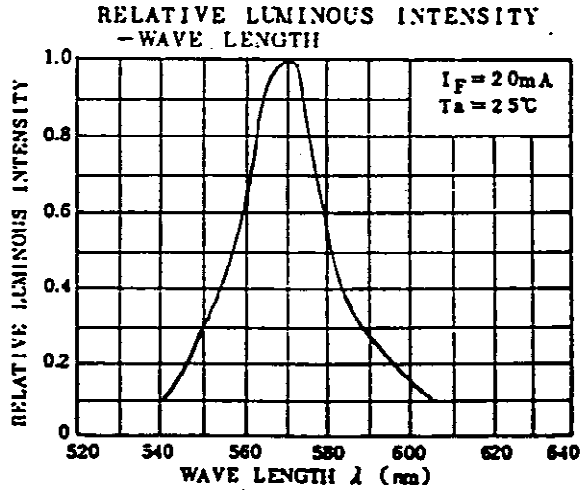
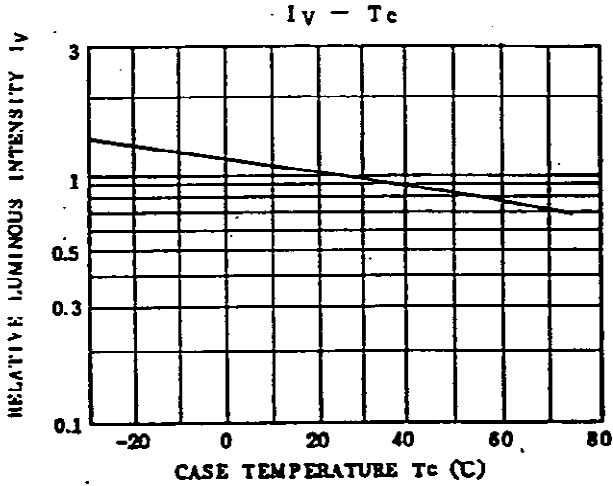
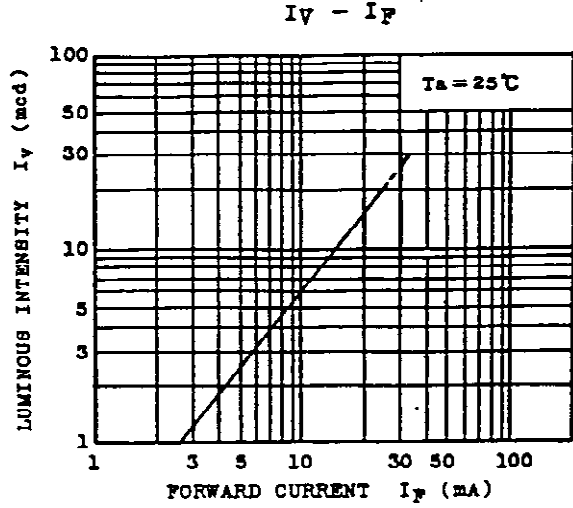
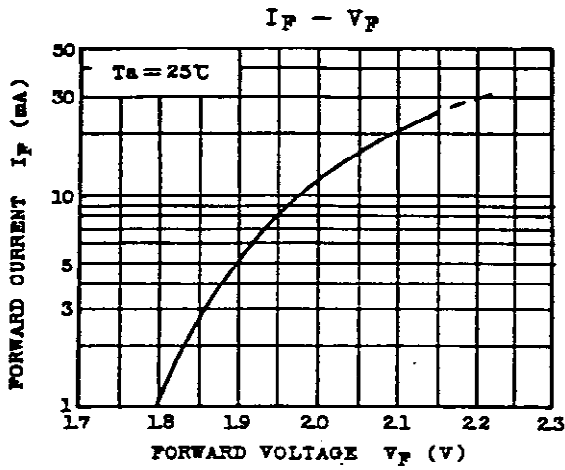

TLS1002

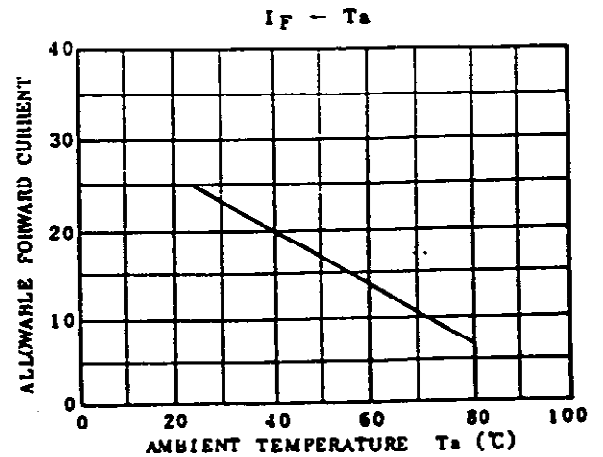
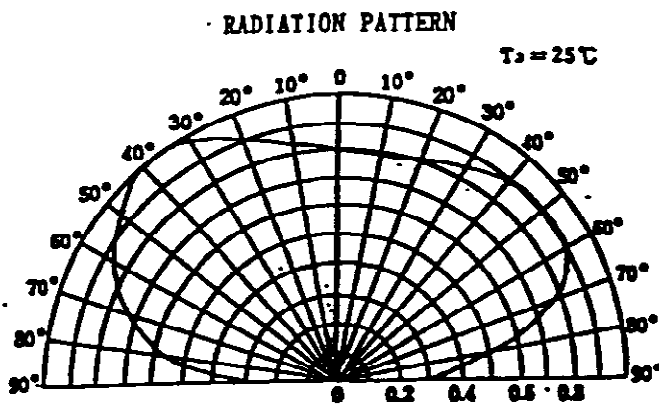
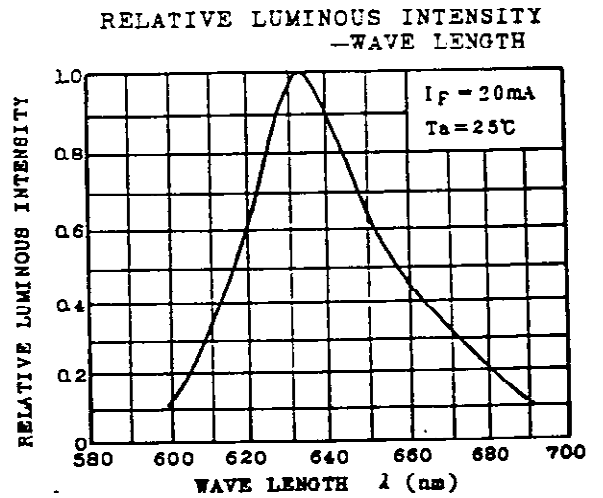
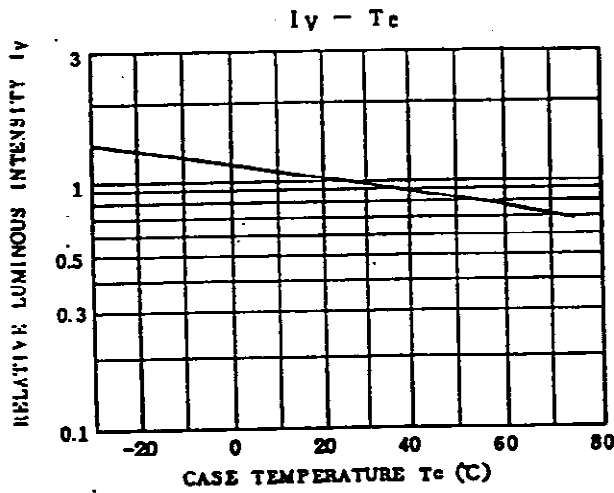
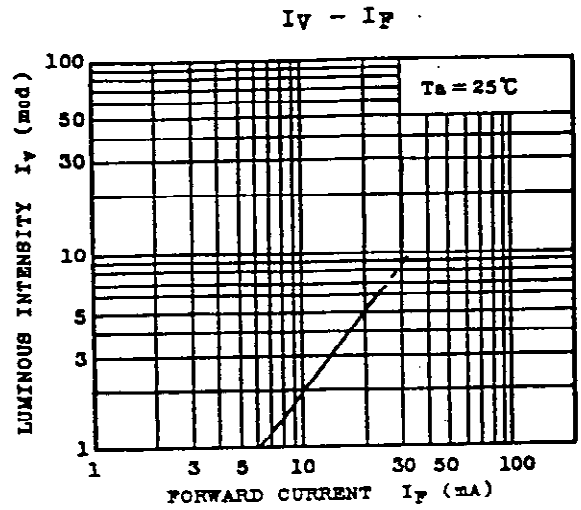
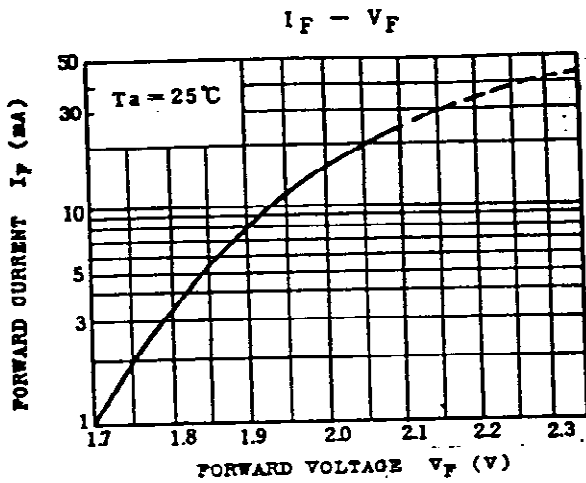

TLPG1002

$I_F - V_F$

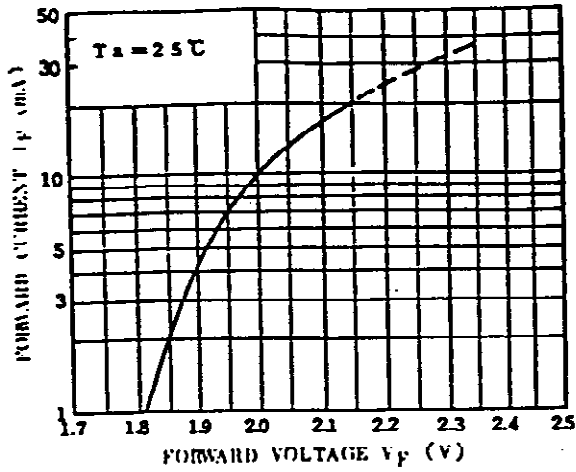

$I_V - I_F$

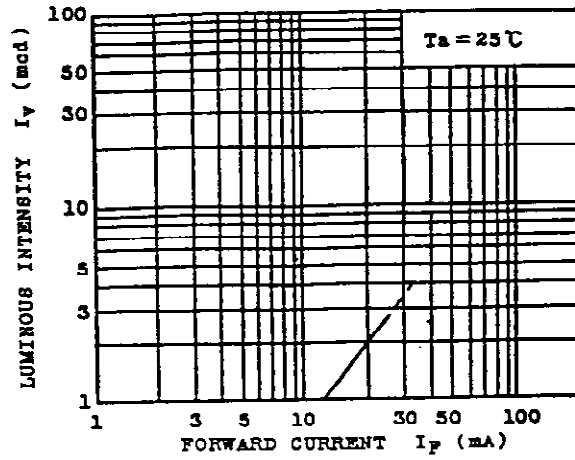

$I_V - T_c$

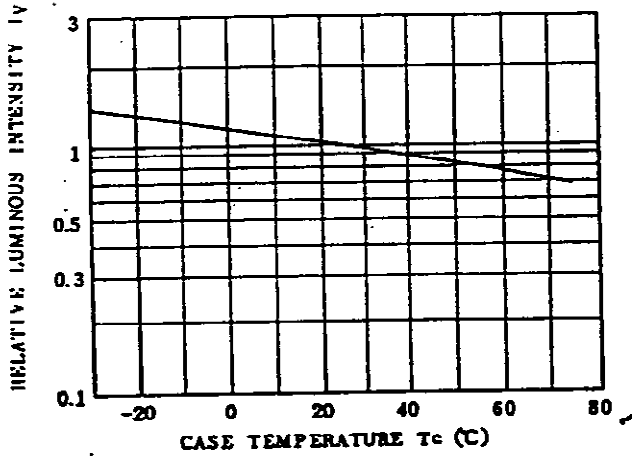

RELATIVE LUMINOUS INTENSITY
- WAVE LENGTH

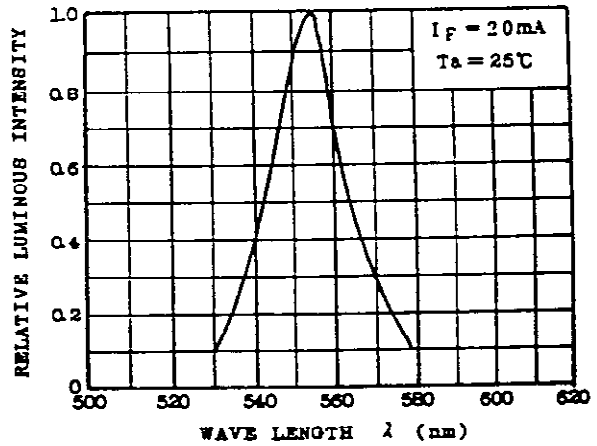

RADIATION PATTERN

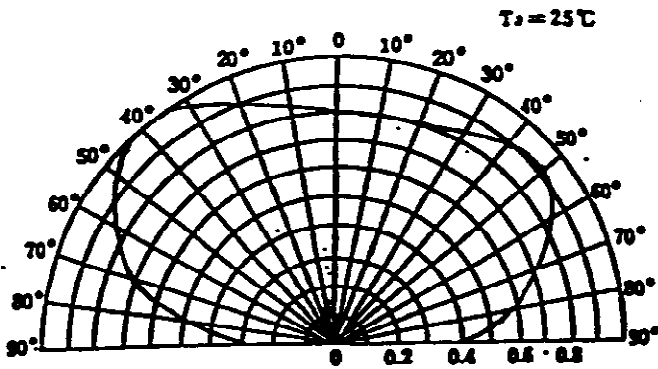

$I_F - T_a$

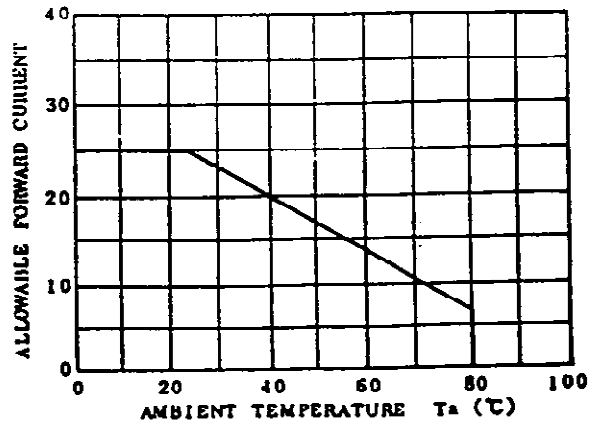

TLG1002

$I_F - V_F$

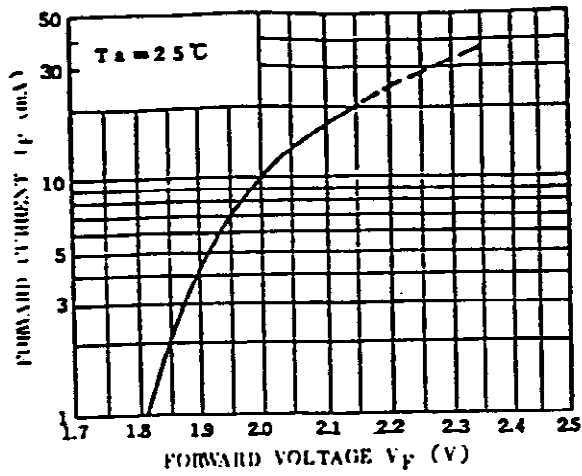

$I_V - I_F$

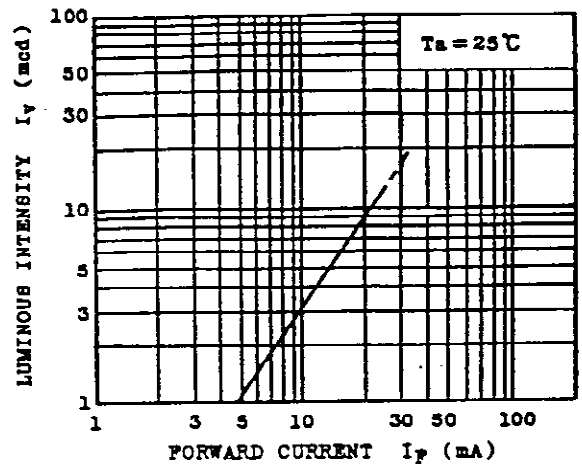

$I_V - T_c$

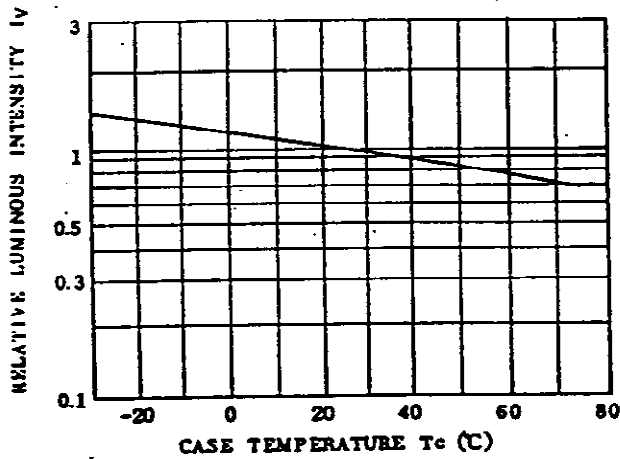

RELATIVE LUMINOUS INTENSITY
- WAVE LENGTH

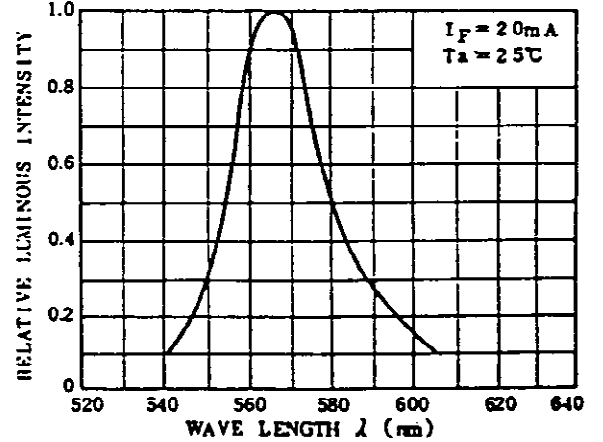

RADIATION PATTERN

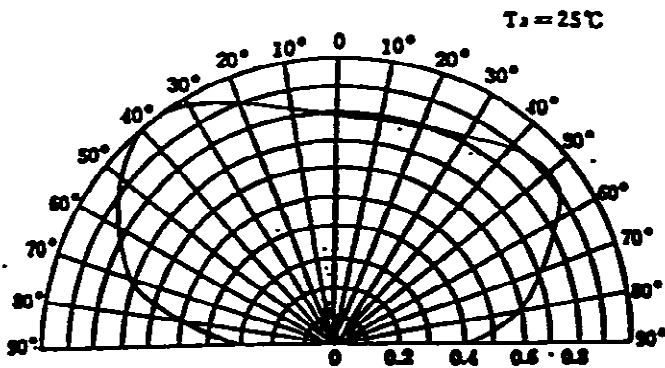

$I_F - T_a$

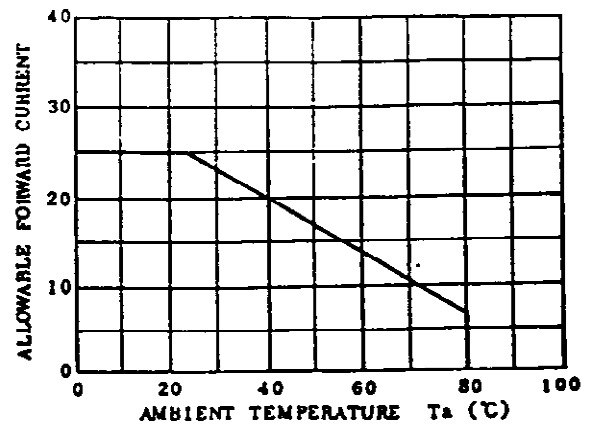

TLOE1002

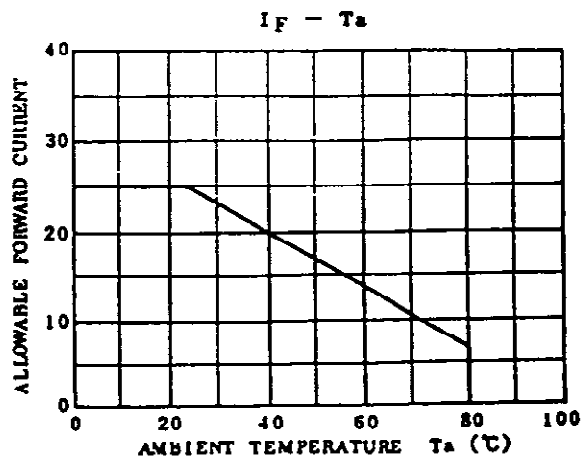
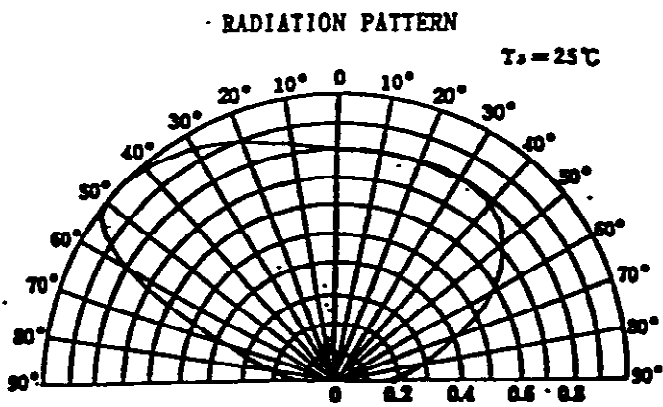
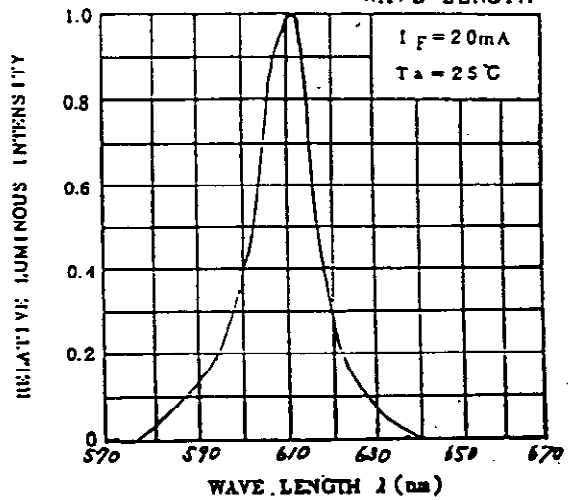
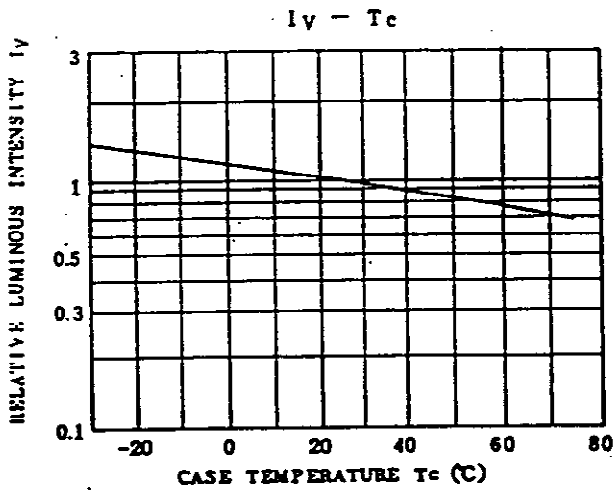
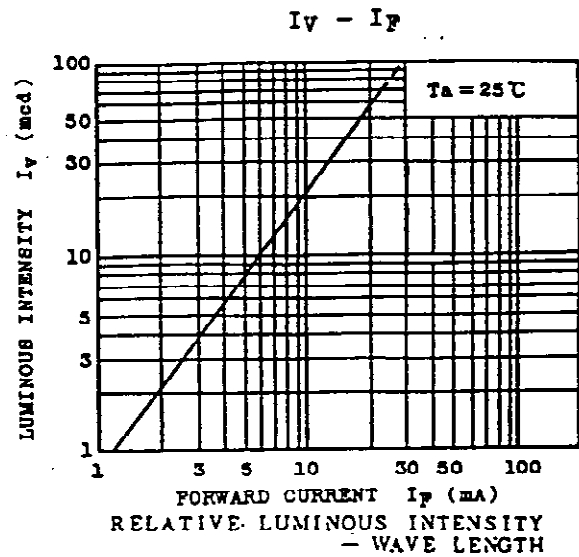
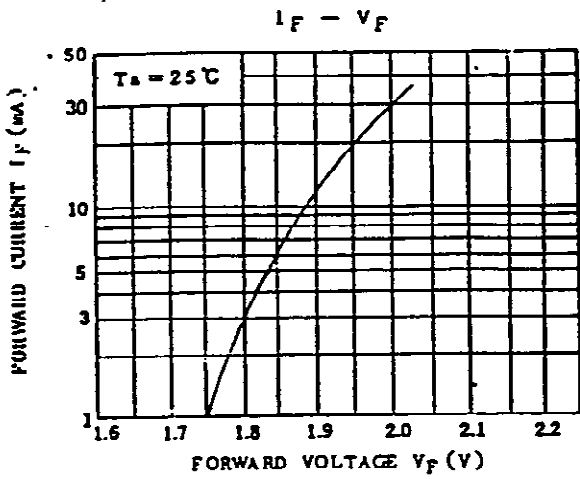

TLYE1002

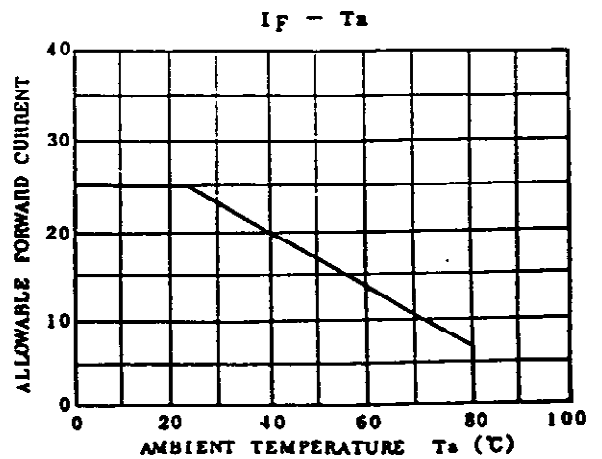
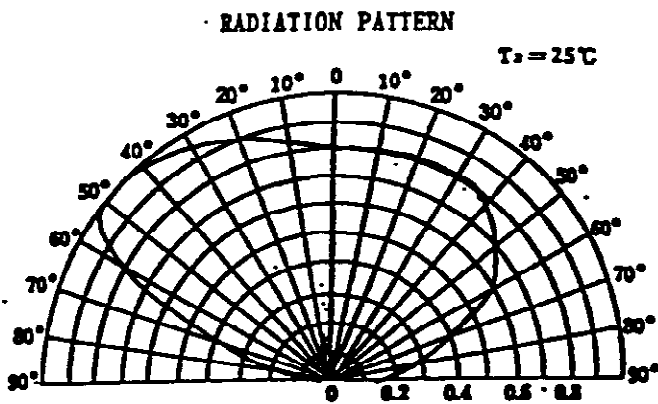
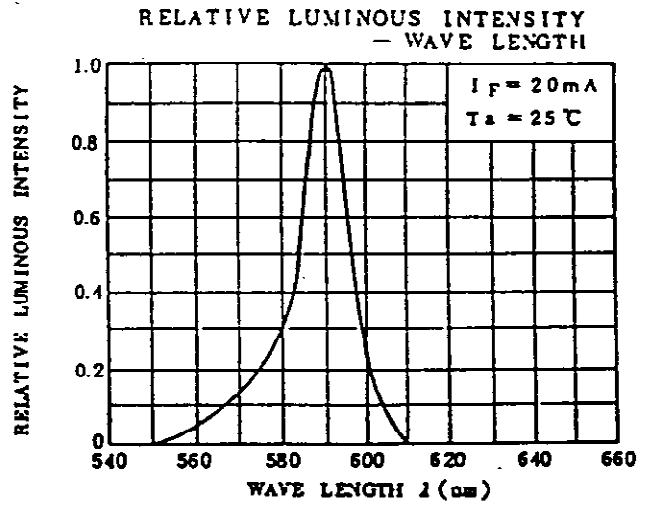
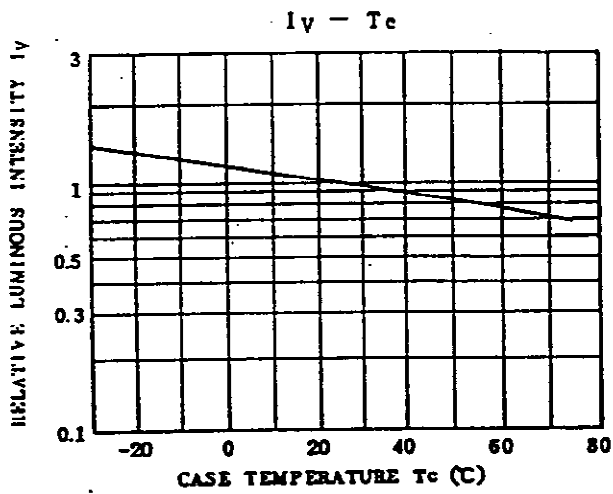
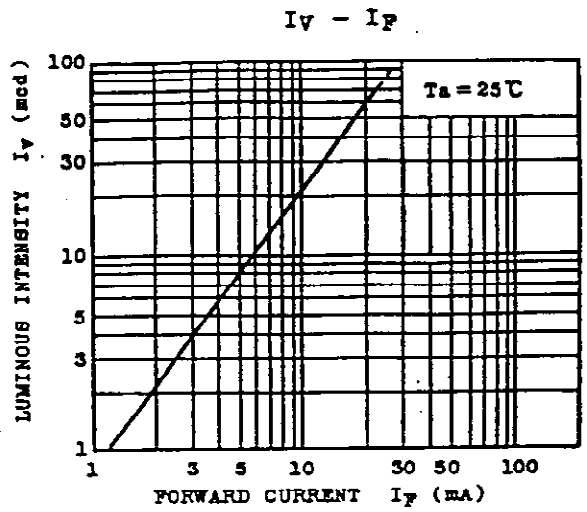
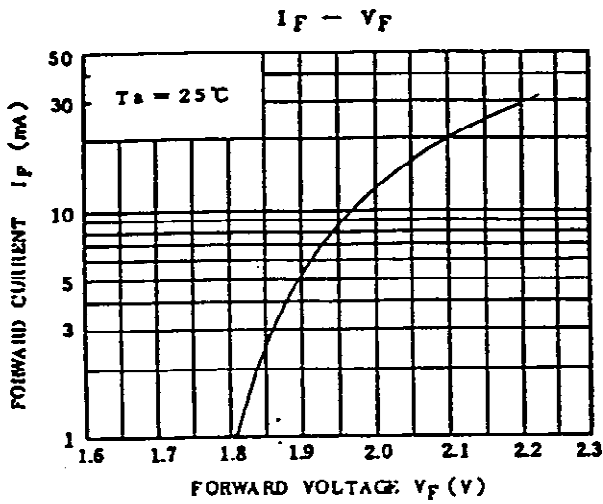

Taping Specifications:

Unit:mm

Dimensions of reel

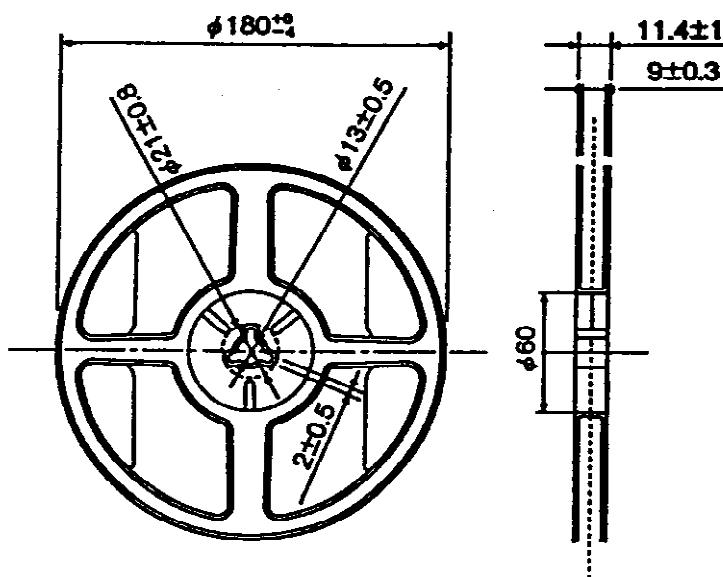

Dimensions of tape

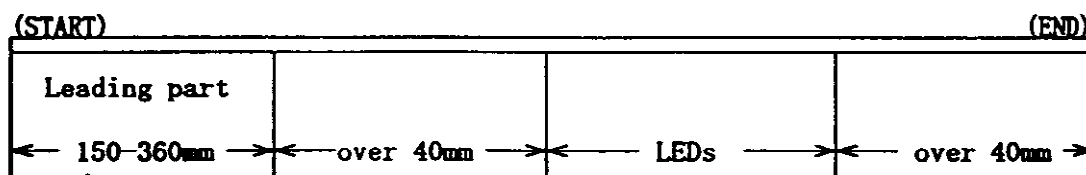
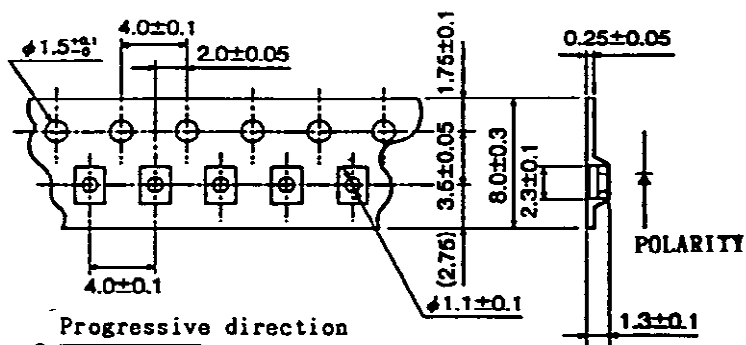

Loaded quantity per reel : 3,000 PCS

Packaging

LEDs are packed in an aluminum envelope with silica gel to avoid moisture absorption. After opening the package, storage at the following conditions is recommended since air exposure at soldering according to the moisture absorption influences optical characteristics.

- Temperature 5 ~ 30°C
- Humidity 60% RH (MAX.)

Please execute baking if it has been 6 months under packed or 1 week under opened. Recommended baking condition: 60°C, over 12 hours.

Soldering

1. Reflow soldering:

* It is recommended to use a reflow furnace of the upper and lower heater type.* The temperature profile as shown in Fig. 1 is recommended for soldering LEDs by the reflow furnace.

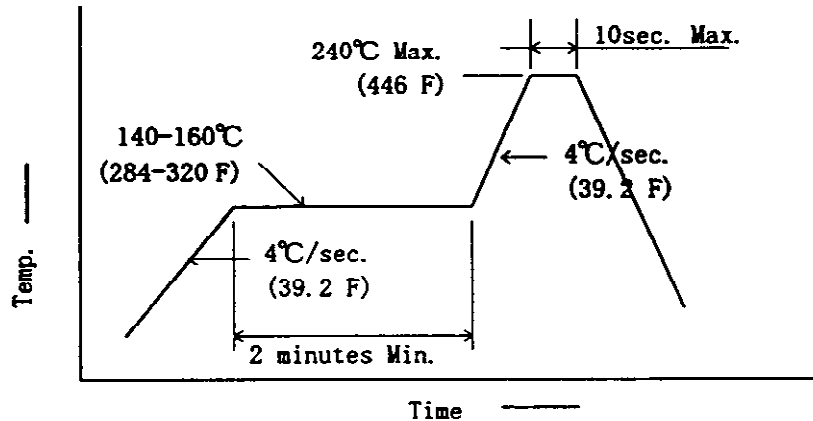

<Fig. 1>

<Recommend soldering pattern>

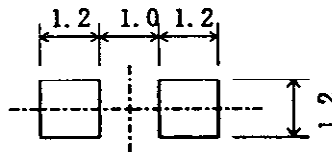

Revision by manual soldering	: Soldering iron	Less than 25W
	Temperature	Lower than 300°C
	Time	Within 3 seconds

2. Post-solder cleaning:

When cleaning after soldering is needed, the following conditions must be adhered to.

- Cleaning solvents: AK225 or Alcohol
- Temperature: 50°C (122°F) MAX. for 30 seconds, or
30°C (86°F) MAX. for 3 minutes MAX.
- Ultrasonic: 300W MAX.

Precaution for Mounting

1. No force to plastic part of LED when LED is under high temperature.
2. No friction using a hard thing to avoid injuring plastic part of LED.
3. No contact between LED and the other parts, when installing an assembled board into the set.