

MODEL NO. : TM035KDH08ISSUED DATE: 2009-05-05VERSION : Ver 1.3

- Preliminary Specification  
 Final Product Specification

Customer : \_\_\_\_\_

Approved by	Notes

SHANGHAI TIANMA Confirmed :

Prepared by	Checked by	Approved by

This technical specification is subjected to change without notice

The information contained herein is the exclusive property of SHANGHAI TIANMA MICRO-ELECTRONICS Corporation, and shall not be distributed, reproduced, or disclosed in whole or in part without prior written permission of SHANGHAI TIANMA MICRO-ELECTRONICS Corporation. 889 Huiqing Rd., Pudong New district, Shanghai, China, 201201



## Table of Contents

Coversheet .....	1
Record of Revision .....	3
1 General Specifications.....	4
2 Input/Output Terminals .....	5
3 Absolute Maximum Ratings.....	7
4 Electrical Characteristics .....	8
5 Timing Chart.....	10
6 Optical Characteristics .....	17
7 Environmental / Reliability Tests.....	21
8 Mechanical Drawing .....	23
9 Packing Drawing .....	24
10 Precautions For Use of LCD Modules .....	25

The information contained herein is the exclusive property of SHANGHAI TIANMA MICRO-ELECTRONICS Corporation, and shall not be distributed, reproduced, or disclosed in whole or in part without prior written permission of SHANGHAI TIANMA MICRO-ELECTRONICS Corporation. 889 Huiqing Rd., Pudong New district, Shanghai, China, 201201





## 1 General Specifications

Feature		Spec
<b>Display Spec</b>	Size	3.5 inch
	Resolution	320(RGB) x 240
	Interface	RGB/CCIR656/601
	Color Depth	16.7M
	Technology Type	a-Si
	Pixel Pitch (mm)	0.219x0.219
	Pixel Configuration	R.G.B. Vertical Stripe
	Display Mode	TM with Normally White
	Surface Treatment(Up Polarizer)	Clear type (3H)
	Viewing Direction	12 o'clock
	Gray Scale Inversion Direction	6 o'clock
<b>Mechanical Characteristics</b>	LCM (W x H x D) (mm)	76.90 x 63.90 x 3.15
	Active Area(mm)	70.08 x 52.56
	With /Without TSP	Without TSP
	Weight (g)	TBD
	LED Numbers	6LEDs

Note 1: Viewing direction for best image quality is different from TFT definition, there is a 180 degree shift.

Note 2: Requirements on Environmental Protection: RoHS.

Note 3: LCM weight tolerance: +/- 5%.

The information contained herein is the exclusive property of SHANGHAI TIANMA MICRO-ELECTRONICS Corporation, and shall not be distributed, reproduced, or disclosed in whole or in part without prior written permission of SHANGHAI TIANMA MICRO-ELECTRONICS Corporation. 889 Huiqing Rd., Pudong New district, Shanghai, China, 201201



## 2 Input/Output Terminals

Matching connector: Elco: 6240 serials

No	Symbol	I/O	Description	Remarks
1	LED_Cathode	P	LED_Cathode	
2	LED_Cathode	P	LED_Cathode	
3	LED_Anode	P	LED_Anode	
4	LED_Anode	P	LED_Anode	
5	NC	--	No Connection	
6	NC	--	No Connection	
7	NC	--	No Connection	
8	RESET	I	Reset	
9	SPENA	I	Serial Port Data Enable Signal	
10	SPCK	I	SPI Serial Clock	
11	SPDA	I	SPI Serial Data Input	
12	DATA0	I	Data Bus	
13	DATA1	I	Data Bus	
14	DATA2	I	Data Bus	
15	DATA3	I	Data Bus	
16	DATA4	I	Data Bus	
17	DATA5	I	Data Bus	
18	DATA6	I	Data Bus	
19	DATA7	I	Data Bus	
20	DATA8	I	Data Bus	
21	DATA9	I	Data Bus	
22	DATA10	I	Data Bus	
23	DATA11	I	Data Bus	
24	DATA12	I	Data Bus	
25	DATA13	I	Data Bus	
26	DATA14	I	Data Bus	
27	DATA15	I	Data Bus	
28	DATA16	I	Data Bus	
29	DATA17	I	Data Bus	
30	DATA18	I	Data Bus	
31	DATA19	I	Data Bus	
32	DATA20	I	Data Bus	

The information contained herein is the exclusive property of SHANGHAI TIANMA MICRO-ELECTRONICS Corporation, and shall not be distributed, reproduced, or disclosed in whole or in part without prior written permission of SHANGHAI TIANMA MICRO-ELECTRONICS Corporation. 889 Huiqing Rd., Pudong New district, Shanghai, China, 201201



33	DATA21	I	Data Bus	
34	DATA22	I	Data Bus	
35	DATA23	I	Data Bus	
36	HSYNC	I	Horizontal Synchronous Signal	
37	VSYNC	I	Vertical Synchronous Signal	
38	DOTCLK	I	Data Clock	
39	NC	--	No Connection	
40	NC	--	No Connection	
41	VDD	P	Digital Power Supply	
42	VDD	P	Digital Power Supply	
43	NC	--	No Connection	
44	NC	--	No Connection	
45	NC	--	No Connection	
46	NC	--	No Connection	
47	NC	--	No Connection	
48	NC	--	No Connection	
49	NC	--	No Connection	
50	NC	--	No Connection	
51	NC	--	No Connection	
52	DEN	I	Data Enabling Signal	
53	GND	P	Ground	
54	GND	P	Ground	

Note2-1: I/O definition:

I----Input O----Output P----Power/Ground

Note2-2: Interface controlled by SPI, please refer to the SPI command list.

Mode	D(23:16)	D(15:8)	D(7 : 0)	HSYNC	VSYNC	DEN
CCIR 656	DATA(23:16)	GND	GND	NC	NC	NC
CCIR 601	DATA(23:16)	GND	GND	HSYNC	VSYNC	NC
8 Bit RGB	DATA(23:16)	GND	GND	HSYNC	VSYNC	NC for HV Mode
						DEN for DEN Mode
24 Bit RGB	DATA(23:16)	DATA(15:8)	DATA(7:0)	HSYNC	VSYNC	NC for HV Mode
						DEN for DEN Mode

The information contained herein is the exclusive property of SHANGHAI TIANMA MICRO-ELECTRONICS Corporation, and shall not be distributed, reproduced, or disclosed in whole or in part without prior written permission of SHANGHAI TIANMA MICRO-ELECTRONICS Corporation. 889 Huiqing Rd., Pudong New district, Shanghai, China, 201201



### 3 Absolute Maximum Ratings

#### 3.1 Driving TFT LCD Panel

GND=0V, Ta = 25°C

Item	Symbol	Min	Max	Unit	Remark
Power Supply Voltage	VDD	-0.3	5.0	V	
Logic Input Signal Voltage	DATA0~DATA17,RESB SPENA,SPCK, SPDA,HSYNC VSYNC,DOTCLK,DEN	-0.3	VDD+0.3	V	
Back Light Forward Current	I <sub>LED</sub>	--	25	mA	For each LED
Operating Temperature	T <sub>OPR</sub>	-20	60	°C	
Storage Temperature	T <sub>STG</sub>	-30	70	°C	

The information contained herein is the exclusive property of SHANGHAI TIANMA MICRO-ELECTRONICS Corporation, and shall not be distributed, reproduced, or disclosed in whole or in part without prior written permission of SHANGHAI TIANMA MICRO-ELECTRONICS Corporation. 889 Huiqing Rd., Pudong New district, Shanghai, China, 201201



## 4 Electrical Characteristics

### 4.1 Driving TFT LCD Panel

GND=0V, Ta=25°C

Item	Symbol	Min	Typ	Max	Unit	Remark
Power Supply Voltage	VDD	3.0	3.3	3.6	V	
Input Signal Voltage	Low Level	V <sub>IL</sub>	0	--	0.2xVCC	DATA0~DATA23,RESET SPENA,SPCK SPDA,HSYNC VSYNC,DOTCLK,DEN
	High Level	V <sub>IH</sub>	0.8xVCC	--	VDD	
(Panel+ LSI) Power Consumption	Black Mode (60Hz)	--	46	50	mW	
	Standby Mode	--	0.2	--	mW	

### 4.2 Driving Backlight

Ta=25°C

Item	Symbol	Min	Typ	Max	Unit	Remark
Forward Current	I <sub>F</sub>	--	20	25	mA	For each LED
Forward Voltage	V <sub>F</sub>	--	19.2	21.6	V	
Power Consumption	W <sub>BL</sub>	--	384	540	mW	Note1,2,3

Note 1: The figure below shows the connection of backlight LED.

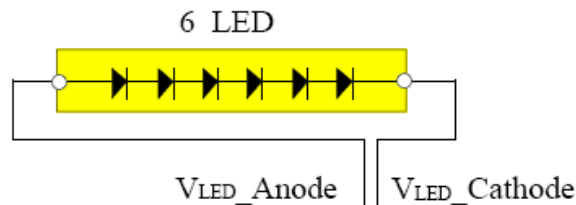

Note 2: One LED : I<sub>F</sub> =20 mA, V<sub>F</sub> =3.2V

Note 3: The minimal life of LED : 20,000 hours(I<sub>F</sub> =20 mA ,one LED).





4.3 Block Diagram

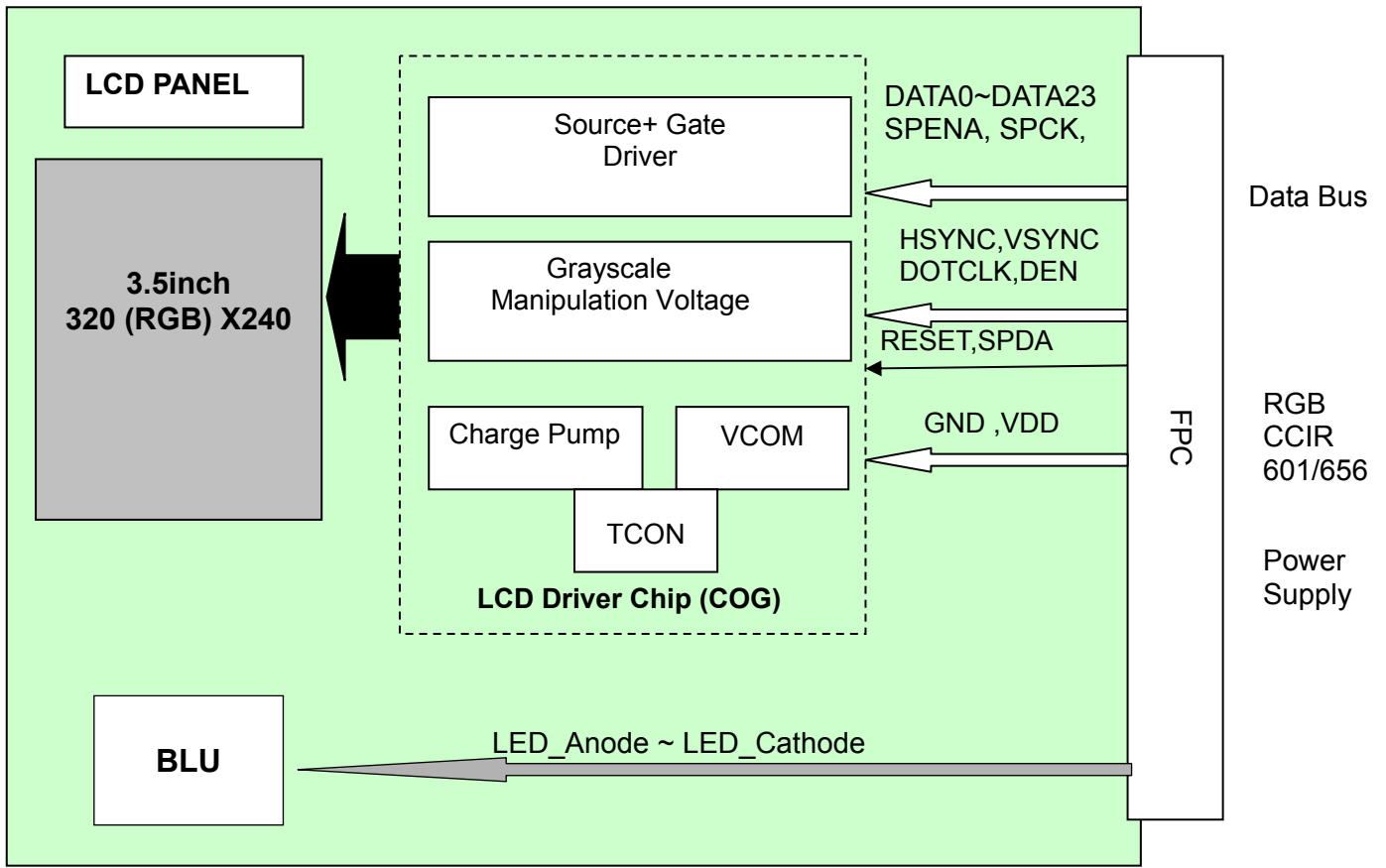



## 5 Timing Chart

### 5.1 Timing Parameter

(VDD=3.3V GND =0V,Ta=25°C)

Parameter	Symbol	Min	Typ	Max	Unit	Condition
DOTCLK Time	$T_{clk}$	$1/\text{Max}(F_{clk})$	--	$1/\text{Min}(F_{clk})$	ns	
DOTCLK Pulse Duty	$T_{chw}$	40	50	60	%	$T_{clk}$
HSYNC to DOTCLK	$T_{hc}$	--	--	1	DOTCLK	--
HSYNC Width	$T_{hwh}$	1	--	--	DOTCLK	--
VSYNC Width	$T_{vwh}$	1	--	--	ns	--
HSYNC Period Time	$T_h$	60	63.56	67	ns	--
VSYNC Set-up Time	$T_{vst}$	8	--	--	ns	--
VSYNC Hold Time	$T_{vhd}$	10	--	--	ns	--
HSYNC Setup Time	$T_{hst}$	8	--	--	ns	--
HSYNC Hold Time	$T_{hhd}$	10	--	--	ns	--
Data Set-up Time	$T_{dsu}$	8	--	--	ns	DATA0~DATA23to DOTCLK
Data Hold Time	$T_{dhd}$	10	--	--	ns	DATA0~DATA23 to DOTCLK
DEN Set up Time	$T_{esu}$	12	--	--	ns	DEN to DOTCLK

Note:

Each DOTCLK Frequency of 24 Bit RGB Mode,8 Bit RGB Mode,CCIR601and CCIR656 are different.

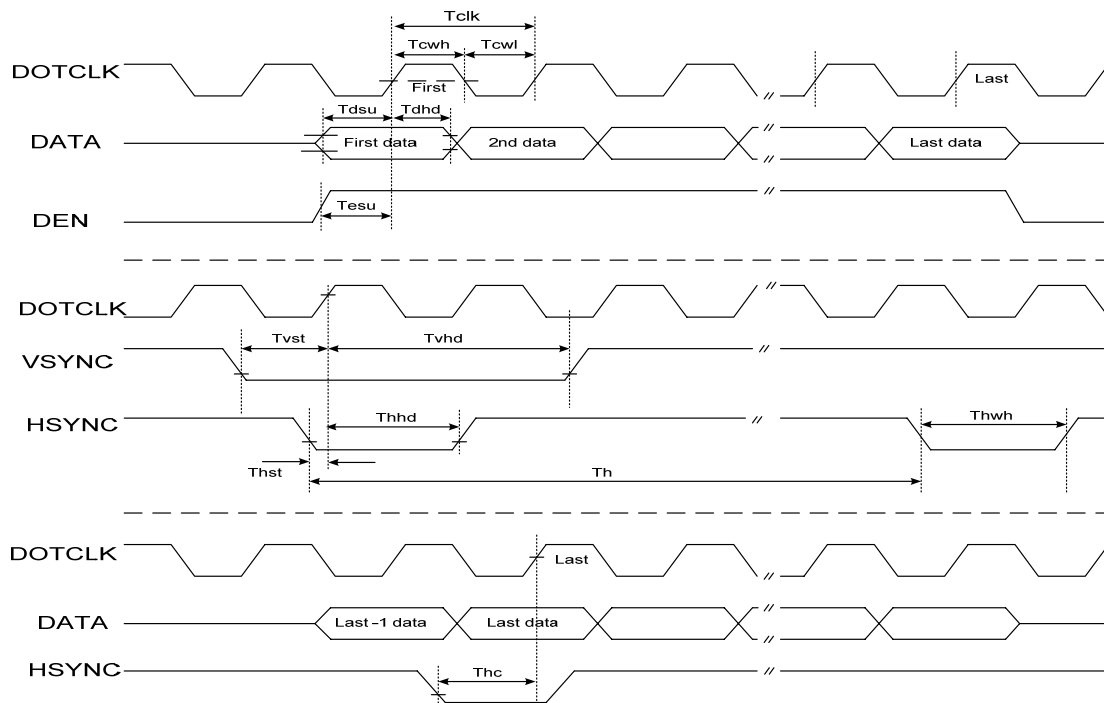

The information contained herein is the exclusive property of SHANGHAI TIANMA MICRO-ELECTRONICS Corporation, and shall not be distributed, reproduced, or disclosed in whole or in part without prior written permission of SHANGHAI TIANMA MICRO-ELECTRONICS Corporation. 889 Huiqing Rd., Pudong New district, Shanghai, China, 201201



5.2 24 Bit RGB Mode for 320RGB x 240

Parameter	Symbol	Min	Typ	Max	Unit	Condition
DOTCLK Frequency	$F_{clk}$	6.1	6.4	8.0	MHz	VDD=3.0V~3.6V
DOTCLK Cycle Time	$T_{clk}$	125	156	164	ns	
DOTCLK Pulse Duty	$T_{cwh}$	40	50	60	%	
Time that HSYNC to 1st data input(NTSC)	$T_{hs}$	40	70	255	DOTCLK	

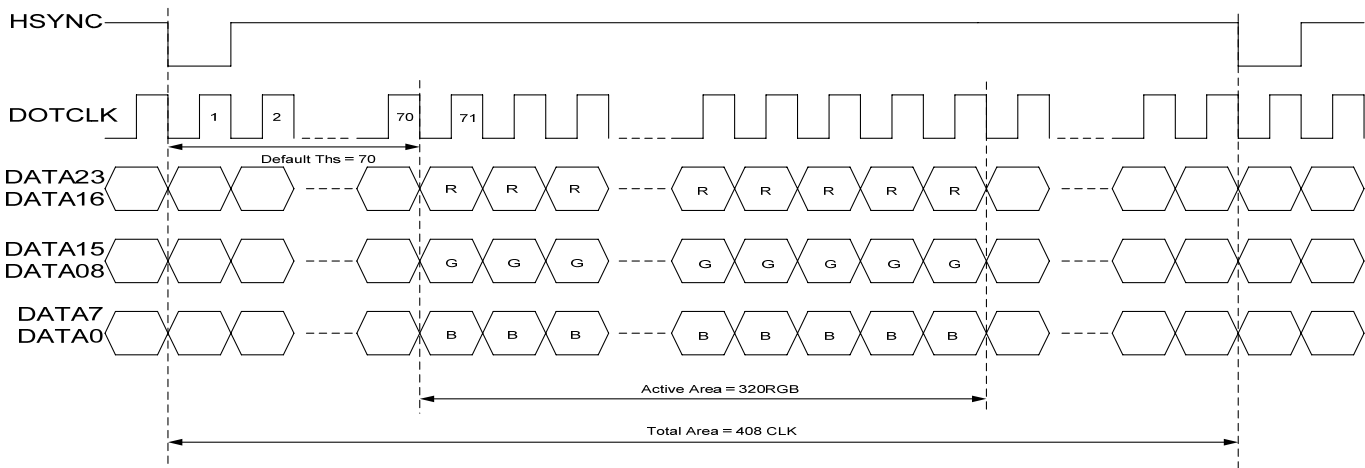
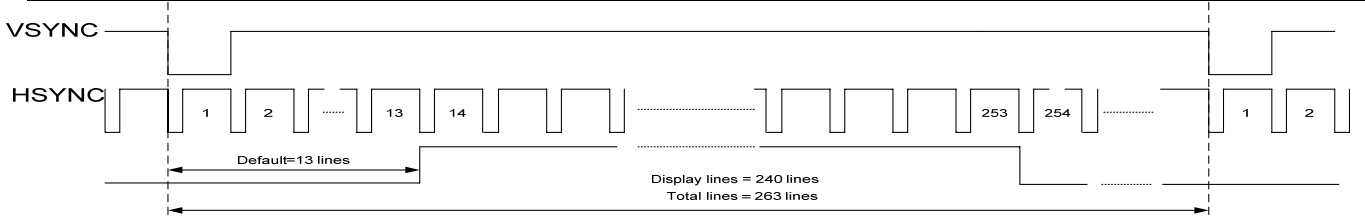

5.3 8 Bit RGB Mode for 320RGB x 240

Parameter	Symbol	Min	Typ	Max	Unit	Condition
DOTCLK Frequency	$F_{clk}$	--	27	30	MHz	VDD=3.0~3.6V
DOTCLK Cycle Time	$T_{clk}$	--	37	--	ns	
Time that HSYNC to 1'st data input(NTSC)	$T_{hs}$	35	70	255	DOTCLK	

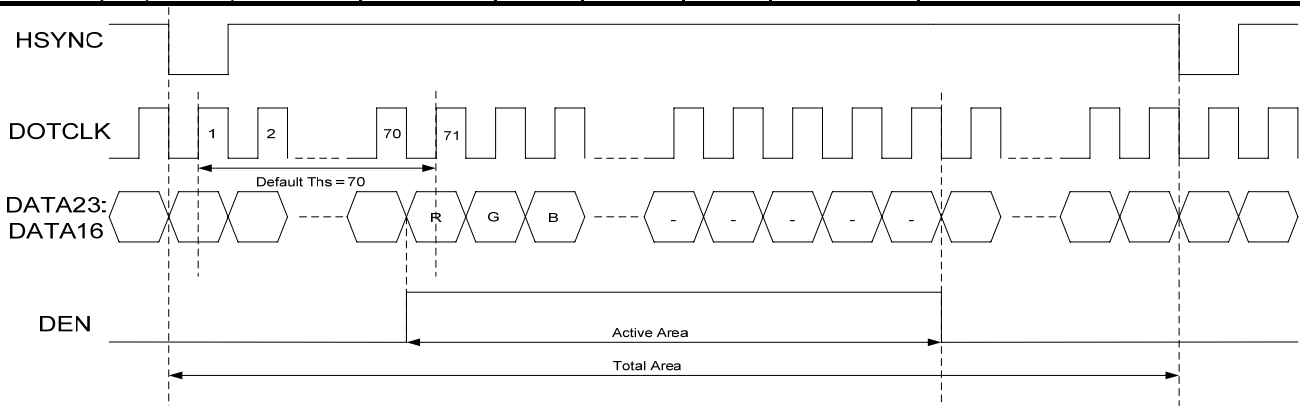

The information contained herein is the exclusive property of SHANGHAI TIANMA MICRO-ELECTRONICS Corporation, and shall not be distributed, reproduced, or disclosed in whole or in part without prior written permission of SHANGHAI TIANMA MICRO-ELECTRONICS Corporation. 889 Huiqing Rd., Pudong New district, Shanghai, China, 201201



5.4 CCIR601

Parameter	Symbol	Min	Typ	Max	Unit	Condition
DOTCLK Frequency	$F_{clk}$	--	24.54 27	30	MHz	VDD=3.0V~3.6V
DOTCLK Cycle Time	$T_{clk}$	--	40/37	--	ns	
Time From HSYNC to 1st data input(PAL)	$T_{hs}$	128	264	--	DOTCLK	
Time From HSYNC to 1st data input(NTSC)	$T_{hs}$	128	244	--	DOTCLK	

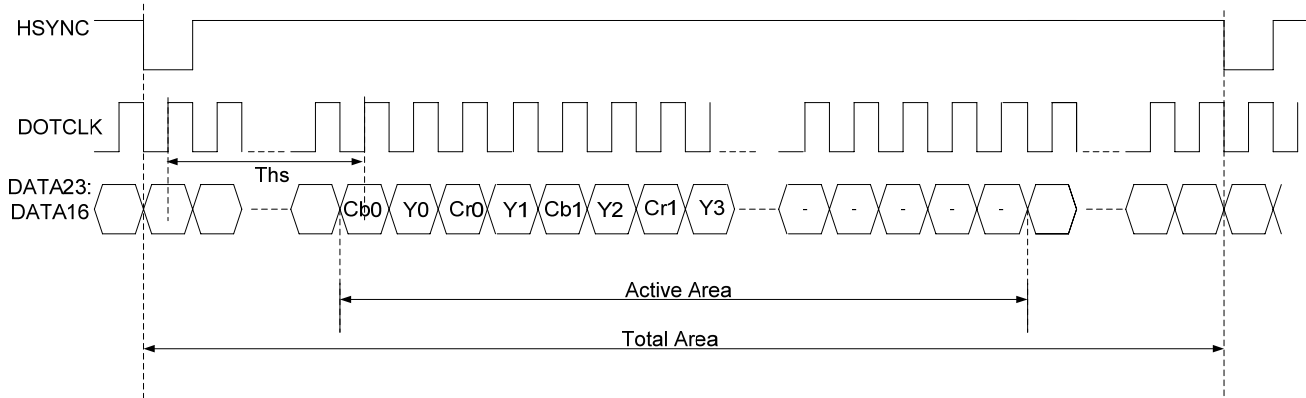

5.5 CCIR656

Parameter	Symbol	Min	Typ	Max	Unit	Condition
DOTCLK Frequency	$F_{clk}$	--	27	30	MHz	VDD=3.0V~3.6V
DOTCLK Cycle Time	$T_{clk}$	--	37	--	ns	
Time that EVA to 1'st data input(PAL)	$T_{hs}$	128	288	--	DOTCLK	
Time that EVA to 1'st data input(NTSC)	$T_{hs}$	128	276	--	DOTCLK	

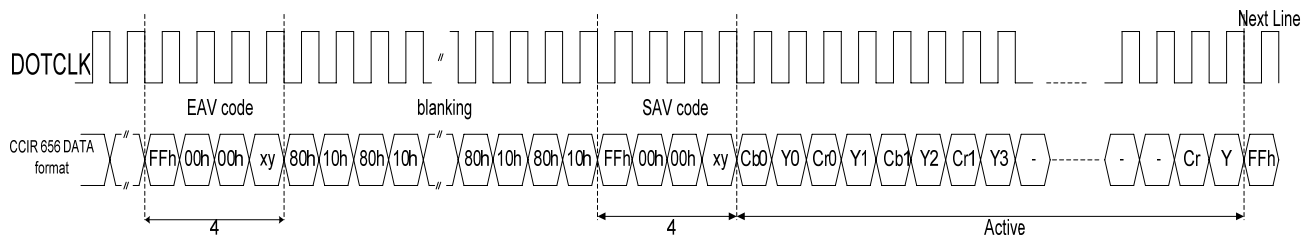

5.6 3-Wire Serial Communication AC Timing

Parameter	Symbol	Min	Typ	Max	Unit	Remark
Serial Clock	$T_{SPCK}$	320	--	--	ns	
SPCK Pulse Duty	$T_{scdut}$	40	50	60	%	
Serial Data Setup Time	$T_{isu}$	120	--	--	ns	
Serial Data Hold Time	$T_{ihd}$	120	--	--	ns	

The information contained herein is the exclusive property of SHANGHAI TIANMA MICRO-ELECTRONICS Corporation, and shall not be distributed, reproduced, or disclosed in whole or in part without prior written permission of SHANGHAI TIANMA MICRO-ELECTRONICS Corporation. 889 Huiqing Rd., Pudong New district, Shanghai, China, 201201





001010b	R0A	88h	R/W	Hue/Saturation control register
001011b	R0B	88h	R/W	R/B sub-contrast control register
001100b	R0C	20h	R/W	R sub-brightness control register
001101b	R0D	20h	R/W	B sub-brightness control register
001110b	R0E	10h	R/W	VCOMDC level control register
001111b	R0F	24h	R/W	VGL/VGH VOCMAC level control register
010000b	R10	04h	R/W	VGAM2 level control register
010001b	R11	24h	R/W	VGAM3/4 level control register
010010b	R12	24h	R/W	VGAM5/6 level control register
011110b	R1E	00h	R/W	VCOMDC Trim function control register
100000b	R20	00h	R/W	Wide and narrow display mode control register

Note :

R03: c4h:CCIR656 Mode

c2h:CCIR601 Mode

c8h:8 bit RGB Mode(HV Mode)

c9h:8 bit RGB Mode(DEN Mode)

cch(default):24 bit RGB Mode (HV mode)

cdh:24 bit RGB Mode (DEN mode)

R0E:

10h:if LCM is programed by OTP,please use this value.VCOM DC is decides by OTP's value.

6Bh: :if LCM isn't programed by OTP,please use this value. VCOM DC=1.56V.

R0F:

A4h(default):VGH=15V,VGL=-10V.

24h(recommend): VGH=15V,VGL=-7V.

The information contained herein is the exclusive property of SHANGHAI TIANMA MICRO-ELECTRONICS Corporation, and shall not be distributed, reproduced, or disclosed in whole or in part without prior written permission of SHANGHAI TIANMA MICRO-ELECTRONICS Corporation. 889 Huiqing Rd., Pudong New district, Shanghai, China, 201201



5.8 Reset Timing

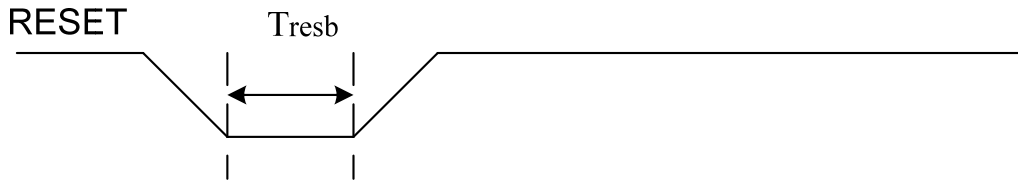

Parameter	Min	Typ	Max	Unit	Conditions
T <sub>resb</sub>	40	----	----	us	VDD = 3.3V

5.9 Power On Sequence

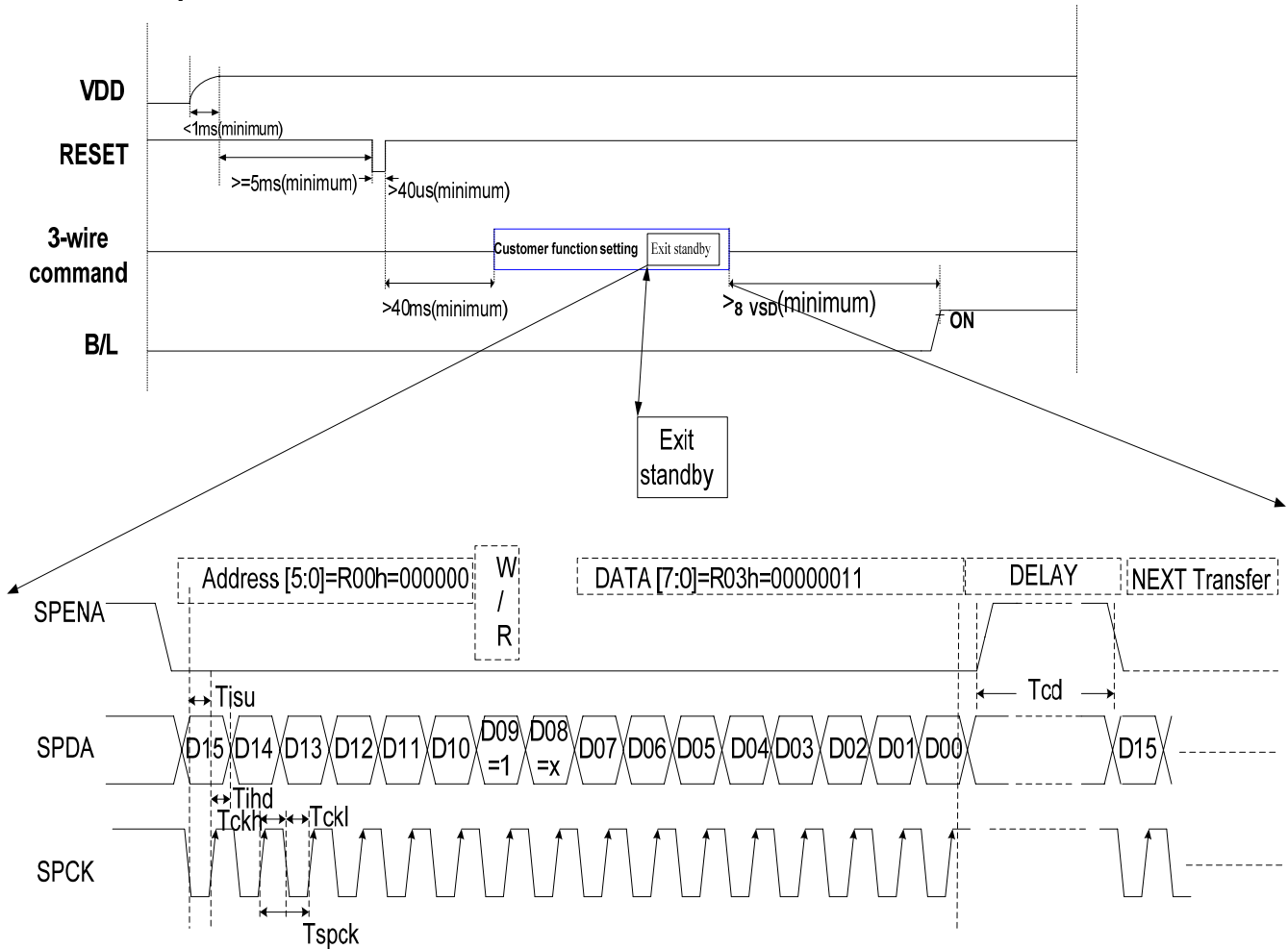

Note

1. Please exit to Standby Mode through 3-wire command, detail sequence that exit to Standby Mode under power on mode presentation as below.
- 2.Exit to standby mode, you can write data “0x03” to register “R00”, D09=1 for writing data to register. D09=0 for reading data from register.

Under SPI write mode,D08=X , and ‘X’ means don’t care D08=‘1’ or ‘0’.

Under SPI write mode,D08=X , and ‘X’ means don’t care D08=‘1’ or ‘0’.

The information contained herein is the exclusive property of SHANGHAI TIANMA MICRO-ELECTRONICS Corporation, and shall not be distributed, reproduced, or disclosed in whole or in part without prior written permission of SHANGHAI TIANMA MICRO-ELECTRONICS Corporation. 889 Huiqing Rd., Pudong New district, Shanghai, China, 201201



## 5.10 Power off Sequence

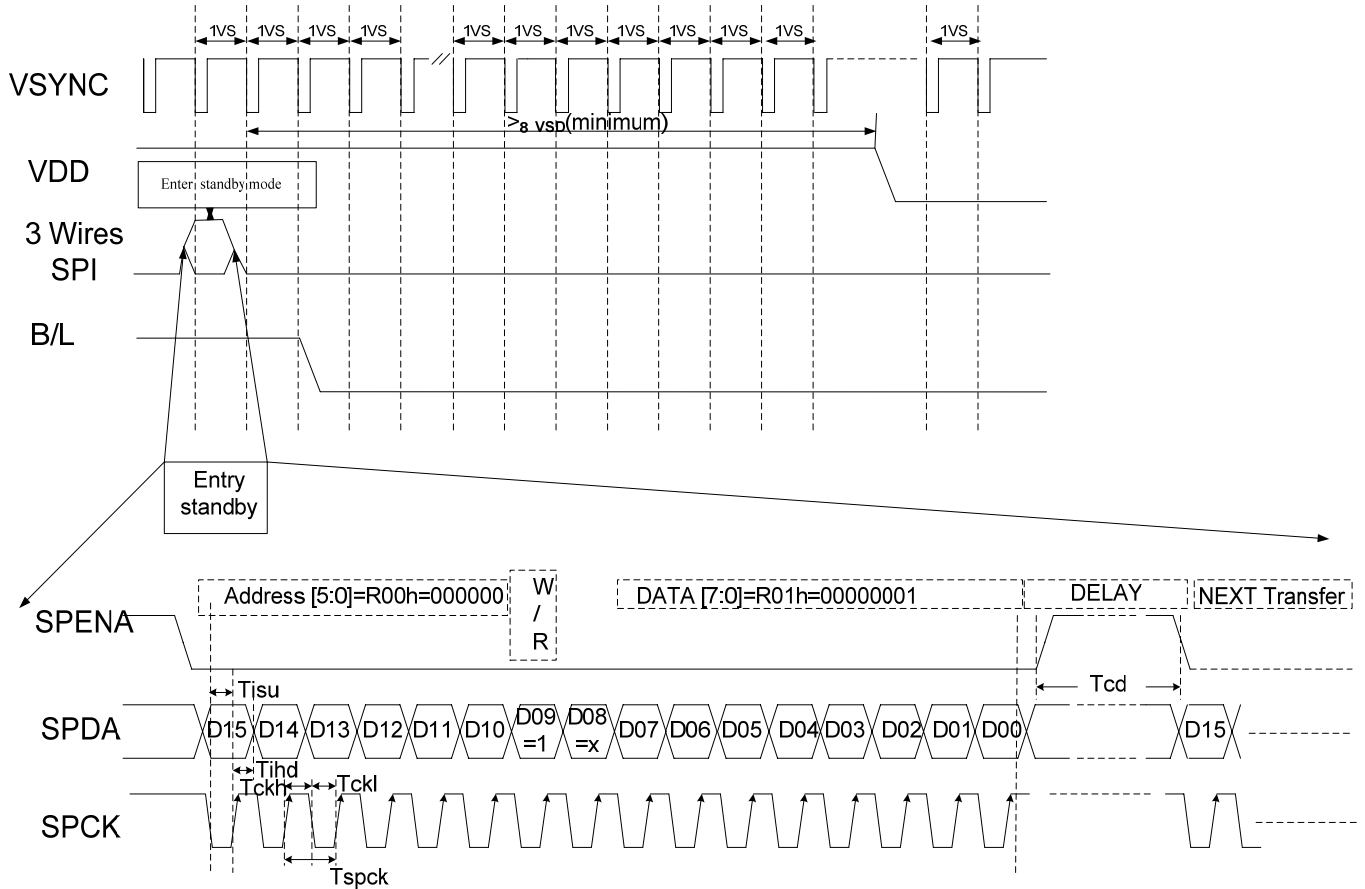

## Note

- 1V<sub>S</sub>=1V<sub>SYNC</sub>. Please enter Standby Mode through 3-wire command, detail sequence which enter Standby Mode under power off mode presentation as below.
- Enter to standby mode, you can write data "0x01" to register "R00", D<sub>09</sub>=1 for writing data to register. D<sub>09</sub>=0 for reading data from register.  
Under SPI write mode, D<sub>08</sub>=X, and 'X' means don't care D<sub>08</sub>'1' or '0'.

The information contained herein is the exclusive property of SHANGHAI TIANMA MICRO-ELECTRONICS Corporation, and shall not be distributed, reproduced, or disclosed in whole or in part without prior written permission of SHANGHAI TIANMA MICRO-ELECTRONICS Corporation. 889 Huiqing Rd., Pudong New district, Shanghai, China, 201201





## 6 Optical Characteristics

Ta=25°C

Item	Symbol	Condition	Min	Typ	Max	Unit	Remark
View Angles	$\theta T$	$CR \geq 10$	40	50	--	Degree	Note 2
	$\theta B$		50	60	--		
	$\theta L$		50	60	--		
	$\theta R$		50	60	--		
Contrast Ratio	CR	$\theta=0^\circ$	250	300	--		Note1 Note3
Response Time	$T_{ON}$	25°C	--	25	40	ms	Note1
	$T_{OFF}$						Note4
Chromaticity	White	x	Backlight is on	0.250	0.300	0.350	Note5 Note1
		y		0.265	0.315	0.365	
	Red	x		0.525	0.575	0.625	
		y		0.270	0.320	0.370	
	Green	x		0.310	0.360	0.410	
		y		0.510	0.560	0.610	
	Blue	x		0.100	0.150	0.200	
		y		0.045	0.095	0.145	
Uniformity	U		75	80	--	%	Note1 Note6
NTSC			--	50	--	%	Note 5
Luminance	L		150	200	--	cd/m <sup>2</sup>	Note1 Note7

Test Conditions:

1.  $V_F = 3.2V$ ,  $I_F = 20mA$ (LED current), the ambient temperature is 25°C.
2. The test systems refer to Note 1 and Note2.

The information contained herein is the exclusive property of SHANGHAI TIANMA MICRO-ELECTRONICS Corporation, and shall not be distributed, reproduced, or disclosed in whole or in part without prior written permission of SHANGHAI TIANMA MICRO-ELECTRONICS Corporation. 889 Huiqing Rd., Pudong New district, Shanghai, China, 201201



Note 1: Definition of optical measurement system.

The optical characteristics should be measured in dark room. After 5 minutes operation, the optical properties are measured at the center point of the LCD screen. All input terminals LCD panel must be ground when measuring the center area of the panel.

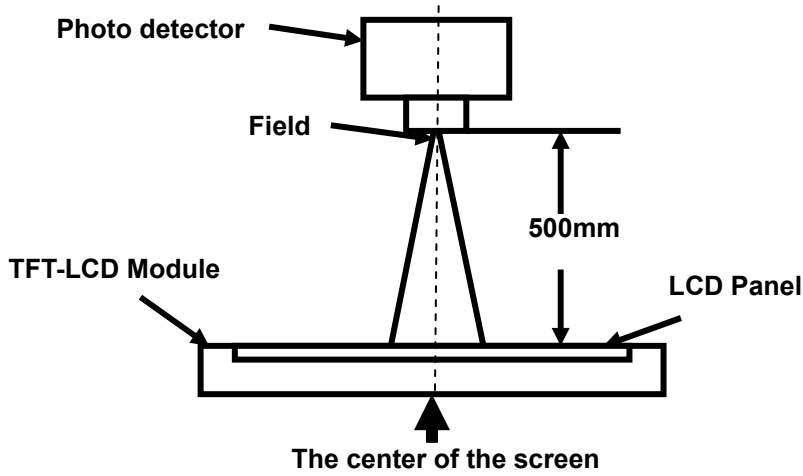

Item	Photo detector	Field
Contrast Ratio	SR-3A	1°
Luminance		
Chromaticity		
Lum Uniformity		
Response Time	BM-7A	2°

Note 2: Definition of viewing angle range and measurement system.

viewing angle is measured at the center point of the LCD by CONOSCOPE(ergo-80).

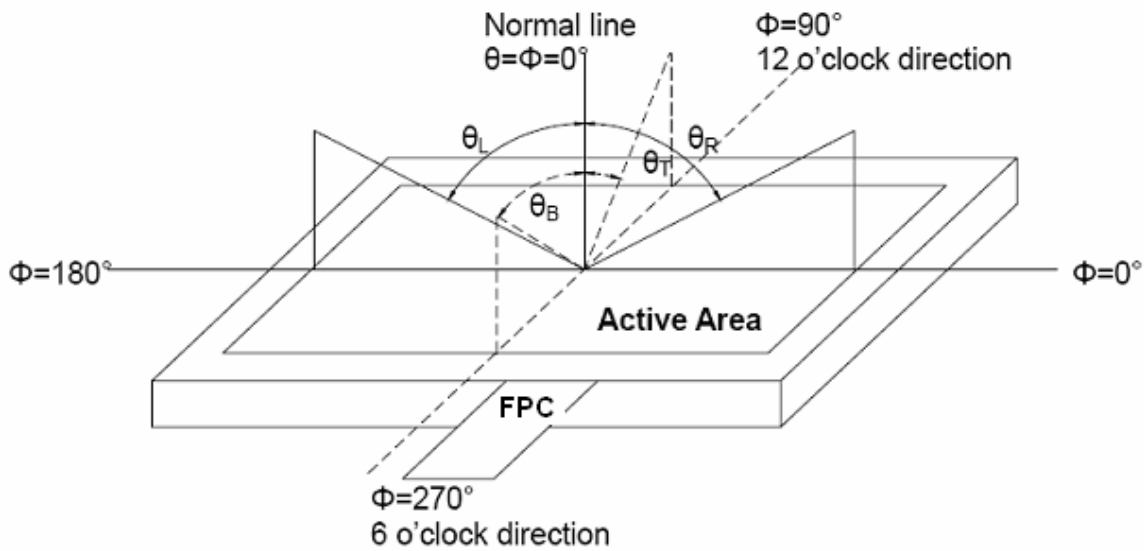

Fig. 1 Definition of viewing angle

Note 3: Definition of contrast ratio

The information contained herein is the exclusive property of SHANGHAI TIANMA MICRO-ELECTRONICS Corporation, and shall not be distributed, reproduced, or disclosed in whole or in part without prior written permission of SHANGHAI TIANMA MICRO-ELECTRONICS Corporation. 889 Huiqing Rd., Pudong New district, Shanghai, China, 201201



$$\text{Contrast ratio (CR)} = \frac{\text{Luminance measured when LCD is on the "White" state}}{\text{Luminance measured when LCD is on the "Black" state}}$$

“White state “:The state is that the LCD should driven by Vwhite.

“Black state”: The state is that the LCD should driven by Vblack.

Vwhite: To be determined    Vblack: To be determined.

Note 4: Definition of Response time

The response time is defined as the LCD optical switching time interval between “White” state and “Black” state. Rise time (TON) is the time between photo detector output intensity changed from 90% to 10%. And fall time (TOFF) is the time between photo detector output intensity changed from 10% to 90%.

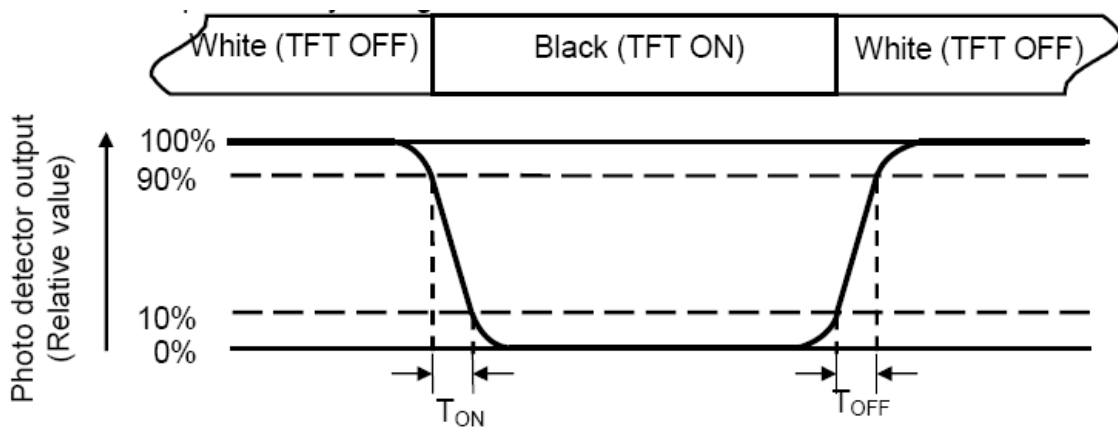

Note 5: Definition of color chromaticity (CIE1931)

Color coordinates measured at center point of LCD.

Note 6: Definition of Luminance Uniformity

Active area is divided into 9 measuring areas (Refer Fig. 2). Every measuring point is placed at the center of each measuring area.

$$\text{Luminance Uniformity}(U) = L_{\min} / L_{\max}$$

L-----Active area length W----- Active area width

The information contained herein is the exclusive property of SHANGHAI TIANMA MICRO-ELECTRONICS Corporation, and shall not be distributed, reproduced, or disclosed in whole or in part without prior written permission of SHANGHAI TIANMA MICRO-ELECTRONICS Corporation. 889 Huiqing Rd., Pudong New district, Shanghai, China, 201201

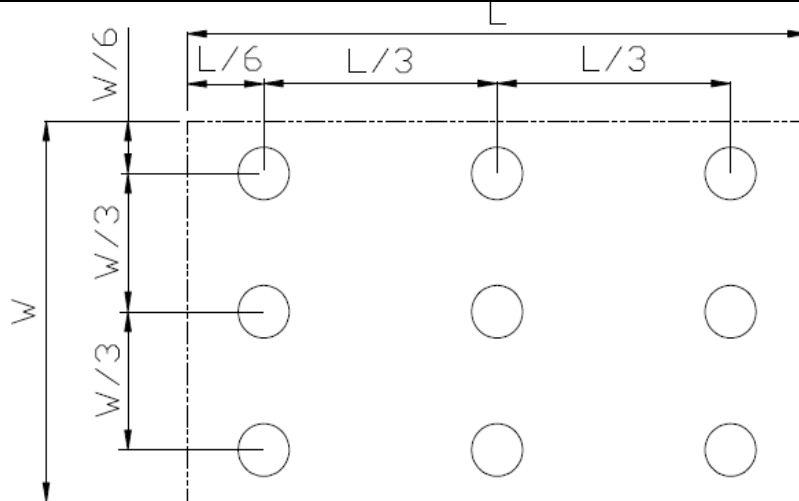

Fig. 2 Definition of uniformity

$L_{max}$ : The measured maximum luminance of all measurement position.

$L_{min}$ : The measured minimum luminance of all measurement position.

Note 7: Definition of Luminance.

Measure the luminance of white state at center point.



## 7 Environmental / Reliability Tests

No	Test Item	Condition	Remarks
1	High Temperature Operation	Ts=+60°C,240hrs	Note1 IEC60068-2-2,GB2423.2—89
2	Low Temperature Operation	Ta=-20°C, 240hrs	IEC60068-2-1 GB2423.1—89
3	High Temperature Storage	Ta=+70°C, 240hrs	IEC60068-2-2, GB2423.2—89
4	Low Temperature Storage	Ta=-30°C, 240hrs	IEC60068-2-1 GB2423.1—89
5	High Temperature & High Humidity Storage	+60°C,90% RH max, 240 hours	Note2 IEC60068-2-3, GB/T2423.3—2006
6	Thermal Shock (Non-operation)	-30°C 30 min~+70°C 30 min, Change time:5min,30 Cycle.	Start with cold temperature, end with high temperature IEC60068-2-14,GB2423.22—87
7	Shock (Non-operation)	60G 6ms,± X,± Y,± Z 3times, for each direction	IEC60068-2-27 GB/T2423.5—1995
8	Package Drop Test	Height:80 cm 1 corner, 3 edges, 6surfaces	IEC60068-2-32 GB/T2423.8—1995

Note1: Ts is the temperature of panel's surface.

Note2: Ta is the ambient temperature of sample.

The information contained herein is the exclusive property of SHANGHAI TIANMA MICRO-ELECTRONICS Corporation, and shall not be distributed, reproduced, or disclosed in whole or in part without prior written permission of SHANGHAI TIANMA MICRO-ELECTRONICS Corporation. 889 Huiqing Rd., Pudong New district, Shanghai, China, 201201

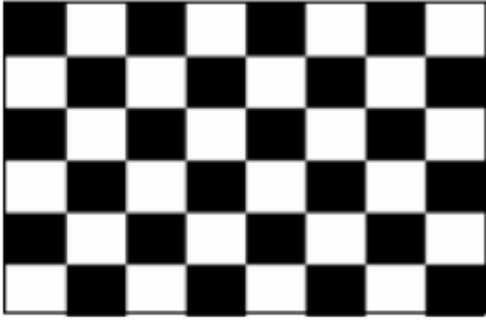

## Cross Pattern

Judgment:

Main LCD should work under the normal condition.

After the temperature and humidity test, the luminance and CR(Contrast Ratio) should not be changed over 50% compared with those before the test.



# 8 Mechanical Drawing

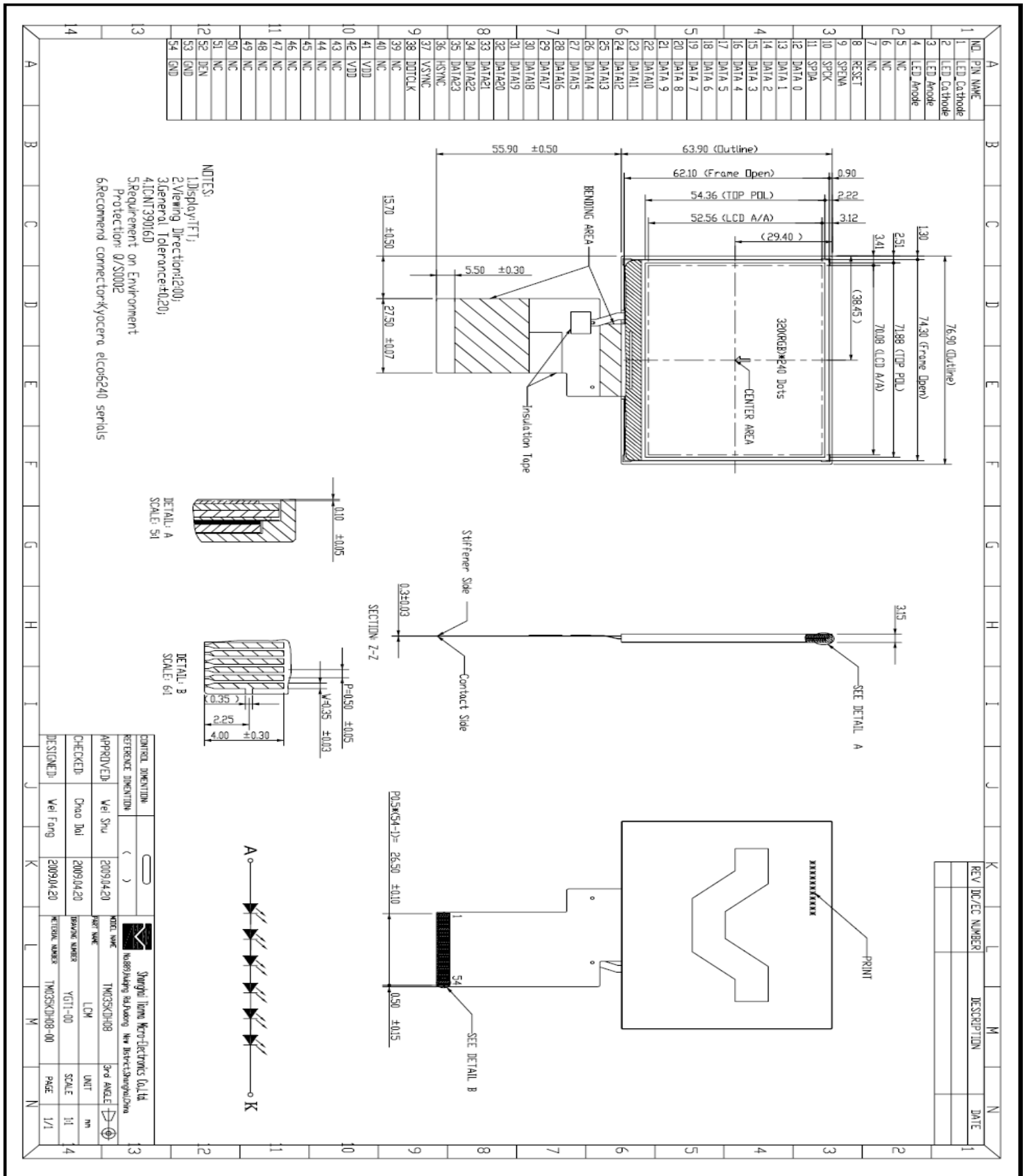

The information contained herein is the exclusive property of SHANGHAI TIANMA MICRO-ELECTRONICS Corporation, and shall not be distributed, reproduced, or disclosed in whole or in part without prior written permission of SHANGHAI TIANMA MICRO-ELECTRONICS Corporation. 889 Huiqing Rd., Pudong New district, Shanghai, China, 201201



### 9 Packing Drawing

No	Item	Model (Material)	Dimension(mm)	Unit Weight(Kg)	Quantity	Remark
1	LCM Module	TM035KDH08	76.9×63.90×3.15	TBD	168	
2	Partition 1	Corrugated Paper	513×333×106	0.782	2	
3	Anti-Static bag	PE	155×85×0.05	0.003	168	
4	Dust-Proof bag	PE	700×545	0.06	1	
5	Partition 2	Corrugated Paper	505×332×4.00	0.095	3	
6	Corrugated Bar	Corrugated Paper	513×117×4	0.32	12	
7	Carton	Corrugated Paper	530×350×250	1.10	1	
8	Total weight(Kg)	(TBD)Kg				

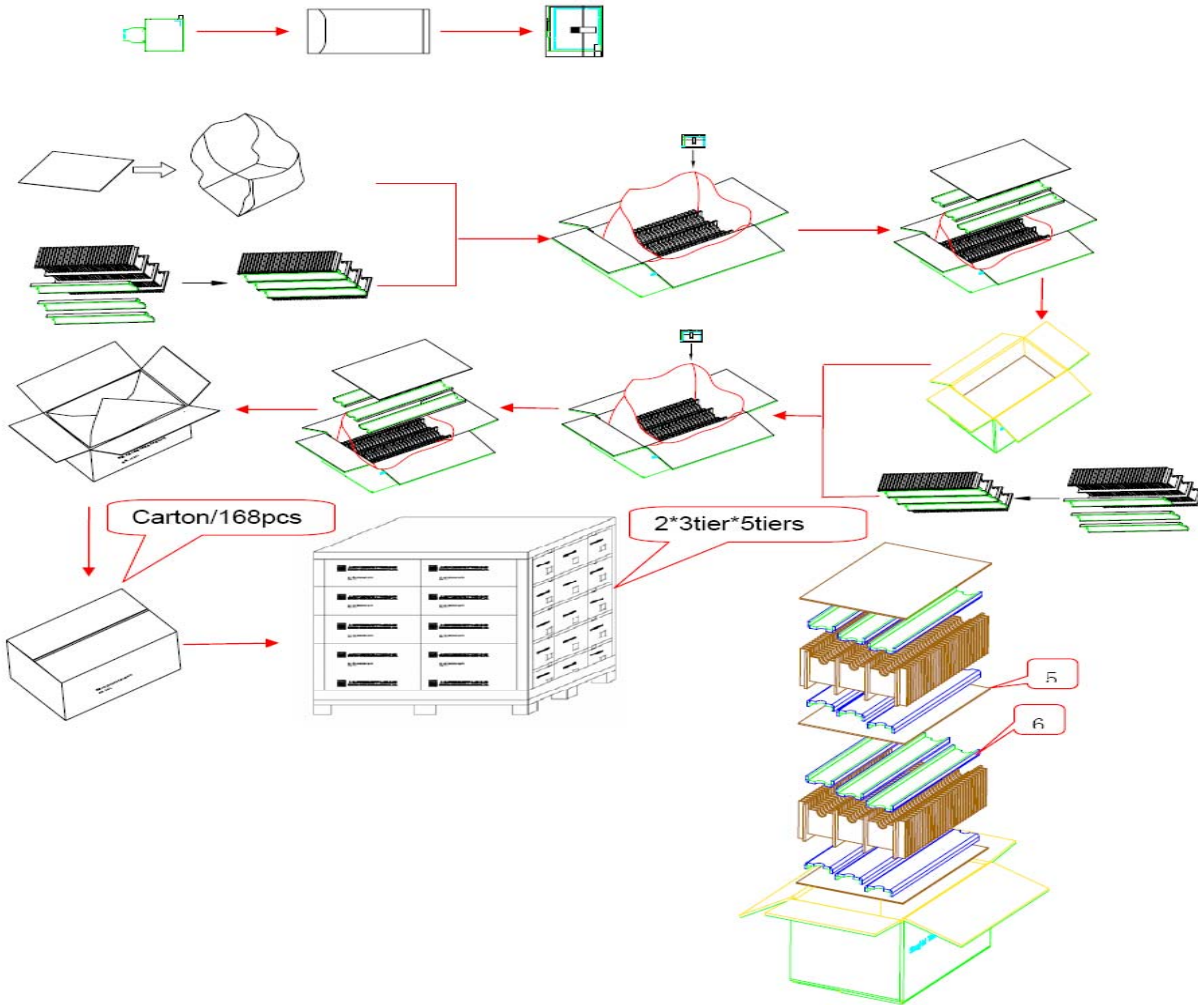

The information contained herein is the exclusive property of SHANGHAI TIANMA MICRO-ELECTRONICS Corporation, and shall not be distributed, reproduced, or disclosed in whole or in part without prior written permission of SHANGHAI TIANMA MICRO-ELECTRONICS Corporation. 889 Huiqing Rd., Pudong New district, Shanghai, China, 201201





## 10 Packing Drawing

### Handling Precautions

The display panel is made of glass. Do not subject it to a mechanical shock by dropping it from a high place, etc.

If the display panel is damaged and the liquid crystal substance inside it leaks out, be sure not to get any in your mouth, if the substance comes into contact with your skin or clothes, promptly wash it off using soap and water.

Do not apply excessive force to the display surface or the adjoining areas since this may cause the color tone to vary.

The polarizer covering the display surface of the LCD module is soft and easily scratched. Handle this polarizer carefully.

If the display surface is contaminated, breathe on the surface and gently wipe it with a soft dry cloth. If still not completely clear, moisten cloth with one of the following solvents:

- Isopropyl alcohol、
- Ethyl alcohol

Solvents other than those mentioned above may damage the polarizer. Especially, do not use the following:

- Water
- Ketone
- Aromatic solvents

Do not attempt to disassemble the LCD Module.

If the logic circuit power is off, do not apply the input signals.

To prevent destruction of the elements by static electricity, be careful to maintain an optimum work environment.

Be sure to ground the body when handling the LCD Modules.

Tools required for assembly, such as soldering irons, must be properly ground.

To reduce the amount of static electricity generated, do not conduct assembly and other work under dry conditions.

The LCD Module is coated with a film to protect the display surface. Be care when peeling off this protective film since static electricity may be generated.

### Storage precautions

When storing the LCD modules, avoid exposure to direct sunlight or to the light of fluorescent lamps.

The LCD modules should be stored under the storage temperature range. If the LCD modules will be stored for a long time, the recommend condition is:

Temperature : 0℃ ~ 40℃      Relatively humidity: ≤80%

The LCD modules should be stored in the room without acid, alkali and harmful gas.

### Transportation Precautions:

The LCD modules should be no falling and violent shocking during transportation, and also should avoid excessive press, water, damp and sunshine.

---

The information contained herein is the exclusive property of SHANGHAI TIANMA MICRO-ELECTRONICS Corporation, and shall not be distributed, reproduced, or disclosed in whole or in part without prior written permission of SHANGHAI TIANMA MICRO-ELECTRONICS Corporation. 889 Huiqing Rd., Pudong New district, Shanghai, China, 201201