

SPECIFICATION FOR LCD MODULE

Model No. TM12864LBC6

Prepared by:	Date:
Checked by :	Date:
Verified by :	Date:
Approved	Date:

TIANMA MICROELECTRONICS CO., LTD

REVISION RECORD

Date	Ref. Page	Revision No.	Revision Items	Check & Approval

1. General Specifications:

- 1.1 Display type: STN
- 1.2 Display color*¹:
 - Display color: Blue-Black
 - Background: Yellow-Green
- 1.3 Polarizer mode: Transflective/Positive
- 1.4 Viewing Angle: 6:00
- 1.5 Driving Method: 1/64 Duty 1/9 Bias
- 1.6 VDD: 5.0V
- 1.7 LCD Operating Voltage: 11.0V
- 1.8 Backlight: LED
- 1.9 Controller: S6B0108A01-C0CX(KS0108BPCC)
- 1.10 Data Transfer: 8 Bit Parallel
- 1.11 Operating Temperature: 0----+50 °C
Storage Temperature: -20----+60 °C
- 1.12 Outline Dimensions: Refer to outline drawing on next page
- 1.13 Dot Matrix: 128 X 64 Dots
- 1.14 Dot Size: 0.48 X 0.48(mm)
- 1.15 Dot Pitch: 0.52 X 0.52(mm)
- 1.16 Weight: 105g

*¹ Color tone is slightly changed by temperature and driving voltage.

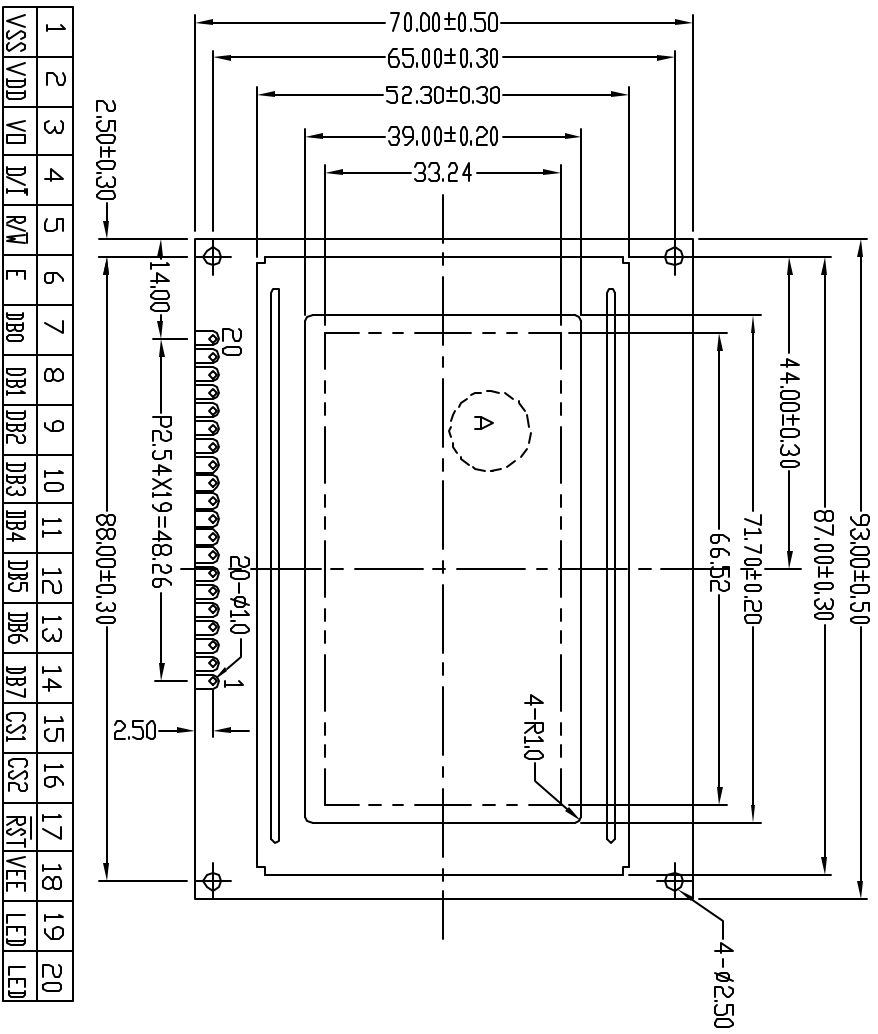

1	2	3	4	5	6	7	8	9	10	11	12	13	14	15	16	17	18	19	20
VSS	VDD	V0	D/I	R/V	E	DB0	DB1	DB2	DB3	DB4	DB5	DB6	DB7	CS1	CS2	RST	VEE	LED	LED

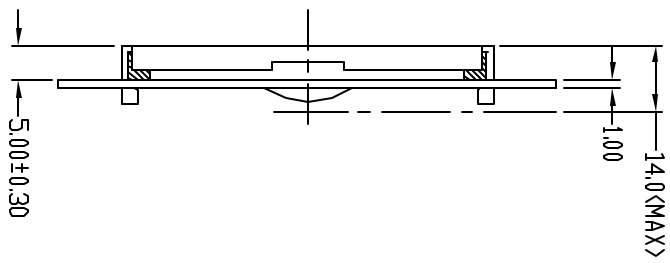

DETAIL A:

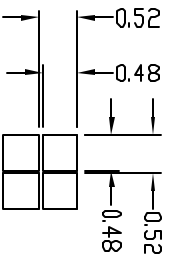

3. LCD Module Part Numbering System

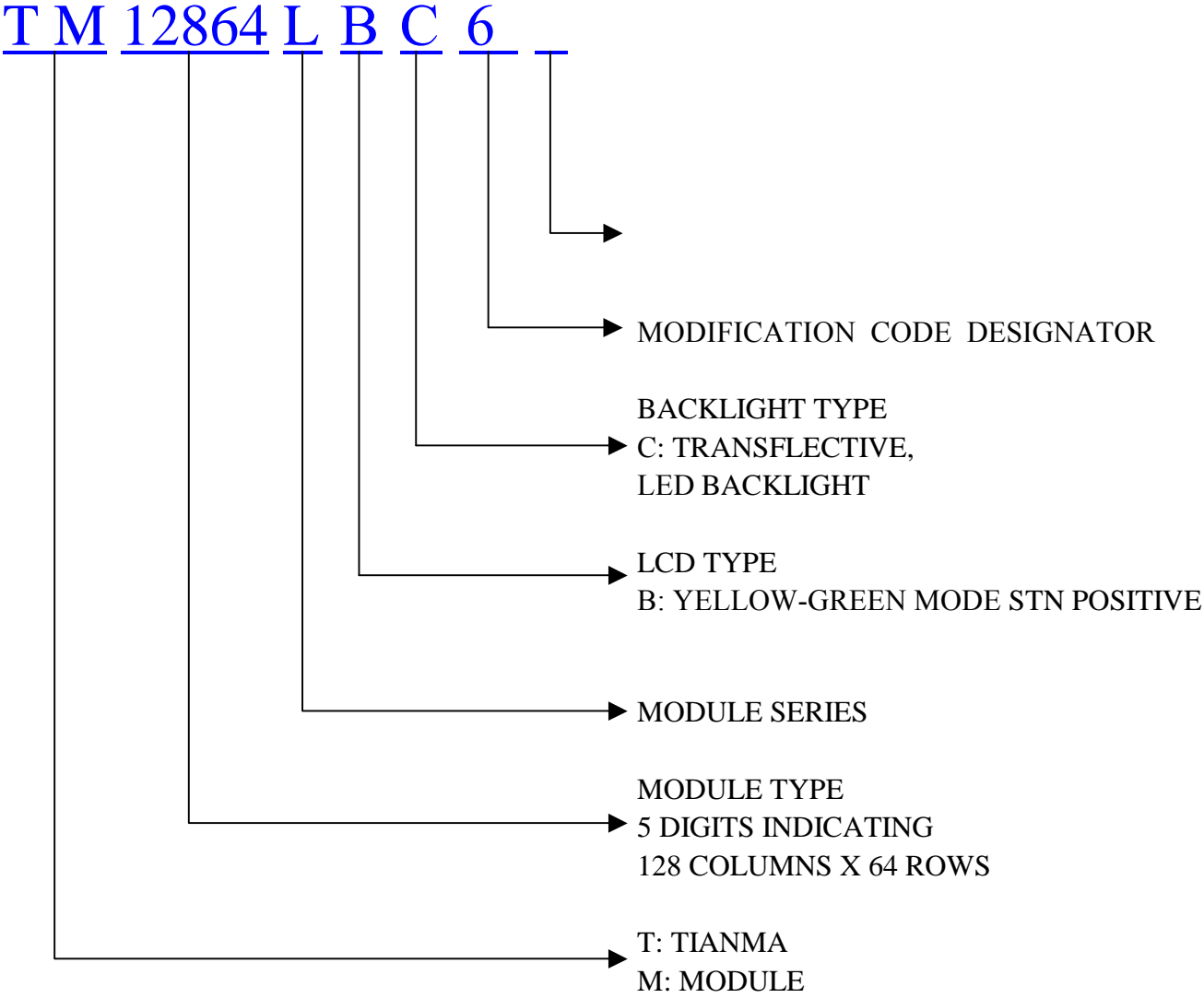

4. Circuit Block Diagram

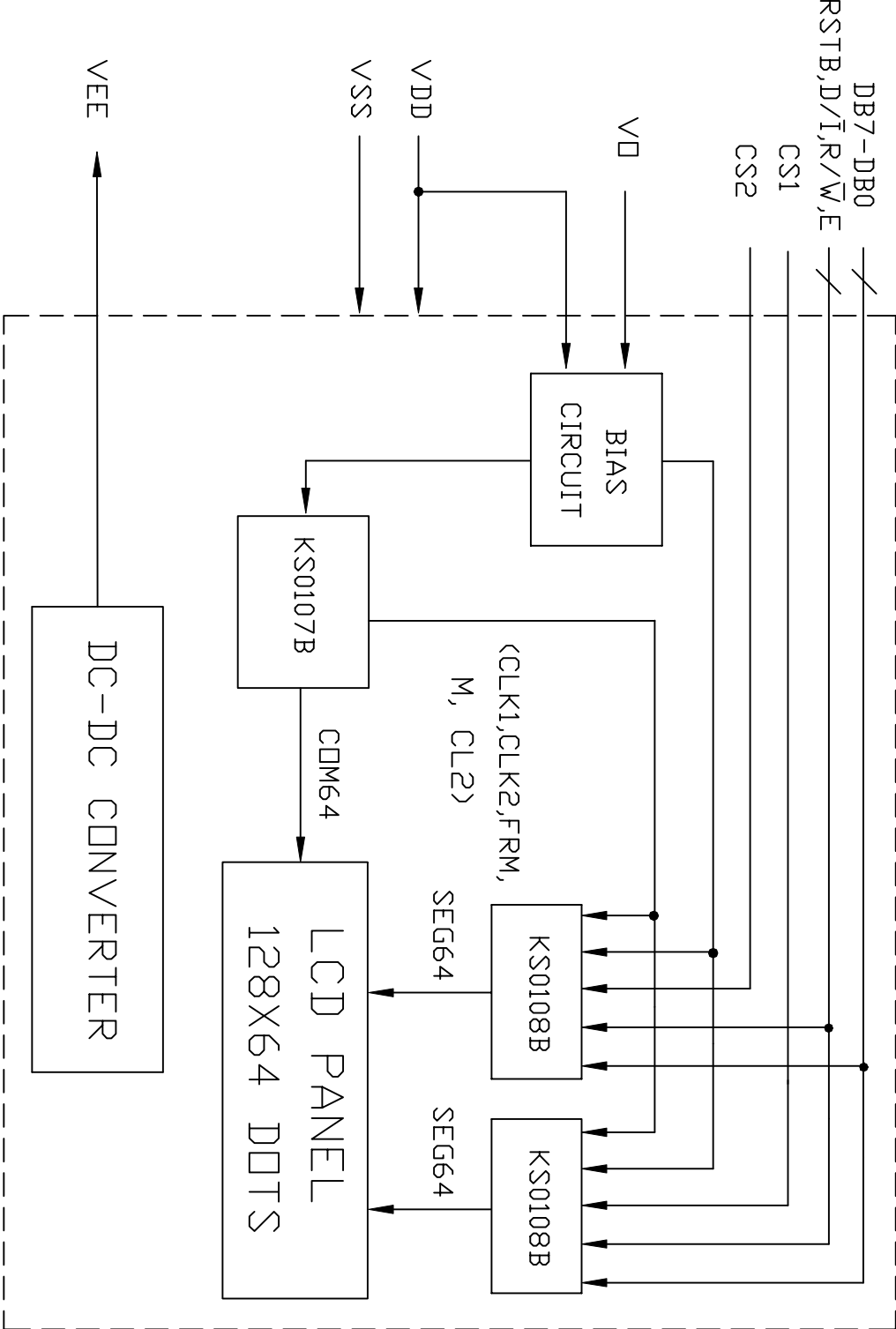

5. Absolute Maximum Ratings

Item	Symbol	Min.	Max.	Unit	Remark
Power Supply Voltage	$V_{DD}-V_{SS}$	-0.3	6.0	V	
LCD Driving Voltage	V_{LCD}	-	25.0		
Operating Temperature Range	T_{OP}	0	+50	°C	No Condensation
Storage Temperature Range	T_{ST}	-20	+60		

6. Electrical Specifications and Instruction Code

6.1 Electrical characteristics

Item	Symbol	Min.	Typ.	Max.	Unit
Supply Voltage (Logic)	$V_{DD}-V_{SS}$	4.75	5.0	5.25	V
Supply Voltage (LCD Drive)	$V_{DD}-V_O$	-	11.0	-	V
Input Signal Voltage	High V_{IH} ($V_{DD}=5.0$)	$0.8V_{DD}$	-	$V_{DD}+0.3$	V
	Low V_{IL} ($V_{DD}=5.0$)	0	-	$0.2 V_{DD}$	V
Supply current (Logic)	I_{DD}	-	2.5	-	mA
Supply current (LCD Drive)	I_{EE}	-	1.2	-	mA
Supply current (LED)	I_{LED}	-	-	150	mA

6.2 Interface Signals

Pin No.	Symbol	Level	Description
1	V_{SS}	0V	Ground
2	V_{DD}	5.0V	Supply voltage for logic and LCD(+)
3	V_o	-	Operating voltage for LCD(-)(variable)
4	D/\bar{I}	H/L	H:Data;L:Instruction code
5	$\bar{R/W}$	H/L	Selects read or write
6	E	H/L	Enable Input
7	DB0	H/L	Data bit0
8	DB1	H/L	Data bit1
9	DB2	H/L	Data bit2
10	DB3	H/L	Data bit3
11	DB4	H/L	Data bit4
12	DB5	H/L	Data bit5
13	DB6	H/L	Data bit6
14	DB7	H/L	Data bit7
15	CS1	L	Chip Select Signal 1
16	CS2	L	Chip Select Signal 2
17	\bar{RST}	L	Reset Signal
18	V_{EE}	-	Negative Voltage for LCD driving
19	LED1	-	Power supply for LED Backlight
20	LED2	-	Power supply for LED Backlight

6.3 Interface Timing Chart

MPU Interface

Characteristic	Symbol	Min	Typ	Max	Unit
E Cycle	t_c	1000	-	-	ns
E High Level Width	t_{WH}	450	-	-	ns
E Low Level Width	t_{WL}	450	-	-	ns
E Rise Time	t_R	-	-	25	ns
E Fall Time	t_F	-	-	25	ns
Address Set-Up Time	t_{ASU}	140	-	-	ns
Address Hold Time	t_{AH}	10	-	-	ns
Data Set-Up Time	t_{DSU}	200	-	-	ns
Data Delay Time	t_D	-	-	320	ns
Data Hold Time (Write)	t_{DHW}	10	-	-	ns
Data Hold Time (Read)	t_{DHR}	20	-	-	ns

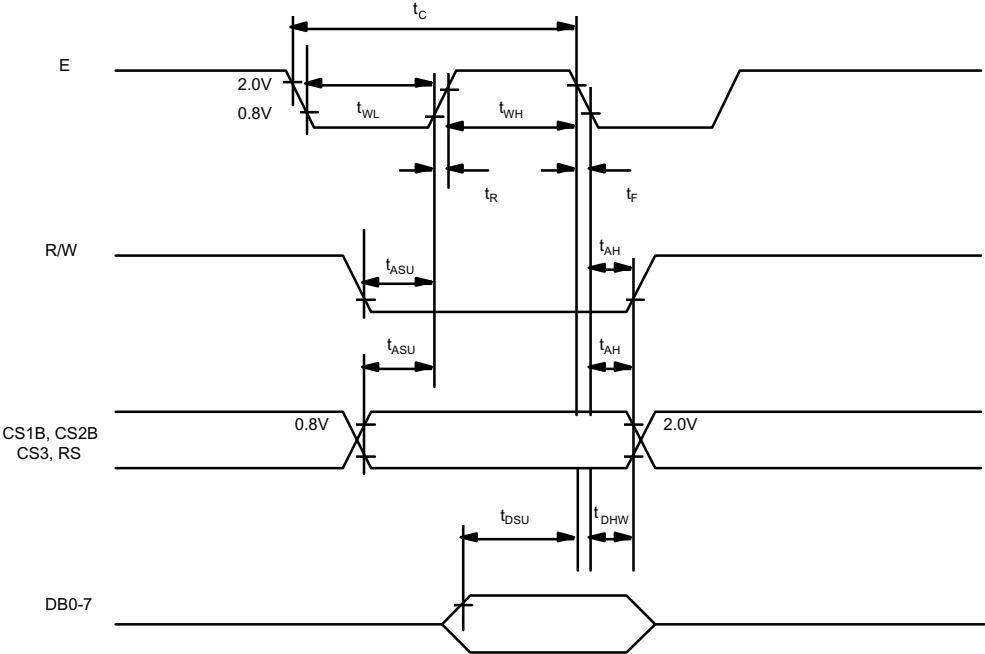

Fig 1. MPU write timing

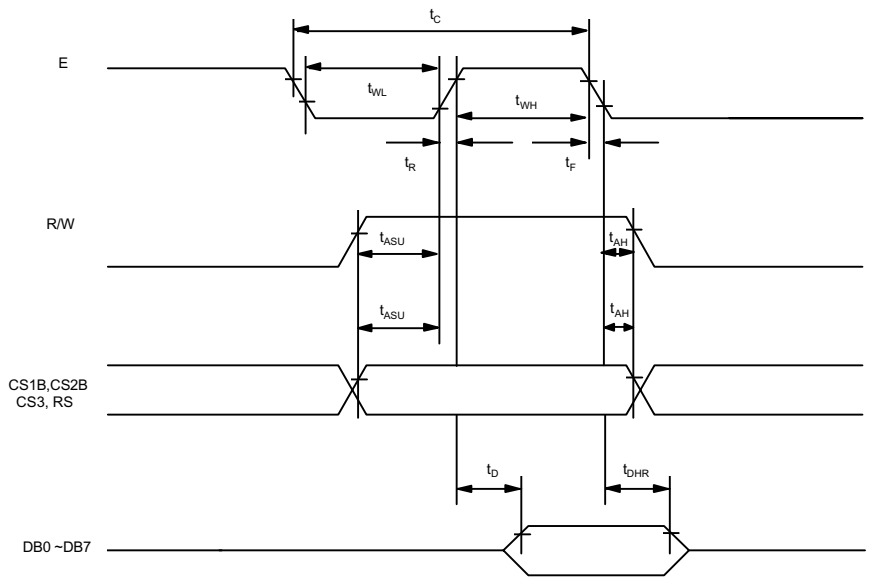

Fig 2. MPU Read timing

6.4 Instruction Code

The display control instructions control the internal state of the KS0108B. Instruction is received from MPU to KS0108B for the display control. The following table shows various instructions.

Instruction	RS	R/W	DB7	DB6	DB5	DB4	DB3	DB2	DB1	DB0	Function	
Display ON/OFF	L	L	L	L	H	H	H	H	H	L/H	Controls the display on or off. Internal status and display RAM data is not affected. L:OFF, H:ON	
Set Address (Y address)	L	L	L	H	Y address (0~63)						Sets the Y address in the Y address counter.	
Set Page (X address)	L	L	H	L	H	H	H	Page (0~7)			Sets the X address at the X address register.	
Display Start Line (Z address)	L	L	H	H	Display start line (0~63)						Indicates the display data RAM displayed at the top of the screen.	
Status Read	L	H	B U S Y	L	O N / O F F	R E S E T	L	L	L	L	Read status. BUSY L: Ready H: In operation ON/OFF L: Display ON H: Display OFF RESET L: Normal H: Reset	
Write Display Data	H	L	Write Data									Writes data (DB0:7) into display data RAM. After writing instruction, Y address is increased by 1 automatically.
Read Display Data	H	H	Read Data									Reads data (DB0:7) from display data RAM to the data bus.

7. Optical Characteristics

7.1 Optical Characteristics

Ta=25°C

Item	Symbol	Condition	Min.	Typ.	Max.	Unit	
Viewing Angle	θ_x	$C_r \geq 2$	$\theta_y = 0^\circ$	-30	--	20	Deg
	θ_y			$\theta_x = 0^\circ$	-30	--	
Contrast Ratio	C_r	$\theta_x = 0^\circ$ $\theta_y = 0^\circ$	3.0		-	-	
Response Time	Turn on	T_{on}	$\theta_x = 0^\circ$ $\theta_y = 0^\circ$	-	-	300	ms
	Turn off	T_{off}		-	-	300	

7.2 Definition of Optical Characteristics

7.2.1 Definition of Viewing Angle

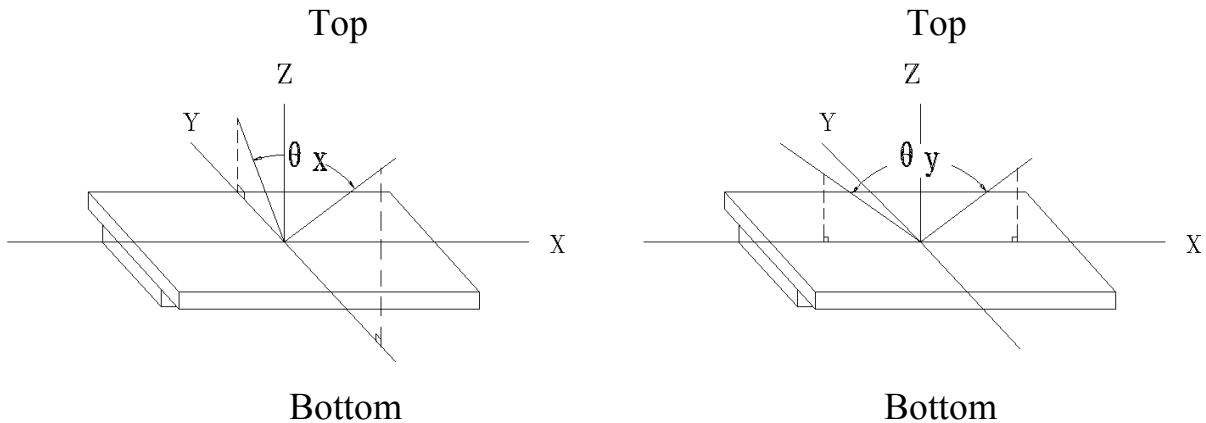

7.2.2 Definition of Contrast Ratio

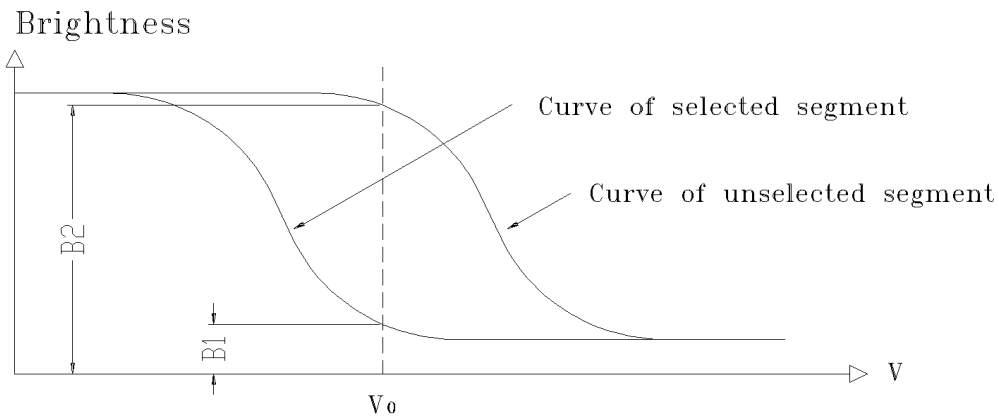

$$\text{Contrast Ratio} = B2/B1 = \frac{\text{unselected state brightness}}{\text{selected state brightness}}$$

Measuring Conditions:

- 1) Ambient Temperature: 25°C ;
- 2) Frame frequency: 64Hz

7.2.3 Definition of Response time

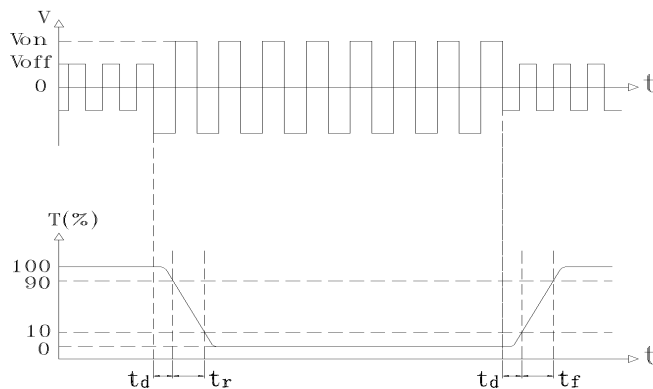

Turn on time: $t_{on} = t_d + t_r$ Turn off time: $t_{off} = t_d + t_f$

Measuring Condition:

- 1) Operating Voltage: 11.0V
- 2) Frame frequency: 64Hz

8. Reliability

8.1 Content of Reliability Test

Ta=25°C

No.	Test Item	Content of Test	Test condition
1	High Temperature Storage	Endurance test applying the high storage temperature for a long time	60°C 240H
2	Low Temperature Storage	Endurance test applying the low storage temperature for a long time	-20°C 240H
3	High Temperature Operation	Endurance test applying the electric stress (voltage & current) and the thermal stress to the element for a long time	50°C 240H
4	Low Temperature Operation	Endurance test applying the electric stress under low temperature for a long time	0°C 240H
5	High Temperature /Humidity Storage	Endurance test applying the high temperature and high humidity storage for a long time	60°C 95%RH 240H
6	Temperature Cycle	Endurance test applying the low and high temperature cycle $-30^{\circ}\text{C} \longleftrightarrow 25^{\circ}\text{C} \longleftrightarrow 80^{\circ}\text{C} \longleftrightarrow 25^{\circ}\text{C}$ $\begin{array}{cccc} 30\text{min} & 5\text{min} & 30\text{min} & 5\text{min} \end{array}$	-30°C/80°C 10 cycles
7	Vibration Test (package state)	Endurance test applying the vibration during transportation	10Hz~500Hz, 100m/s ² , 120min
8	Shock Test (package state)	Endurance test applying the shock during transportation	Half- sine wave, 300m/s ² , 18ms
9	Atmospheric Pressure Test	Endurance test applying the atmospheric pressure during transportation by air	25kPa 16H

8.2 Failure Judgment Criterion

Criterion Item	Test Item No.									Failure Judgement Criterion
	1	2	3	4	5	6	7	8	9	
Basic Specification	√	√	√	√	√	√	√	√	√	Out of the basic Specification
Electrical specification	√	√	√	√	√					Out of the electrical specification
Mechanical Specification							√	√		Out of the mechanical specification
Optical Characteristic	√	√	√	√	√	√			√	Out of the optical specification
Note	For test item refer to 8.1									
Remark	Basic specification = Optical specification + Mechanical specification									

9. QUALITY LEVEL

Examination or Test	At $T_a=25^\circ\text{C}$ (unless otherwise stated)	Inspection				
		Min.	Max.	Unit	IL	AQL
External Visual Inspection	Under normal illumination and eyesight condition, the distance between eyes and LCD is 25cm.	See Appendix A			II	Major 1.0 Minor 2.5
Display Defects	Under normal illumination and eyesight condition, display on inspection.	See Appendix B			II	Major 1.0 Minor 2.5
Note: Major defects: Open segment or common, Short, Serious damages, Leakage Miner defects: Others Sampling standard conforms to GB2828						

10. Precautions for Use of LCD Modules

10.1 Handling Precautions

10.1.1 The display panel is made of glass. Do not subject it to a mechanical shock by dropping it from a high place, etc.

10.1.2 If the display panel is damaged and the liquid crystal substance inside it leaks out, be sure not to get any in your mouth, if the substance comes into contact with your skin or clothes, promptly wash it off using soap and water.

10.1.3 Do not apply excessive force to the display surface or the adjoining areas since this may cause the color tone to vary.

10.1.4 The polarizer covering the display surface of the LCD module is soft and easily scratched. Handle this polarizer carefully.

10.1.5 If the display surface is contaminated, breathe on the surface and gently wipe it with a soft dry cloth. If still not completely clear, moisten cloth with one of the following solvents:

- Isopropyl alcohol
- Ethyl alcohol

Solvents other than those mentioned above may damage the polarizer. Especially, do not use the following:

- Water
- Ketone
- Aromatic solvents

10.1.6 Do not attempt to disassemble the LCD Module.

10.1.7 If the logic circuit power is off, do not apply the input signals.

10.1.8 To prevent destruction of the elements by static electricity, be careful to maintain an optimum work environment.

- a. Be sure to ground the body when handling the LCD Modules.
- b. Tools required for assembly, such as soldering irons, must be properly ground.
- c. To reduce the amount of static electricity generated, do not conduct assembly and other work under dry conditions.
- d. The LCD Module is coated with a film to protect the display surface. Be care when peeling off this protective film since static electricity may be generated.

10.2 Storage precautions

10.2.1 When storing the LCD modules, avoid exposure to direct sunlight or to the light of fluorescent lamps.

10.2.2 The LCD modules should be stored under the storage temperature range. If the LCD modules will be stored for a long time, the recommend condition is:

Temperature : $0^{\circ}\text{C} \sim 40^{\circ}\text{C}$

Relatively humidity: $\leq 80\%$

10.2.3 The LCD modules should be stored in the room without acid, alkali and harmful gas.

10.3 The LCD modules should be no falling and violent shocking during transportation, and also should avoid excessive press, water, damp and sunshine.

Appendix A

Inspection items and criteria for appearance defects

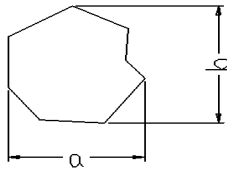
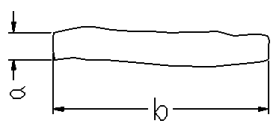
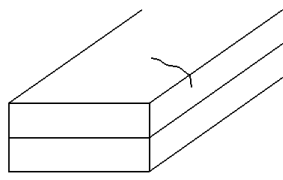
Items	Contents	Criteria			
Leakage		Not permitted			
Rainbow		According to the limit specimen			
Polarizer	Wrong polarizer attachment	Not permitted			
	Bubble between polarizer and glass	Not counted	Max. 3 defects allowed		
		$\phi < 0.3\text{mm}$	$0.3\text{mm} \leq \phi \leq 0.5\text{mm}$		
	Scratches of polarizer	According to the limit specimen			
Black spot (in viewing area)		Not counted	Max. 3 spots allowed	Max. 3 spots (lines) allowed	
		$X < 0.2\text{mm}$	$0.2\text{mm} \leq X \leq 0.5\text{mm}$		
		$X = (a+b)/2$			
Black line (in viewing area)		Not counted	Max. 3 lines allowed		
		$a < 0.02\text{mm}$	$0.02\text{mm} \leq a \leq 0.05\text{mm}$ $b \leq 2.0\text{mm}$		
Progressive cracks		Not permitted			

Appendix B

Inspection items and criteria for display defects

Items	Contents	Criteria		
Open segment or open common		Not permitted		
Short		Not permitted		
Wrong viewing angle		Not permitted		
Contrast ratio uneven		According to the limit specimen		
Crosstalk		According to the limit specimen		
Pin holes and cracks in segment (DOT)		Not counted	Max.3 dots allowed	Max.3 dots allowed
		$X < 0.1\text{mm}$	$0.1\text{mm} \leq X \leq 0.2\text{mm}$	
		$X = (a+b)/2$		
		Not counted	Max.2 dots allowed	
$A < 0.1\text{mm}$		$0.1\text{mm} \leq A \leq 0.2\text{mm}$ $D < 0.25\text{mm}$		
Black spot (in viewing area)		Not counted	Max.3 spots allowed	Max.3 spots (lines) allowed
		$X < 0.1\text{mm}$	$0.1\text{mm} \leq X \leq 0.2\text{mm}$	
		$X = (a+b)/2$		
Black line (in viewing area)		Not counted	Max.3 lines allowed	
		$a < 0.02\text{mm}$	$0.02\text{mm} \leq a \leq 0.05\text{mm}$ $b \leq 0.5\text{mm}$	

Appendix B

Inspection items and criteria for display defects (continued)

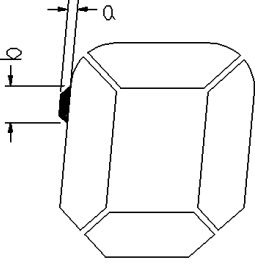
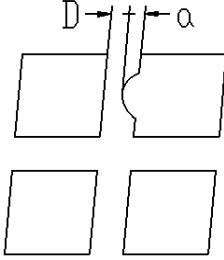
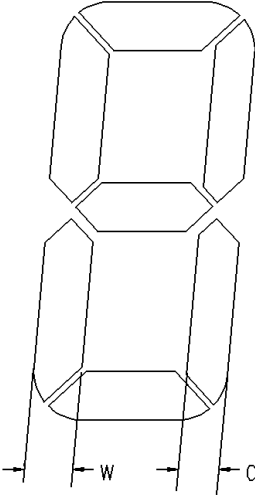
Items	Content	Criteria			
Transformation of segment		Not counted	Max. 2 defects allowed	Max.3 defects allowed	
		$x < 0.1\text{mm}$	$0.1\text{mm} \leq x \leq 0.2\text{mm}$		
		$x = (a+b)/2$			
		Not counted	Max. 1 defects allowed		
		$a < 0.1\text{mm}$	$0.1\text{mm} \leq a \leq 0.2\text{mm}$ $D > 0$		
		<p>Max.2 defects allowed</p> <p>$0.8W \leq a \leq 1.2W$</p> <p>a=measured value of width W=nominal value of width</p>			