

SPECIFICATION FOR LCD MODULE

Model No. TM164ABAG

Prepared by:	Date:
Checked by :	Date:
Verified by :	Date:
Approved by:	Date:

TIANMA MICROELECTRONICS CO., LTD

REVISION RECORD

Date	Ver.	Ref. Page	Revision No.	Revision Item

1. General Specifications:

1.1 Display type:	STN/Y-G MODE
1.2 Display color*:	
Display color:	Blue-Black
Background:	Yellow-Green
1.3 Polarizer mode:	Reflective/Positive
1.4 Viewing Angle:	6:00
1.5 Driving Method:	1/34 Duty 1/5 Bias
1.6 Lcd operating voltage:	5.0V
1.7 Without Backlight	
1.8 Controller:	S6A0094X01-B0CY
1.9 Data Transfer:	8 Bit Parallel
1.10 Operating Temperature:	0°C----+50°C
Storage Temperature:	-20°C----+60°C
1.11 Outline Dimensions:	Refer to outline drawing on next page
1.12 Dot Matrix:	16 Characters X 4 Lines
1.13 Dot Size:	0.55X0.55(mm)
1.14 Dot Pitch:	0.60X0.60 (mm)
1.15 Weight:	50g (Approx)

*Color tone is slightly changed by temperature and driving voltage.

2. Outline Drawing

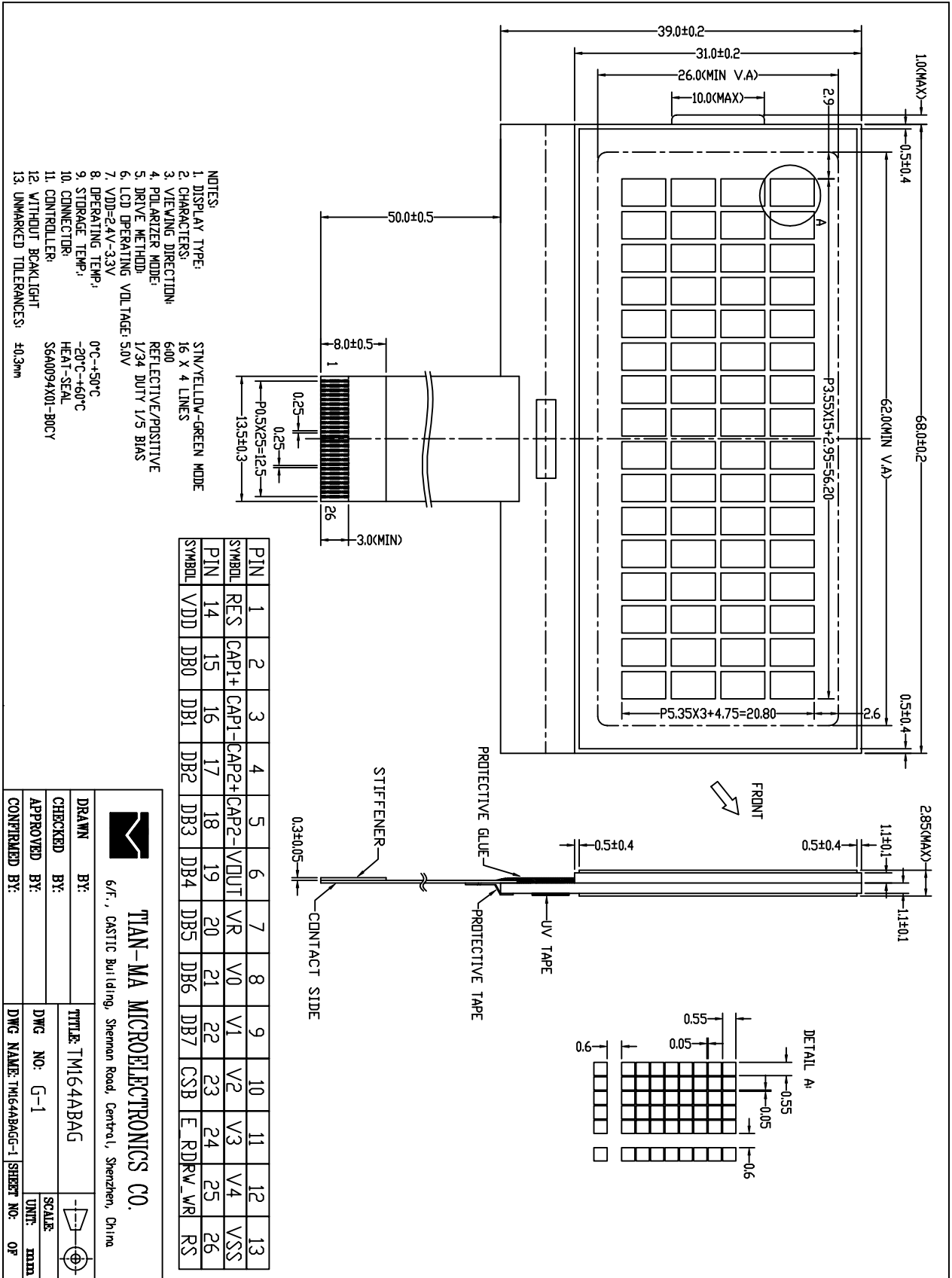

3. LCD Module Part Numbering System

T M 164 A B A G

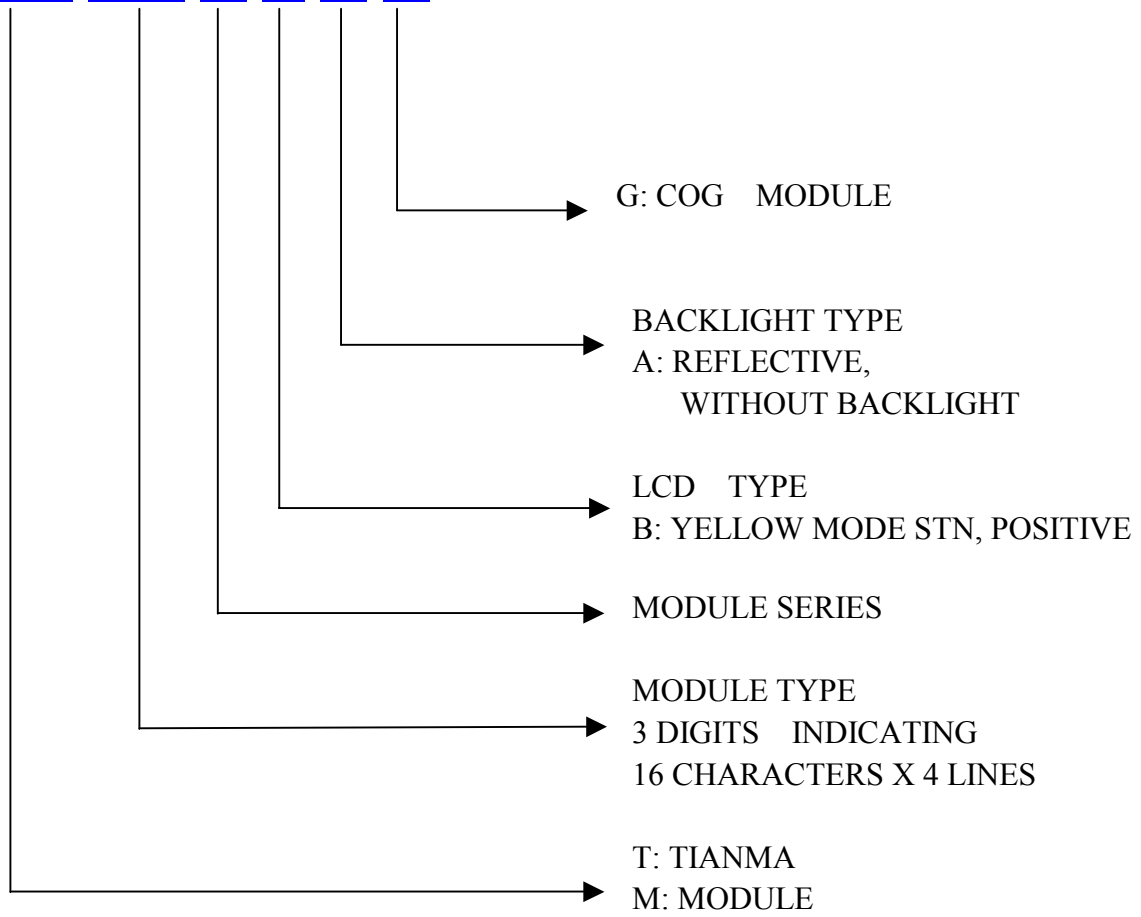

4. Circuit Block Diagram

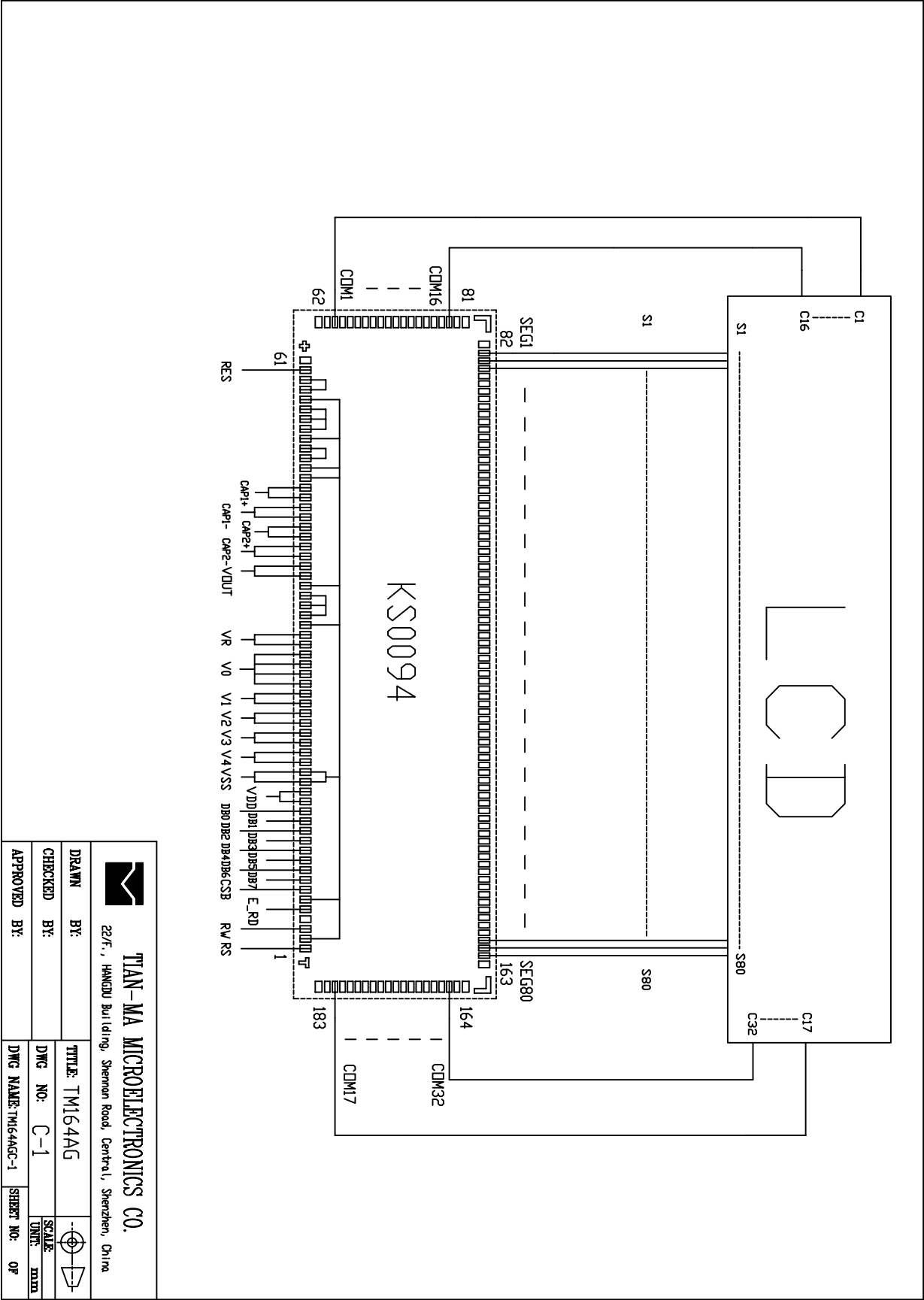

5. Absolute Maximum Ratings

Item	Symbol	Min.	Max.	Unit	Remark
Power Supply Voltage	$V_{DD}-V_{SS}$	-0.3	6.0	V	
LCD Driving Voltage	V_{LCD}	-	25.0		
Operating Temperature Range	T_{OP}	0	+50	°C	No Condensation
Storage Temperature Range	T_{ST}	-20	+60		

6. Electrical Specifications and Instruction Code

6.1 Electrical characteristics

Item		Symbol	Min.	Typ.	Max.	Unit
Supply Voltage (Logic)		$V_{DD}-V_{SS}$	2.4	3.0	3.3	V
Supply Voltage (LCD Drive)		V_{LCD}	-	5.0	-	V
Input Signal Voltage	High	V_{IH} ($V_{DD}=5.0$)	$0.8V_{DD}$	-	$V_{DD}+0.3$	V
	Low	V_{IL} ($V_{DD}=5.0$)	0	-	$0.2V_{DD}$	V
Supply current (Logic)		I_{DD}	-	-	1.0	mA
Supply current (LCD Drive)		I_{EE}	-	-	0.5	mA

6.2 Interface Signals

Pin No.	Symbol	Level	Description
1	RES	H/L	Reset Input
2	CAP1+	-	Capacitor+ Connecting Pin for Internal Voltage Converter
3	CAP1-	-	Capacitor- Connecting Pin for Internal Voltage Converter
4	CAP2+	-	Capacitor+ Connecting Pin for Internal Voltage Converter
5	CAP2-	-	Capacitor- Connecting Pin for Internal Voltage Converter
6	VOUT	I/O	DC/DC Voltage Converter Output
7	VR	I	Voltage Adjust Pin
8	V0	I/O	Bias Voltage Level for LCD Driving
9	V1	I/O	Bias Voltage Level for LCD Driving
10	V2	I/O	Bias Voltage Level for LCD Driving
11	V3	I/O	Bias Voltage Level for LCD Driving
12	V4	I/O	Bias Voltage Level for LCD Driving
13	VSS	0V	GND
14	VDD	3.0V	Power Supply
15	DB0	H/L	Data Bit0
16	DB1	H/L	Data Bit1
17	DB2	H/L	Data Bit2
18	DB3	H/L	Data Bit3
19	DB4	H/L	Data Bit4
20	DB5	H/L	Data Bit5
21	DB6	H/L	Data Bit6
22	DB7	H/L	Data Bit7
23	CSB	I	Chip Selection Input
24	E_RD	I	Enable Read or Write Pin
25	RW_WR	I	Read or Write Signal Input
26	RS	I	Register Selection Input

6.3 Interface Timing Chart

Parallel Write Interface (68 Mode)

(VDD = 2.2V to 3.6V, Ta = -30 to +85 °C)

Characteristic	Symbol	Min.	Typ.	Max.	Unit
E_RD cycle time	t _c	650	-	-	ns
Pulse rise / fall time	t _R ,t _F	-	-	25	
E_RD pulse width high	t _{WH}	450	-	-	
E_RD pulse width low	t _{WL}	150	-	-	
RS and CSB setup time	t _{SU1}	60	-	-	
RS and CSB hold time	t _{H1}	30	-	-	
DB setup time	t _{SU2}	100	-	-	
DB hold time	t _{H2}	50	-	-	

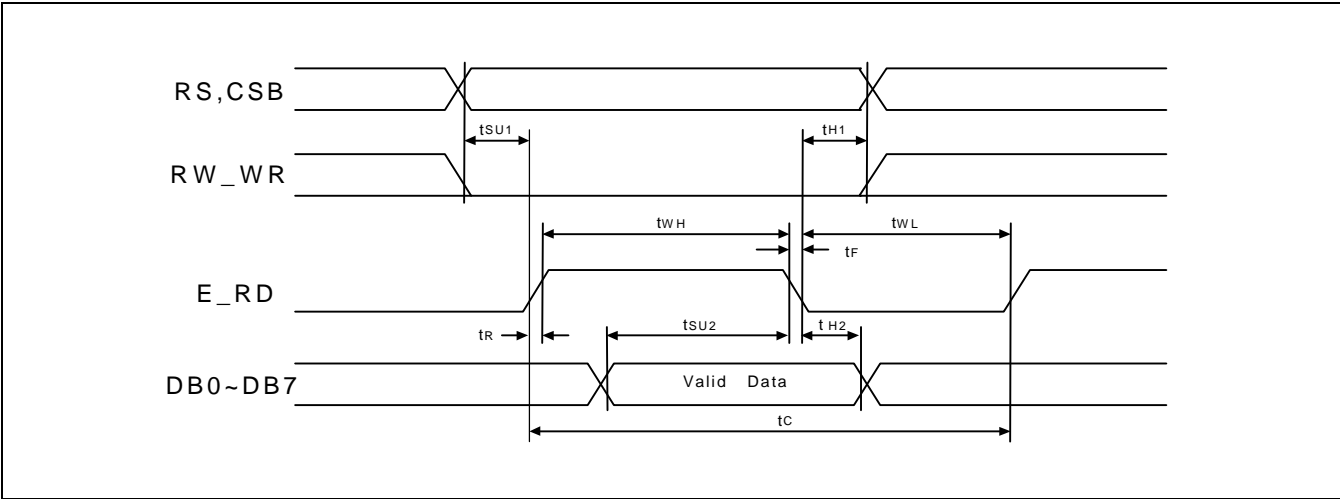

Write Timing Diagram (68-series)

Parallel Read Interface (68 Mode)

(V_{DD} = 2.2V to 3.6V, T_a = -30 to +85 °C)

Characteristic	Symbol	Min.	Typ.	Max.	Unit
E_RD cycle time	t _C	650	-	-	ns
Pulse rise / fall time	t _R ,t _F	-	-	25	
E_RD pulse width high	t _{WH}	450	-	-	
E_RD pulse width low	t _{WL}	150	-	-	
RS and CSB setup time	t _{SU}	60	-	-	
RS and CSB hold time	t _H	30	-	-	
DB output delay time	t _D	100	-	-	
DB output hold time	t _{DH}	50	-	-	

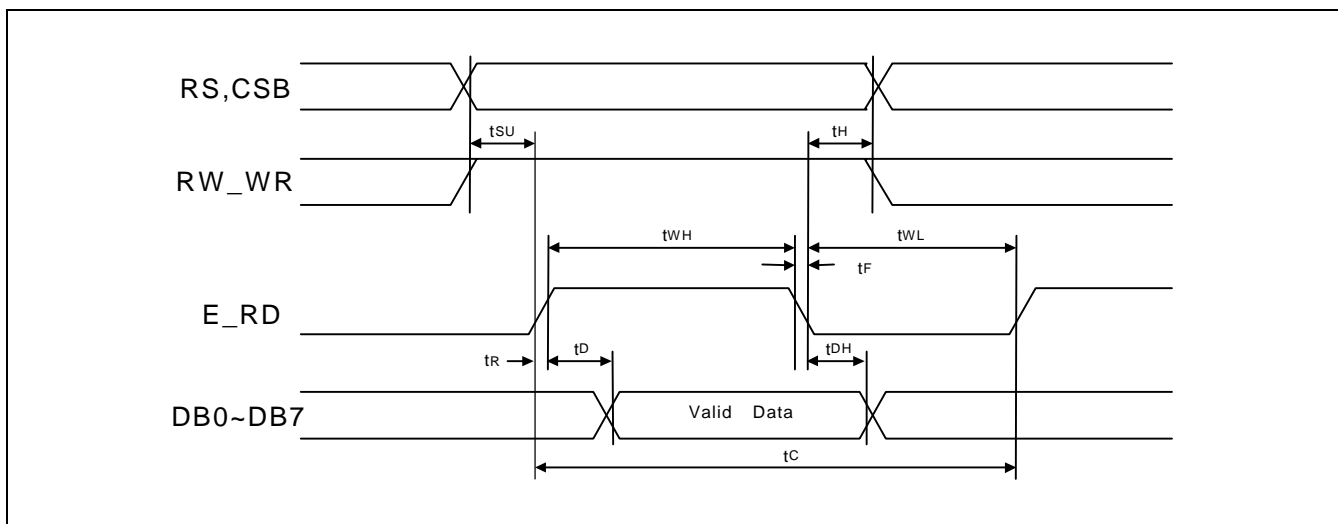

Read Timing Diagram (68-series)

6.4 Instruction Code

INSTRUCTION DESCRIPTION

Instruction Table

Instruction	RE	RS	DB7	DB6	DB5	DB4	DB3	DB2	DB1	DB0	Description
Return home line shift	0	0	0	0	0	1	*	*	*	*	DDRAM address is set to 30h from AC and the cursor returns to home position The contents of DDRAM are not changed.
	1	0	0	0	0	1	*	*	LS1	LS0	Determination of the DDRAM line which is displayed at the first line at LCD LS1, LS0 = 00: DDRAM line 1 shows at the first line of LCD (default) 01: DDRAM line 2 shows at the first line of LCD 10: DDRAM line 3 shows at the first line of LCD 11: DDRAM line 4 shows at the first line of LCD
Line blink double height	0	0	0	0	1	0	LB4	LB3	LB2	LB1	Line blink mode LB4 = 0: DDRAM4 is normal display (default) 1: DDRAM4 is blink mode LB3 = 0: DDRAM3 is normal display (default) 1: DDRAM3 is blink mode LB2 = 0: DDRAM2 is normal display (default) 1: DDRAM2 is blink mode LB1 = 0: DDRAM1 is normal display (default) 1: DDRAM1 is blink mode
	1	0	0	0	1	0	DH4	DH3	DH2	DH1	Doubled height mode DH4 = 0: DDRAM4 is normal display (default) 1: DDRAM4 is double height DH3 = 0: DDRAM3 is normal display (default) 1: DDRAM3 is double height DH2 = 0: DDRAM2 is normal display (default) 1: DDRAM2 is double height DH1 = 0: DDRAM1 is normal display (default) 1: DDRAM1 is double height
Display control	0/1	0	0	0	1	1	C	B	RE	D	Cursor / blink / display ON / OFF C = 0: cursor OFF (default) 1: cursor ON B = 0: blink OFF (default) 1: blink ON RE=0: extension register OFF (default) 1: extension register ON D = 0: display OFF (default) 1: display ON
Power save	0/1	0	0	1	0	0	*	*	OS	PS	Power save / oscillation circuit ON / OFF OS = 0: oscillator OFF (default) 1: oscillator ON PS = 0: power save OFF (default) 1: power save ON

Instruction Table (Continued)

Instruction	RE	RS	DB7	DB6	DB5	DB4	DB3	DB2	DB1	DB0	Description
Power control	0	0	0	1	0	1	HPM	VR	VF	VC	LCD power control HPM = 0: high power mode OFF (default) 1: High power mode ON VR = 0 : Voltage regulator OFF (default) 1 : Voltage regulator ON VF = 0 : Voltage follower OFF (default) 1 : Voltage follower ON VC = 0 : Voltage converter OFF (default) 1 : Voltage converter ON
	1	0	0	1	0	1	IRS	BS	IR1	IR0	Internal resistor select IRS = 0: external resistors are used for regulator (default) 1: internal resistors are used for regulator LCD bias select BS = 0: 1/5 bias (default) 1: 1/4 bias Internal resistor ratio select IR1, IR0 = 00: (1+Rb/Ra) = 2.81 01: (1+Rb/Ra) = 3.27 10: (1+Rb/Ra) = 3.50 11: (1+Rb/Ra) = 3.00
System set	0	0	0	1	1	0	R1	R0	CS	CG	Option CGROM select R1,R0 = 00: main ROM + option ROM1 (default) 01: main ROM + option ROM2 10: main ROM + option ROM3 11: main ROM + option ROM4 Shifting direction of COM CS = 0: COM1 → COM32 (default) 1: COM32 → COM1 Select CGRAM or CGROM CG = 0: CGROM (default), 1: CGRAM
	1	0	0	1	1	0	*	*	SS	*	Segment symmetry of each segment character SS = 0: normal character display (default) 1: symmetrical character display
DDRAM / CGRAM address set	0	0	1	AC6	AC5	AC4	AC3	AC2	AC1	AC0	DDRAM or Electronic volume Address Range: 30h - 7Fh
	1	0	1	AC6	AC5	AC4	AC3	AC2	AC1	AC0	CGRAM or segment ICON RAM Address Range: 00h - 2Fh
Write data	0/1	1	D7	D6	D5	D4	D3	D2	D1	D0	Write DDRAM / CGRAM / ICONRAM/electronic volume RAM This is determined by the address set instruction executed immediately before writing data.
Read data	0/1	1	D7	D6	D5	D4	D3	D2	D1	D0	Read DDRAM / CGRAM / ICONRAM This is determined by the address set instruction executed immediately before reading data.
NOP	0/1	0	0	0	0	0	0	0	0	0	Non-operation Instruction
Test	0/1	0	0	0	0	0	*	*	*	*	Don't use this Instruction

NOTES:

1. "-": Don't care
2. "*": Don't use

7. Optical Characteristics

7.1 Optical Characteristics

Ta=25°C

Item	Symbol	Condition	Min.	Typ.	Max.	Unit	
Viewing Angle	θ_x	$C_r \geq 2$	$\theta_y = 0^\circ$	-30	--	20	Deg
	θ_y			$\theta_x = 0^\circ$	-30	--	
Contrast Ratio	C_r	$\theta_x = 0^\circ$ $\theta_y = 0^\circ$	3.0		-	-	
Response Time	Turn on	T_{on}	$\theta_x = 0^\circ$ $\theta_y = 0^\circ$	-	-	300	ms
	Turn off	T_{off}		-	-	300	

7.2 Definition of Optical Characteristics

7.2.1 Definition of Viewing Angle

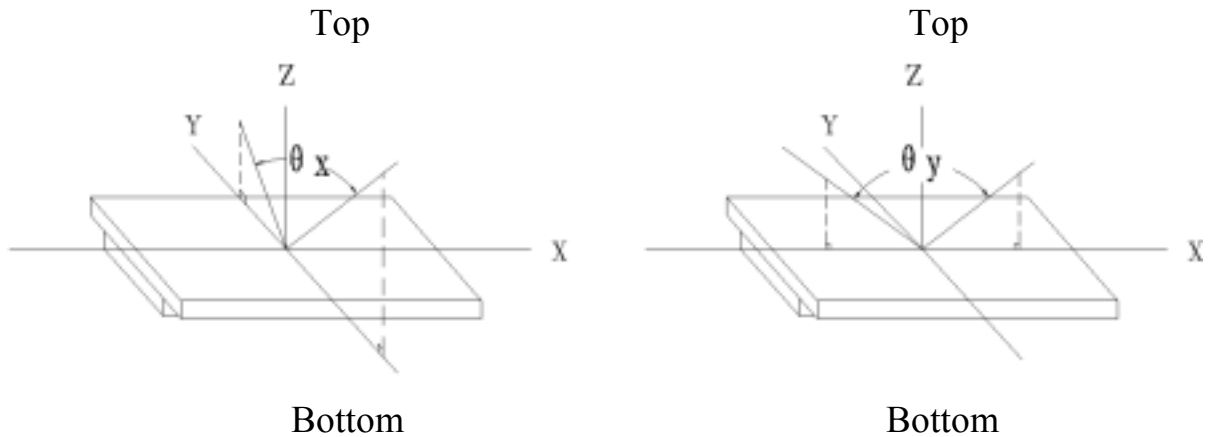

7.2.2 Definition of Contrast Ratio

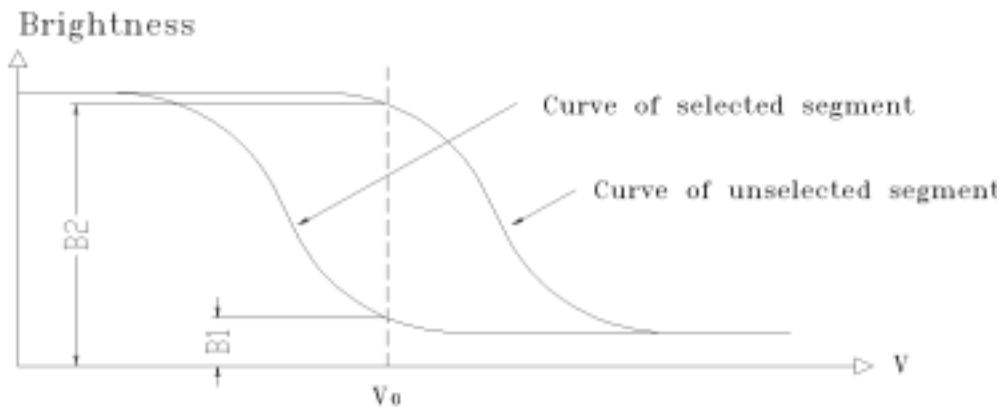

$$\text{Contrast Ratio} = B2/B1 = \frac{\text{unselected state brightness}}{\text{selected state brightness}}$$

Measuring Conditions:

- 1) Ambient Temperature: 25°C ;
- 2) Frame frequency: 70Hz

7.2.3 Definition of Response time

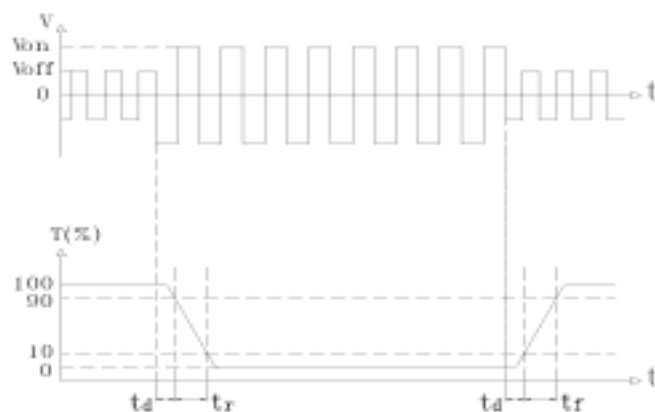

Turn on time: $t_{on} = t_d + t_r$

Turn off time: $t_{off} = t_d + t_f$

Measuring Condition:

- 1) Operating Voltage: 5.0V
- 2) Frame frequency: 70Hz

8. Reliability

8.1 Content of Reliability Test

Ta=25°C

No.	Test Item	Content of Test	Test condition
1	High Temperature Storage	Endurance test applying the high storage temperature for a long time	60°C 96H
2	Low Temperature Storage	Endurance test applying the low storage temperature for a long time	-20°C 96H
3	High Temperature Operation	Endurance test applying the electric stress (voltage & current) and the thermal stress to the element for a long time	50°C 96H
4	Low Temperature Operation	Endurance test applying the electric stress under low temperature for a long time	0°C 96H
5	High Temperature /Humidity Storage	Endurance test applying the high temperature and high humidity storage for a long time	40°C 90%RH 96H
6	Temperature Cycle	Endurance test applying the low and high temperature cycle $-20^{\circ}\text{C} \xleftrightarrow{30\text{min}} 25^{\circ}\text{C} \xleftrightarrow{5\text{min}} 60^{\circ}\text{C} \xleftrightarrow{30\text{min}} 25^{\circ}\text{C} \xleftrightarrow{5\text{min}} \leftarrow$ <p style="text-align: center;">1 cycle</p>	-20°C/60°C 10 cycles
7	Vibration Test (package state)	Endurance test applying the vibration during transportation	10Hz~150Hz, 50m/s ² 40min
8	Shock Test (package state)	Endurance test applying the shock during transportation	Half- sine wave, 100m/s ² 11ms
9	Atmospheric Pressure Test	Endurance test applying the atmospheric pressure during transportation by air	40kPa 16H

8.2 Failure Judgment Criterion

Criterion Item	Test Item No.									Failure Judgement Criterion
	1	2	3	4	5	6	7	8	9	
Basic Specification	√	√	√	√	√	√	√	√	√	Out of the basic Specification
Electrical specification	√	√	√	√	√					Out of the electrical specification
Mechanical Specification							√	√		Out of the mechanical specification
Optical Characteristic	√	√	√	√	√	√			√	Out of the optical specification
Note	For test item refer to 8.1									
Remark	Basic specification = Optical specification + Mechanical specification									

9. QUALITY LEVEL

Examination or Test	At $T_a=25^\circ\text{C}$ (unless otherwise stated)	Inspection				
		Min.	Max.	Unit	IL	AQL
External Visual Inspection	Under normal illumination and eyesight condition, the distance between eyes and LCD is 25cm.	See Appendix A			II	Major 1.0 Minor 2.5
Display Defects	Under normal illumination and eyesight condition, display on inspection.	See Appendix B			II	Major 1.0 Minor 2.5
Note: Major defects: Open segment or common, Short, Serious damages, Leakage Miner defects: Others Sampling standard conforms to GB2828						

10. Precautions for Use of LCD Modules

10.1 Handling Precautions

10.1.1 The display panel is made of glass. Do not subject it to a mechanical shock by dropping it from a high place, etc.

10.1.2 If the display panel is damaged and the liquid crystal substance inside it leaks out, be sure not to get any in your mouth, if the substance comes into contact with your skin or clothes, promptly wash it off using soap and water.

10.1.3 Do not apply excessive force to the display surface or the adjoining areas since this may cause the color tone to vary.

10.1.4 The polarizer covering the display surface of the LCD module is soft and easily scratched. Handle this polarizer carefully.

10.1.5 If the display surface is contaminated, breathe on the surface and gently wipe it with a soft dry cloth. If still not completely clear, moisten cloth with one of the following solvents:

- Isopropyl alcohol
- Ethyl alcohol

Solvents other than those mentioned above may damage the polarizer.

Especially, do not use the following:

- Water
- Ketone
- Aromatic solvents

10.1.6 Do not attempt to disassemble the LCD Module.

10.1.7 If the logic circuit power is off, do not apply the input signals.

10.1.8 To prevent destruction of the elements by static electricity, be careful to maintain an optimum work environment.

- a. Be sure to ground the body when handling the LCD Modules.
- b. Tools required for assembly, such as soldering irons, must be properly ground.
- c. To reduce the amount of static electricity generated, do not conduct assembly and other work under dry conditions.
- d. The LCD Module is coated with a film to protect the display surface. Be care when peeling off this protective film since static electricity may be generated.

10.2 Storage precautions

10.2.1 When storing the LCD modules, avoid exposure to direct sunlight or to the light of fluorescent lamps.

10.2.2 The LCD modules should be stored under the storage temperature range. If the LCD modules will be stored for a long time, the recommend condition is:

Temperature : $0^{\circ}\text{C} \sim 40^{\circ}\text{C}$

Relatively humidity: $\leq 80\%$

10.2.3 The LCD modules should be stored in the room without acid, alkali and harmful gas.

10.3 The LCD modules should be no falling and violent shocking during transportation, and also should avoid excessive press, water, damp and sunshine.

Appendix A

Inspection items and criteria for appearance defects

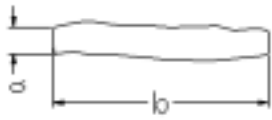
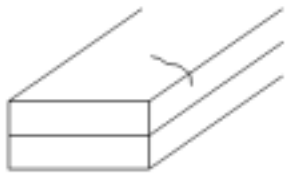
Items	Contents	Criteria			
Leakage		Not permitted			
Rainbow		According to the limit specimen			
Polarizer	Wrong polarizer attachment	Not permitted			
	Bubble between polarizer and glass	Not counted	Max. 3 defects allowed		
		$\phi < 0.3\text{mm}$	$0.3\text{mm} \leq \phi \leq 0.5\text{mm}$		
	Scratches of polarizer	According to the limit specimen			
Black spot (in viewing area)		Not counted	Max. 3 spots allowed	Max. 3 spots (lines) allowed	
		$X < 0.2\text{mm}$	$0.2\text{mm} \leq X \leq 0.5\text{mm}$		
		$X = (a+b)/2$			
Black line (in viewing area)		Not counted	Max. 3 lines allowed		
		$a < 0.02\text{mm}$	$0.02\text{mm} \leq a \leq 0.05\text{mm}$ $b \leq 2.0\text{mm}$		
Progressive cracks		Not permitted			

Appendix A

Inspection item and criteria for appearance defects (continued)

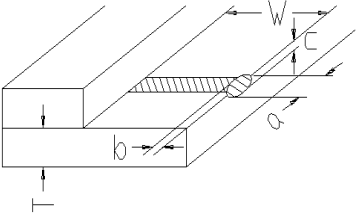
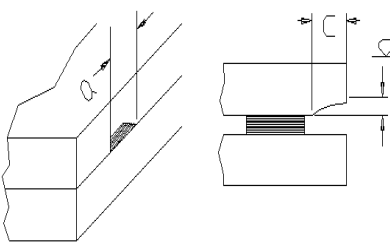
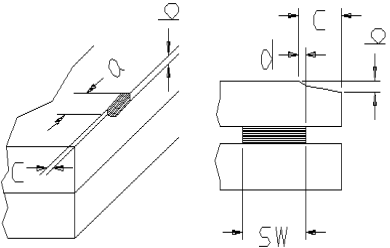
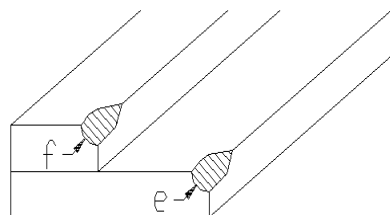
Items	Contents	Criteria				
Glass Cracks	<p>Cracks on pads</p> 	a	b	c	Max. 2 Cracks allowed	Max. 5 cracks allowed
		$\leq 3\text{mm}$	$\leq W/5$	$\leq T/2$		
		$\leq 2\text{mm}$	$\leq W/5$	$T/2 < C < T$		
	<p>Cracks on contact side</p> 	a	b		Max. 2 cracks allowed	
		$\leq 3\text{mm}$	$\leq T/2$			
		$\leq 2\text{mm}$	$T/2 < b < T$			
		C shall be not reach the seal area				
	<p>Cracks on non-contact side</p> 	a	b		Max. 2 cracks allowed	
		$\leq 3\text{mm}$	$\leq T/2$			
		$\leq 2\text{mm}$	$T/2 < b < T$			
	$C \leq 0.5\text{mm}$					
	$d \leq SW/3$					
<p>Corner cracks</p> 	$e < 2.0\text{mm}^2$ $f < 2.0\text{mm}^2$			Max. 3 cracks allowed		

Appendix B

Inspection items and criteria for display defects

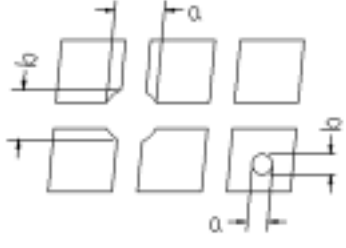
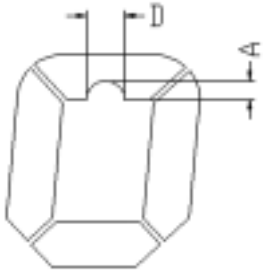
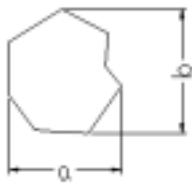
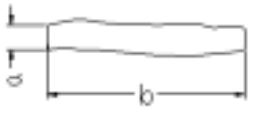
Items	Contents	Criteria		
Open segment or open common		Not permitted		
Short		Not permitted		
Wrong viewing angle		Not permitted		
Contrast ratio uneven		According to the limit specimen		
Crosstalk		According to the limit specimen		
Pin holes and cracks in segment (DOT)		Not counted	Max.3 dots allowed	Max.3 dots allowed
		$X < 0.1\text{mm}$	$0.1\text{mm} \leq X \leq 0.2\text{mm}$	
		$X = (a+b)/2$		
		Not counted	Max.2 dots allowed	
$A < 0.1\text{mm}$		$0.1\text{mm} \leq A \leq 0.2\text{mm}$ $D < 0.25\text{mm}$		
Black spot (in viewing area)		Not counted	Max.3 spots allowed	Max.3 spots (lines) allowed
		$X < 0.1\text{mm}$	$0.1\text{mm} \leq X \leq 0.2\text{mm}$	
		$X = (a+b)/2$		
Black line (in viewing area)		Not counted	Max.3 lines allowed	Max.3 spots (lines) allowed
		$a < 0.02\text{mm}$	$0.02\text{mm} \leq a \leq 0.05\text{mm}$ $b \leq 0.5\text{mm}$	

Appendix B

Inspection items and criteria for display defects (continued)

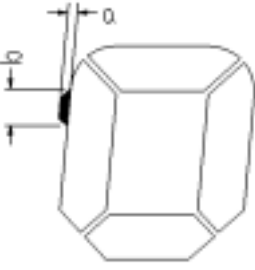
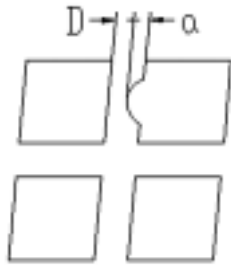
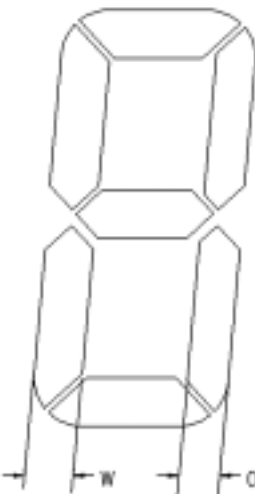
Items	Content	Criteria				
Transformation of segment		Not counted	Max. 2 defects allowed	Max.3 defects allowed		
		$x < 0.1\text{mm}$	$0.1\text{mm} \leq x \leq 0.2\text{mm}$			
		$x = (a+b)/2$				
		Not counted	Max. 1 defects allowed			
		$a < 0.1\text{mm}$	$0.1\text{mm} \leq a \leq 0.2\text{mm}$ $D > 0$			
		Max.2 defects allowed $0.8W \leq a \leq 1.2W$ a =measured value of width W =nominal value of width				