

N-channel MOSFET

Features

- Low gate charge
- 100% avalanche tested
- Improved dv/dt capability
- RoHS compliant
- JEDEC Qualification

BV_{DSS}	I_D	$R_{DS(on)MAX}$
900V	11A	<0.95 Ω

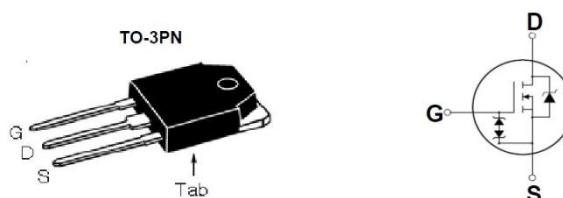

Device	Package	Marking	Remark
TMAN11N90Z	TO-3PN	TMAN11N90Z	RoHS

Absolute Maximum Ratings

Parameter	Symbol	TMAN11N90Z	Unit
Drain-Source Voltage	V_{DS}	900	V
Gate-Source Voltage	V_{GS}	± 30	V
Continuous Drain Current	I_D	$T_C = 25\text{ }^\circ\text{C}$	11
		$T_C = 100\text{ }^\circ\text{C}$	8.5
Pulsed Drain Current (Note 1)	I_{DM}	44	A
Single Pulse Avalanche Energy (Note 2)	E_{AS}	360	mJ
Repetitive Avalanche Current (Note 1)	I_{AR}	11	A
Repetitive Avalanche Energy (Note 1)	E_{AR}	41.6	mJ
Power Dissipation	P_D	$T_C = 25\text{ }^\circ\text{C}$	416
		Derate above 25 $^\circ\text{C}$	3.3
Peak Diode Recovery dv/dt (Note 3)	dv/dt	4.5	V/ns
Operating Junction and Storage Temperature Range	T_J, T_{STG}	-55~150	$^\circ\text{C}$
Maximum lead temperature for soldering purposes, 1/8" from case for 5 seconds	T_L	300	$^\circ\text{C}$

* Limited only by maximum junction temperature

Thermal Characteristics

Parameter	Symbol	TMAN11N90Z	Unit
Maximum Thermal resistance, Junction-to-Case	$R_{\theta JC}$	0.3	$^\circ\text{C}/\text{W}$
Maximum Thermal resistance, Junction-to-Ambient	$R_{\theta JA}$	62.5	$^\circ\text{C}/\text{W}$

Electrical Characteristics : $T_C=25^\circ\text{C}$, unless otherwise noted

Parameter	Symbol	Test condition	Min	Typ	Max	Units
OFF						
Drain-Source Breakdown Voltage	BV_{DSS}	$V_{GS} = 0\text{ V}, I_D = 250\ \mu\text{A}$	900	--	--	V
Zero Gate Voltage Drain Current	I_{DSS}	$V_{DS} = 900\text{ V}, V_{GS} = 0\text{ V}$	--	--	1	μA
		$V_{DS} = 720\text{ V}, T_C = 125^\circ\text{C}$	--	--	10	μA
Forward Gate-Source Leakage Current	I_{GSSF}	$V_{GS} = 30\text{ V}, V_{DS} = 0\text{ V}$	--	--	100	μA
Reverse Gate-Source Leakage Current	I_{GSSR}	$V_{GS} = -30\text{ V}, V_{DS} = 0\text{ V}$	--	--	-100	μA

ON

Gate Threshold Voltage	$V_{GS(th)}$	$V_{DS} = V_{GS}, I_D = 250\ \mu\text{A}$	2	--	4	V
Drain-Source On-Resistance	$R_{DS(on)}$	$V_{GS} = 10\text{ V}, I_D = 5.5\text{ A}$	--	0.75	0.95	Ω
Forward Transconductance ^(Note 4)	g_{FS}	$V_{DS} = 30\text{ V}, I_D = 5.5\text{ A}$	--	8	--	S

DYNAMIC

Input Capacitance	C_{iss}	$V_{DS} = 25\text{ V}, V_{GS} = 0\text{ V},$ $f = 1.0\text{ MHz}$	--	3737	--	pF
Output Capacitance	C_{oss}		--	267	--	pF
Reverse Transfer Capacitance	C_{rss}		--	32	--	pF

SWITCHING

Turn-On Delay Time ^(Note 4,5)	$t_{d(on)}$	$V_{DD} = 450\text{ V}, I_D = 11\text{ A},$ $R_G = 25\ \Omega$	--	59	--	ns
Turn-On Rise Time ^(Note 4,5)	t_r		--	62	--	ns
Turn-Off Delay Time ^(Note 4,5)	$t_{d(off)}$		--	408	--	ns
Turn-Off Fall Time ^(Note 4,5)	t_f		--	83	--	ns
Total Gate Charge ^(Note 4,5)	Q_g	$V_{DS} = 720\text{ V}, I_D = 11\text{ A},$ $V_{GS} = 10\text{ V}$	--	95	--	nC
Gate-Source Charge ^(Note 4,5)	Q_{gs}		--	13	--	nC
Gate-Drain Charge ^(Note 4,5)	Q_{gd}		--	40	--	nC

SOURCE DRAIN DIODE

Maximum Continuous Drain-Source Diode Forward Current	I_S	---	--	--	11	A
Maximum Pulsed Drain-Source Diode Forward Current	I_{SM}	---	--	--	44	A
Drain-Source Diode Forward Voltage	V_{SD}	$V_{GS} = 0\text{ V}, I_S = 11\text{ A}$	--	--	1.5	V
Reverse Recovery Time ^(Note 4)	t_{rr}	$V_{GS} = 0\text{ V}, I_S = 11\text{ A}$ $di_F / dt = 100\text{ A}/\mu\text{s}$	--	513	--	ns
Reverse Recovery Charge ^(Note 4)	Q_{rr}		--	6	--	μC

Note :

1. Repeated rating : Pulse width limited by safe operating area
2. $L=5.6\text{mH}, I_{AS} = 11\text{A}, V_{DD} = 50\text{V}, R_G = 25\Omega,$ Starting $T_J = 25^\circ\text{C}$
3. $I_{SD} \leq 11\text{A}, di/dt \leq 200\text{A}/\mu\text{s}, V_{DD} \leq BV_{DS},$ Starting $T_J = 25^\circ\text{C}$
4. Pulse Test : Pulse width $\leq 300\mu\text{s},$ Duty Cycle $\leq 2\%$
5. Essentially Independent of Operating Temperature Typical Characteristics

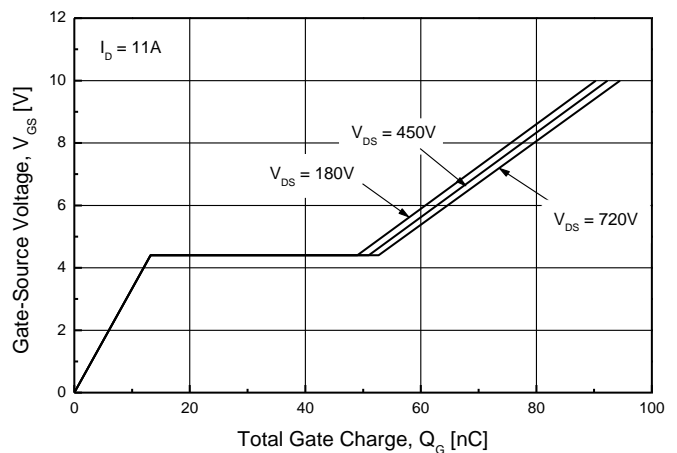
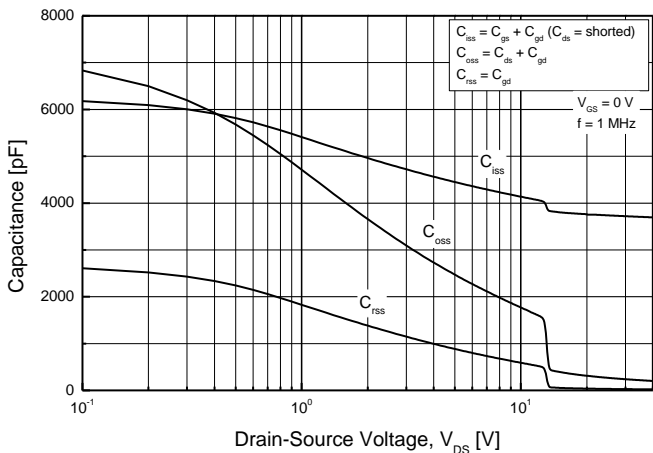
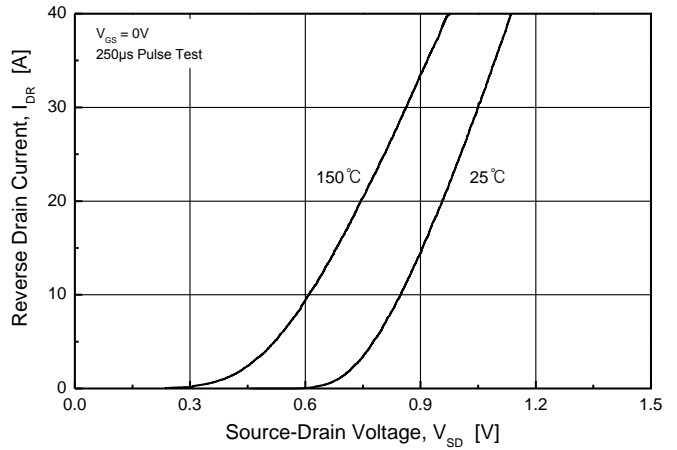
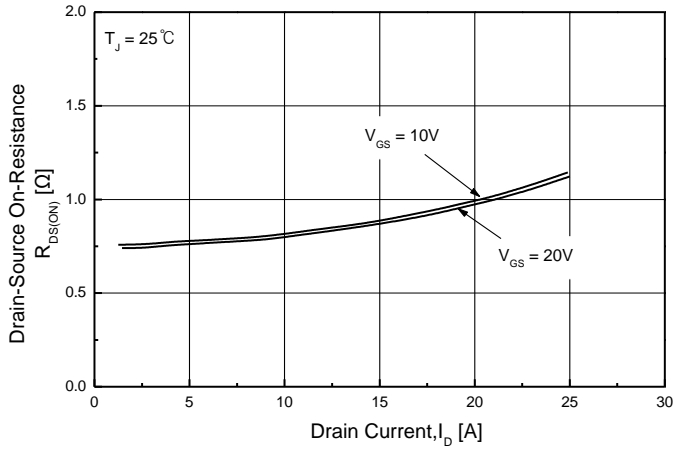
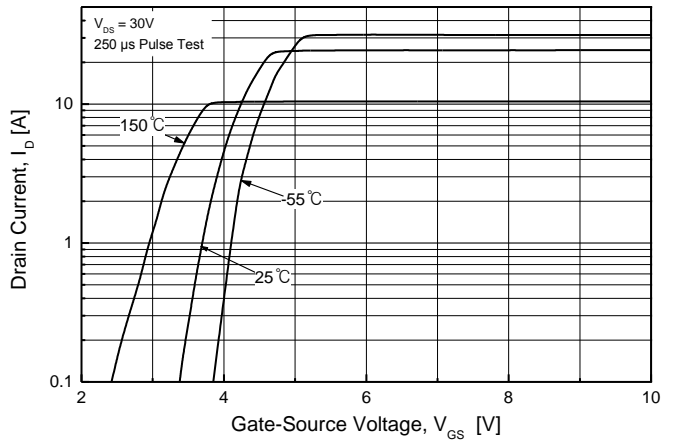
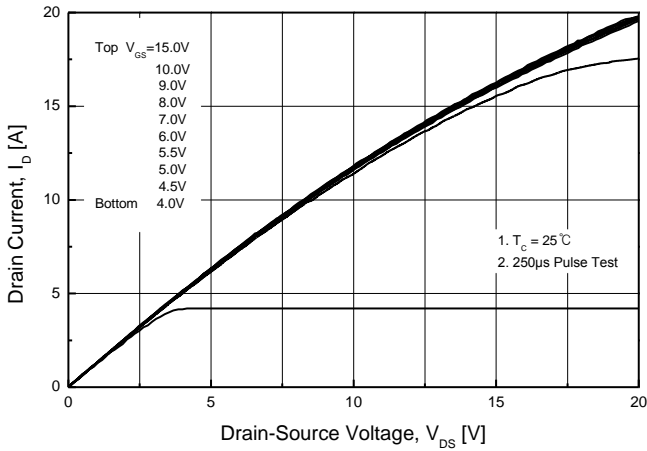

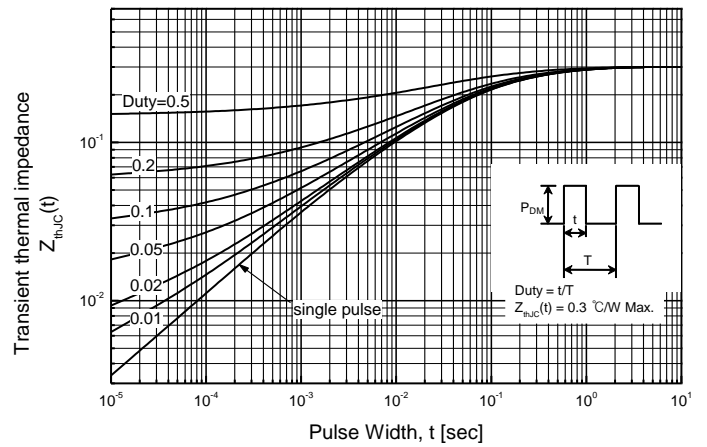
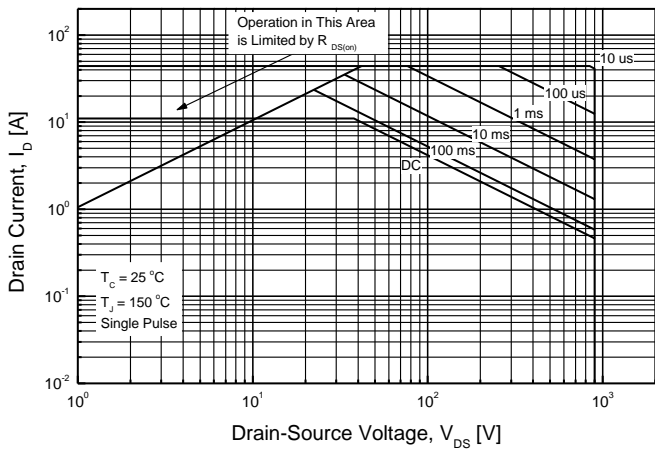
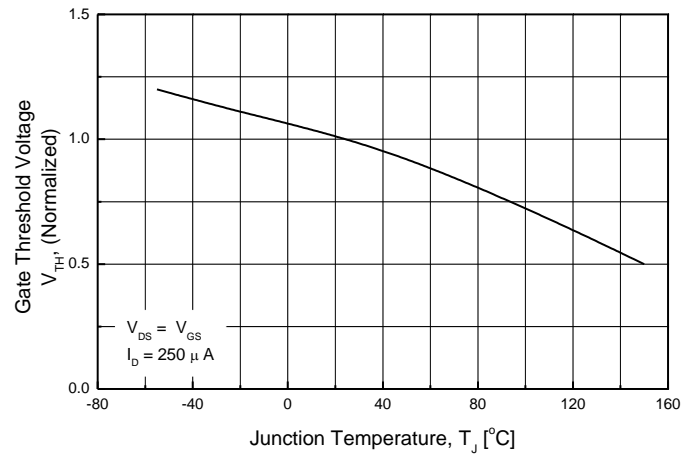
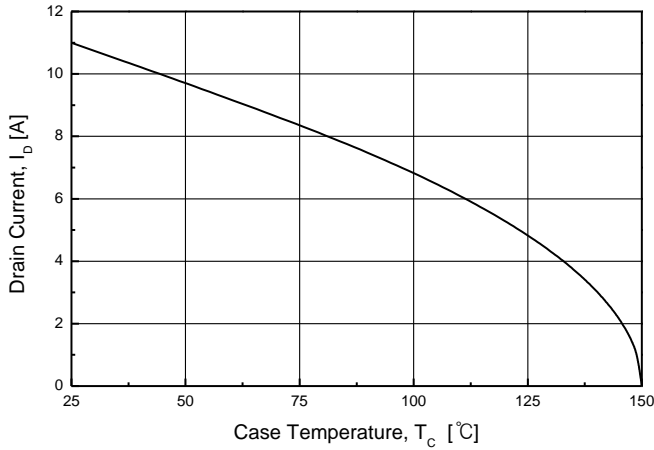
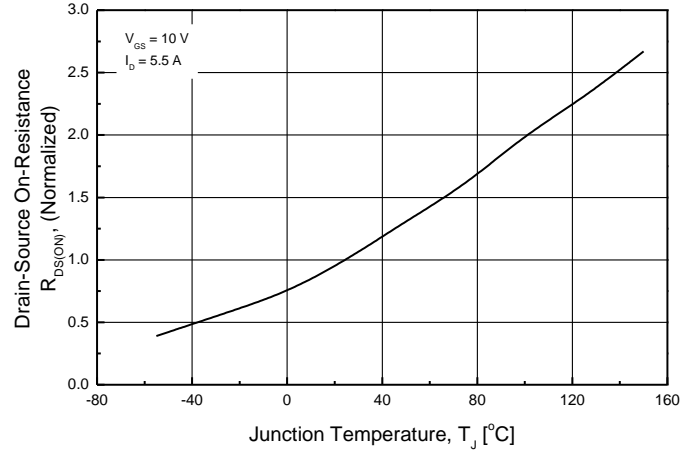
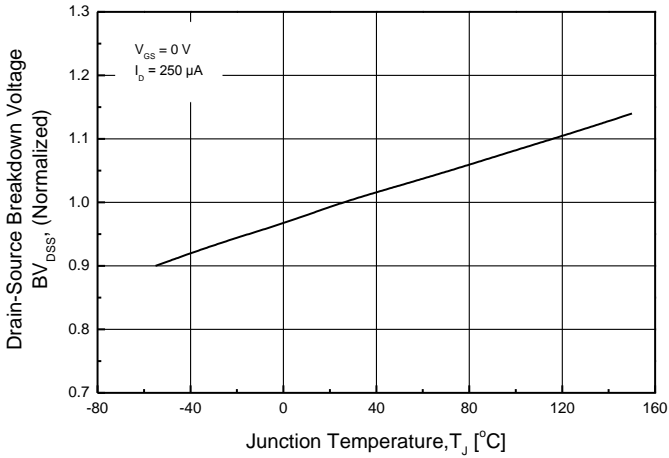

TO-3PN MECHANICAL DATA

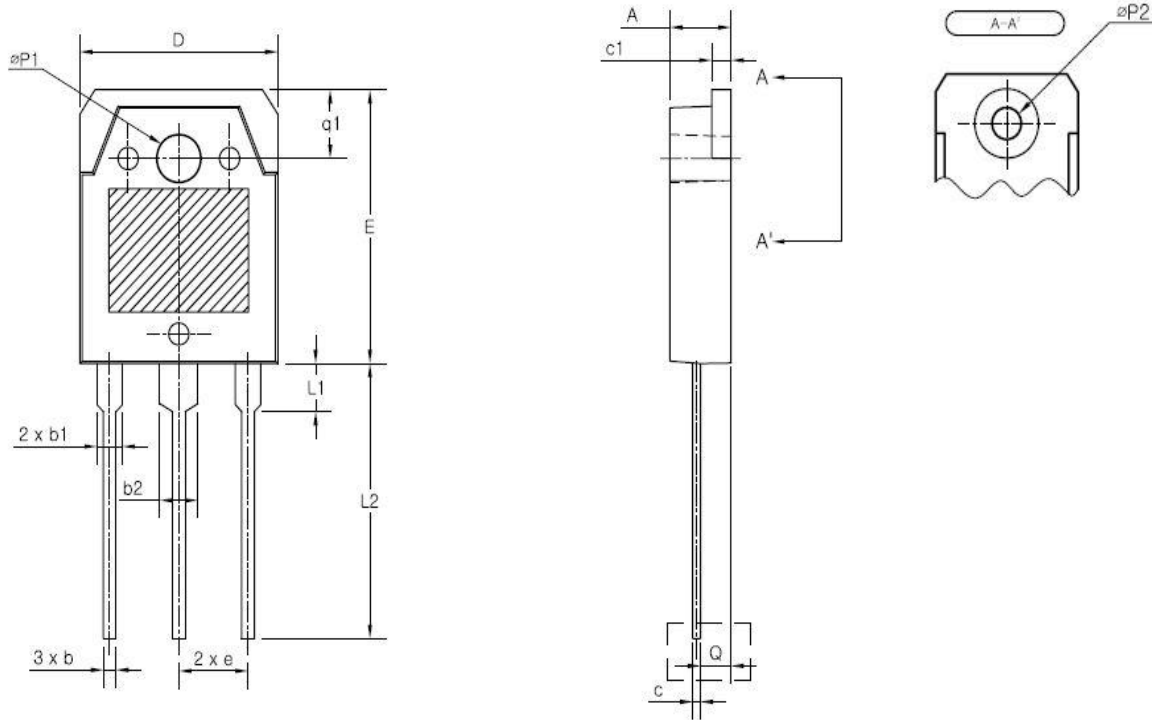

SYMBOL	MIN	NOM	MAX
A	4.60	4.80	5.00
b	0.80	1.00	1.20
b1	1.80	2.00	2.20
b2	2.80	3.00	3.20
c	0.55	0.60	0.75
c1	1.45	1.50	1.65
D	15.40	15.60	15.80
E	19.70	19.90	20.10
e	5.15	5.45	5.75
L1	3.30	3.50	3.70
L2	19.80	20.00	20.20
øP1	3.30	3.40	3.50
øP2	(3.20)		
Q	2.20	2.40	2.60
q1	4.80	5.00	5.20