

Features

- Low gate charge
- 100% avalanche tested
- Improved dv/dt capability
- RoHS compliant
- JEDEC Qualification

BV_{DSS}	I_D	$R_{DS(on)MAX}$
500V	23A	<0.22 Ω

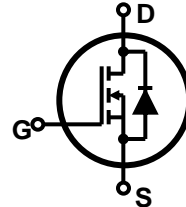
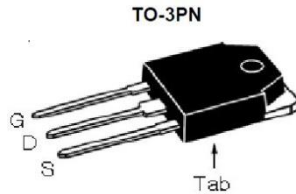

Device	Package	Marking	Remark
TMAN23N50	TO-3PN	TMAN23N50	RoHS

Absolute Maximum Ratings

Parameter	Symbol	TMAN23N50	Unit
Drain-Source Voltage	V_{DS}	500	V
Gate-Source Voltage	V_{GS}	± 30	V
Continuous Drain Current	I_D	$T_C = 25\text{ }^\circ\text{C}$	23
		$T_C = 100\text{ }^\circ\text{C}$	14.5
Pulsed Drain Current (Note 1)	I_{DM}	92	A
Single Pulse Avalanche Energy (Note 2)	E_{AS}	970	mJ
Repetitive Avalanche Current (Note 1)	I_{AR}	23	A
Repetitive Avalanche Energy (Note 1)	E_{AR}	34.7	mJ
Power Dissipation	P_D	$T_C = 25\text{ }^\circ\text{C}$	347
		Derate above 25 $^\circ\text{C}$	2.77
Peak Diode Recovery dv/dt (Note 3)	dv/dt	4.5	V/ns
Operating Junction and Storage Temperature Range	T_J, T_{STG}	-55~150	$^\circ\text{C}$
Maximum lead temperature for soldering purposes, 1/8" from case for 5 seconds	T_L	300	$^\circ\text{C}$

* Limited only by maximum junction temperature

Thermal Characteristics

Parameter	Symbol	TMAN23N50	Unit
Maximum Thermal resistance, Junction-to-Case	$R_{\theta JC}$	0.36	$^\circ\text{C}/\text{W}$
Maximum Thermal resistance, Junction-to-Ambient	$R_{\theta JA}$	62.5	$^\circ\text{C}/\text{W}$

Electrical Characteristics : $T_C=25^\circ\text{C}$, unless otherwise noted

Parameter	Symbol	Test condition	Min	Typ	Max	Units
OFF						
Drain-Source Breakdown Voltage	BV_{DSS}	$V_{GS} = 0\text{ V}, I_D = 250\ \mu\text{A}$	500	--	--	V
Zero Gate Voltage Drain Current	I_{DSS}	$V_{DS} = 500\text{ V}, V_{GS} = 0\text{ V}$	--	--	1	μA
		$V_{DS} = 400\text{ V}, T_C = 125^\circ\text{C}$	--	--	10	μA
Forward Gate-Source Leakage Current	I_{GSSF}	$V_{GS} = 30\text{ V}, V_{DS} = 0\text{ V}$	--	--	100	nA
Reverse Gate-Source Leakage Current	I_{GSSR}	$V_{GS} = -30\text{ V}, V_{DS} = 0\text{ V}$	--	--	-100	nA

ON

Gate Threshold Voltage	$V_{GS(th)}$	$V_{DS} = V_{GS}, I_D = 250\ \mu\text{A}$	2	--	4	V
Drain-Source On-Resistance	$R_{DS(on)}$	$V_{GS} = 10\text{ V}, I_D = 11.5\text{ A}$	--	0.185	0.22	Ω
Forward Transconductance ^(Note 4)	g_{FS}	$V_{DS} = 30\text{ V}, I_D = 11.5\text{ A}$	--	28	--	S

DYNAMIC

Input Capacitance	C_{iss}	$V_{DS} = 25\text{ V}, V_{GS} = 0\text{ V},$ $f = 1.0\text{ MHz}$	--	3391	--	pF
Output Capacitance	C_{oss}		--	357	--	pF
Reverse Transfer Capacitance	C_{rss}		--	14	--	pF

SWITCHING

Turn-On Delay Time ^(Note 4,5)	$t_{d(on)}$	$V_{DD} = 250\text{ V}, I_D = 23\text{ A},$ $R_G = 25\ \Omega$	--	78	--	ns
Turn-On Rise Time ^(Note 4,5)	t_r		--	64	--	ns
Turn-Off Delay Time ^(Note 4,5)	$t_{d(off)}$		--	335	--	ns
Turn-Off Fall Time ^(Note 4,5)	t_f		--	58	--	ns
Total Gate Charge ^(Note 4,5)	Q_g	$V_{DS} = 400\text{ V}, I_D = 23\text{ A},$ $V_{GS} = 10\text{ V}$	--	66	--	nC
Gate-Source Charge ^(Note 4,5)	Q_{gs}		--	20	--	nC
Gate-Drain Charge ^(Note 4,5)	Q_{gd}		--	17	--	nC

SOURCE DRAIN DIODE

Maximum Continuous Drain-Source Diode Forward Current	I_S	---	--	--	23	A
Maximum Pulsed Drain-Source Diode Forward Current	I_{SM}	---	--	--	92	A
Drain-Source Diode Forward Voltage	V_{SD}	$V_{GS} = 0\text{ V}, I_S = 23\text{ A}$	--	--	1.5	V
Reverse Recovery Time ^(Note 4)	t_{rr}	$V_{GS} = 0\text{ V}, I_S = 23\text{ A}$ $di_F / dt = 100\text{ A}/\mu\text{s}$	--	417	--	ns
Reverse Recovery Charge ^(Note 4)	Q_{rr}		--	5.5	--	μC

Note :

1. Repeated rating : Pulse width limited by safe operating area
2. $L=3.3\text{mH}, I_{AS} = 23\text{A}, V_{DD} = 50\text{V}, R_G = 25\Omega,$ Starting $T_J = 25^\circ\text{C}$, , not subject to production test – verified by design/characterization
3. $I_{SD} \leq 23\text{A}, di/dt \leq 200\text{A}/\mu\text{s}, V_{DD} \leq BV_{DS},$ Starting $T_J = 25^\circ\text{C}$
4. Pulse Test :Pulse width $\leq 300\mu\text{s}$, Duty Cycle $\leq 2\%$
5. Essentially Independent of Operating Temperature Typical Characteristics

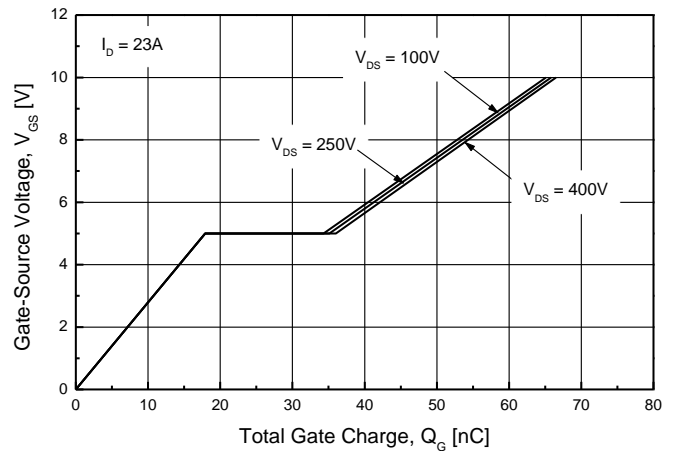
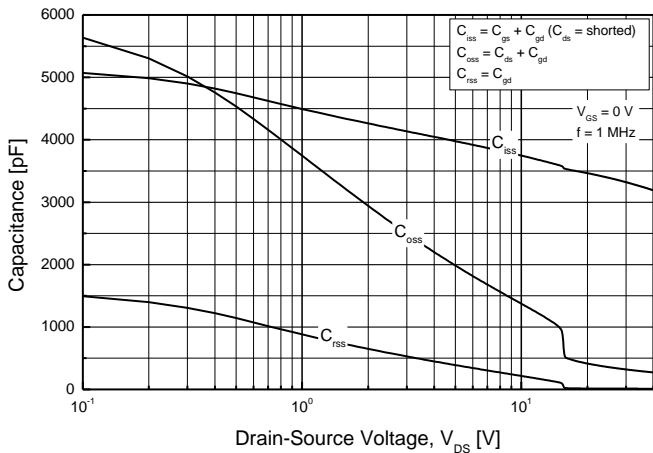
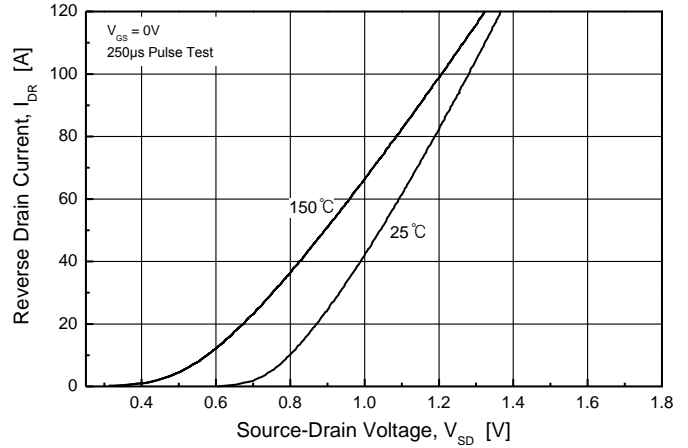
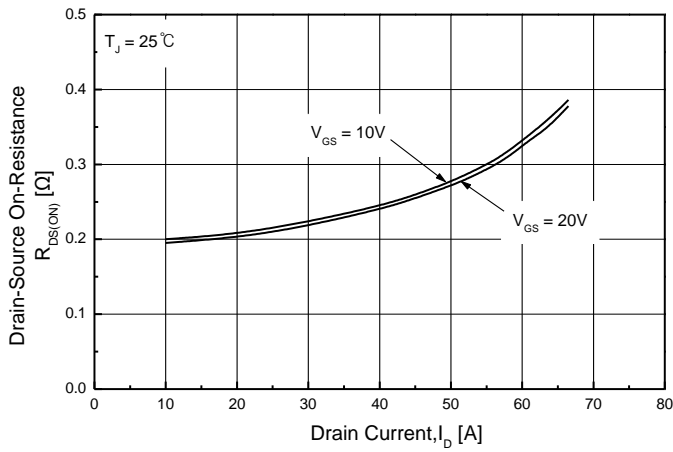
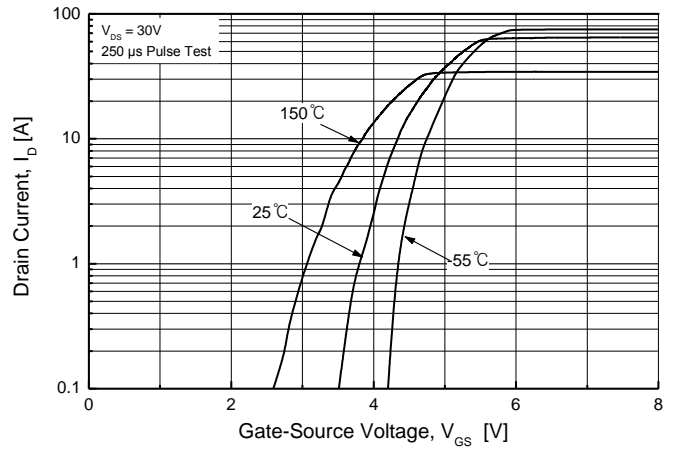
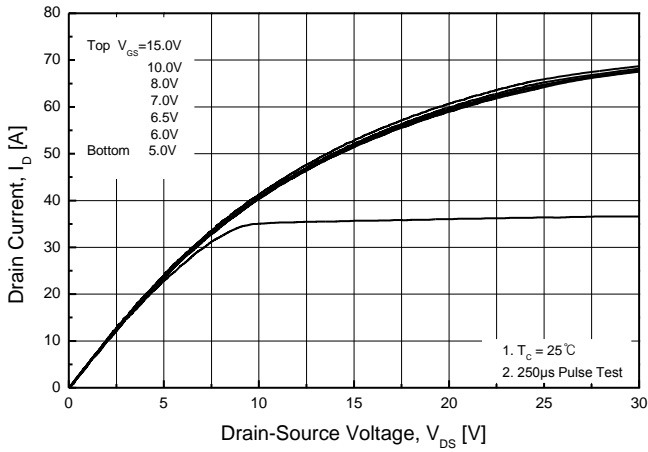

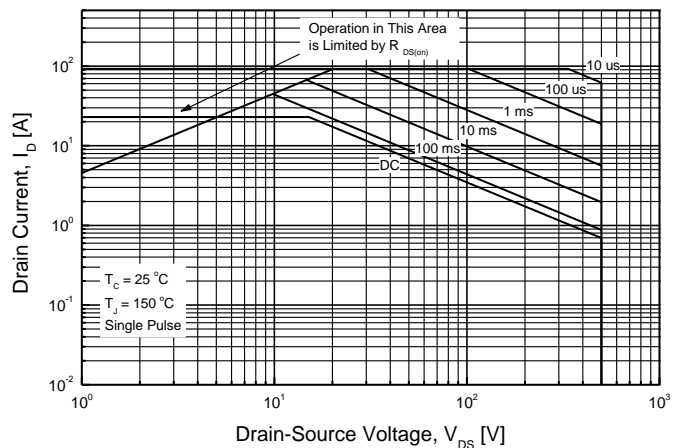
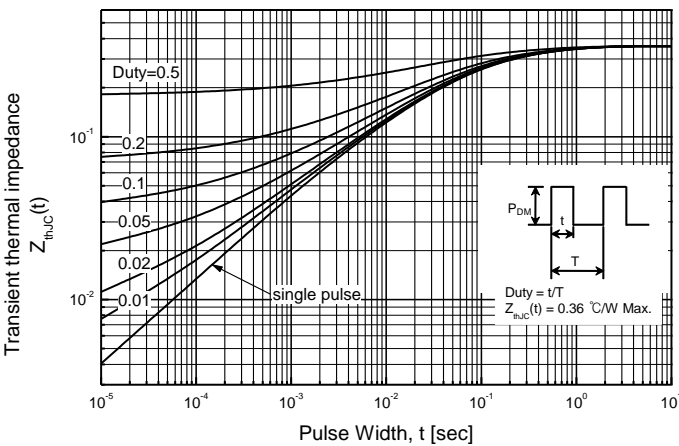
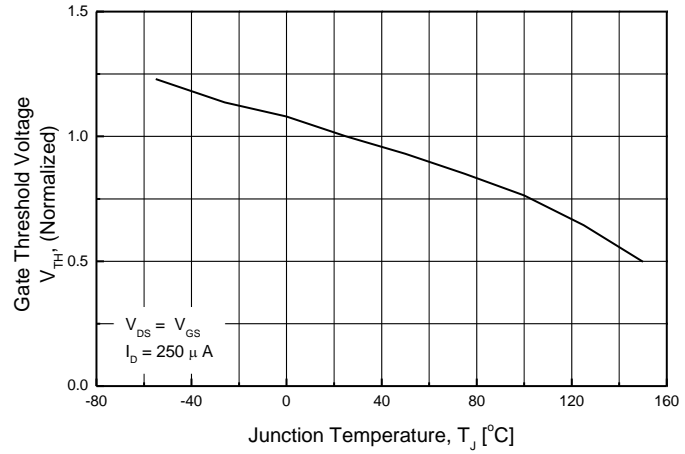
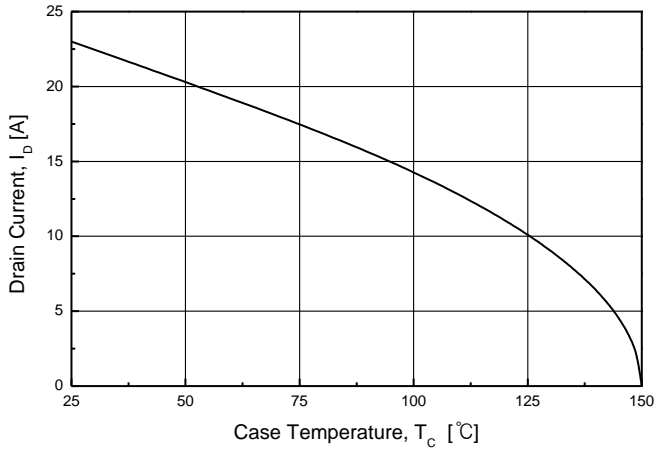
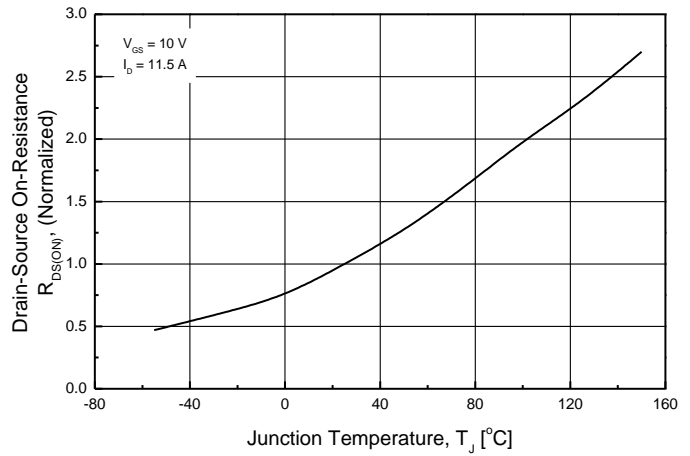
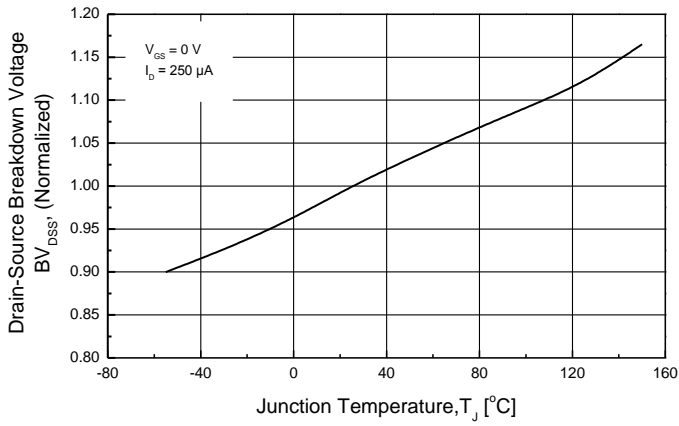

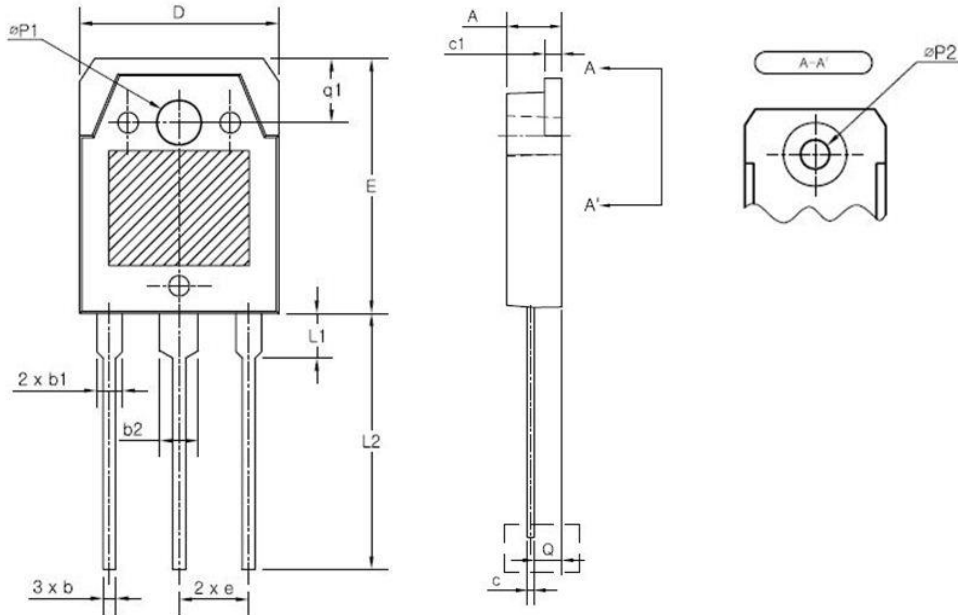
TO-3PN MECHANICAL DATA

SYMBOL	MIN	NOM	MAX
A	4.60	4.80	5.00
b	0.80	1.00	1.20
b1	1.80	2.00	2.20
b2	2.80	3.00	3.20
c	0.55	0.60	0.75
c1	1.45	1.50	1.65
D	15.40	15.60	15.80
E	19.70	19.90	20.10
e	5.15	5.45	5.75
L1	3.30	3.50	3.70
L2	19.80	20.00	20.20
øP1	3.30	3.40	3.50
øP2	(3.20)		
Q	2.20	2.40	2.60
q1	4.80	5.00	5.20

Disclaimer :

TRinno technology reserves the right to make changes without notice to products herein to improve reliability, performance, or design. The information given in this document is believed to be accurate and reliable. However, it shall in no event be regarded as a guarantee of conditions and characteristics. With respect to any information regarding the application of the device, TRinno technology hereby disclaims any and all warranties and liabilities of any kind, including without limitation, warranties of non-infringement of patent rights of any third party.