

Features

- Low gate charge
- 100% avalanche tested
- Improved dv/dt capability
- Halogen free package
- JEDEC Qualification
- Improved ESD performance

$$V_{DSS} = 440 \text{ V @ } T_{jmax}$$

$$I_D = 3.4 \text{ A}$$

$$R_{DS(on)} = 1.6 \text{ } \Omega \text{ (max) @ } V_{GS} = 10 \text{ V}$$

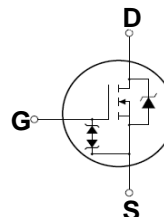
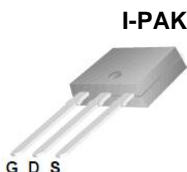

Device	Package	Marking	Remark
TMD5N40ZG/TMU5N40ZG	D-PAK/I-PAK	TMD5N40ZG/TMU5N40ZG	Halogen Free

Absolute Maximum Ratings

Parameter	Symbol	TMD5N40ZG/TMU5N40ZG	Unit
Drain-Source Voltage	V_{DS}	400	V
Gate-Source Voltage	V_{GS}	± 30	V
Continuous Drain Current	I_D	$T_C = 25 \text{ }^\circ\text{C}$	3.4*
		$T_C = 100 \text{ }^\circ\text{C}$	2.15*
Pulsed Drain Current (Note 1)	I_{DM}	13.6*	A
Single Pulse Avalanche Energy (Note 2)	E_{AS}	165	mJ
Repetitive Avalanche Current (Note 1)	I_{AR}	3.4	A
Repetitive Avalanche Energy (Note 1)	E_{AR}	5.0	mJ
Power Dissipation	P_D	$T_C = 25 \text{ }^\circ\text{C}$	50
		Derate above $25 \text{ }^\circ\text{C}$	0.4
Peak Diode Recovery dv/dt (Note 3)	dv/dt	4.5	V/ns
Operating Junction and Storage Temperature Range	T_J, T_{STG}	-55~150	$^\circ\text{C}$
Maximum lead temperature for soldering purposes, 1/8" from case for 5 seconds	T_L	300	$^\circ\text{C}$

* Limited only by maximum junction temperature

Thermal Characteristics

Parameter	Symbol	TMD5N40ZG/TMU5N40ZG	Unit
Maximum Thermal resistance, Junction-to-Case	$R_{\theta JC}$	2.5	$^\circ\text{C/W}$
Maximum Thermal resistance, Junction-to-Ambient	$R_{\theta JA}$	110	$^\circ\text{C/W}$

Electrical Characteristics : $T_C=25^\circ\text{C}$, unless otherwise noted

Parameter	Symbol	Test condition	Min	Typ	Max	Units
OFF						
Drain-Source Breakdown Voltage	BV_{DSS}	$V_{GS} = 0\text{ V}, I_D = 250\ \mu\text{A}$	400	--	--	V
Zero Gate Voltage Drain Current	I_{DSS}	$V_{DS} = 400\text{ V}, V_{GS} = 0\text{ V}$	--	--	1	μA
		$V_{DS} = 320\text{ V}, T_C = 125^\circ\text{C}$	--	--	10	μA
Forward Gate-Source Leakage Current	I_{GSSF}	$V_{GS} = 30\text{ V}, V_{DS} = 0\text{ V}$	--	--	100	μA
Reverse Gate-Source Leakage Current	I_{GSSR}	$V_{GS} = -30\text{ V}, V_{DS} = 0\text{ V}$	--	--	-100	μA
ON						
Gate Threshold Voltage	$V_{GS(th)}$	$V_{DS} = V_{GS}, I_D = 250\ \mu\text{A}$	2	--	4	V
Drain-Source On-Resistance	$R_{DS(on)}$	$V_{GS} = 10\text{ V}, I_D = 1.7\text{ A}$	--	1.2	1.6	Ω
Forward Transconductance ^(Note 4)	g_{FS}	$V_{DS} = 30\text{ V}, I_D = 1.7\text{ A}$	--	7	--	S
DYNAMIC						
Input Capacitance	C_{iss}	$V_{DS} = 25\text{ V}, V_{GS} = 0\text{ V},$ $f = 1.0\text{ MHz}$	--	522	--	pF
Output Capacitance	C_{oss}		--	56	--	pF
Reverse Transfer Capacitance	C_{rss}		--	4.3	--	pF
SWITCHING						
Turn-On Delay Time ^(Note 4,5)	$t_{d(on)}$	$V_{DD} = 200\text{ V}, I_D = 3.4\text{ A},$ $R_G = 25\ \Omega$	--	12	--	ns
Turn-On Rise Time ^(Note 4,5)	t_r		--	10	--	ns
Turn-Off Delay Time ^(Note 4,5)	$t_{d(off)}$		--	38	--	ns
Turn-Off Fall Time ^(Note 4,5)	t_f		--	9	--	ns
Total Gate Charge ^(Note 4,5)	Q_g	$V_{DS} = 320\text{ V}, I_D = 3.4\text{ A},$ $V_{GS} = 10\text{ V}$	--	7.1	--	nC
Gate-Source Charge ^(Note 4,5)	Q_{gs}		--	2.2	--	nC
Gate-Drain Charge ^(Note 4,5)	Q_{gd}		--	1.7	--	nC
SOURCE DRAIN DIODE						
Maximum Continuous Drain-Source Diode Forward Current	I_S	---	--	--	3.4	A
Maximum Pulsed Drain-Source Diode Forward Current	I_{SM}	---	--	--	13.6	A
Drain-Source Diode Forward Voltage	V_{SD}	$V_{GS} = 0\text{ V}, I_S = 3.4\text{ A}$	--	--	1.5	V
Reverse Recovery Time ^(Note 4)	t_{rr}	$V_{GS} = 0\text{ V}, I_S = 3.4\text{ A}$ $di_F / dt = 100\text{ A}/\mu\text{s}$	--	185	--	ns
Reverse Recovery Charge ^(Note 4)	Q_{rr}		--	0.8	--	μC

Note :

1. Repeated rating : Pulse width limited by safe operating area
2. $L=25\text{mH}, I_{AS}=3.4\text{A}, V_{DD}=50\text{V}, R_G=25\Omega$, Starting $T_J=25^\circ\text{C}$
3. $I_{SD} \leq 3.4\text{A}, di/dt \leq 200\text{A}/\mu\text{s}, V_{DD} \leq BV_{DS}$, Starting $T_J=25^\circ\text{C}$
4. Pulse width $\leq 300\mu\text{s}$, Duty Cycle $\leq 2\%$
5. Essentially Independent of Operating Temperature Typical Characteristics

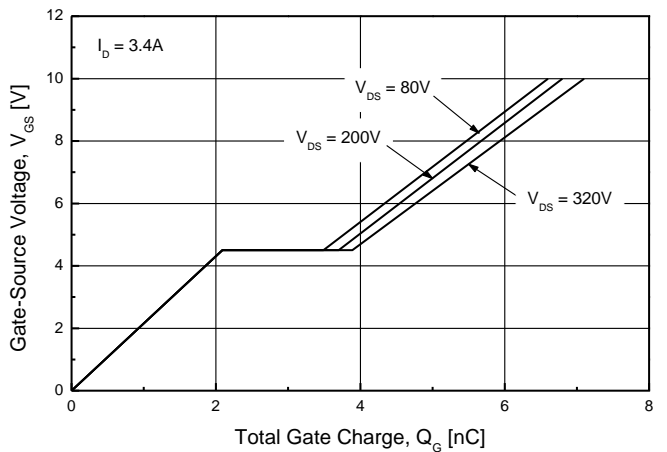
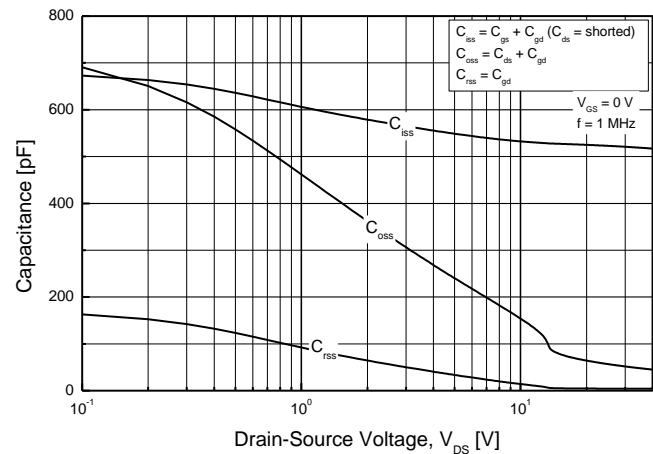
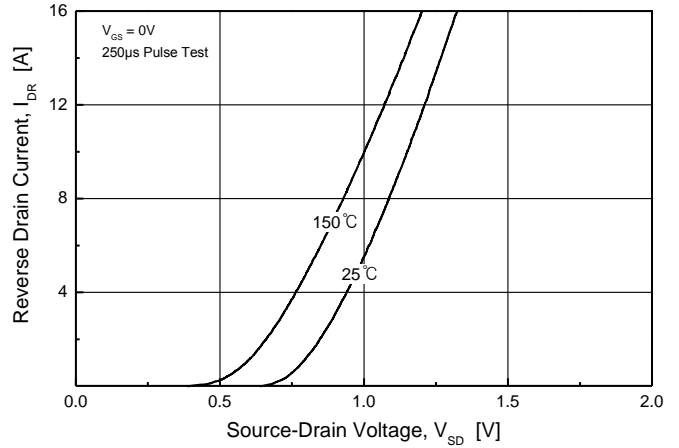
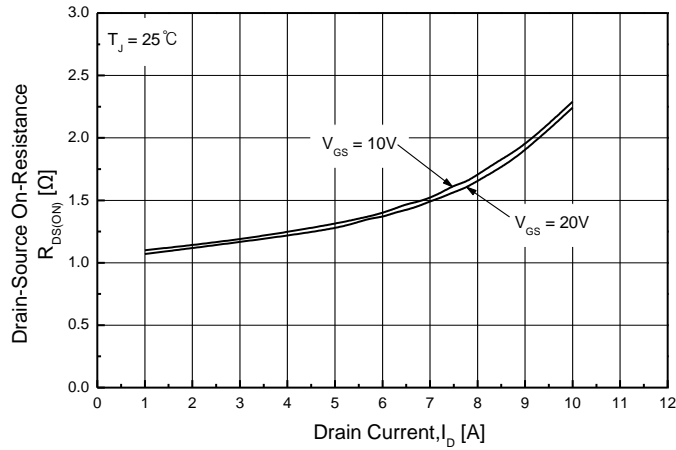
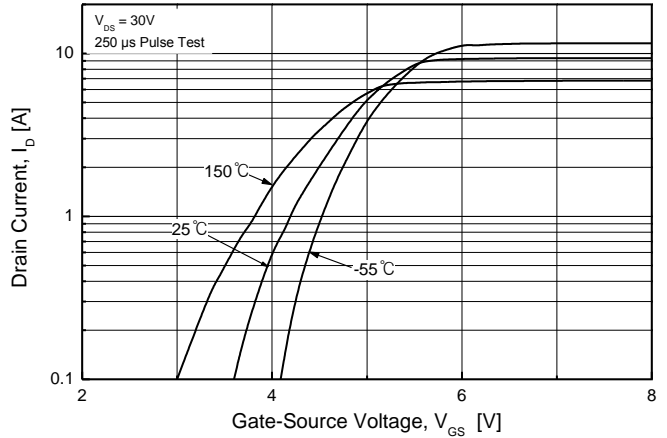
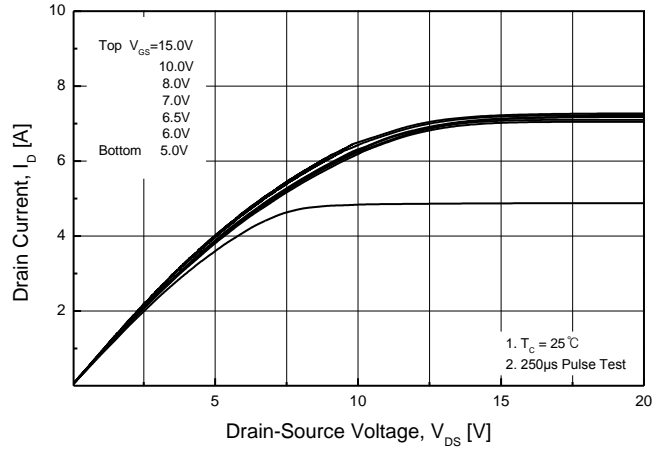

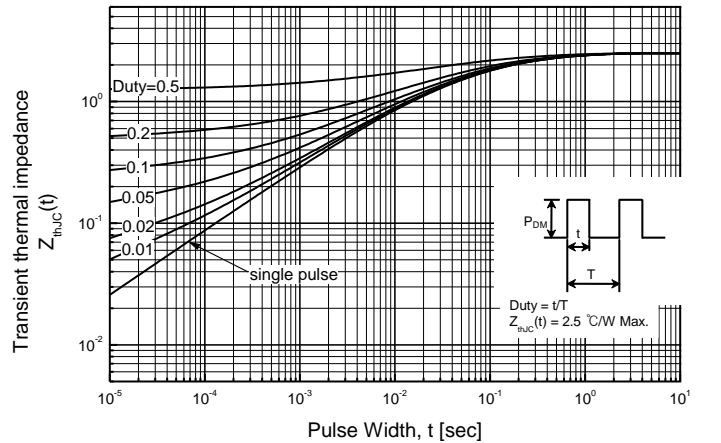
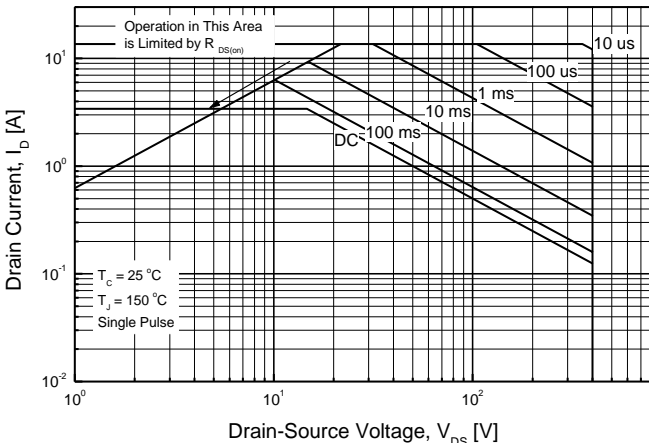
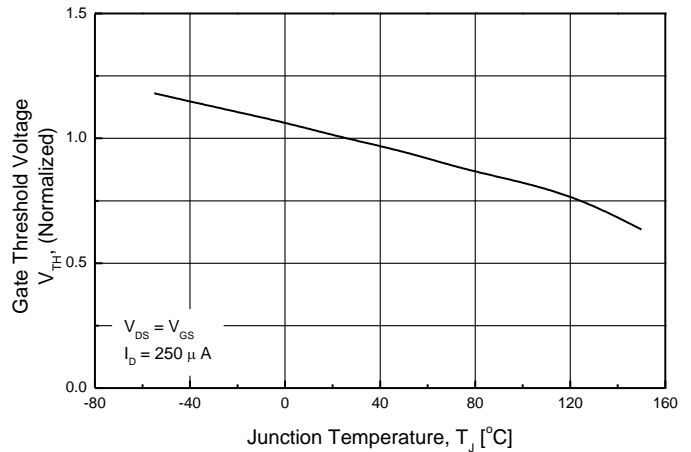
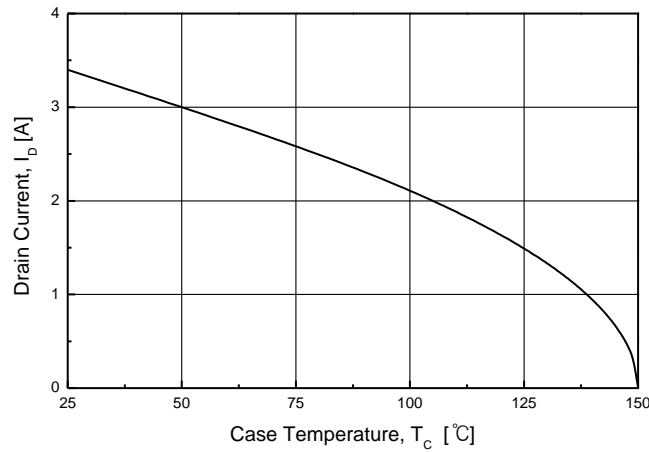
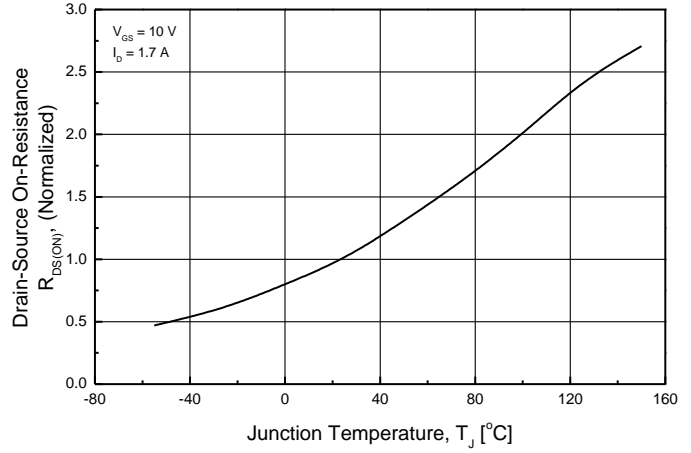
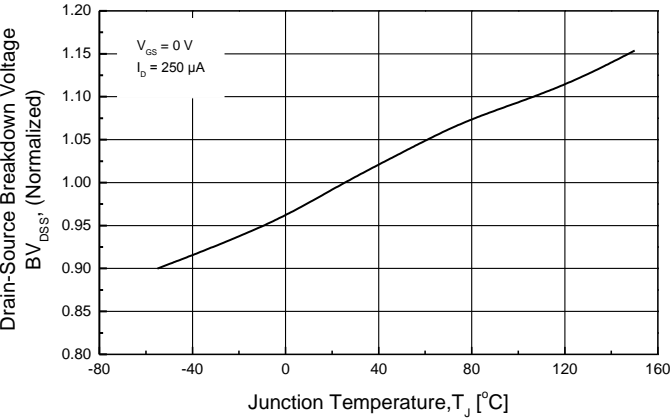

TO-252 (D-PAK) MECHANICAL DATA

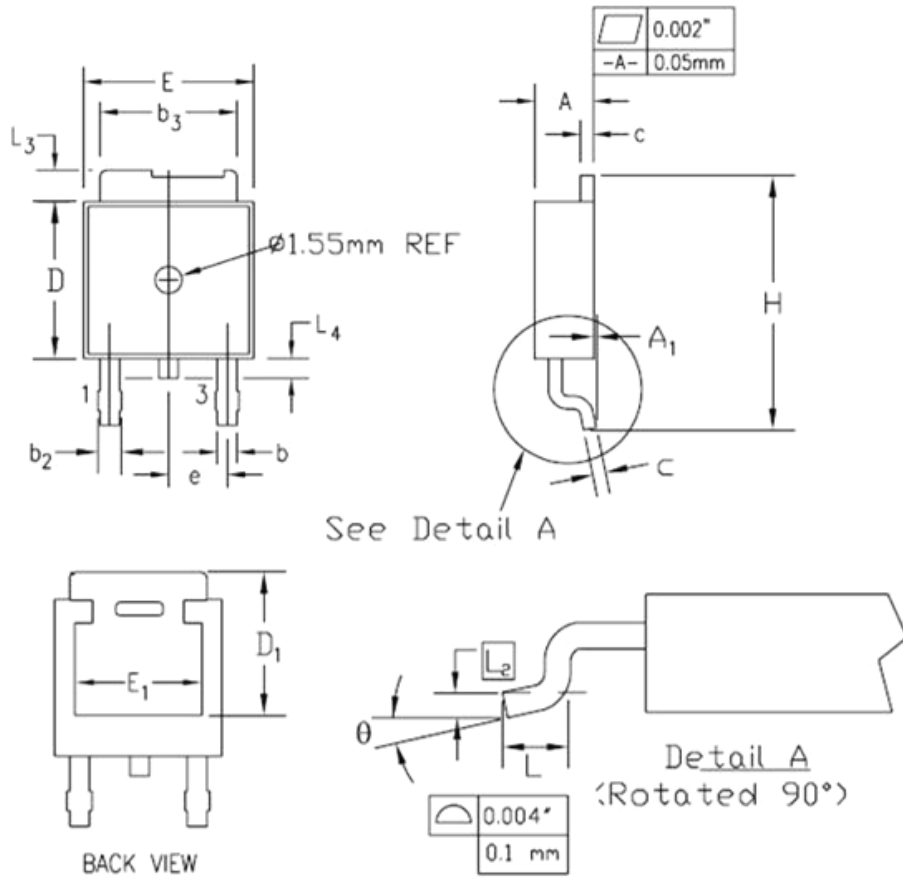

SYMBOL	INCHES		MILLIMETERS		NOTES
	MIN.	MAX.	MIN.	MAX.	
A	0.086	0.094	2.19	2.38	
A ₁	—	0.005	—	0.13	
b	0.025	0.035	0.64	0.89	
b ₂	0.033	0.045	0.84	1.14	
b ₃	0.205	0.215	5.21	5.46	
c	0.018	0.024	0.46	0.61	
D	0.235	0.245	5.97	6.22	
D ₁	0.205	—	5.21	—	2
E	0.250	0.265	6.35	6.73	
E ₁	0.190	—	4.83	—	2
e	0.090 BSC		2.29 BSC		
H	0.380	0.410	9.65	10.41	
L	0.055	0.070	1.40	1.78	4
L ₂	0.020 BSC		0.51 BSC		
L ₃	0.035	0.050	0.89	1.27	
L ₄	0.025	0.040	0.64	1.01	3
θ	0°	8°	0°	8°	

TO-251 (I-PAK) MECHANICAL DATA

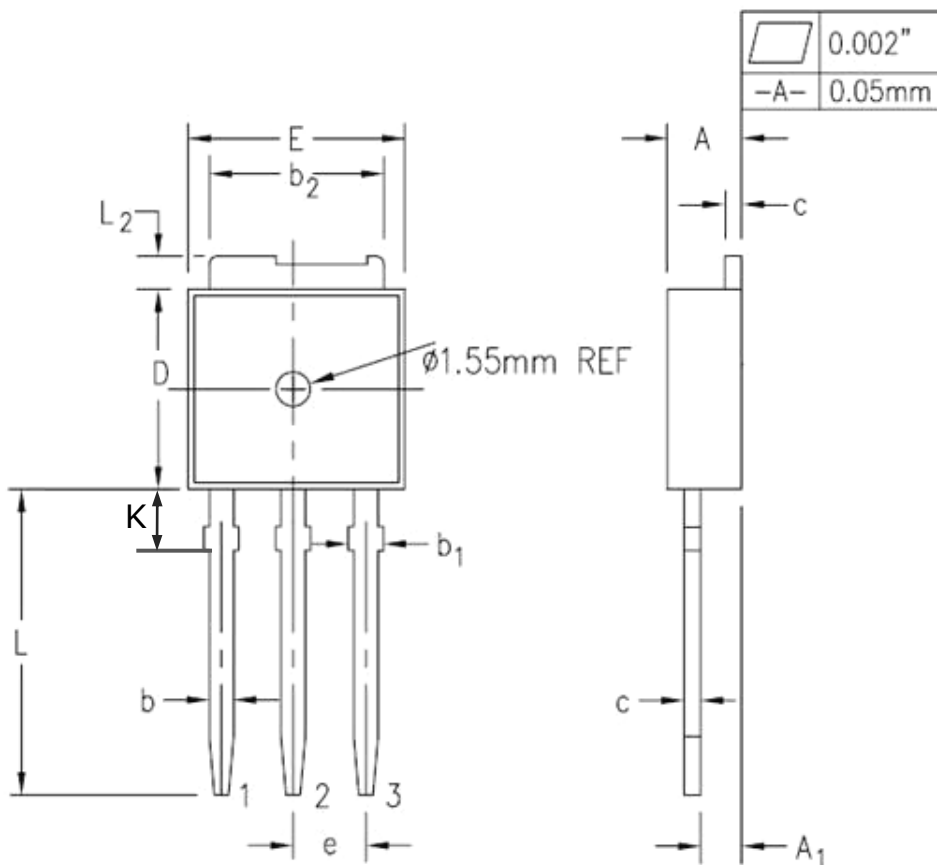

SYMBOL	INCHES		MILIMETERS		NOTES
	MIN.	MAX.	MIN.	MAX.	
A	0.086	0.094	2.19	2.39	
A1	0.040	0.045	1.02	1.14	
b	0.025	0.035	0.64	0.89	
b1	0.037	0.045	0.95	1.14	
b2	0.205	0.215	5.21	5.46	
c	0.018	0.023	0.46	0.58	
D	0.235	0.245	5.97	6.22	
E	0.250	0.265	6.35	6.73	
e	0.090 TYP.		2.28 TYP.		
L	0.350	0.380	8.89	9.65	
L2	0.035	0.050	0.89	1.27	
K	0.079	0.096	2.00	2.44	