

## Features

- Low gate charge
- 100% avalanche tested
- Improved dv/dt capability
- RoHS compliant
- Halogen free package
- JEDEC Qualification
- Improved ESD performance

N-channel MOSFET

|            |       |              |
|------------|-------|--------------|
| $BV_{DSS}$ | $I_D$ | $R_{DS(on)}$ |
| 600V       | 2.0A  | < 4.0Ω       |

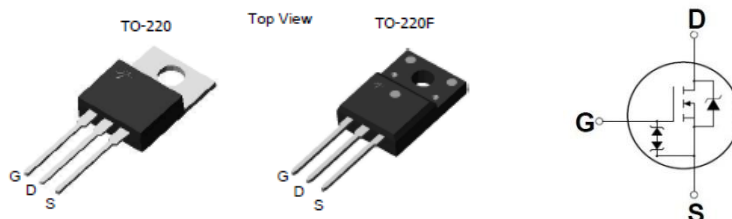

| Device                   | Package          | Marking                  | Remark       |
|--------------------------|------------------|--------------------------|--------------|
| TMP2N60AZ / TMPF2N60AZ   | TO-220 / TO-220F | TMP2N60AZ / TMPF2N60AZ   | RoHS         |
| TMP2N60AZG / TMPF2N60AZG | TO-220 / TO-220F | TMP2N60AZG / TMPF2N60AZG | Halogen Free |

## Absolute Maximum Ratings

| Parameter   | Symbol         | TMP2N60AZ(G)                      | TMPF2N60AZ(G) | Unit   |
|---|----------------|-----------------------------------|---------------|--------|
| Drain-Source Voltage  | $V_{DSS}$      | 600                               |               | V      |
| Gate-Source Voltage   | $V_{GS}$       | ±30                               |               | V      |
| Continuous Drain Current  | $I_D$          | $T_C = 25\text{ }^\circ\text{C}$  | 2.0           | 2.0 *  |
|   |                | $T_C = 100\text{ }^\circ\text{C}$ | 1.43          | 1.43 * |
| Pulsed Drain Current (Note 1)   | $I_{DM}$       | 8                                 | 8 *           | A      |
| Single Pulse Avalanche Energy (Note 2)  | $E_{AS}$       | 66                                |               | mJ     |
| Repetitive Avalanche Current (Note 1)   | $I_{AR}$       | 2.0                               |               | A      |
| Repetitive Avalanche Energy (Note 1)  | $E_{AR}$       | 5.21                              |               | mJ     |
| Power Dissipation   | $P_D$          | $T_C = 25\text{ }^\circ\text{C}$  | 52.1          | 17.3   |
|   |                | Derate above 25 °C                | 0.416         | 0.138  |
| Peak Diode Recovery dv/dt (Note 3)  | dv/dt          | 4.5                               |               | V/ns   |
| Operating Junction and Storage Temperature Range                              | $T_J, T_{STG}$ | -55~150                           |               | °C     |
| Maximum lead temperature for soldering purposes, 1/8" from case for 5 seconds | $T_L$          | 300                               |               | °C     |

\* Limited only by maximum junction temperature

## Thermal Characteristics

| Parameter                                       | Symbol          | TMP2N60AZ(G) | TMPF2N60AZ(G) | Unit |
|---|-----------------|--------------|---------------|------|
| Maximum Thermal resistance, Junction-to-Case    | $R_{\theta JC}$ | 2.4          | 7.2           | °C/W |
| Maximum Thermal resistance, Junction-to-Ambient | $R_{\theta JA}$ | 62.5         | 62.5          | °C/W |

**Electrical Characteristics :  $T_C=25^\circ\text{C}$ , unless otherwise noted**

| Parameter                           | Symbol     | Test condition                                   | Min | Typ | Max  | Units         |
|-------------------------------------|------------|--|-----|-----|------|---------------|
| <b>OFF</b>                          |            |  |     |     |      |               |
| Drain-Source Breakdown Voltage      | $BV_{DSS}$ | $V_{GS} = 0\text{ V}, I_D = 250\ \mu\text{A}$    | 600 | --  | --   | V             |
| Zero Gate Voltage Drain Current     | $I_{DSS}$  | $V_{DS} = 600\text{ V}, V_{GS} = 0\text{ V}$     | --  | --  | 1    | $\mu\text{A}$ |
|                                     |            | $V_{DS} = 480\text{ V}, T_C = 125^\circ\text{C}$ | --  | --  | 10   | $\mu\text{A}$ |
| Forward Gate-Source Leakage Current | $I_{GSSF}$ | $V_{GS} = 30\text{ V}, V_{DS} = 0\text{ V}$      | --  | --  | 100  | $\mu\text{A}$ |
| Reverse Gate-Source Leakage Current | $I_{GSSR}$ | $V_{GS} = -30\text{ V}, V_{DS} = 0\text{ V}$     | --  | --  | -100 | $\mu\text{A}$ |

**ON**

|  |              |  |    |     |     |          |
|--|--------------|--|----|-----|-----|----------|
| Gate Threshold Voltage                       | $V_{GS(th)}$ | $V_{DS} = V_{GS}, I_D = 250\ \mu\text{A}$  | 3  | --  | 5   | V        |
| Drain-Source On-Resistance                   | $R_{DS(on)}$ | $V_{GS} = 10\text{ V}, I_D = 1.0\text{ A}$ | -- | 3.2 | 4.0 | $\Omega$ |
| Forward Transconductance <sup>(Note 4)</sup> | $g_{FS}$     | $V_{DS} = 30\text{ V}, I_D = 1.0\text{ A}$ | -- | 3   | --  | S        |

**DYNAMIC**

|                              |           |  |    |     |    |    |
|------------------------------|-----------|--|----|-----|----|----|
| Input Capacitance            | $C_{iss}$ | $V_{DS} = 25\text{ V}, V_{GS} = 0\text{ V},$<br>$f = 1.0\text{ MHz}$ | -- | 360 | -- | pF |
| Output Capacitance           | $C_{oss}$ |  | -- | 41  | -- | pF |
| Reverse Transfer Capacitance | $C_{rss}$ |  | -- | 7   | -- | pF |

**SWITCHING**

|   |              |  |    |    |    |    |
|---|--------------|--|----|----|----|----|
| Turn-On Delay Time <sup>(Note 4,5)</sup>  | $t_{d(on)}$  | $V_{DD} = 300\text{ V}, I_D = 2.0\text{ A},$<br>$R_G = 25\ \Omega, V_{GS} = 10\text{ V}$ | -- | 20 | -- | ns |
| Turn-On Rise Time <sup>(Note 4,5)</sup>   | $t_r$        |  | -- | 23 | -- | ns |
| Turn-Off Delay Time <sup>(Note 4,5)</sup> | $t_{d(off)}$ |  | -- | 42 | -- | ns |
| Turn-Off Fall Time <sup>(Note 4,5)</sup>  | $t_f$        |  | -- | 20 | -- | ns |
| Total Gate Charge <sup>(Note 4,5)</sup>   | $Q_g$        | $V_{DS} = 480\text{ V}, I_D = 2.0\text{ A},$<br>$V_{GS} = 10\text{ V}$                   | -- | 9  | -- | nC |
| Gate-Source Charge <sup>(Note 4,5)</sup>  | $Q_{gs}$     |  | -- | 2  | -- | nC |
| Gate-Drain Charge <sup>(Note 4,5)</sup>   | $Q_{gd}$     |  | -- | 4  | -- | nC |

**SOURCE DRAIN DIODE**

|   |          |   |    |     |     |               |
|---|----------|---|----|-----|-----|---------------|
| Maximum Continuous Drain-Source Diode Forward Current | $I_S$    | ----  | -- | --  | 2.0 | A             |
| Maximum Pulsed Drain-Source Diode Forward Current     | $I_{SM}$ | ----  | -- | --  | 8   | A             |
| Drain-Source Diode Forward Voltage                    | $V_{SD}$ | $V_{GS} = 0\text{ V}, I_S = 2.0\text{ A}$   | -- | --  | 1.5 | V             |
| Reverse Recovery Time <sup>(Note 4)</sup>             | $t_{rr}$ | $V_{GS} = 0\text{ V}, I_S = 2.0\text{ A}$<br>$di_F / dt = 100\text{ A}/\mu\text{s}$ | -- | 240 | --  | ns            |
| Reverse Recovery Charge <sup>(Note 4)</sup>           | $Q_{rr}$ |   | -- | 0.8 | --  | $\mu\text{C}$ |

Note :

1. Repeated rating : Pulse width limited by safe operating area
2.  $L=30.5\text{mH}, I_{AS} = 2.0\text{A}, V_{DD} = 50\text{V}, R_G = 25\Omega$ , Starting  $T_J = 25^\circ\text{C}$
3.  $I_{SD} \leq 2.0\text{A}, di/dt \leq 200\text{A}/\mu\text{s}, V_{DD} \leq BV_{DS}$ , Starting  $T_J = 25^\circ\text{C}$
4. Pulse Test : Pulse width  $\leq 300\mu\text{s}$ , Duty Cycle  $\leq 2\%$
5. Essentially Independent of Operating Temperature Typical Characteristics

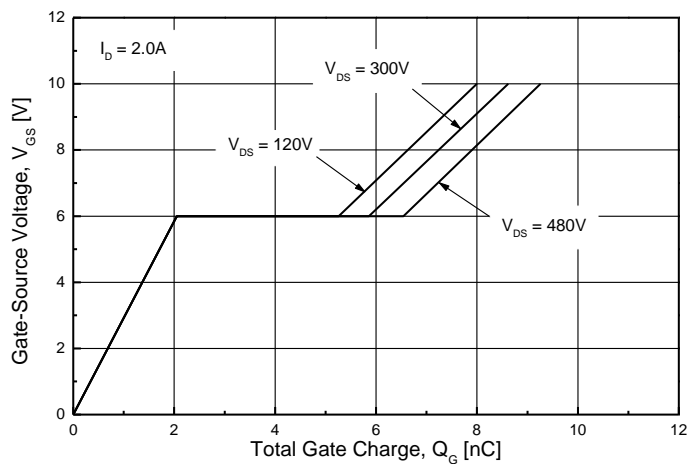
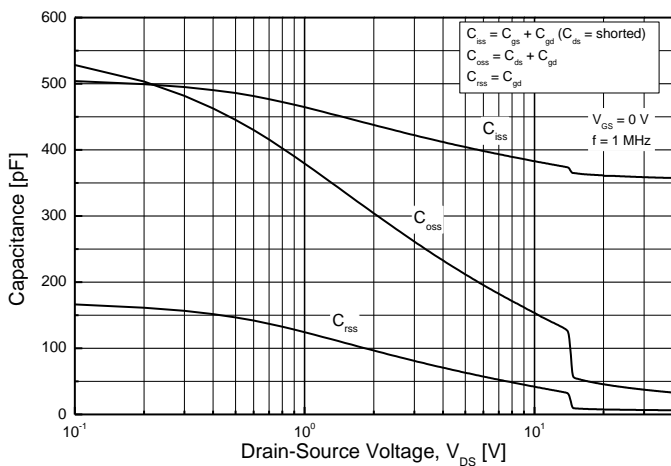
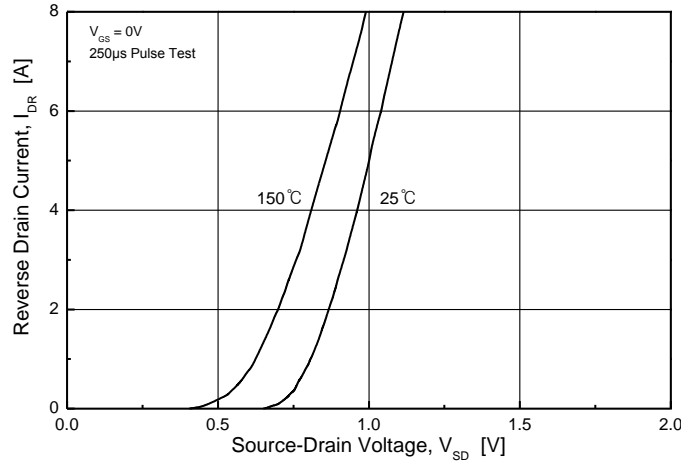
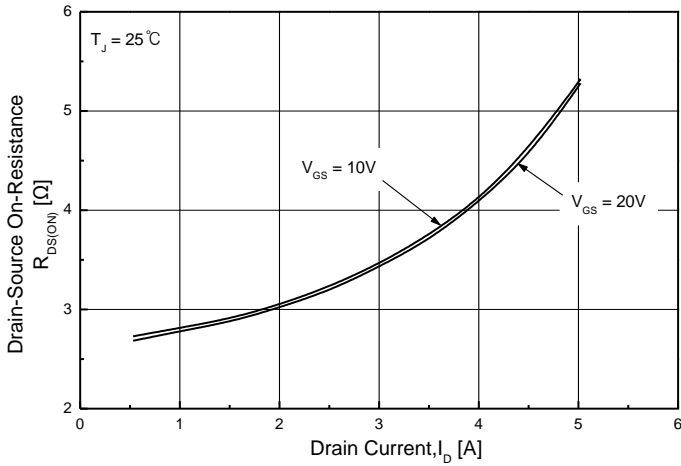
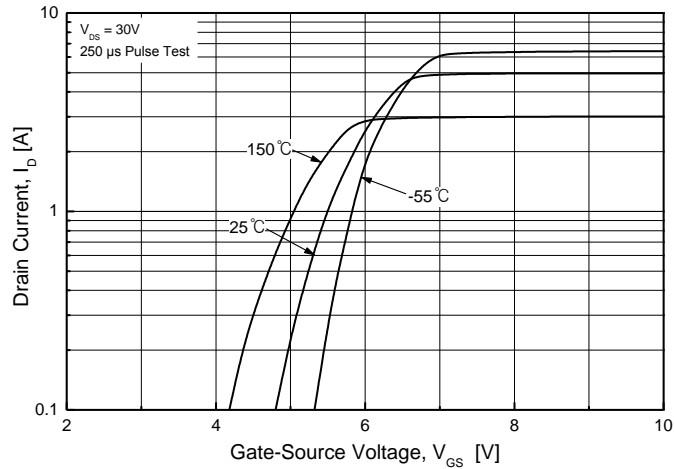
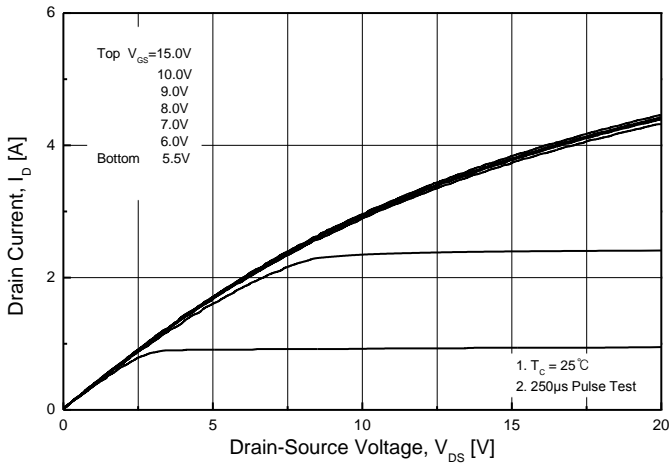

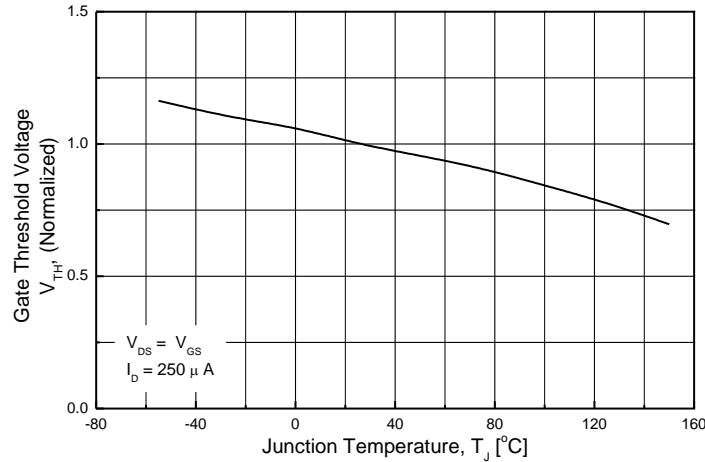
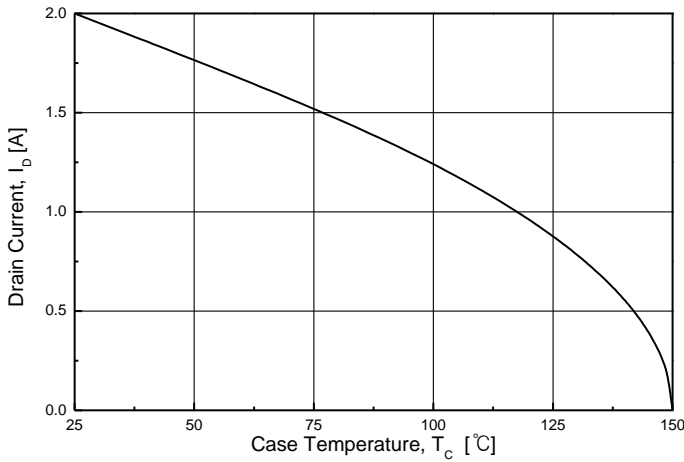
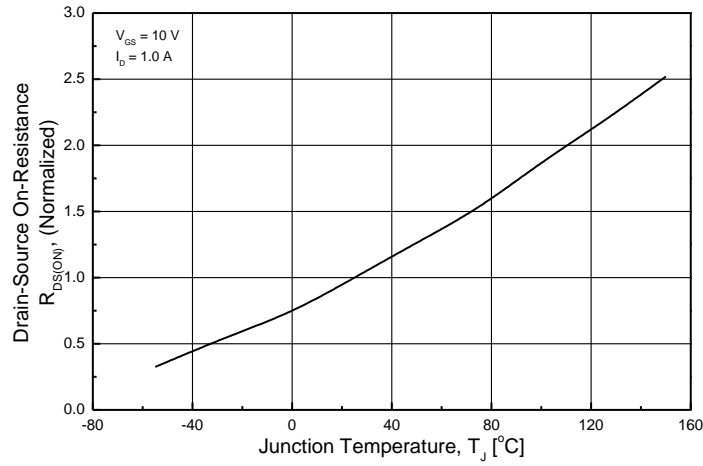
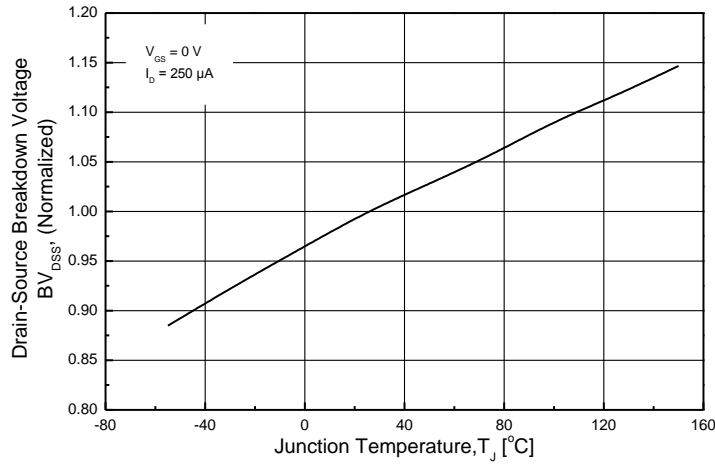

**TMP2N60AZ(G)**

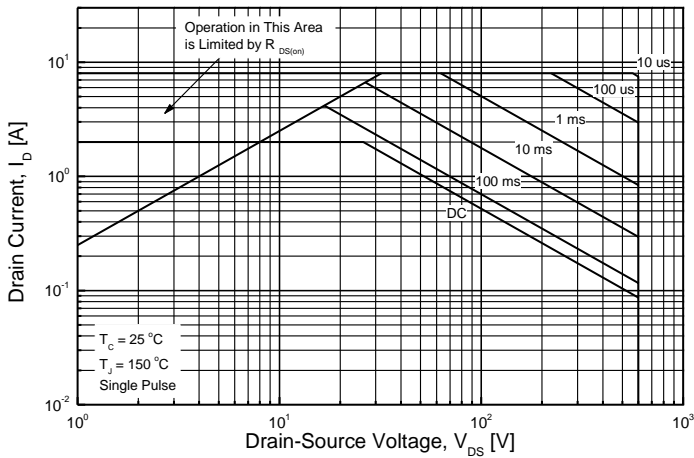

**TMPF2N60AZ(G)**

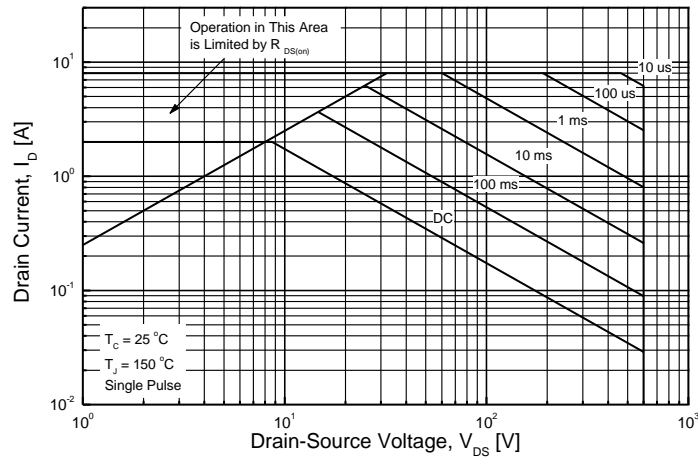

**TMP2N60AZ(G)**

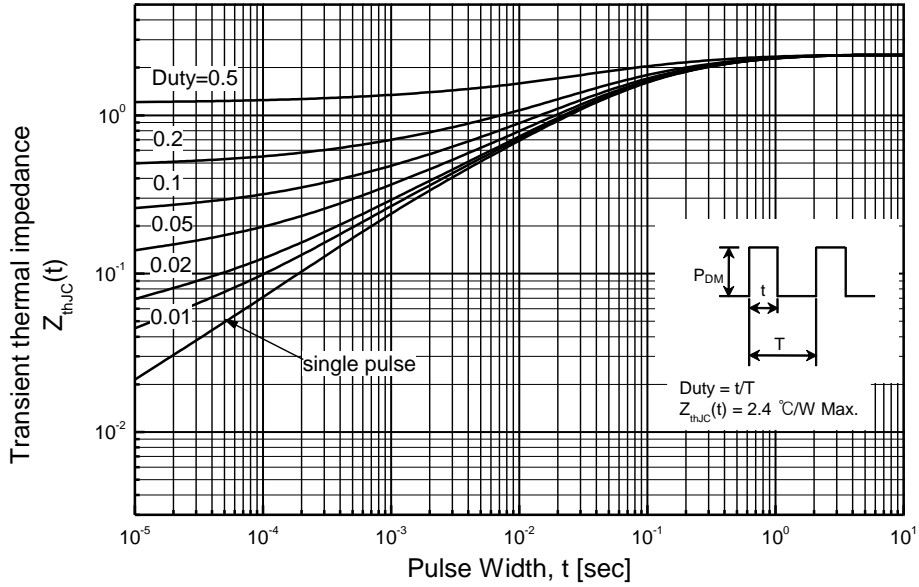

**TMPF2N60AZ(G)**

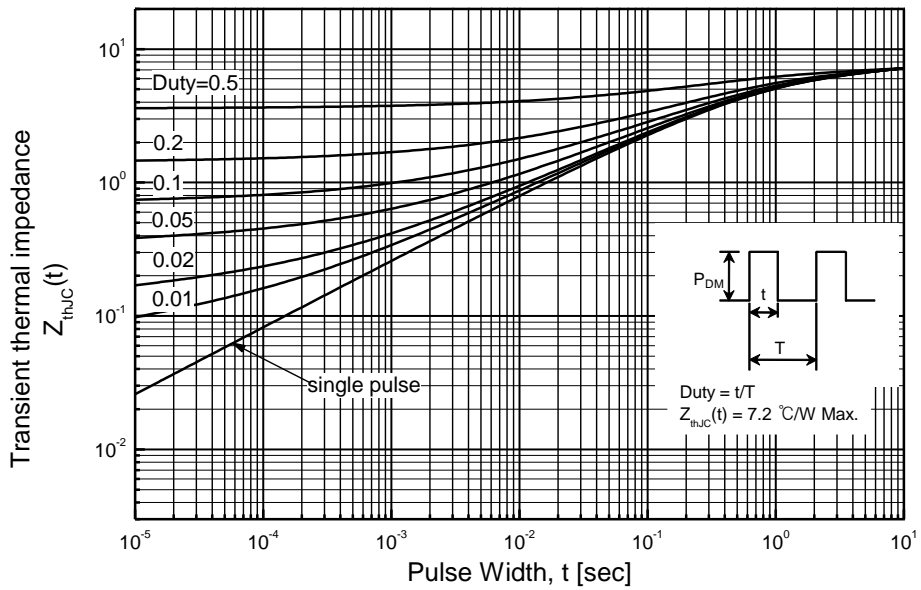

TO-220AB-3L MECHANICAL DATA

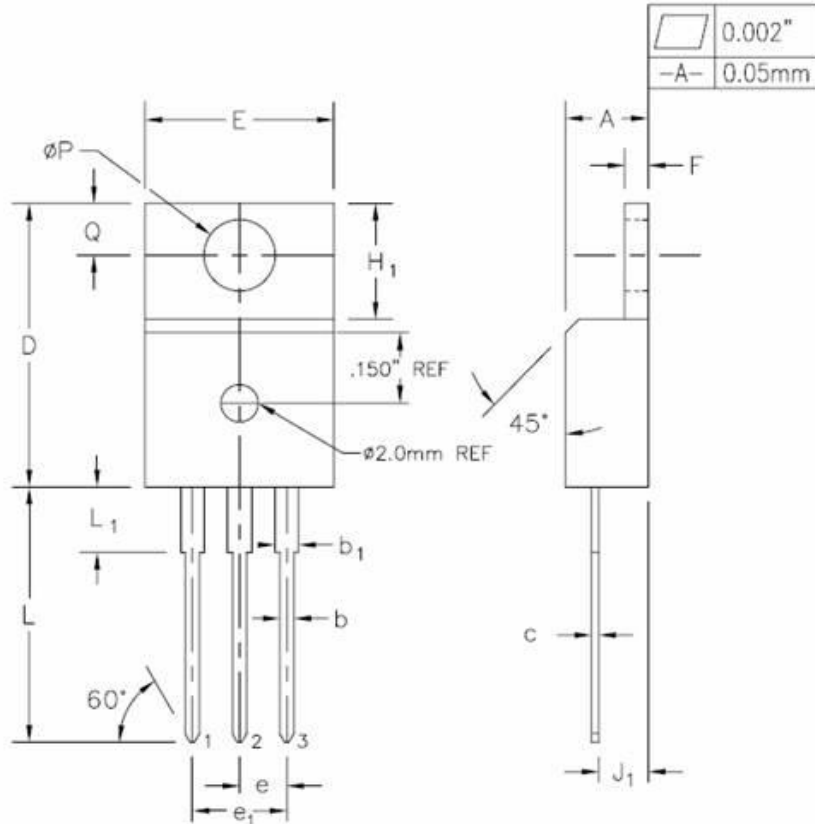

| SYMBOL         | INCHES     |       | MILLIMETERS |       | NOTES |
|----------------|------------|-------|-------------|-------|-------|
|                | MIN.       | MAX.  | MIN.        | MAX.  |       |
| A              | 0.170      | 0.180 | 4.32        | 4.57  |       |
| b              | 0.028      | 0.036 | 0.71        | 0.91  |       |
| b <sub>1</sub> | 0.045      | 0.055 | 1.15        | 1.39  |       |
| c              | 0.014      | 0.021 | 0.36        | 0.53  |       |
| D              | 0.590      | 0.610 | 14.99       | 15.49 |       |
| E              | 0.395      | 0.410 | 10.04       | 10.41 |       |
| e              | 0.100 TYP. |       | 2.54 TYP.   |       |       |
| e <sub>1</sub> | 0.200 BSC  |       | 5.08 BSC    |       |       |
| F              | 0.048      | 0.054 | 1.22        | 1.37  |       |
| H <sub>1</sub> | 0.235      | 0.255 | 5.97        | 6.47  |       |
| J <sub>1</sub> | 0.100      | 0.110 | 2.54        | 2.79  |       |
| L              | 0.530      | 0.550 | 13.47       | 13.97 |       |
| L <sub>1</sub> | 0.130      | 0.150 | 3.31        | 3.81  | 2     |
| ∅P             | 0.149      | 0.153 | 3.79        | 3.88  |       |
| Q              | 0.102      | 0.112 | 2.60        | 2.84  |       |

TO-220F-3L MECHANICAL DATA

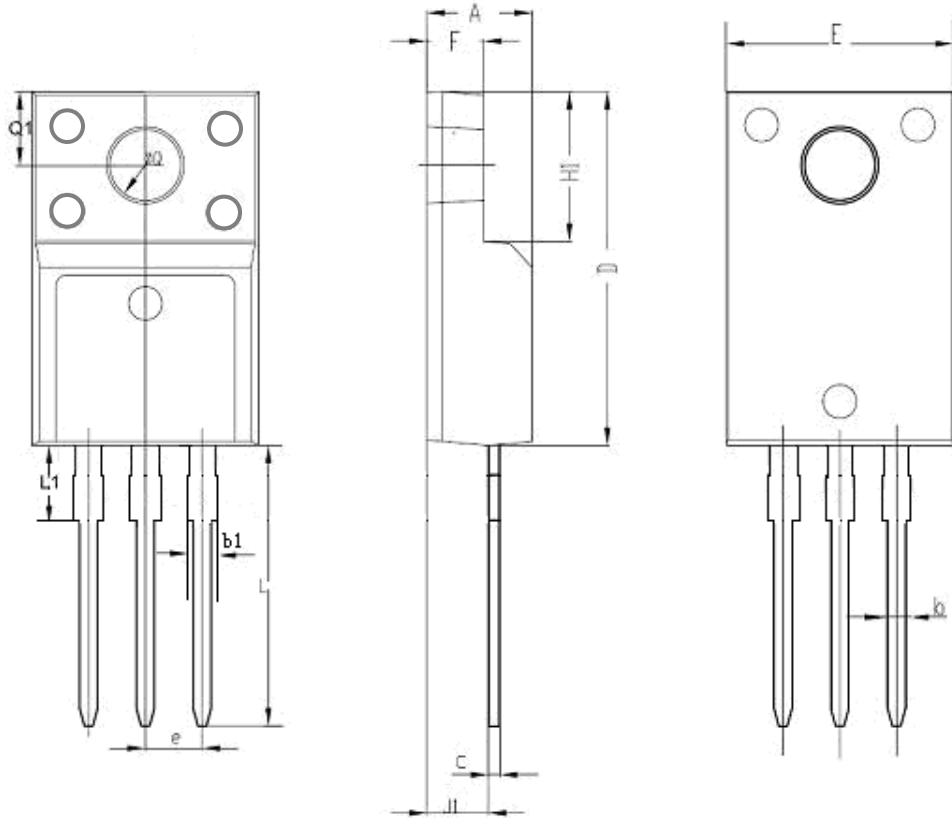

| SYMBOL | INCHES     |       | MILLIMETERS |       | NOTES |
|--------|------------|-------|-------------|-------|-------|
|        | MIN        | MAX   | MIN         | MAX   |       |
| A      | 0.178      | 0.194 | 4.53        | 4.93  |       |
| b      | 0.028      | 0.036 | 0.71        | 0.91  |       |
| C      | 0.018      | 0.024 | 0.45        | 0.60  |       |
| D      | 0.617      | 0.633 | 15.67       | 16.07 |       |
| E      | 0.392      | 0.408 | 9.96        | 10.36 |       |
| e      | 0.100 TYP. |       | 2.54TYP.    |       |       |
| H1     | 0.256      | 0.272 | 6.50        | 6.90  |       |
| J1     | 0.101      | 0.117 | 2.56        | 2.96  |       |
| L      | 0.503      | 0.519 | 12.78       | 13.18 |       |
| φQ     | 0.117      | 0.133 | 2.98        | 3.38  |       |
| b1     | 0.045      | 0.055 | 1.15        | 1.39  |       |
| L1     | 0.114      | 0.130 | 2.9         | 3.3   |       |
| Q1     | 0.122      | 0.138 | 3.10        | 3.50  |       |
| F      | 0.092      | 0.108 | 2.34        | 2.74  |       |