

## CMOS 4-BIT MICROCONTROLLER

## TMP42C66P

The 42C66 is a compact and high speed 4-bit single chip microcomputer with pulse output and zero-cross detection input and based on the TLC5-42 CMOS series, and provides high current output capability for LED direct drive.

The 42C66 is suitable for control of home appliances (such as fans, air-conditioners, refrigerators), audio equipments, remote control transmitter, games, and toys.

PART No.	ROM	RAM	PACKAGE	PIGGYBACK BOARD
TMP42C66P	1024 × 8-bit	32 × 4-bit	DIP20	BM4212A

## FEATURES

- ◆ 4-bit single chip microcomputer
- ◆ Instruction execution time :
  - 1.0 $\mu$ s (at 5MHz, 4.5 to 6.0V)
  - 2.5 $\mu$ s (at 2MHz, 4.0 to 6.0V)
- ◆ 44 basic instructions
  - All instructions are one byte object code
  - Table look-up instructions
- ◆ Stack for subroutine call : 1 level
- ◆ I/O port (15 pins)
  - I/O 3ports 11pins (Programmable I/O)
  - Input 1port 1pin
  - Output 1port 3pins
- ◆ Interval Timer (14 stages)
- ◆ High current outputs (8 pins)  
LED or Triac direct drive is available.
- ◆ Pulse output
  - Piezo buzzer drive output
  - Remote control carrier output
- ◆ Zero-cross detection input
- ◆ Hold function  
Battery/Capacitor back-up
- ◆ Clock generator  
Ceramic resonator/RC oscillation (mask option)
- ◆ Real Time Emulator: BM4221A

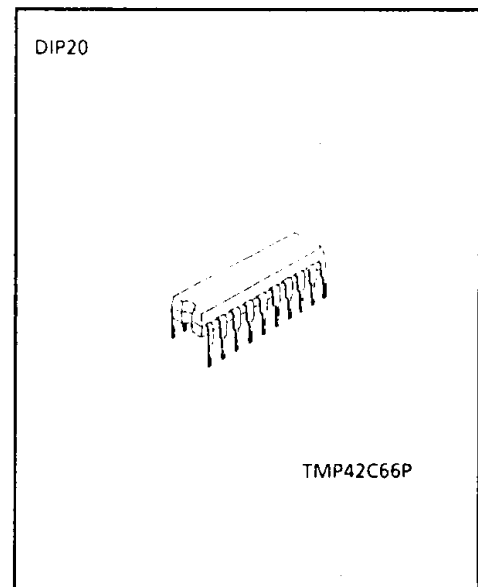

PIN ASSIGNMENT (TOP VIEW)

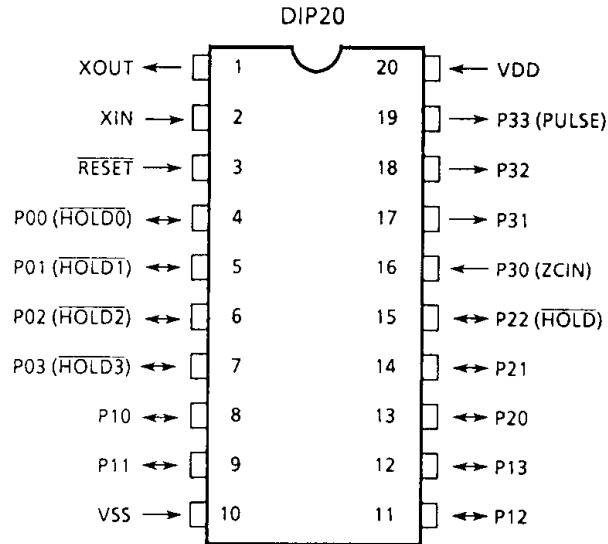

BLOCK DIAGRAM

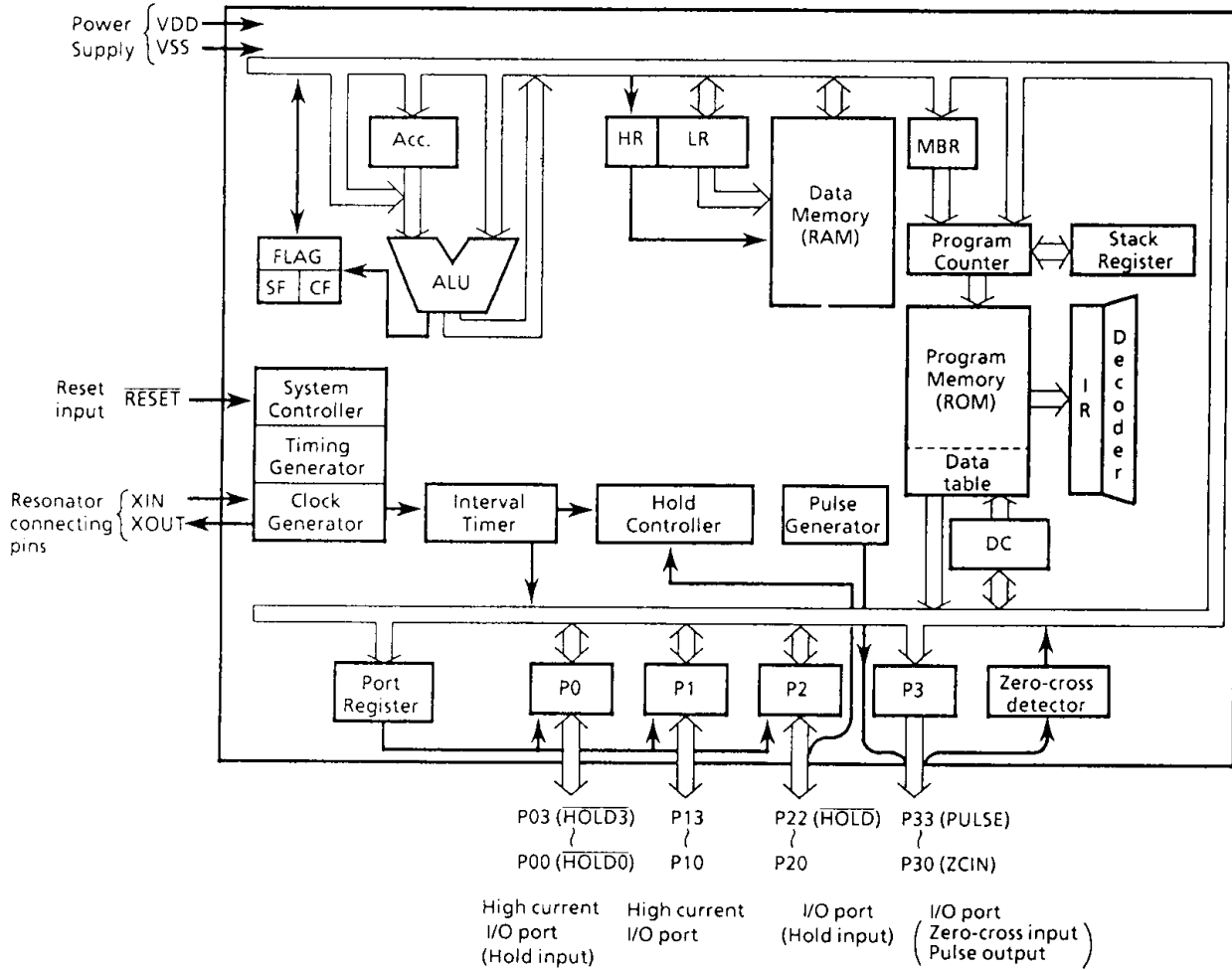

PIN FUNCTION

PIN NAME	Input/Output	FUNCTIONS	
P03 (HOLD $\bar{3}$ ) - P00 (HOLD $\bar{0}$ )	I/O (Input)	4-bit programmable I/O ports with latch, input/output mode can be specified by	Hold request / release signal input
P13 - P10	I/O	[MOV A, P] instruction.	
P22 (HOLD $\bar{2}$ )	I/O (Input)	3-bit programmable I/O ports with latch.	Hold request / release signal input
P21	I/O	The four input/output modes can be selected with an I/O control instruction [MOV A, P].	
P20			
P33 (PULSE)	Output (Output)	3-bit output port with latch	Pulse output (high current)
P32	Output		
P31			
P30 (ZCIN)	Input (Input)	1-bit input port	Zero-cross detection input
XIN	Input	Resonator connecting pins.	
XOUT	Output	For inputting external clock, XIN is used XOUT is opened.	
RESET	Input	Reset signal input	
VDD	Power Supply	+ 5V	
VSS		0V (GND)	

OPERATIONAL DESCRIPTION

Concerning the 42C66, the configuration and functions of hardware are described. As the description has been provided with priority on those parts differing from the 42C60, the technical data sheets for the 42C60 shall also be referred to.

1. SYSTEM CONFIGURATION

- (1) I/O ports
- (2) Pulse Generator
- (3) Zero-cross detector
- (4) Hold Controller

Concerning the above component parts, the configuration and functions of hardware are described.

2. PERIPHERAL HARDWARE FUNCTION

2.1 I/O ports

The 42C66 has 4 I/O ports (15 pins) each as follows :

- ① P0, P1 ; 4-bit programmable I/O (Port P0 is shared by hold request/release signal input)
- ② P2 ; 3-bit programmable I/O (P22 pin is shared by hold request/release signal input)
- ③ P3 ; 3-bit output (P33 pin is shared by pulse output)  
1-bit input (P30 pin is shared by zero-cross detection input)

- (1) Ports P0 (P03-P00), P1 (P13-P10)

Ports P0 and P1 are 4-bit programmable input/output ports with latches, and these are high current outputs which can directly drive LEDs. The latch is initialized to "1" during reset. Port P0 (P03-P00) is also used for hold operation release signal input (HOLD $\bar{3}$ -HOLD $\bar{0}$ ).

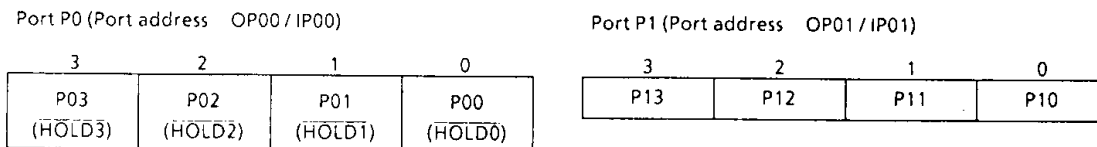

Figure 2-1. Ports P0 and P1

- (2) Port P3 (P33-P30)

Port P3 consists of 3-bit output ports with latch (P33-P31) and a 1-bit input port (P30). The latch is initialized to "1" during reset.

P33 pin is also used for pulse output (PULSE) and is a high current output pin.

P30 pin is for zero-cross detection input (ZCIN).

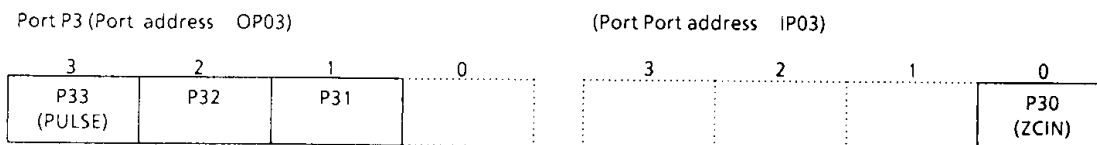

Figure 2-2. Port P3

## 2.2 Pulse Generator

Pulse output is used for buzzer drive, and remote control carrier.

The pulse output (PULSE) pin is also used as P33 pin. P33 (PULSE) pin has a high current capable of driving NPN transistor bases during carrier output for remote control transmitting, and operating infrared LEDs. Pulse output is asynchronous.

### 2.2.1 Circuit Configuration

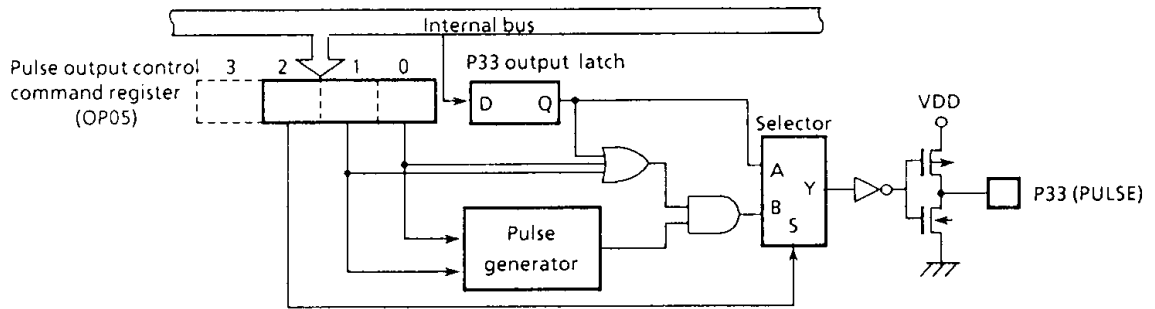

Figure 2-3. Pulse generator

### 2.2.2 Control of Pulse output

Pulse output is controlled by the command register (OP05). The command register is initialized to "0100<sub>8</sub>" during reset; therefore, pulse output is halted and latch data are output to P33 pin.

Example1 : A buzzer drive pulse of approximately 1KHz is output (at  $f_c = 2\text{MHz}$ ) from PULSE pin.

```
LD    A, #0011B      ; OP05←00118
OUT   A, %OP05
```

Example2 : A remote control transmitter carrier pulse of 37.9KHz is output (at  $f_c = 455\text{KHz}$ ) from P33 (PULSE) pin.

```
LD    A, #0000B      ; OP05←00008
OUT   A, %OP05
LD    A, #1000B      ; P33 output Latch←1
OUT   A, %OP03
```

Pulse Output Control Command Register (Port address OP05)

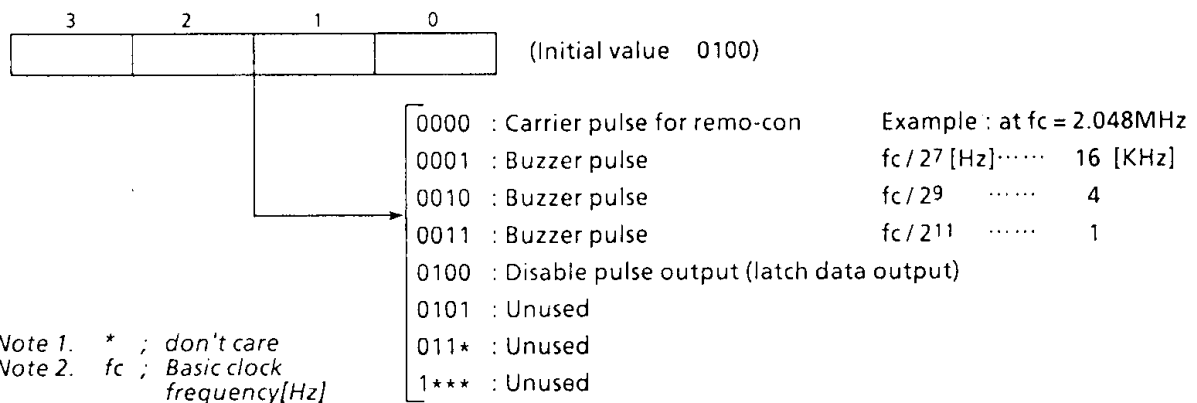

Note 1. \* ; don't care  
 Note 2.  $f_c$  ; Basic clock frequency[Hz]

Figure 2-4. Pulse Output Control Command Register

(1) Buzzer pulse

The buzzer pluses of the 42C66 consists of three different outputs obtained by dividing the basic clock.

The output type can be selected by the program. Buzzer pulses are not affected by P33 latch data and pulse output starts immediately after a command is loaded to the command register (OP05) by an output instruction.

Note. When a piezoelectric buzzer is connected to the pin, voltage may be generated by the buzzer due to thermal or mechanical shock. In such cases, there is danger of the pin being destroyed so a zener diode should always be connected for protection.

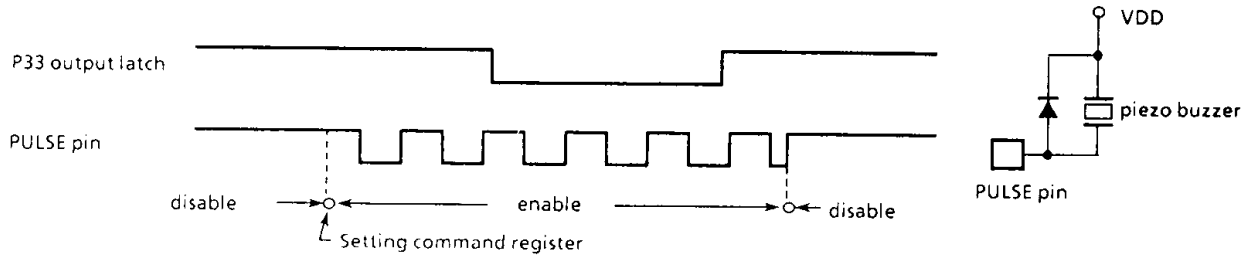

Figure 2-5. Timing chart and circuit example of buzzer pulse

(2) Carrier pulse for remote control signal transmitter

A basic clock frequency of 455kHz is recommended when the 42C66 is used for remote control transmitting. At such times, the remote control transmitting carrier has a frequency of 37.9 kHz (1/3 duty), which is the basic clock (CP : frequency  $f_c$ [Hz]) divided by 12. Also, the remote control transmitting carrier is output only when the P33 latch data is "1" "Low" level is output when the latch data is "0"

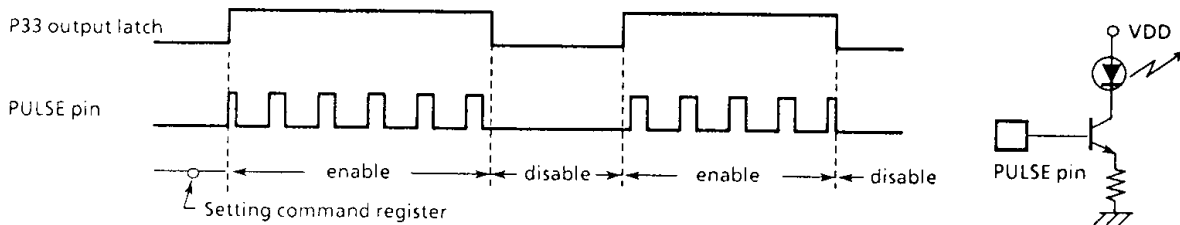

Figure 2-6. Timing chart and circuit example of carrier pulse for Remo-con

2.3 Zero-cross detector

P30 pin is used for zero-cross detection input (ZCIN) and zero-cross detection can be performed by connecting an external capacitor. This function can be used for commercial power supply frequency (AC 50 / 60Hz) input, and time base or triac control. The zero-cross detector is disabled and P30 pin is set to high level during the hold operating mode.

When driving P30 (ZCIN) pin directly without using an external capacitor, P30 is used for normal digital input.

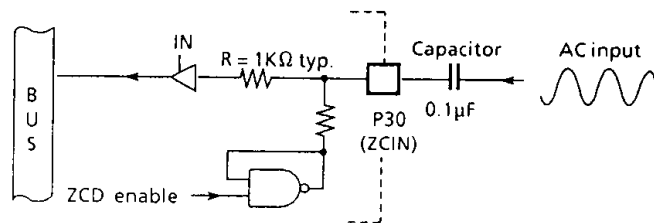

Figure 2-7. Zero-cross detector

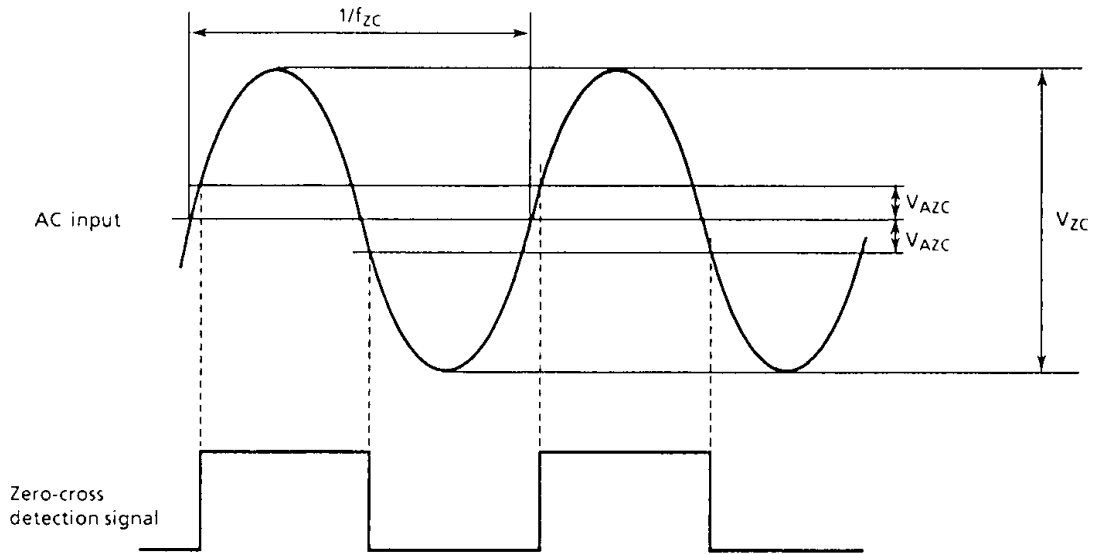

Figure 2-8. Zero-cross detection signal

**3. POWER SAVING FUNCTION**

The 42C66 has the hold operating mode intended to save the power.

**3.1 Hold Operating Mode**

The P0 (P00-P03) ports of the 42C66 are also used for hold operation release signal input ( $\overline{\text{HOLD0}}-\overline{\text{HOLD3}}$ )

Because of that, hold operation can be released and normal operation resumed by inputting the high level to one of the four P0 port pins or the P22 ( $\overline{\text{HOLD}}$ ) pin.

Consequently, when entering the hold operating mode, all of the hold operation release signal input pins must be set to the input mode and fixed at low level.

Hysteresis input is used for hold release signal input from P22 ( $\overline{\text{HOLD}}$ ) pin, but normal CMOS input is used for hold operation release signal input from pins P00 ( $\overline{\text{HOLD0}}$ ) - P03 ( $\overline{\text{HOLD3}}$ )

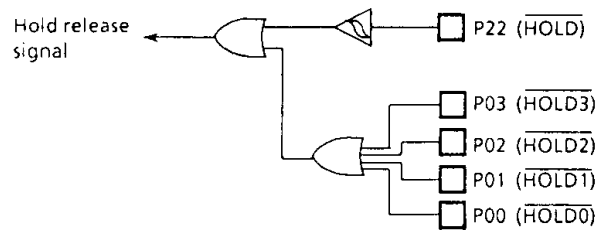

Figure 3-1. Hold control circuit

## ELECTRICAL CHARACTERISTICS

ABSOLUTE MAXIMUM RATINGS (V<sub>SS</sub> = 0V)

PARAMETER	SYMBOL	PIN	RATING	UNIT
Supply Voltage	V <sub>DD</sub>		- 0.5 to 7	V
Input Voltage	V <sub>IN</sub>		- 0.5 to V <sub>DD</sub> + 0.5	V
Output Voltage	V <sub>OUT</sub>		- 0.5 to V <sub>DD</sub> + 0.5	V
Output Current (total)	ΣI <sub>OUT</sub>		100	mA
Power Dissipation [T <sub>opr</sub> = 85°C]	PD		300	mW
Soldering Temperature (time)	T <sub>slid</sub>		260 (10sec)	°C
Storage Temperature	T <sub>stg</sub>		- 55 to 125	°C
Operating Temperature	T <sub>opr</sub>		- 40 to 85	°C

RECOMMENDED OPERATING CONDITIONS (V<sub>SS</sub> = 0V, T<sub>opr</sub> = - 40 to 85°C)

PARAMETER	SYMBOL	PIN	CONDITIONS	Min.	Max.	UNIT
Supply Voltage	V <sub>DD</sub>			4.0	6.0	V
Input High Voltage	V <sub>IH1</sub>	Except Hysteresis Input		V <sub>DD</sub> × 0.7	V <sub>DD</sub>	V
	V <sub>IH2</sub>	Hysteresis Input		V <sub>DD</sub> × 0.8		
Input Low Voltage	V <sub>IL1</sub>	Except Hysteresis Input		0	V <sub>DD</sub> × 0.3	V
	V <sub>IL2</sub>	Hysteresis Input			V <sub>DD</sub> × 0.2	
Clock Frequency	f <sub>c</sub>		V <sub>DD</sub> = 4.0 to 6.0V	0.2	2.0	MHz
			V <sub>DD</sub> = 4.5 to 6.0V		5.0	



## D.C. CHARACTERISTICS

(V<sub>SS</sub> = 0V, T<sub>opr</sub> = -40 to 85°C)

PARAMETER	SYMBOL	PIN	CONDITIONS	Min.	Typ.	Max.	UNIT
Hysteresis Voltage	V <sub>HS</sub>	Hysteresis Voltage		—	0.3	—	V
Input Current	I <sub>IN</sub>	P30 pin	V <sub>DD</sub> = 5V, V <sub>IN</sub> = 5V/0V	—	± 30	—	μA
Input High Current	I <sub>IH</sub>	Ports P0, P1, P2	V <sub>DD</sub> = 5V, V <sub>IN</sub> = 5V	15	30	80	μA
Input Resistance	R <sub>IN</sub>	$\overline{\text{RESET}}$		65	160	340	kΩ
Output High Voltage	V <sub>OH</sub>	Ports P0, P1, P2	V <sub>DD</sub> = 5V, I <sub>OH</sub> = -5μA	4.7	4.9	—	V
Output High Current	I <sub>OH1</sub>	P31, P32 pins	V <sub>DD</sub> = 4V, V <sub>OH</sub> = 2.4V	-1.0	-4.5	—	mA
	I <sub>OH2</sub>	P33 pin	V <sub>DD</sub> = 3V, V <sub>OH</sub> = 1.5V	-7.5	—	—	
Output Low Current	I <sub>OL1</sub>	Ports P2, P3	V <sub>DD</sub> = 4.5V, V <sub>OL</sub> = 0.4V	1.6	5.0	—	mA
	I <sub>OL2</sub>	Ports P0, P1	V <sub>DD</sub> = 4.5V, V <sub>OL</sub> = 1.2V	10	25	—	
Supply Current (In the Normal operating mode)	I <sub>DD</sub>		V <sub>DD</sub> = 6V, f <sub>c</sub> = 2MHz	—	0.8	3.0	mA
Supply Current (In the HOLD operating mode)	I <sub>DDH</sub>		V <sub>DD</sub> = 6V	—	0.1	5.0	μA

Note 1. Typ. values shows those at V<sub>DD</sub> = 5V, T<sub>opr</sub> = 25°C.

Note 2. Supply Current in the Normal operating mode :  $\overline{\text{RESET}}$  pin is 0V, and XOUT pin and ports are opened in the external clock operation.

Note 3. Supply Current in the Hold operating mode : All pins except the power supply pins (V<sub>DD</sub>, V<sub>SS</sub>) are opened.

## A.C. CHARACTERISTICS

(V<sub>SS</sub> = 0V, T<sub>opr</sub> = -40 to 85°C)

PARAMETER	SYMBOL	CONDITIONS		Min.	Typ.	Max.	UNIT
Instruction Cycle Time	t <sub>cy</sub>	V <sub>DD</sub> = 4.0 to 6.0V		2.5	—	25	μs
		V <sub>DD</sub> = 4.5 to 6.0V		1.0			
High level Clock pulse Width	t <sub>wCH</sub>	V <sub>IN</sub> = V <sub>IH</sub>	For external clock operation	100	—	—	ns
Low level Clock pulse Width	t <sub>wCL</sub>	V <sub>IN</sub> = V <sub>IL</sub>					

ZERO-CROSS DETECTION CHARACTERISTICS

PARAMETER	SYMBOL	CONDITIONS	Min.	Typ.	Max.	UNIT
Zero-cross detection Input Voltage	$V_{ZC}$	AC coupling ( $C = 0.1\mu F$ )	1.0	—	1.8	$V_{p,p}$
Zero-cross detection Accuracy	$V_{AZC}$	$f_{ZC} = 50$ to $60$ Hz (Sine Curve)	—	—	$\pm 135$	mV
Zero-cross detection Input Frequency	$f_{ZC}$		40	—	1000	Hz

RECOMMENDED OSCILLATING CONDITIONS

( $V_{SS} = 0V$ ,  $V_{DD} = 4.0$  to  $6.0V$ ,  $T_{opr} = -40$  to  $85^{\circ}C$ )

(1) Ceramic Resonator

5MHz ( $V_{DD} = 4.5$  to  $6.0V$ )

CSA5.00MG (MURATA)  $C_{XIN} = C_{XOUT} = 30pF$

2MHz

CSA2.00MG (MURATA)  $C_{XIN} = C_{XOUT} = 100pF$

1MHz

CSB1000D (MURATA)  $C_{XIN} = C_{XOUT} = 330pF$

455KHz

CSB455E (MURATA)  $C_{XIN} = C_{XOUT} = 220pF$ ,  $R_{XOUT} = 5.6K\Omega$

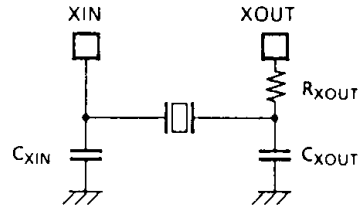
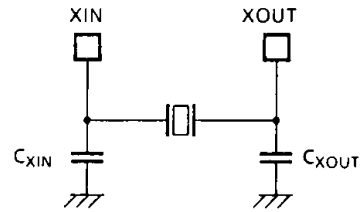

(2) RC oscillation

1MHz typ.

$R_X = 15K\Omega$ ,  $C_{XIN} = 100pF$

500KHz typ.

$R_X = 36K\Omega$ ,  $C_{XIN} = 100pF$

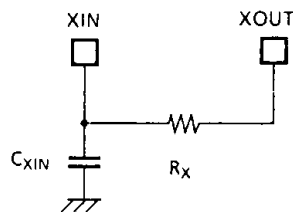

TYPICAL CHARACTERISTICS

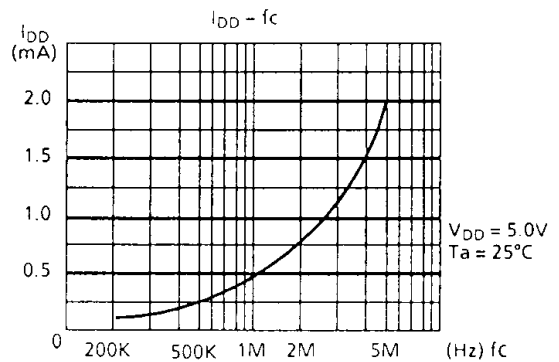
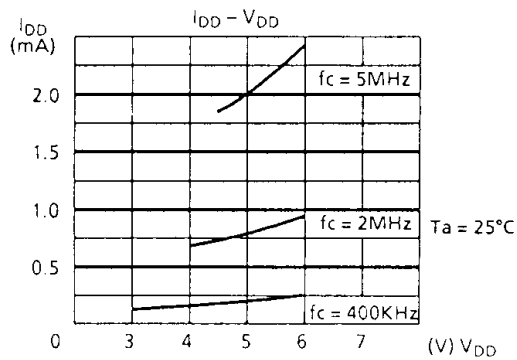
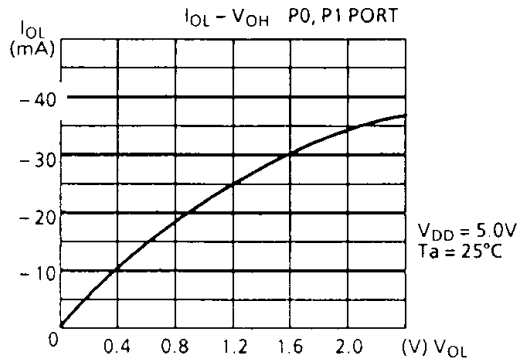
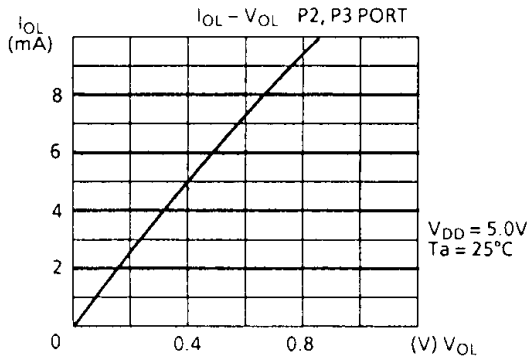
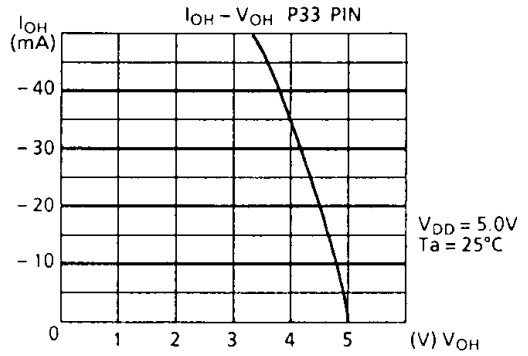
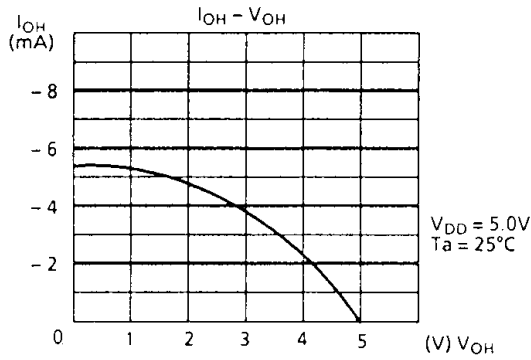
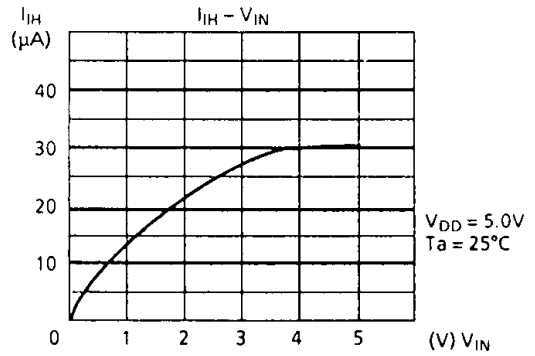
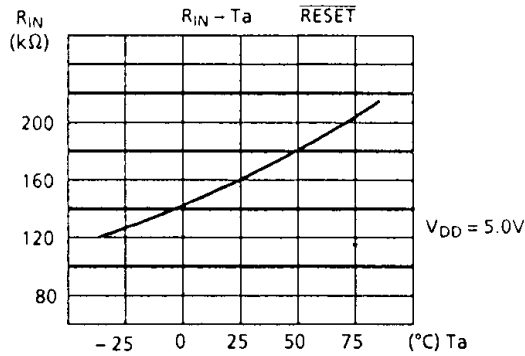

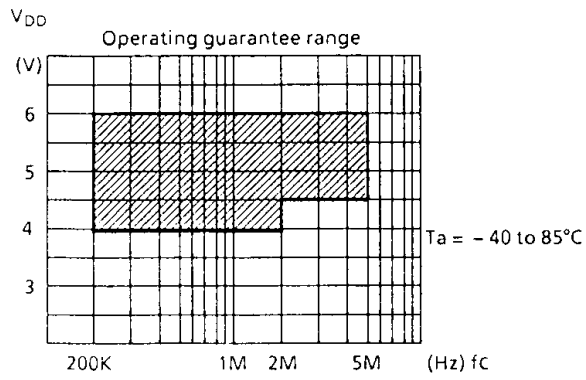
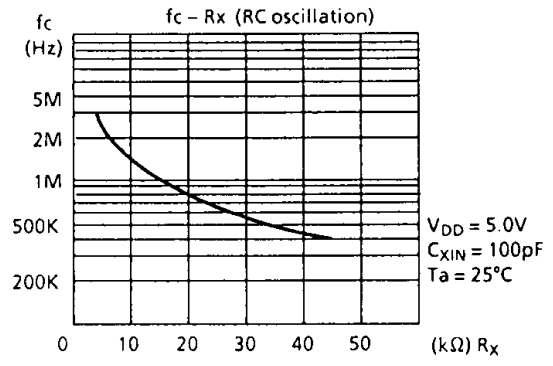
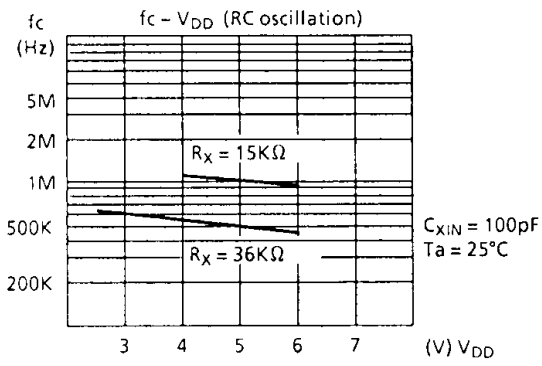

INPUT/OUTPUT CIRCUITRY

(1) Control pins

The input/output circuitries of the 42C66 control pins are shown below.

Oscillation type can be chosen by mask option either a ceramic resonator (external clock input) or an RC oscillator.

CONTROL PIN	I/O	CIRCUITRY	REMARKS
XIN XOUT	INPUT OUTPUT	<p>Option : Ceramic resonator/External clock input</p>	<p>Resonator connecting pins</p> <p><math>R = 1K\Omega</math> (typ.)  <math>R_f = 1M\Omega</math> (typ.)</p>
		<p>Option : RC oscillation</p>	<p>Resonator connecting pins</p> <p>Hysteresis input</p> <p><math>R = 1K\Omega</math> (typ.)  <math>R_f = 1M\Omega</math> (typ.)</p>
<u>RESET</u>	INPUT		<p>Hysteresis input</p> <p>Pull-up resistor</p> <p><math>R_{IN} = 160K\Omega</math> (typ.)  <math>R = 1K\Omega</math> (typ.)</p>

(2) I/O Ports

The input/output circuitries of the 42C66 I/O ports are shown below.

PORT	I/O	CIRCUITRY	INITIAL STATE	REMARKS
P0 P1 P2	I/O		Input	Programmable I/O port Input mode : Input with pull-down Output mode : Push-pull (Ports P0 and P1 are high current outputs) R = 1KΩ (typ.)
P3	Input		Input	P30 pin Zero-cross detection input R = 1KΩ (typ.)
	Output		High	P33 -P31 pins (P33 pin is high current output) Push-pull output