

CMOS 4-BIT MICROCONTROLLER

TMP42C50N, TMP42C70N
TMP42C50M, TMP42C70M

The 42C50/70 are high speed and 4-bit single chip microcomputers with added input/output ports and based on the TLCS-42 CMOS series.

The 42C50/70 are suitable for control of home appliances (such as fans, air-conditioners, refrigerators), audio equipments, games, and toys.

PART No.	ROM	RAM	PACKAGE	PIGGYBACK BOARD
TMP42C50N	512 x 8-bit	32 x 4-bit	SDIP28	BM4211B
TMP42C50M			SOP28	
TMP42C70N	1024 x 8-bit		SDIP28	
TMP42C70M			SOP28	

FEATURES

- ◆ 4-bit single chip microcomputer
- ◆ Instruction execution time :
 - 1.0μs (at 5MHz, 4.5 to 6.0V)
 - 2.5μs (at 2MHz, 4.0 to 6.0V)
- ◆ 44 basic instructions
 - All instructions are one byte object code
 - Table look-up instructions
- ◆ Stack for subroutine call : 1 level
- ◆ I/O port (23 pins)
 - I/O 3ports 11pins (Note 1)
 - I/O 2ports 8pins (Note 2)
 - Output 1port 4pins

(Note 1) Software programmable I/O ports
 (Note 2) Mask programmable I/O ports
- ◆ Interval Timer (14 stages)
- ◆ Hold function
 - Battery/Capacitor back-up
- ◆ Clock generator
 - Ceramic resonator/RC oscillation (mask option)
- ◆ Real Time Emulator : BM4221A

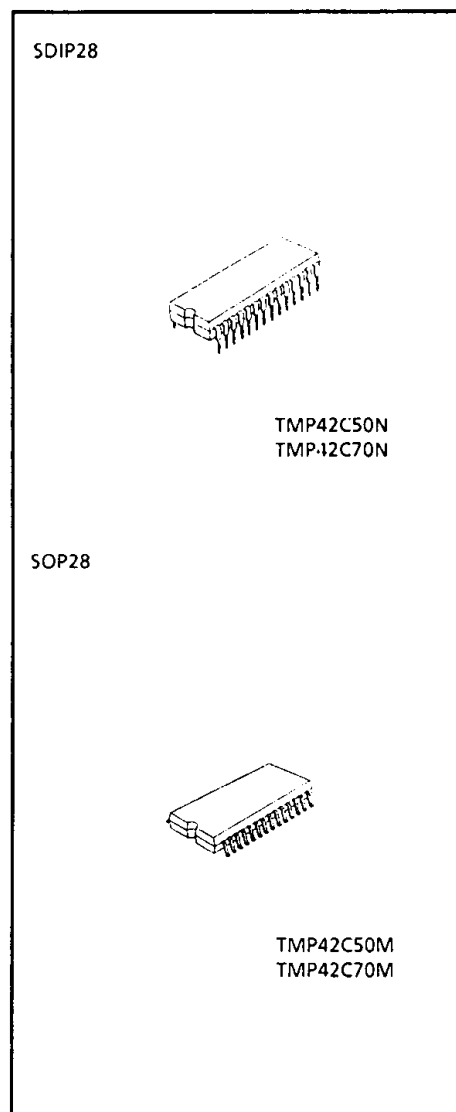

PIN ASSIGNMENTS (TOP VIEW)

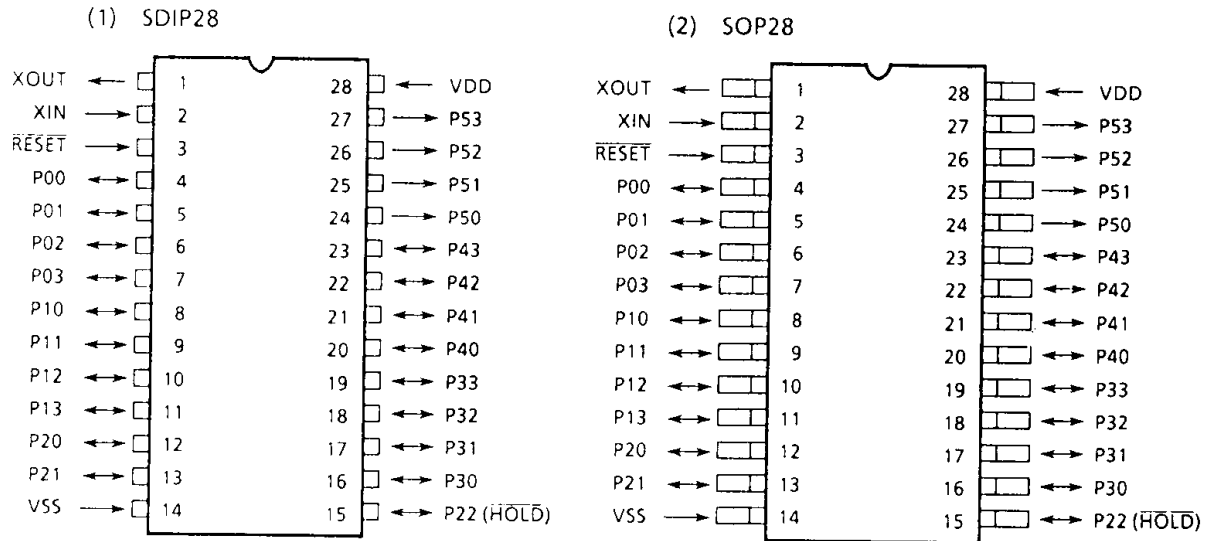

BLOCK DIAGRAM

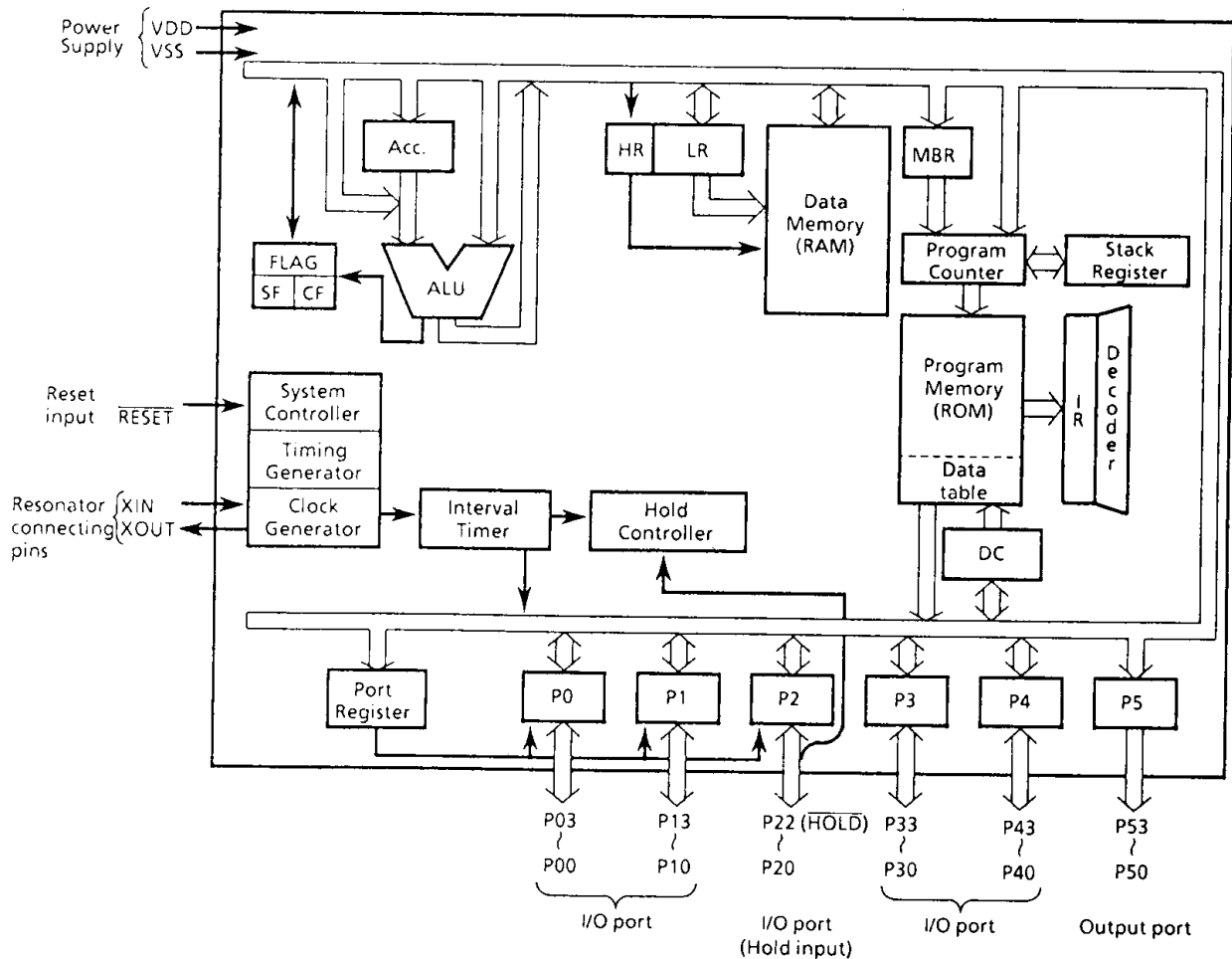

PIN FUNCTION

PIN NAME	INPUT/OUTPUT	FUNCTIONS	
P03 - P00	I/O	4-bit programmable I/O ports with latch, input/output mode can be specified by [MOV A, P] instruction.	
P13 - P10			
P22 ($\overline{\text{HOLD}}$)	I/O (INPUT)	3-bit programmable I/O port with latch. The four input/output modes can be selected with an I/O control instruction [MOV A, P].	Hold request/release signal input
P21	I/O		
P20			
P33 - P30	I/O	4-bit I/O ports with latch. Mask options make it possible to choose any of four different combinations for each port : input, output, or input/output.	
P43 - P40			
P53 - P50	OUTPUT	4-bit output port with latch	
XIN	INPUT	Resonator connecting pins. For inputting external clock, XIN is used, XOUT is opened.	
XOUT	OUTPUT		
RESET	INPUT	Reset signal input	
VDD	Power Supply	+ 5V	
VSS		0V (GND)	

OPERATIONAL DESCRIPTION

Due to mask options, the 42C40/60 are available as the 42C50/70 with a total of 3 additional ports (12 pins) : 2 ports that can select input/output circuit configuration and one dedicated output port. All else is exactly the same as for the 42C40/60. Refer to the 42C40/60 technical data sheet for details.

1. PERIPHERAL HARDWARE FUNCTION

1.1 I/O Ports

The 42C50/70 have 6 I/O ports (11 pins) each as follows:

- ① P0, P1 ; 4-bit programmable I/O
- ② P2 ; 3-bit programmable I/O (P22 pin is shared by hold request/release signal input pin.)
- ③ P3, P4 ; 4-bit I/O (mask option)
- ④ P5 ; 4-bit Output

The following explanation covers only ports ③ and ④ added to the 42C40/60. These ports do not have input latches, so external input data are either held externally until read, or are read several times before processing, when necessary.

(1) Ports P3 (P33-P30), P4 (P43-P40)

Any of the four input/output circuit configurations (A, B, C, D) shown in Table 1-1 can be selected for each of the 4-bit ports as a mask option.

Mask option code	P33-P30	P43-P40
A	Push-pull output	Push-pull output
B	Sink open drain output	Push-pull output
C	Sink open drain output	Sink open drain output
D	Input with pull-up resistor	Input with pull-up resistor

Table 1-1. Mask option for Ports P3 and P4



Figure 1-1. Ports P3 and P4

(2) Port P5 (P53-P50)

This is a 4-bit push-pull output port with latch. The latch is initialized to "1" during reset.

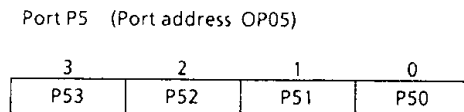

Figure 1-2. Port P5

1.1.1 Push-pull output

Data from the accumulator or data memory can be transferred to a latch or output from a pin by executing the output instructions [OUT A,%p] and [OUT @HL,%p].

The latch is initialized to "1" during reset.

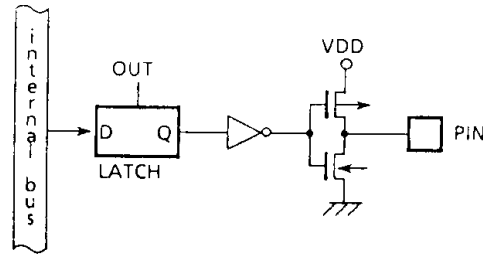

Figure 1-3. Circuitry of push-pull output port

1.1.2 Sink open drain output

To use for input, set the latch to "1" and use as a high-impedance port. External input data can then be read by executing the input instruction in that status (output transistor off).

To use for output, it is possible to change the output level by connecting an external pull-up resistor.

The latch is initialized to "1" during reset.

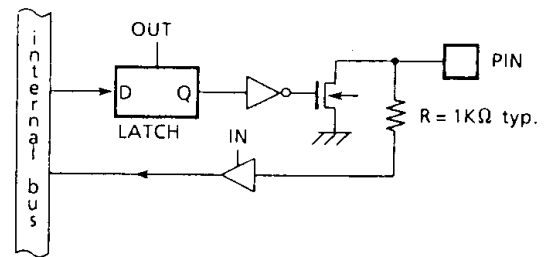

Figure 1-4. Circuitry of sink open drain output and input port

1.1.3 Input with pull-up resistor

This is an input-only port with a pull-up resistor. External input data can be read by executing the input instructions [IN %p, A] and [IN %p, @HL].

Note: Power consumption by the oscillation circuit and internal hardware is reduced during hold operation but power consumption by external circuit interfaces is not directly related to hold operation hardware operation, therefore, caution must be observed in system design and interface circuit design. For example, if the power supply voltage of an external circuit is dropped to 0V and the output is at high level, as for the push-pull output shown in Figure 1-6 (a), current may flow through the parasitic diodes of the external circuit in some cases. The relevant pin must be set to low level. Also, with input having a pull-up resistor as shown in Figure 1-6 (b), it is necessary to break the current path with a switch.

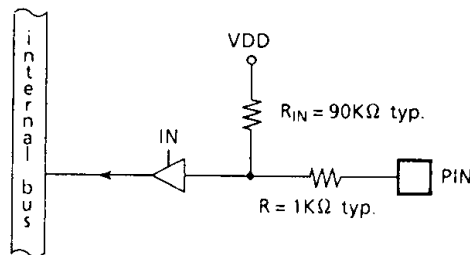

Figure 1-5. Circuitry of input port with pull-up resistor

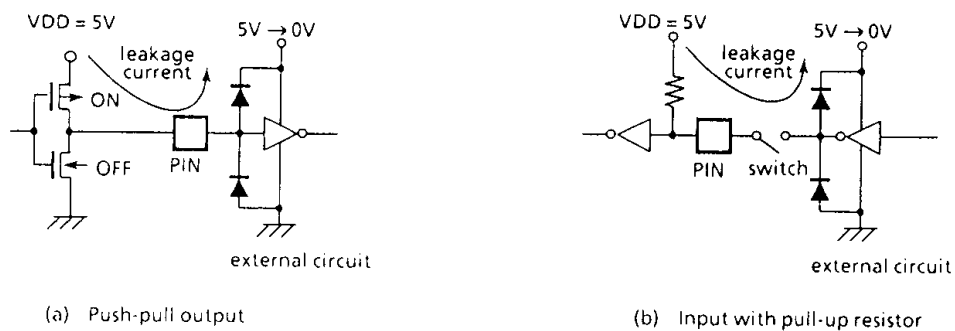

Figure 1-6. External circuit Interface during the Hold operating mode

ELECTRICAL CHARACTERISTICS

ABSOLUTE MAXIMUM RATINGS

(VSS = 0V)

PARAMETER	SYMBOL	PIN	RATING	UNIT
Supply Voltage	V _{DD}		- 0.5 to 7	V
Input Voltage	V _{IN}		- 0.5 to V _{DD} + 0.5	V
Output Voltage	V _{OUT1}	Except sink open drain output	- 0.5 to V _{DD} + 0.5	V
	V _{OUT2}	Sink open drain output	- 0.5 to 12	
Output Current (total)	ΣI _{OUT}		60	mA
Power Dissipation [T _{opr} = 85°C]	PD		300	mW
Soldering Temperature (time)	T _{sid}		260 (10sec)	°C
Storage Temperature	T _{stg}		- 55 to 125	°C
Operating Temperature	T _{opr}		- 40 to 85	°C

RECOMMENDED OPERATING CONDITIONS

(VSS = 0V, T_{opr} = - 40 to 85°C)

PARAMETER	SYMBOL	PIN	CONDITIONS	Min.	Min.	UNIT
Supply Voltage	V _{DD}			4.0	6.0	V
Input High Voltage	V _{IH1}	Except Hysteresis Input		V _{DD} × 0.7	V _{DD}	V
	V _{IH2}	Hysteresis Input		V _{DD} × 0.8		
Input Low Voltage	V _{IL1}	Except Hysteresis Input		0	V _{DD} × 0.3	V
	V _{IL2}	Hysteresis Input			V _{DD} × 0.2	
Clock Frequency	f _c		V _{DD} = 4.0 to 6.0V	0.2	2.0	MHz
			V _{DD} = 4.5 to 6.0V		5.0	

D.C. CHARACTERISTICS

(V_{SS} = 0V, T_{opr} = -40 to 85°C)

PARAMETER	SYMBOL	PIN	CONDITIONS	Min.	Typ.	Max.	UNIT
Hysteresis Voltage	V _{HS}	Hysteresis input		—	0.3	—	V
Input Current	I _{IN}	Open drain output	V _{DD} = 6V, V _{IN} = 0V	—	-10.5	-2.0	μA
High Input Current	I _{IH}	Ports P0, P1, P2	V _{DD} = 5V, V _{IN} = 5V	15	30	80	μA
Input Resistance	R _{IN1}	$\overline{\text{RESET}}$		65	160	340	KΩ
	R _{IN2}	Input with pull-up resistor		35	90	190	
Output Leakage Current	I _{LO}	Open drain output	V _{DD} = 6V, V _{OUT} = 6V	—	10.5	2.0	μA
Output High Voltage	V _{OH}	Push-pull output	V _{DD} = 5V, I _{OH} = -5μA	4.7	4.9	—	V
Output High Current	I _{OH}		V _{DD} = 4V, V _{OH} = 2.4V	-1.0	-4.5	—	mA
Output Low Current	I _{OL}	Ports P0-P5	V _{DD} = 4.5V, V _{OL} = 0.4V	1.6	5.0	—	mA
Supply Current (in the Normal operating mode)	I _{DD}		V _{DD} = 6V, f _c = 2MHz	—	0.8	3.0	mA
Supply Current (in the HOLD operating mode)	I _{DDH}		V _{DD} = 5V	—	0.1	5.0	μA

Note 1. Typ. values shows those at V_{DD} = 5V, T_{opr} = 25°C.

Note 2. Supply Current in the Normal operating mode: $\overline{\text{RESET}}$ pin is 0V, and XOUT pin and ports are opened in the external clock operation.

Note 3. Supply Current in the Hold operating mode : All pins other than the power supply pins (V_{DD}, V_{SS}) are open. This port is fixed at 0V when sink open drain pins are specified as by mask option.

A.C. CHARACTERISTICS

(V_{SS} = 0V, T_{opr} = -40 to 85°C)

PARAMETER	SYMBOL	CONDITIONS		Min.	Typ.	Max.	UNIT
Instruction Cycle Time	t _{cy}	V _{DD} = 4.0 to 6.0V		2.5	—	25	μs
		V _{DD} = 4.5 to 6.0V		1.0			
High level Clock pulse Width	t _{wCH}	V _{IN} = V _{IH}	For external clock operation	100	—	—	ns
Low level Clock pulse Width	t _{wCL}	V _{IN} = V _{IL}					

RECOMMENDED OSCILLATING CONDITIONS

($V_{SS} = 0V$, $V_{DD} = 4.0$ to $6.0V$, $T_{opr} = -40$ to $85^{\circ}C$)

(1) Ceramic Resonator

5MHz ($V_{DD} = 4.5$ to $6.0V$)
CSA5.00MG (MURATA) $C_{XIN} = C_{XOUT} = 30pF$

2MHz
CSA2.00MG (MURATA) $C_{XIN} = C_{XOUT} = 100pF$

1MHz
CSB1000D (MURATA) $C_{XIN} = C_{XOUT} = 330pF$

455KHz
CSB455E (MURATA) $C_{XIN} = C_{XOUT} = 220pF$, $R_{XOUT} = 5.6K\Omega$

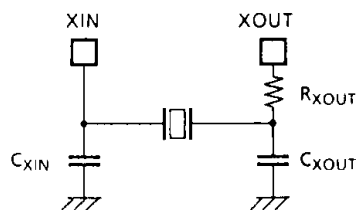
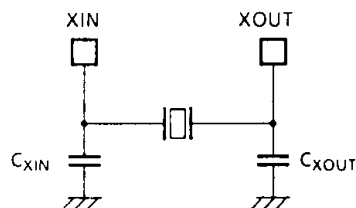

(2) RC Oscillation

1MHz typ. $R_X = 15K\Omega$, $C_{XIN} = 100pF$

500KHz typ. $R_X = 36K\Omega$, $C_{XIN} = 100pF$

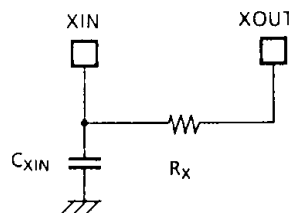

TYPICAL CHARACTERISTICS

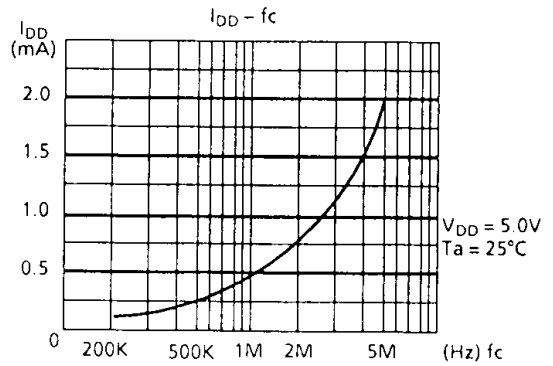
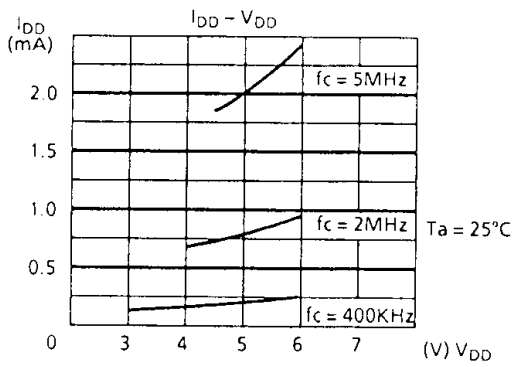
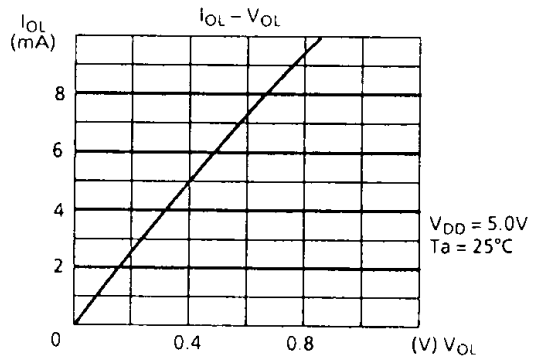
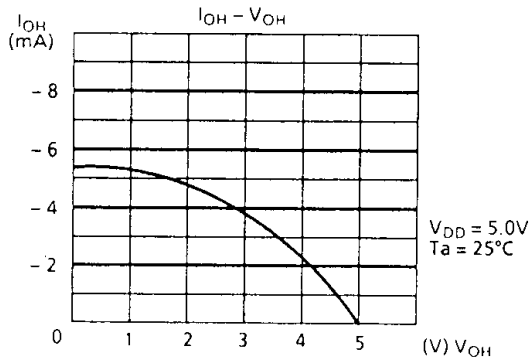
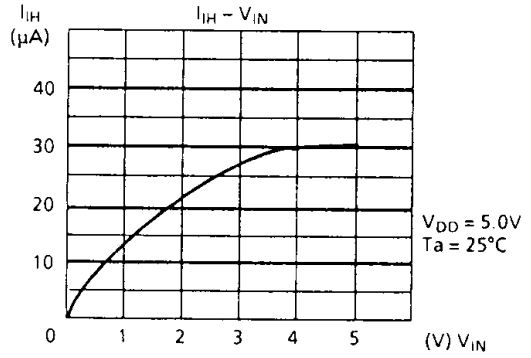
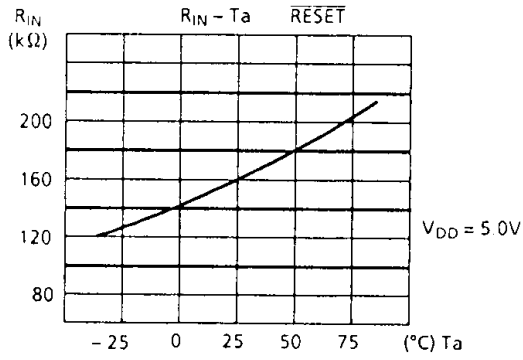

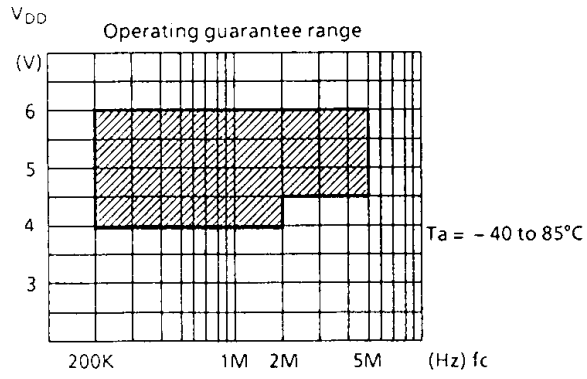
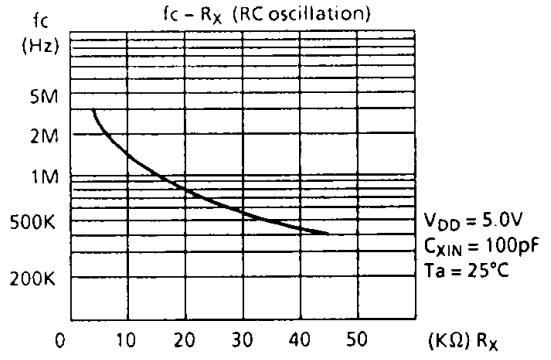
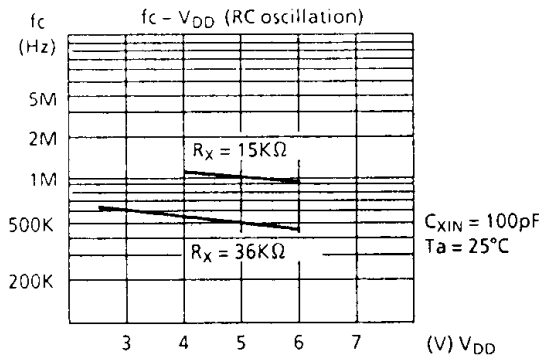

INPUT/OUTPUT CIRCUITRY

(1) Control pins

The input/output circuitries of the 42C50/70 control pins are shown below.

Oscillation type can be chosen by mask option either a ceramic resonator (external clock input) or an RC oscillator.

CONTROL PIN	I/O	CIRCUITRY	REMARKS
XIN XOUT	INPUT	<p>Option : Ceramic resonator or External clock input</p>	<p>Resonator connecting pins</p> <p>$R = 1K\Omega$ (typ.) $R_f = 1M\Omega$ (typ.)</p>
	OUTPUT	<p>Option : RC oscillation</p>	<p>Resonator connecting pins</p> <p>Hysteresis input</p> <p>$R = 1K\Omega$ (typ.) $R_f = 1M\Omega$ (typ.)</p>
RESET	INPUT		<p>Hysteresis input</p> <p>Pull-up resistor</p> <p>$R_{IN} = 160K\Omega$ (typ.) $R = 1K\Omega$ (typ.)</p>

(2) I/O ports

The input/output circuitries of 42C50/70 I/O ports are shown as below, any one of the circuitries can be chosen by a code (A, B, C, D) as a mask option.

Input/Output circuitry (Code : A)		Standard circuitry		
PORT	I/O	CIRCUITRY	initial state	REMARKS
P0 P1 P2	I/O		Input	Programmable I/O port Input mode : Input with pull-down Output mode : Push-pull R = 1KΩ (typ.)
P3 P4 P5	Output		High	Push-pull output

input/Output circuitry (Code : B)		Port P3 of the standard circuitry is changed to a sink open drain output and input.		
PORT	I/O	CIRCUITRY	Initial state	REMARKS
P0 P1 P2	I/O		Input	Programmable I/O port Input mode : Input with pull-down Output mode : Push-pull R = 1KΩ (typ.)
P3	I/O		Hi-Z (Input)	Sink open drain output (R = 1KΩ typ.)
P4 P5	Output		High	Push-pull output

Input/Output circuitry (Code : C) Ports P3 and P4 of the standard circuitry are changed to sink open drain outputs and inputs.

PORT	I/O	CIRCUITRY	Initial state	REMARKS
P0 P1 P2	I/O		input	Programmable I/O port Input mode : Input with pull-down Output mode : Push-pull output R = 1KΩ (typ.)
P3 P4	I/O		Hi-Z (Input)	Sink open drain output R = 1KΩ (typ.)
P5	Output		High	Push-pull output

Input/Output circuitry (Code : D) Ports P3 and P4 of the standard circuitry are changed to inputs with pull-up resistor.

PORT	I/O	CIRCUITRY	Initial state	REMARKS
P0 P1 P2	I/O		Input	Programmable I/O port Input mode : Input with pull-down Output mode : Push-pull R = 1KΩ (typ.)
P3 P4	Input		Input	Pull-up resistor R _{IN} = 90KΩ (typ.) R = 1KΩ (typ.)
P5	Output		High	Push-pull