

N-channel MOSFET

Features

- Low gate charge
- 100% avalanche tested
- Improved dv/dt capability
- RoHS compliant
- Halogen free package
- JEDEC Qualification

BV_{DSS}	I_D	$R_{DS(on)}$
650V	4A	<2.4 Ω

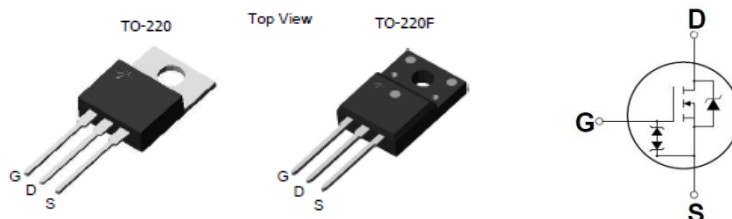

Device	Package	Marking	Remark
TMP4N65Z / TMPF4N65Z	TO-220 / TO-220F	TMP4N65Z / TMPF4N65Z	RoHS
TMP4N65ZG / TMPF4N65ZG	TO-220 / TO-220F	TMP4N65ZG / TMPF4N65ZG	Halogen Free

Absolute Maximum Ratings

Parameter	Symbol	TMP4N65Z(G)	TMPF4N65Z(G)	Unit	
Drain-Source Voltage	V_{DSS}	650		V	
Gate-Source Voltage	V_{GS}	± 30		V	
Continuous Drain Current	I_D	$T_C = 25\text{ }^\circ\text{C}$	4	4 *	A
		$T_C = 100\text{ }^\circ\text{C}$	2.4	2.4 *	A
Pulsed Drain Current (Note 1)	I_{DM}	16	16 *	A	
Single Pulse Avalanche Energy (Note 2)	E_{AS}	242		mJ	
Repetitive Avalanche Current (Note 1)	I_{AR}	4		A	
Repetitive Avalanche Energy (Note 1)	E_{AR}	9.84		mJ	
Power Dissipation	P_D	$T_C = 25\text{ }^\circ\text{C}$	98.4	32.9	W
		Derate above 25 $^\circ\text{C}$	0.78	0.26	W/ $^\circ\text{C}$
Peak Diode Recovery dv/dt (Note 3)	dv/dt	4.5		V/ns	
Operating Junction and Storage Temperature Range	T_J, T_{STG}	-55~150		$^\circ\text{C}$	
Maximum lead temperature for soldering purposes, 1/8" from case for 5 seconds	T_L	300		$^\circ\text{C}$	

* Limited only by maximum junction temperature

Thermal Characteristics

Parameter	Symbol	TMP4N65Z(G)	TMPF4N65Z(G)	Unit
Maximum Thermal resistance, Junction-to-Case	$R_{\theta JC}$	1.27	3.8	$^\circ\text{C}/\text{W}$
Maximum Thermal resistance, Junction-to-Ambient	$R_{\theta JA}$	62.5	62.5	$^\circ\text{C}/\text{W}$

Electrical Characteristics : $T_C=25^\circ\text{C}$, unless otherwise noted

Parameter	Symbol	Test condition	Min	Typ	Max	Units
OFF						
Drain-Source Breakdown Voltage	BV_{DSS}	$V_{GS} = 0\text{ V}, I_D = 250\ \mu\text{A}$	650	--	--	V
Zero Gate Voltage Drain Current	I_{DSS}	$V_{DS} = 650\text{ V}, V_{GS} = 0\text{ V}$	--	--	1	μA
		$V_{DS} = 520\text{ V}, T_C = 125^\circ\text{C}$	--	--	10	μA
Forward Gate-Source Leakage Current	I_{GSSF}	$V_{GS} = 30\text{ V}, V_{DS} = 0\text{ V}$	--	--	100	μA
Reverse Gate-Source Leakage Current	I_{GSSR}	$V_{GS} = -30\text{ V}, V_{DS} = 0\text{ V}$	--	--	-100	μA

ON

Gate Threshold Voltage	$V_{GS(th)}$	$V_{DS} = V_{GS}, I_D = 250\ \mu\text{A}$	2	--	4	V
Drain-Source On-Resistance	$R_{DS(on)}$	$V_{GS} = 10\text{ V}, I_D = 2.0\text{ A}$	--	2.0	2.4	Ω
Forward Transconductance ^(Note 4)	g_{FS}	$V_{DS} = 30\text{ V}, I_D = 2.0\text{ A}$	--	6.2	--	S

DYNAMIC

Input Capacitance	C_{iss}	$V_{DS} = 25\text{ V}, V_{GS} = 0\text{ V},$ $f = 1.0\text{ MHz}$	--	745	--	pF
Output Capacitance	C_{oss}		--	67	--	pF
Reverse Transfer Capacitance	C_{rss}		--	8.9	--	pF

SWITCHING

Turn-On Delay Time ^(Note 4,5)	$t_{d(on)}$	$V_{DD} = 325\text{ V}, I_D = 4.0\text{ A},$ $R_G = 25\ \Omega$	--	14	--	ns
Turn-On Rise Time ^(Note 4,5)	t_r		--	22	--	ns
Turn-Off Delay Time ^(Note 4,5)	$t_{d(off)}$		--	72	--	ns
Turn-Off Fall Time ^(Note 4,5)	t_f		--	19	--	ns
Total Gate Charge ^(Note 4,5)	Q_g	$V_{DS} = 520\text{ V}, I_D = 4.0\text{ A},$ $V_{GS} = 10\text{ V}$	--	16	--	nC
Gate-Source Charge ^(Note 4,5)	Q_{gs}		--	2.5	--	nC
Gate-Drain Charge ^(Note 4,5)	Q_{gd}		--	6	--	nC

SOURCE DRAIN DIODE

Maximum Continuous Drain-Source Diode Forward Current	I_S	----	--	--	4	A
Maximum Pulsed Drain-Source Diode Forward Current	I_{SM}	----	--	--	16	A
Drain-Source Diode Forward Voltage	V_{SD}	$V_{GS} = 0\text{ V}, I_S = 4.0\text{ A}$	--	--	1.5	V
Reverse Recovery Time ^(Note 4)	t_{rr}	$V_{GS} = 0\text{ V}, I_S = 4.0\text{ A}$ $di_F / dt = 100\text{ A}/\mu\text{s}$	--	326	--	ns
Reverse Recovery Charge ^(Note 4)	Q_{rr}		--	1.8	--	μC

Note :

1. Repeated rating : Pulse width limited by safe operating area
2. $L=28\text{mH}, I_{AS} = 4\text{ A}, V_{DD} = 50\text{ V}, R_G = 25\ \Omega,$ Starting $T_J = 25^\circ\text{C}$
3. $I_{SD} \leq 4\text{ A}, di/dt \leq 200\text{ A}/\mu\text{s}, V_{DD} \leq BV_{DS},$ Starting $T_J = 25^\circ\text{C}$
4. Pulse Test : Pulse width $\leq 300\ \mu\text{s},$ Duty Cycle $\leq 2\%$
5. Essentially Independent of Operating Temperature Typical Characteristics

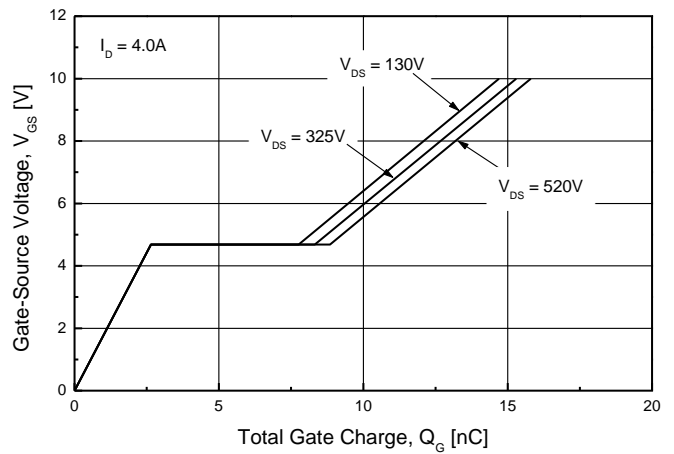
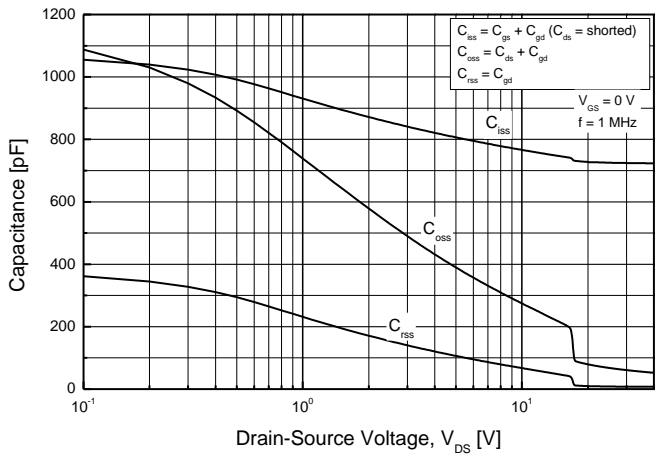
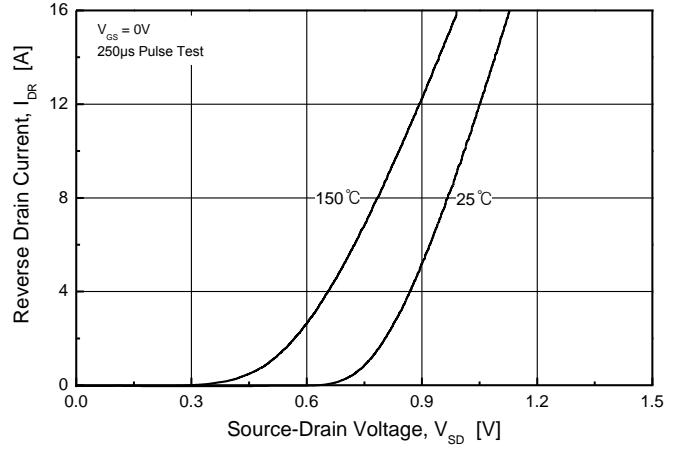
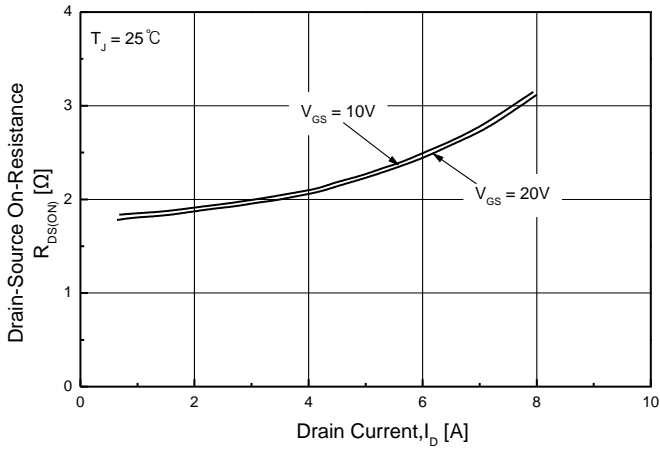
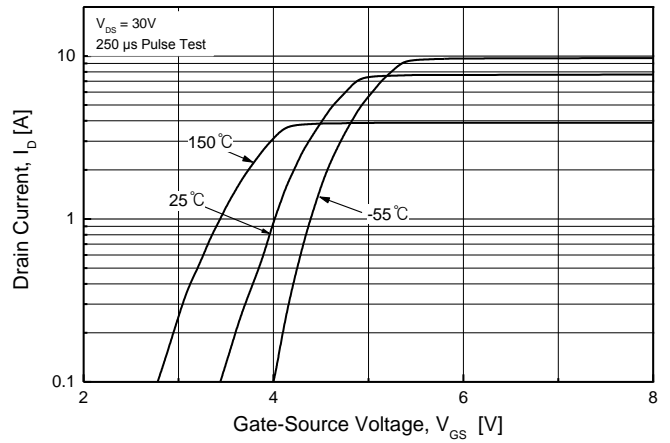
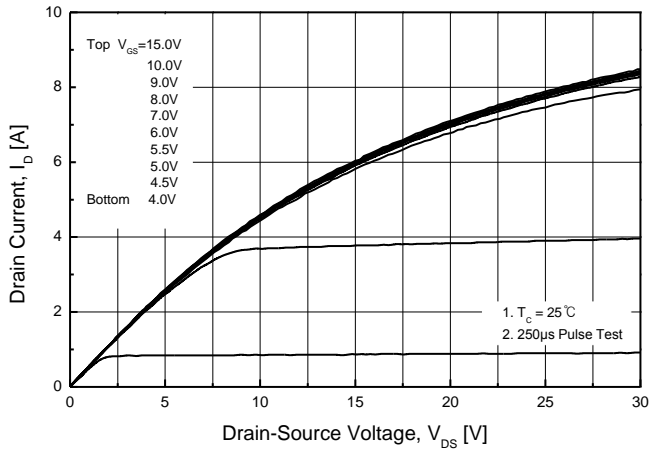

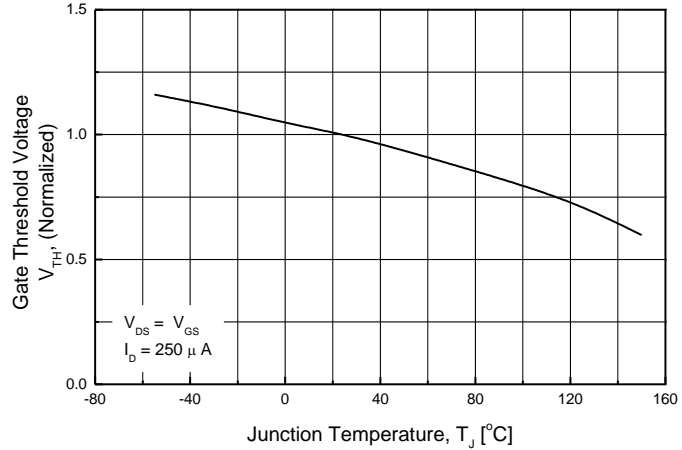
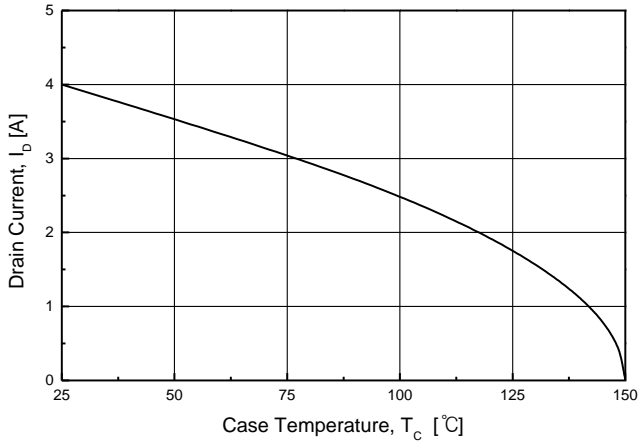
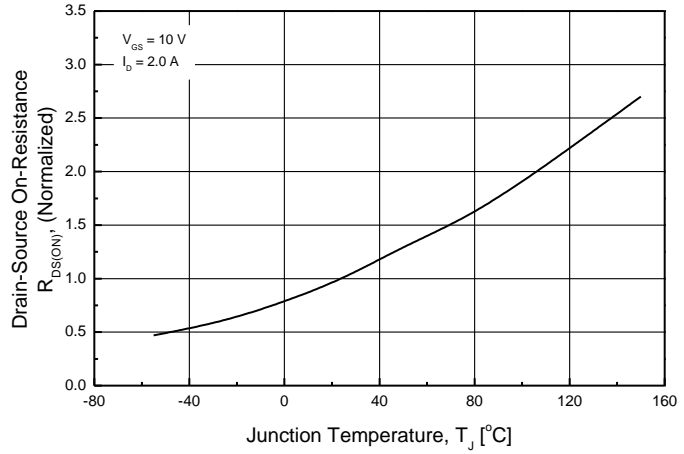
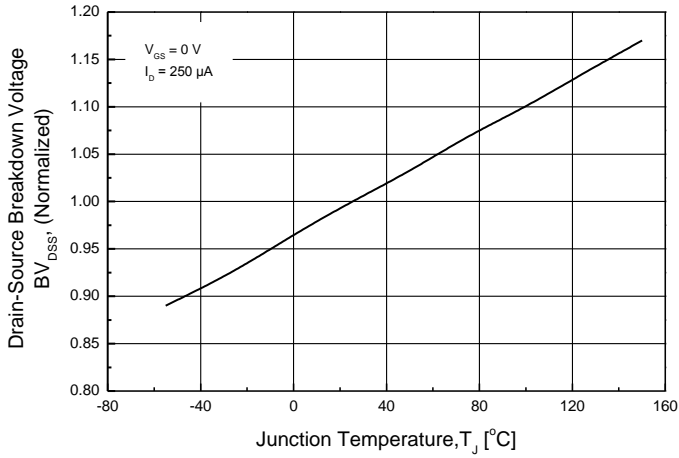

TMP4N65Z(G)

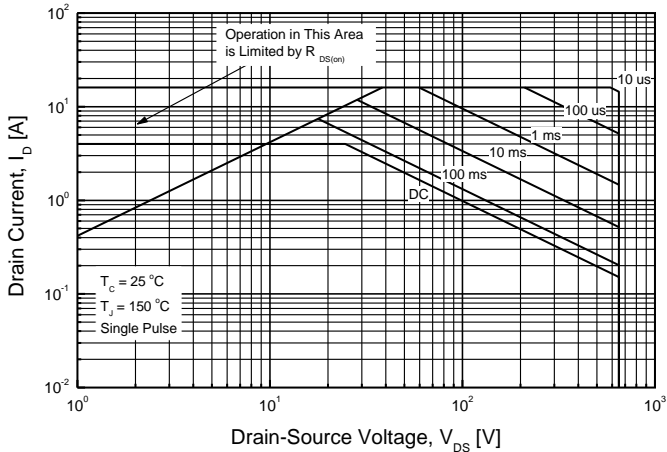

TMPF4N65Z(G)

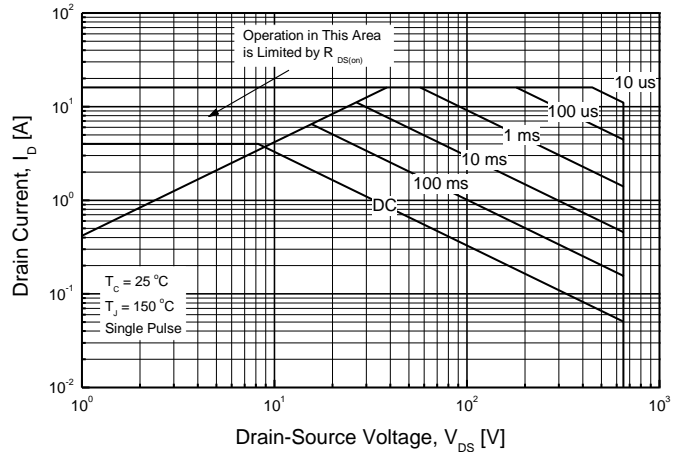

TMP4N65Z(G)

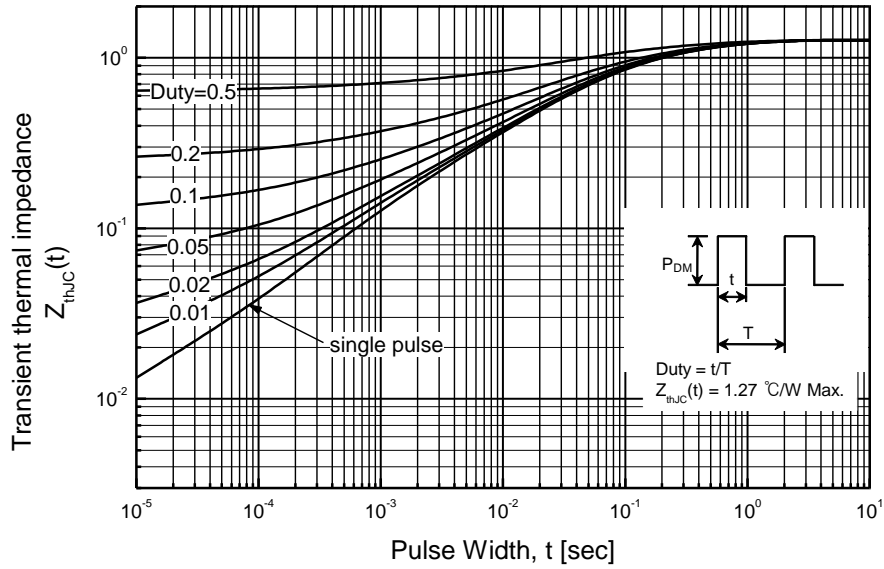

TMPF4N65Z(G)

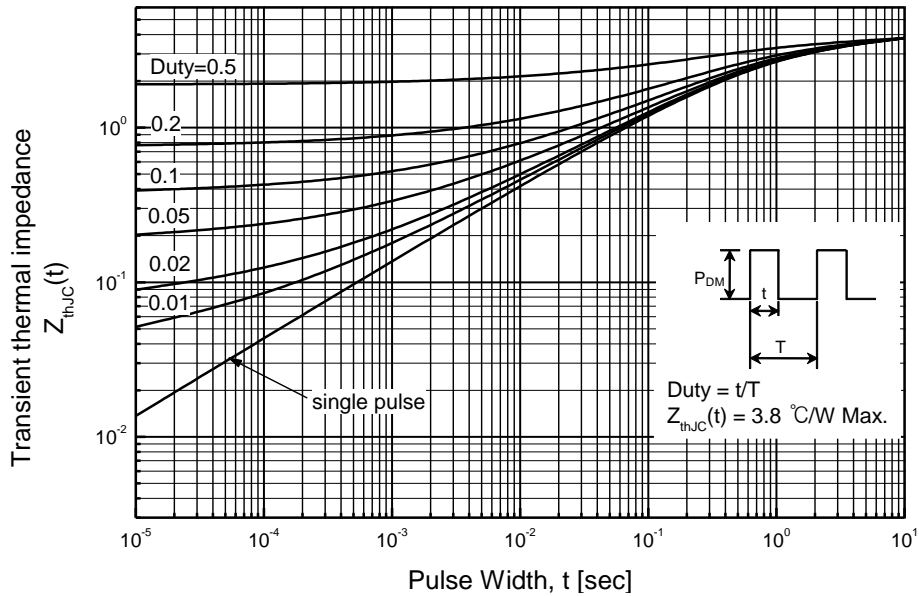

TO-220AB-3L MECHANICAL DATA

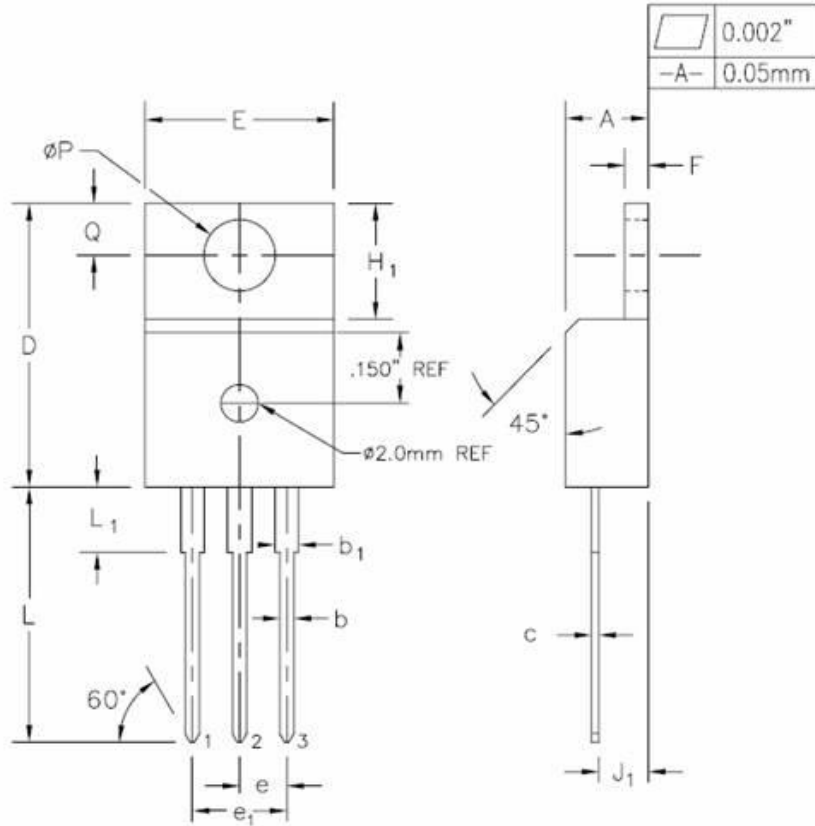

SYMBOL	INCHES		MILLIMETERS		NOTES
	MIN.	MAX.	MIN.	MAX.	
A	0.170	0.180	4.32	4.57	
b	0.028	0.036	0.71	0.91	
b ₁	0.045	0.055	1.15	1.39	
c	0.014	0.021	0.36	0.53	
D	0.590	0.610	14.99	15.49	
E	0.395	0.410	10.04	10.41	
e	0.100 TYP.		2.54 TYP.		
e ₁	0.200 BSC		5.08 BSC		
F	0.048	0.054	1.22	1.37	
H ₁	0.235	0.255	5.97	6.47	
J ₁	0.100	0.110	2.54	2.79	
L	0.530	0.550	13.47	13.97	
L ₁	0.130	0.150	3.31	3.81	2
∅P	0.149	0.153	3.79	3.88	
Q	0.102	0.112	2.60	2.84	

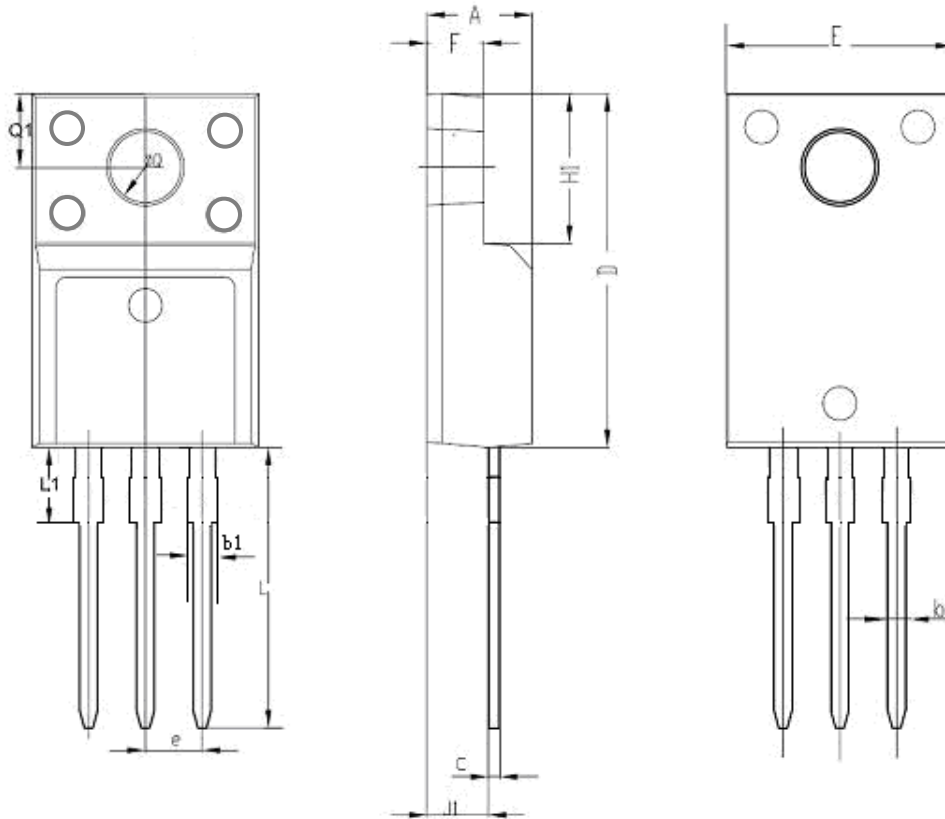
TO-220F-3L MECHANICAL DATA

SYMBOL	INCHES		MILLIMETERS		NOTES
	MIN	MAX	MIN	MAX	
A	0.178	0.194	4.53	4.93	
b	0.028	0.036	0.71	0.91	
C	0.018	0.024	0.45	0.60	
D	0.617	0.633	15.67	16.07	
E	0.392	0.408	9.96	10.36	
e	0.100 TYP.		2.54TYP.		
H1	0.256	0.272	6.50	6.90	
J1	0.101	0.117	2.56	2.96	
L	0.503	0.519	12.78	13.18	
φQ	0.117	0.133	2.98	3.38	
b1	0.045	0.055	1.15	1.39	
L1	0.114	0.130	2.9	3.3	
Q1	0.122	0.138	3.10	3.50	
F	0.092	0.108	2.34	2.74	