

### Features

- Low gate charge
- 100% avalanche tested
- Improved dv/dt capability
- RoHS compliant
- Halogen free package
- JEDEC Qualification

$$V_{DSS} = 880 \text{ V @ } T_{jmax}$$

$$I_D = 4 \text{ A}$$

$$R_{DS(ON)} = 3.0 \Omega(\text{max}) @ V_{GS} = 10 \text{ V}$$

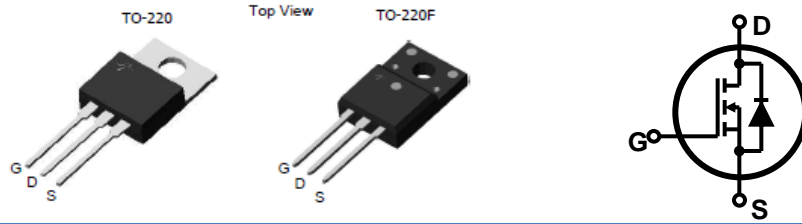

Device	Package	Marking	Remark
TMP4N80	TO-220	TMP4N80	RoHS
TMPF4N80G	TO-220F	TMPF4N80G	Halogen Free

### Absolute Maximum Ratings

Parameter	Symbol	TMP4N80(G)	TMPF4N80(G)	Unit	
Drain-Source Voltage	$V_{DSS}$	800		V	
Gate-Source Voltage	$V_{GS}$	±30		V	
Continuous Drain Current	$I_D$	$T_C = 25 \text{ }^\circ\text{C}$	4	4*	A
		$T_C = 100 \text{ }^\circ\text{C}$	2.5	2.5 *	A
Pulsed Drain Current (Note 1)	$I_{DM}$	16	16*	A	
Single Pulse Avalanche Energy (Note 2)	$E_{AS}$	76		mJ	
Repetitive Avalanche Current (Note 1)	$I_{AR}$	4		A	
Repetitive Avalanche Energy (Note 1)	$E_{AR}$	12.3		mJ	
Power Dissipation	$P_D$	$T_C = 25 \text{ }^\circ\text{C}$	123	38.6	W
		Derate above 25 °C	0.98	0.31	W/°C
Peak Diode Recovery dv/dt (Note 3)	dv/dt	4.5		V/ns	
Operating Junction and Storage Temperature Range	$T_J, T_{STG}$	-55~150		°C	
Maximum lead temperature for soldering purposes, 1/8" from case for 5 seconds	$T_L$	300		°C	

\* Limited only by maximum junction temperature

### Thermal Characteristics

Parameter	Symbol	TMP4N80(G)	TMPF4N80(G)	Unit
Maximum Thermal resistance, Junction-to-Case	$R_{\theta JC}$	1.01	3.23	°C/W
Maximum Thermal resistance, Junction-to-Ambient	$R_{\theta JA}$	62.5	62.5	°C/W

**Electrical Characteristics :  $T_C=25^\circ\text{C}$ , unless otherwise noted**

Parameter	Symbol	Test condition	Min	Typ	Max	Units
<b>OFF</b>						
Drain-Source Breakdown Voltage	$BV_{DSS}$	$V_{GS} = 0\text{ V}, I_D = 250\ \mu\text{A}$	800	--	--	V
Zero Gate Voltage Drain Current	$I_{DSS}$	$V_{DS} = 800\text{ V}, V_{GS} = 0\text{ V}$	--	--	10	$\mu\text{A}$
		$V_{DS} = 640\text{ V}, T_C = 125^\circ\text{C}$	--	--	100	$\mu\text{A}$
Forward Gate-Source Leakage Current	$I_{GSSF}$	$V_{GS} = 30\text{ V}, V_{DS} = 0\text{ V}$	--	--	100	nA
Reverse Gate-Source Leakage Current	$I_{GSSR}$	$V_{GS} = -30\text{ V}, V_{DS} = 0\text{ V}$	--	--	-100	nA

**ON**

Gate Threshold Voltage	$V_{GS(th)}$	$V_{DS} = V_{GS}, I_D = 250\ \mu\text{A}$	2	--	4	V
Drain-Source On-Resistance	$R_{DS(on)}$	$V_{GS} = 10\text{ V}, I_D = 2\text{ A}$	--	2.5	3.0	$\Omega$
Forward Transconductance <sup>(Note 4)</sup>	$g_{FS}$	$V_{DS} = 30\text{ V}, I_D = 2\text{ A}$	--	3.7	--	S

**DYNAMIC**

Input Capacitance	$C_{iss}$	$V_{DS} = 25\text{ V}, V_{GS} = 0\text{ V},$ $f = 1.0\text{ MHz}$	--	1020	--	pF
Output Capacitance	$C_{oss}$		--	77	--	pF
Reverse Transfer Capacitance	$C_{rss}$		--	10.3	--	pF

**SWITCHING**

Turn-On Delay Time <sup>(Note 4,5)</sup>	$t_{d(on)}$	$V_{DD} = 400\text{ V}, I_D = 4\text{ A},$ $R_G = 25\ \Omega$	--	22	--	ns
Turn-On Rise Time <sup>(Note 4,5)</sup>	$t_r$		--	25	--	ns
Turn-Off Delay Time <sup>(Note 4,5)</sup>	$t_{d(off)}$		--	84	--	ns
Turn-Off Fall Time <sup>(Note 4,5)</sup>	$t_f$		--	27	--	ns
Total Gate Charge <sup>(Note 4,5)</sup>	$Q_g$	$V_{DS} = 640\text{ V}, I_D = 4\text{ A},$ $V_{GS} = 10\text{ V}$	--	21	--	nC
Gate-Source Charge <sup>(Note 4,5)</sup>	$Q_{gs}$		--	3.2	--	nC
Gate-Drain Charge <sup>(Note 4,5)</sup>	$Q_{gd}$		--	7.8	--	nC

**SOURCE DRAIN DIODE**

Maximum Continuous Drain-Source Diode Forward Current	$I_S$	---	--	--	4	A
Maximum Pulsed Drain-Source Diode Forward Current	$I_{SM}$	---	--	--	16	A
Drain-Source Diode Forward Voltage	$V_{SD}$	$V_{GS} = 0\text{ V}, I_S = 4\text{ A}$	--	--	1.5	V
Reverse Recovery Time <sup>(Note 4)</sup>	$t_{rr}$	$V_{GS} = 0\text{ V}, I_S = 4\text{ A}$	--	404	--	ns
Reverse Recovery Charge <sup>(Note 4)</sup>	$Q_{rr}$	$di_F / dt = 100\text{ A}/\mu\text{s}$	--	2.8	--	$\mu\text{C}$

Note :

1. Repeated rating : Pulse width limited by safe operating area
2.  $L = 8.9\text{ mH}, I_{AS} = 4\text{ A}, V_{DD} = 50\text{ V}, R_G = 25\ \Omega,$  Starting  $T_J = 25^\circ\text{C}$
3.  $I_{SD} \leq 4\text{ A}, di/dt \leq 200\text{ A}/\mu\text{s}, V_{DD} \leq BV_{DS},$  Starting  $T_J = 25^\circ\text{C}$
4. Pulse Test : Pulse width  $\leq 300\ \mu\text{s},$  Duty Cycle  $\leq 2\%$
5. Essentially Independent of Operating Temperature Typical Characteristics

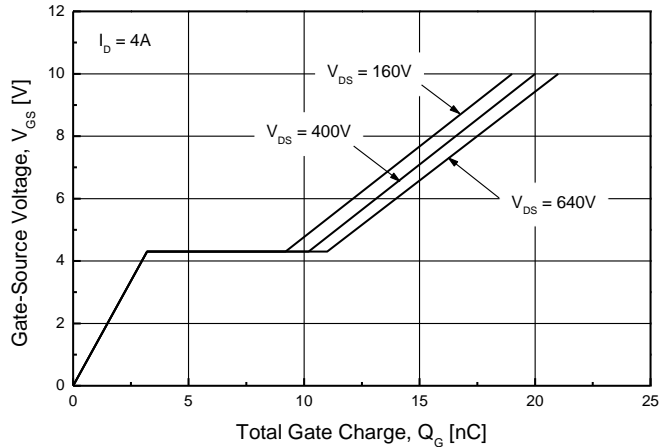
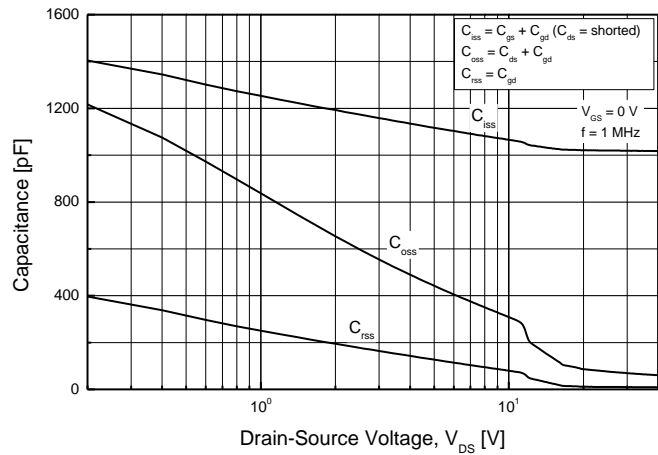
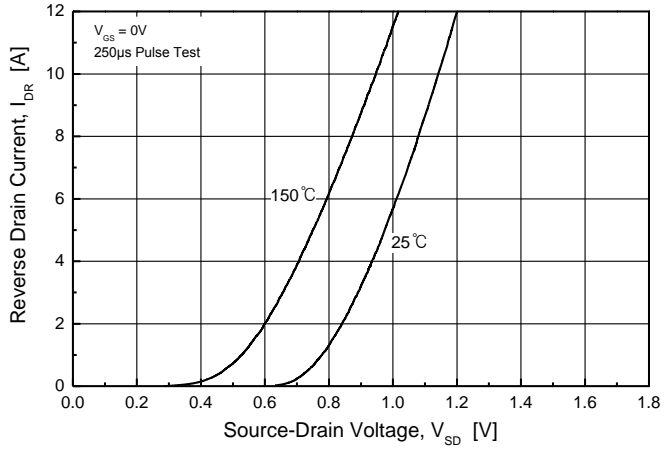
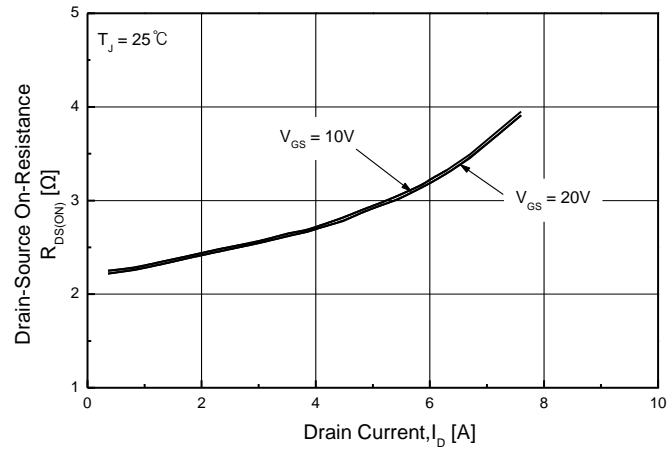
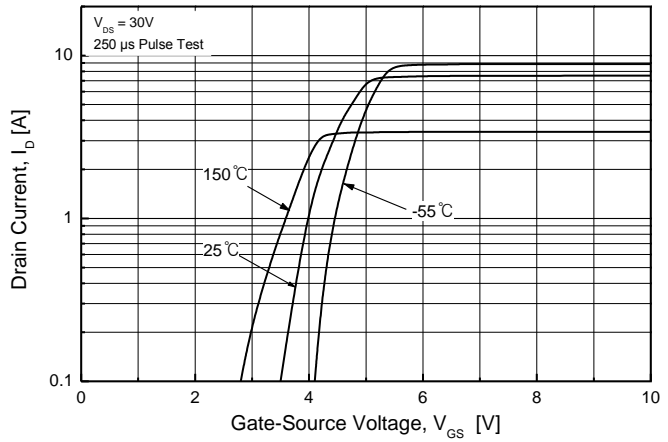
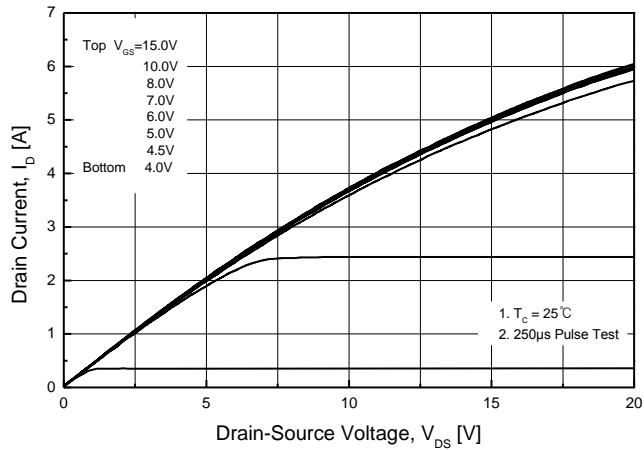

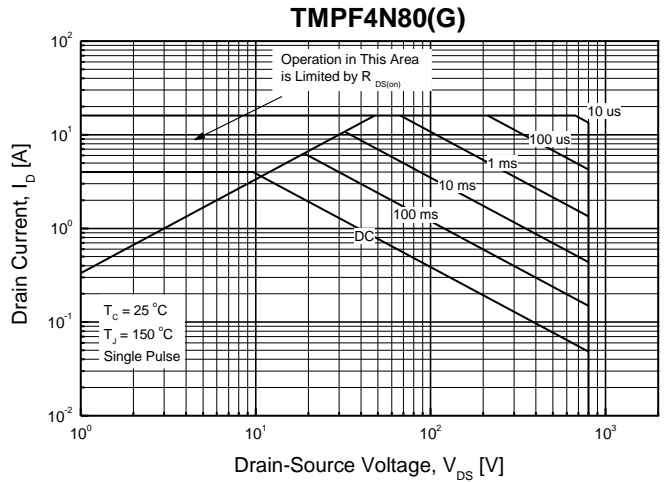
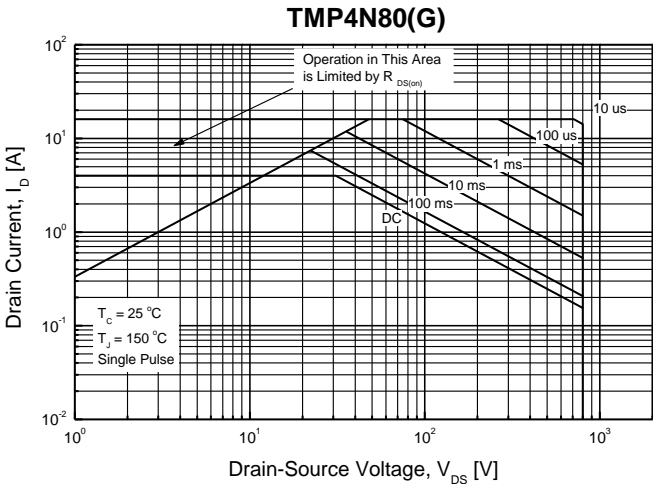
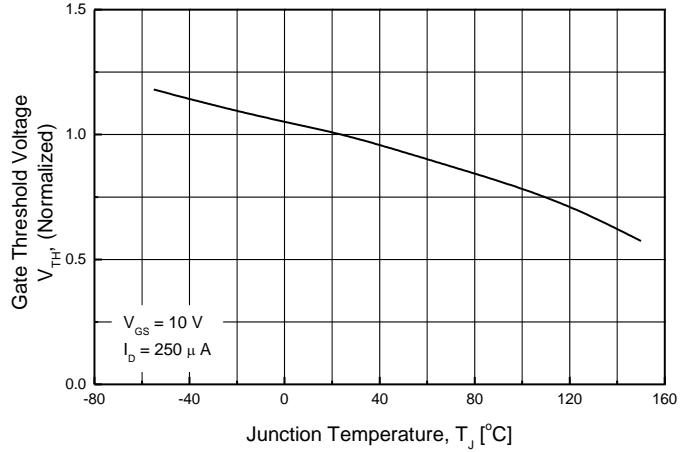
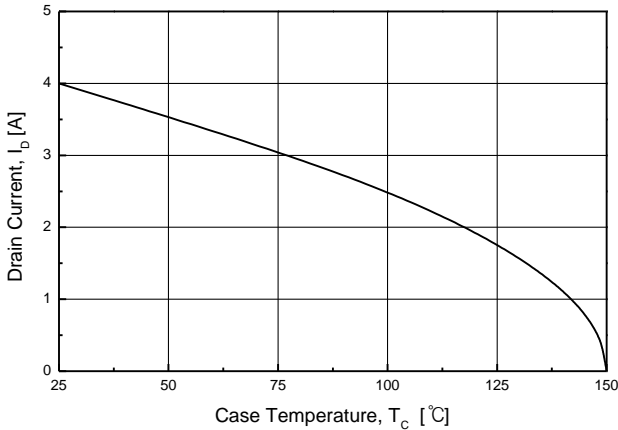
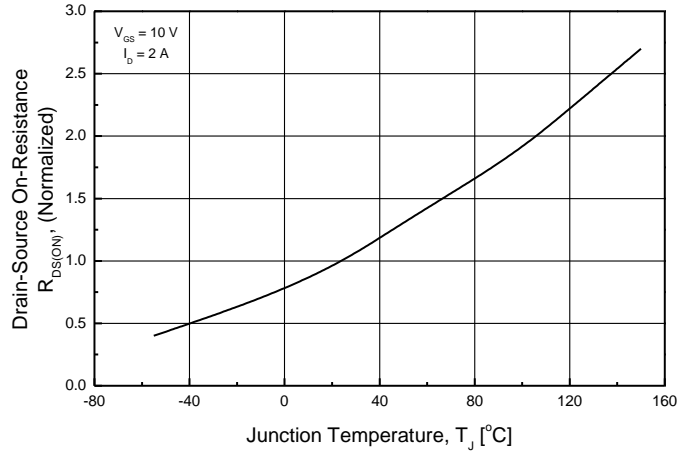
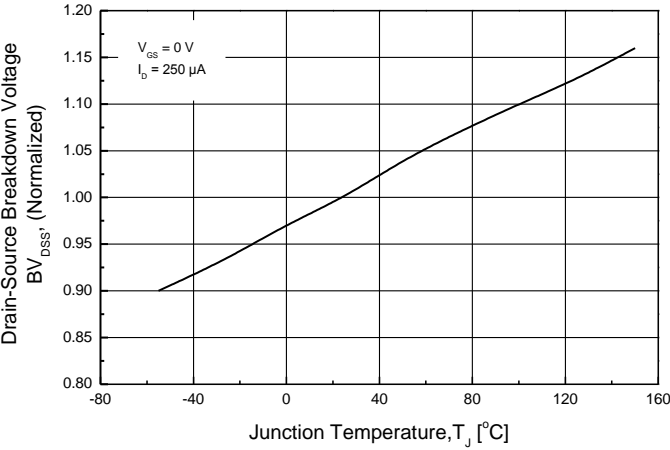

**TMP4N80(G)**

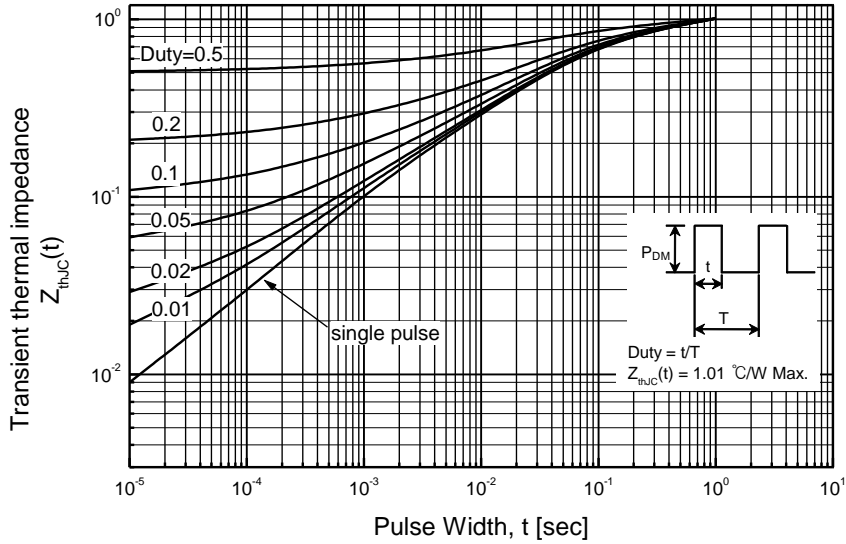

**TMPF4N80(G)**

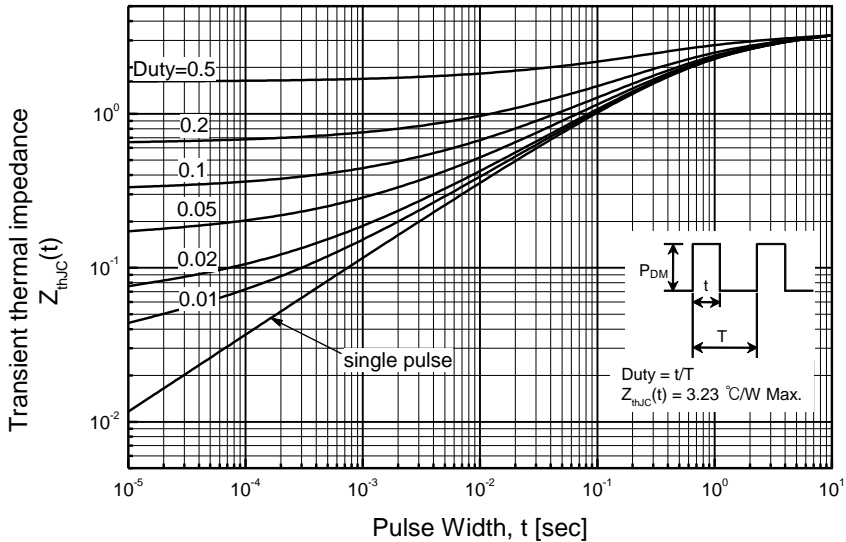

TO-220AB-3L MECHANICAL DATA

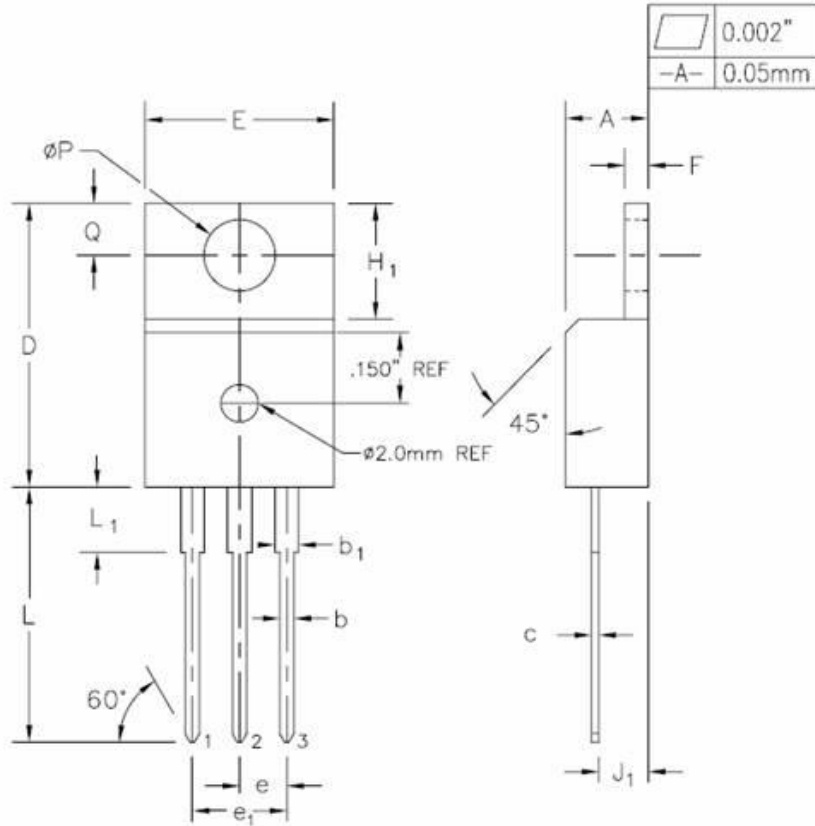

SYMBOL	INCHES		MILLIMETERS		NOTES
	MIN.	MAX.	MIN.	MAX.	
A	0.170	0.180	4.32	4.57	
b	0.028	0.036	0.71	0.91	
b <sub>1</sub>	0.045	0.055	1.15	1.39	
c	0.014	0.021	0.36	0.53	
D	0.590	0.610	14.99	15.49	
E	0.395	0.410	10.04	10.41	
e	0.100 TYP.		2.54 TYP.		
e <sub>1</sub>	0.200 BSC		5.08 BSC		
F	0.048	0.054	1.22	1.37	
H <sub>1</sub>	0.235	0.255	5.97	6.47	
J <sub>1</sub>	0.100	0.110	2.54	2.79	
L	0.530	0.550	13.47	13.97	
L <sub>1</sub>	0.130	0.150	3.31	3.81	2
∅P	0.149	0.153	3.79	3.88	
Q	0.102	0.112	2.60	2.84	

TO-220F-3L MECHANICAL DATA

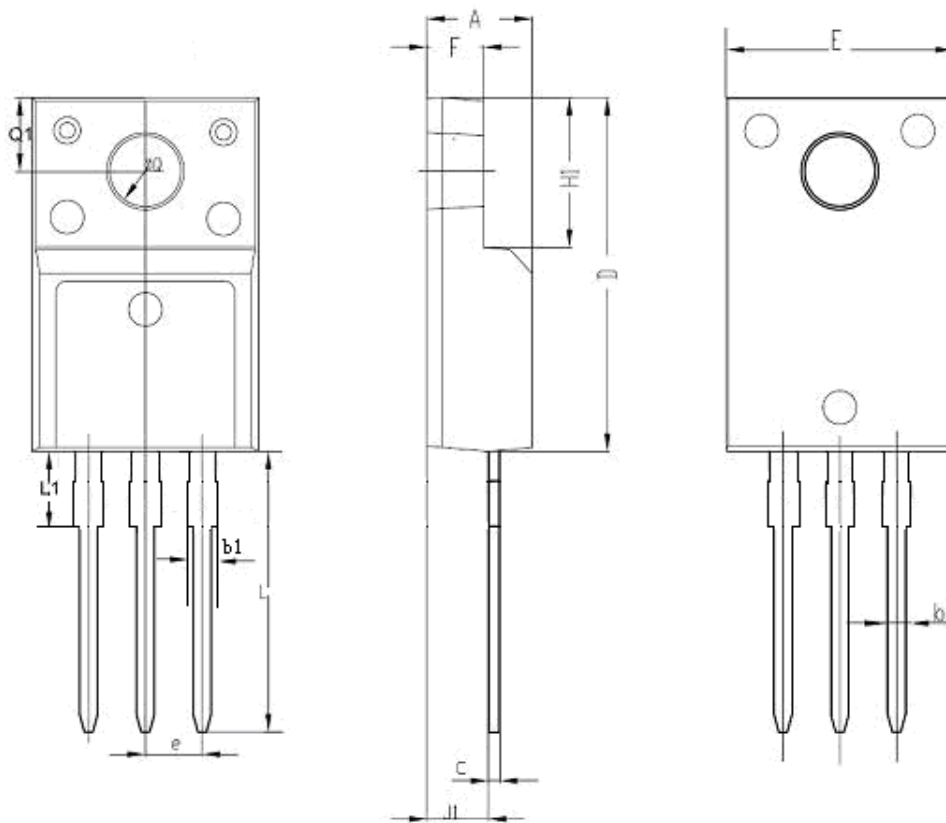

SYMBOL	INCHES		MILLIMETERS		NOTES
	MIN	MAX	MIN	MAX	
A	0.178	0.194	4.53	4.93	
b	0.028	0.036	0.71	0.91	
C	0.018	0.024	0.45	0.60	
D	0.617	0.633	15.67	16.07	
E	0.392	0.408	9.96	10.36	
e	0.100 TYP.		2.54TYP.		
H1	0.256	0.272	6.50	6.90	
J1	0.101	0.117	2.56	2.96	
L	0.503	0.519	12.78	13.18	
φQ	0.117	0.133	2.98	3.38	
b1	0.045	0.055	1.15	1.39	
L1	0.114	0.130	2.9	3.3	
Q1	0.122	0.138	3.10	3.50	
F	0.092	0.108	2.34	2.74	