

CMOS 8-BIT MICROCONTROLLER

TMP87PH40KF

The 87PH40K is a One-Time PROM microcontroller with low-power 128K bits (32K bytes) electrically programmable read only memory for the 87CH40K system evaluation. The 87PH40K is pin compatible with the 87CH40K. The operations possible with the 87CH40K can be performed by writing programs to PROM. The 87PH40K can write and verify in the same way as the TMM27256AD using an adaptor socket BM1137 and an EPROM programmer.

Notice on Handling

The 87PH40KF is still in the development process and should only be used for evaluating the operation of application equipments. (Only for Sample)

PART No.	OTP	RAM	PACKAGE
TMP87PH40KF	32K x 8-bit	512 x 8-bit	QFP64

PIN ASSIGNMENTS (TOP VIEW)

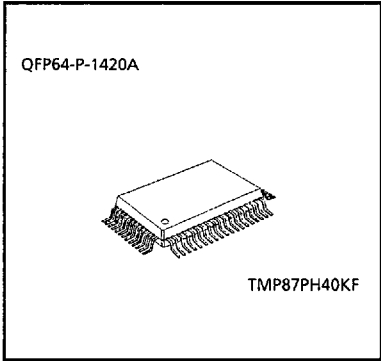
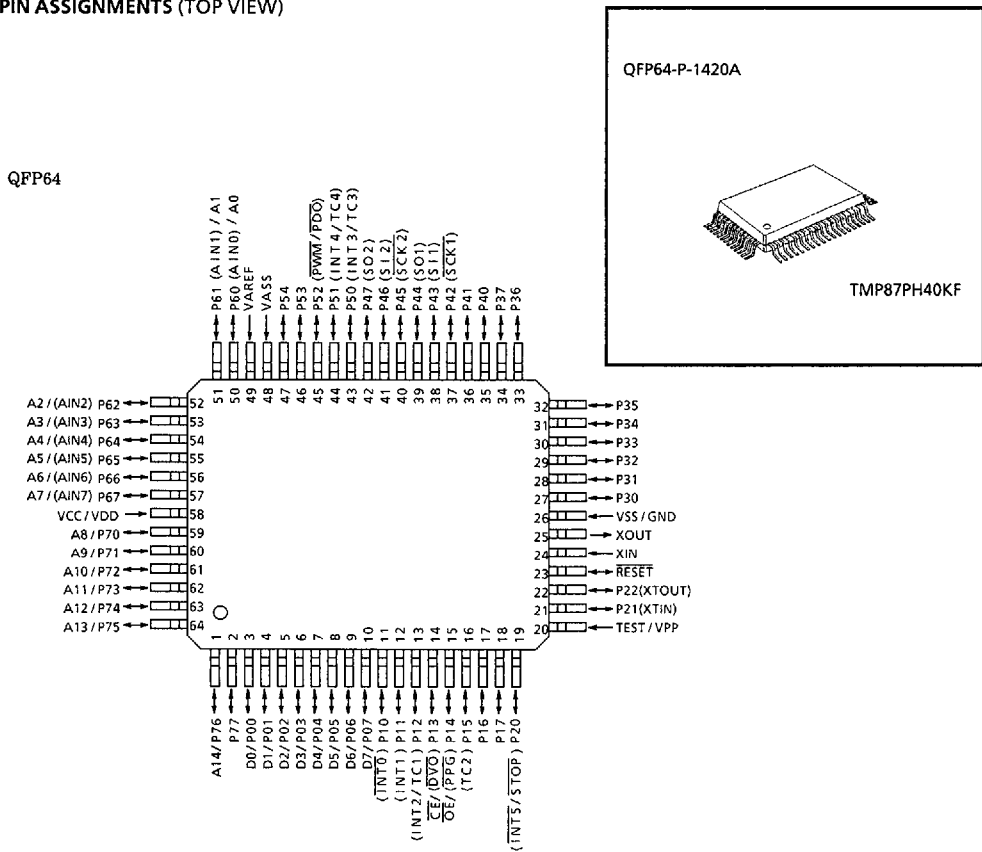

PIN FUNCTION

The 87PH40K has two modes: MCU and PROM.

(1) MCU mode

In this mode, the 87PH40K is pin compatible with the 87CH40K (fix the TEST pin at low level).

(2) PROM mode

PIN NAME (PROM mode)	INPUT/OUTPUT	FUNCTIONS	PIN NAME (MCU mode)	
A14 ~ A8 A7 ~ A0	Input	PROM address inputs	P76 ~ P70 P67 ~ P60	
D7 ~ D0	I/O	PROM data input/outputs	P07 ~ P00	
\overline{CE}	Input	Chip enable signal input (active low)	P13	
\overline{OE}		Output enable signal input (active low)	P14	
VPP	Power supply	+ 12.5V / 5V (Program supply voltage)	TEST	
VCC		+ 5V	VDD	
GND		0V	VSS	
P37 ~ P30 P47 ~ P40 P54 ~ P50	I/O	Pull-up with resistance for input processing		
P11				PROM mode setting pin. Be fixed at high level.
P21				
P77				
P17 ~ P15				
P12, P10 P22, P20		PROM mode setting pin. Be fixed at low level.		
RESET				
XIN		Input		Connect an 3.7MHz oscillator to stabilize the internal state.
XOUT	Output			
VAREF VASS	Power Supply	0V (GND)		

OPERATIONAL DESCRIPTION

The following explains the 87PH40K hardware configuration and operation. The configuration and functions of the 87PH40K are the same as those of the 87CH40K, except in that a one-time PROM is used instead of an on-chip mask ROM.

The 87PH40K is placed in the *single-clock* mode during reset. To use the dual-clock mode, the low-frequency oscillator should be turned on by executing [SET (SYSCR2). XTEN] instruction at the beginning of the program.

1. OPERATING MODE

The 87PH40K has two modes: MCU and PROM.

1.1 MCU mode

The MCU mode is activated by fixing the TEST / VPP pin at low level.

In the MCU mode, operation is the same as with the 87CH40K (the TEST / VPP pin cannot be used open because it has no built-in pull-down resistance).

1.1.1 Program Memory

The 87PH40K has a 16K × 8-bit (addresses C000_H-FFFF_H in the MCU mode, addresses 4000_H-7FFF_H in the PROM mode) of program memory (OTP).

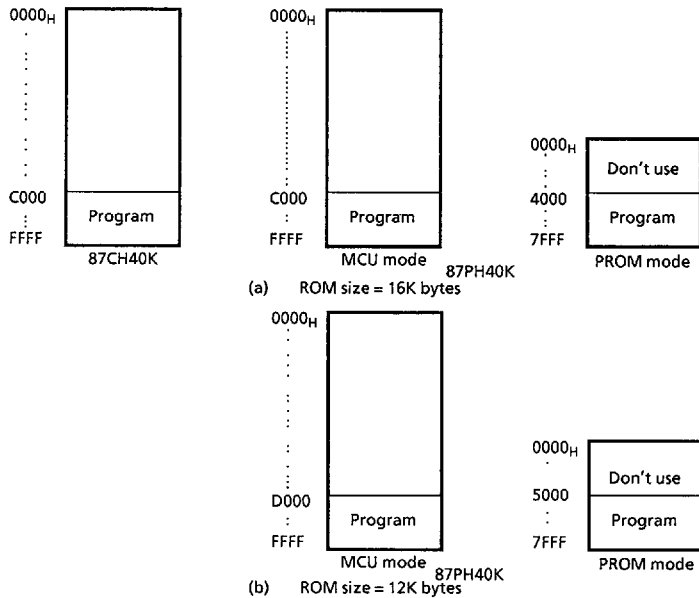

Figure 1-1. Program Memory Area

Either write the data FF_H to the unused area or set the PROM programmer to access only the program storage area.

1.1.2 Data Memory

The 87PH40K has an on-chip 512 × 8-bit data memory (static RAM).

1.1.3 Input/Output Circuitry

(1) Control pins

The control pins of the 87PH40K are the same as those of the 87CH40K except that the TEST pin has no built-in pull-down resistance.

(2) I/O ports

The I/O circuitries of 87PH40K I/O ports are the same as the code A type I/O circuitries of the 87CH40K.

When using as an evaluator of other I/O codes (B, C, G), external pull-up resistors are required.

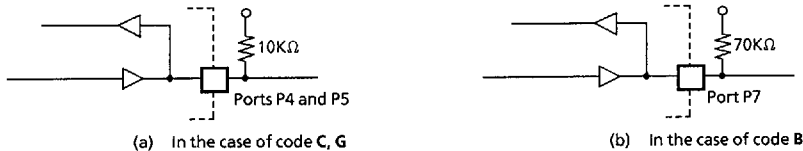

Figure 1-2. I/O Circuitry Code and External Circuitry

1.2 PROM mode

The PROM mode is activated by setting the TEST, $\overline{\text{RESET}}$ pin and the ports P17-P10, P22-P20 and P77 as shown in Figure 1-3. The PROM mode is used to write and verify programs with a general-purpose PROM programmer. The high-speed programming mode can be used for program operation.

The 87PH40K is not supported an *electric signature* mode, so the ROM type must be set to TMM27256 AD.

Set the adaptor socket switch to "P".

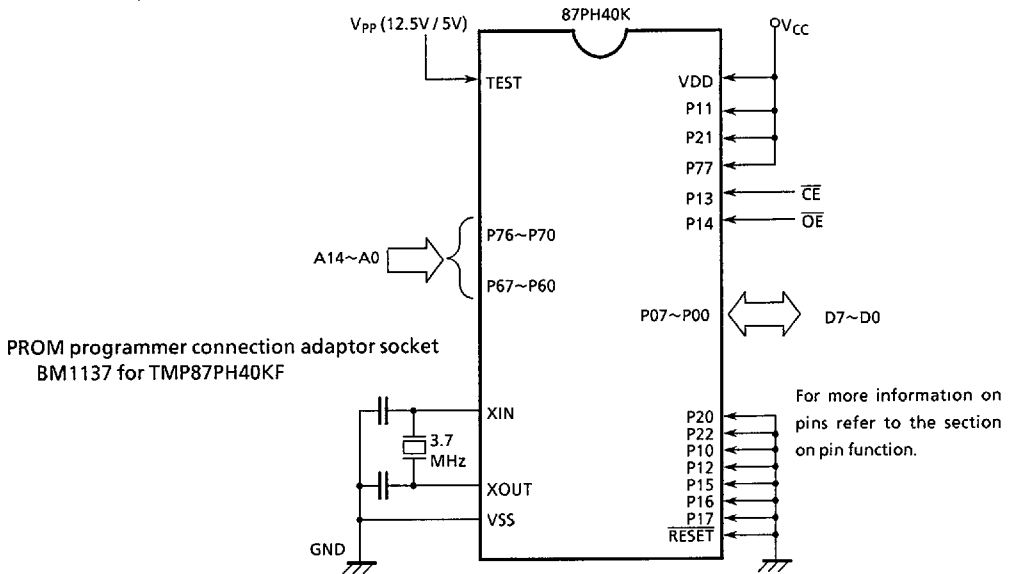

Figure 1-3. Setting for PROM Mode

1.2.1 Programming Flowchart (High-speed Programming Mode)

The high-speed programming mode is achieved by applying the program voltage (+ 12.5V) to the VPP pin when Vcc = 6V. After the address and input data are stable, the data is programmed by applying a single 1ms program pulse to the CE input. The programmed data is verified. If incorrect, another 1ms program pulse is applied and then the programmed data is verified. This process should be repeated (up to 25 times) until the program operates correctly. Programming for one address is ended by applying additional program pulse with width 3 times that needed for initial programming (number of programmed times × 1ms). After that, change the address and input data, and program as before. When programming has been completed, the data in all addresses should be verified with Vcc = Vpp = 5V.

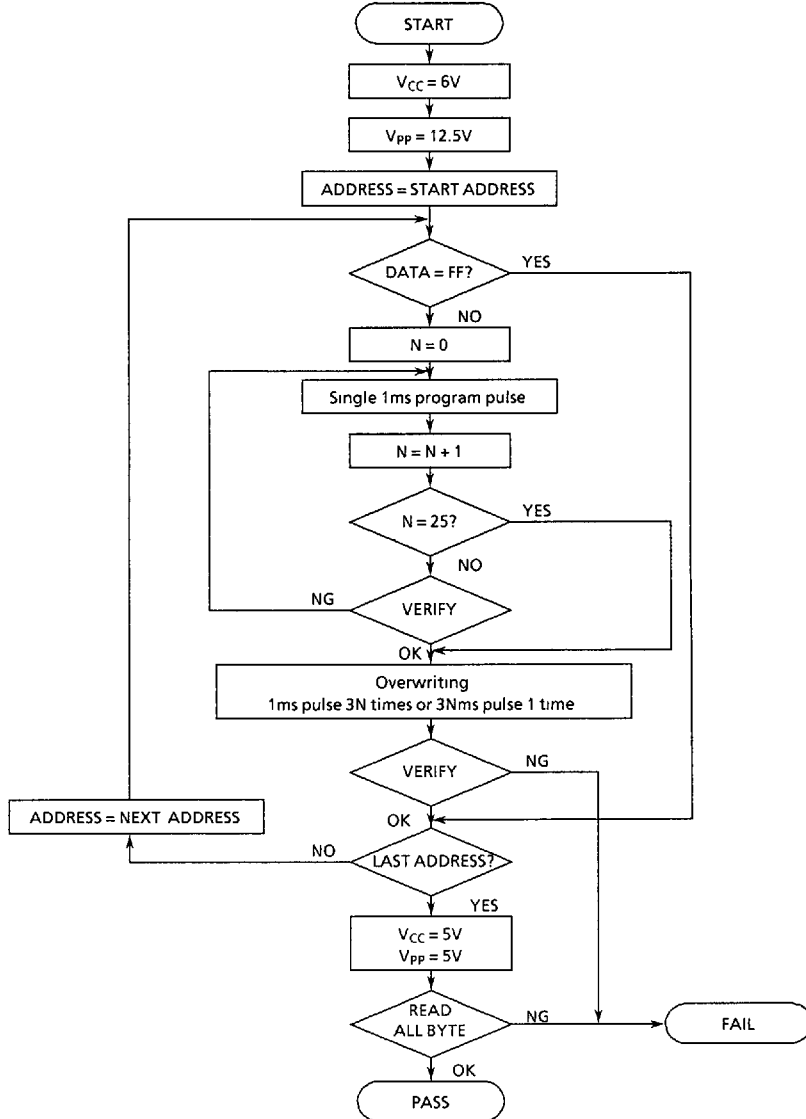

Figure 1-4. FLOW CHART OF HIGH-SPEED PROGRAMMING

ELECTRICAL CHARACTERISTICS

ABSOLUTE MAXIMUM RATINGS

(V_{SS} = 0V)

PARAMETER	SYMBOL	CONDITIONS	RATINGS	UNIT
Supply Voltage	V _{DD}		- 0.3 to 6	V
Program Voltage	V _{PP}		- 0.3 to 13.0	V
Input Voltage	V _{IN}		- 0.3 to V _{DD} + 0.3	V
Output Voltage	V _{OUT1}	Except sink open drain pin , but include P2 and RESET	- 0.3 to V _{DD} + 0.3	V
	V _{OUT2}	Sink open drain pin except port P2, RESET	- 0.3 to 10	
Output Current (Per 1 pin)	I _{OUT1}	Ports P0, P1, P2, P3, P4, P5, P6, P7	3.2	mA
	I _{OUT2}	Port P3	30	
Output Current (Total)	Σ I _{OUT1}	Ports P0, P1, P2, P4, P5, P6, P7	120	mA
	Σ I _{OUT2}	Port P3	120	
Power Dissipation [T _{opr} = 70°C]	PD		350	mW
Soldering Temperature (time)	T _{slid}		260 (10sec)	°C
Storage Temperature	T _{stg}		- 55 to 125	°C
Operating Temperature	T _{opr}		10 to 40	°C

RECOMMENDED OPERATING CONDITIONS

(V_{SS} = 0V, T_{opr} = 10 to 40°C)

PARAMETER	SYMBOL	PINS	CONDITIONS	Min.	Max.	UNIT	
Supply Voltage	V _{DD}		fc =	NORMAL1, 2 mode	2.0	4.0	V
			3.7MHz	IDLE1, 2 mode			
			fs =	SLOW mode			
			32.768kHz	SLEEP mode			
				STOP mode			
Input High Voltage	V _{IH}			V _{DD} × 0.90	V _{DD}	V	
Input Low Voltage	V _{IL}			0	V _{DD} × 0.10	V	
Clock Frequency	fc	XIN, XOUT		0.4	3.7	MHz	
	fs	XTIN, XTOUT		30.0	34.0	KHz	

D.C. CHARACTERISTICS

(V_{SS} = 0V, T_{opr} = 10 to 40°C)

PARAMETER	SYMBOL	PINS	CONDITIONS	Min.	Typ.	Max.	UNIT
Hysteresis Voltage	V _{H5}	Hysteresis inputs		-	0.9	-	V
Input Current	I _{IN1}	TEST	V _{DD} = 4.0V V _{IN} = 4.0V / 0V	-	-	± 2	μA
	I _{IN2}	Open drain ports and tri-state ports					
	I _{IN3}	RESET, STOP					
Input Low Current	I _{IL}	Push-pull ports	V _{DD} = 4.0V, V _{IN} = 0.1V	-	-	- 2	mA
Input Resistance	R _{IN1}	Port P7 with pull-up		30	70	150	KΩ
	R _{IN2}	RESET		100	220	450	
Output Leakage Current	I _{LO1}	Open drain ports	V _{DD} = 4.0V, V _{OUT} = 4.0V	-	-	2	μA
	I _{LO2}	Tri-state ports	V _{DD} = 4.0V, V _{OUT} = 4.0V/0V	-	-	± 2	
Output High Voltage	V _{OH1}	Push-pull ports	V _{DD} = 4.0V, I _{OH} = - 200μA	2.4	-	-	V
	V _{OH2}	Tri- state ports	V _{DD} = 4.0V, I _{OH} = - 0.7mA	3.6	-	-	
	V _{OH3}	Push- pull ports	V _{DD} = 2.0V, I _{OH} = - 5μA	1.8	-	-	
	V _{OH4}	Tri- state ports	V _{DD} = 2.0V, I _{OH} = - 50μA	1.8	-	-	
Output Low Voltage	V _{OL1}	Except XOUT and port P3	V _{DD} = 4.0V, I _{OL} = 1.6mA	-	-	0.4	V
	V _{OL2}	Except XOUT	V _{DD} = 2.0V, I _{OL} = 50μA	-	-	0.1	
Output Low Current	I _{OL3}	Port P3	V _{DD} = 4.0V, V _{OL} = 1.0V	-	20	-	mA
Supply Current in NORMAL 1, 2 mode	I _{DD}		V _{DD} = 4.0V f _c = 3.7MHz	-	4.5	5.5	mA
Supply Current in IDLE 1, 2 mode			f _s = 32.768KHz V _{IN} = 3.8V / 0.2V	-	3.5	4.0	
Supply Current in NORMAL 1, 2 mode			V _{DD} = 2.0V f _c = 3.7MHz	-	2.5	3.5	mA
Supply Current in IDLE 1, 2 mode			f _s = 32.768KHz V _{IN} = 1.8V / 0.2V	-	1.5	2.0	
Supply Current in SLOW mode			V _{DD} = 2.0V f _s = 32.768KHz	-	20	40	μA
Supply Current in SLEEP mode			V _{IN} = 1.8V / 0.2V	-	10	20	
Supply Current in STOP mode			V _{DD} = 4.0V V _{IN} = 3.8V / 0.2V	-	0.5	10	μA

Note 1 : Typical values show those at T_{opr} = 25°C, V_{DD} = 4V.

Note 2 : Input Current ; The current through pull-up or pull-down resistor is not included.

Note 3 : I_{DD} ; except for I_{REF}

A / D CONVERSION CHARACTERISTICS

($V_{SS} = 0V, V_{DD} = 2.0 \sim 4.0V, T_{opr} = 10 \text{ to } 40^\circ C$)

PARAMETER	SYMBOL	CONDITIONS	Min.	Typ.	Max.	UNIT
Analog Reference Voltage	V_{REF}		2.0	-	V_{DD}	V
	V_{ASS}		V_{SS}	-	V_{REF} -2.0	
Analog Input Voltage	V_{AIN}		V_{ASS}	-	V_{REF}	V
Analog Supply Current	I_{REF}		-	0.5	1.0	mA
Nonlinearity Error		$V_{SS} = 0V, V_{DD} = 2.0 \sim 4.0V$ $V_{REF} = V_{DD}$ $V_{ASS} = V_{SS}$	-	-	± 1	LSB
Zero Point Error			-	-	± 1	
Full Scale Error			-	-	± 1	
Total Error			-	-	± 2	

A.C. CHARACTERISTICS

($V_{SS} = 0V, V_{DD} = 2.0 \text{ to } 4.0V, T_{opr} = 10 \text{ to } 40^\circ C$)

PARAMETER	SYMBOL	CONDITIONS	Min	Typ.	Max.	UNIT
Machine Cycle Time	t_{cy}	In NORMAL 1, 2 mode	1.08	-	10	μs
		In IDLE 1, 2 mode				
		In SLOW mode	117.6	-	133.3	
		In SLEEP mode				
High Level Clock Pulse Width	t_{wCH}	For external clock operation (XIN input), $f_c = 3.7MHz$	135	-	-	ns
Low Level Clock Pulse Width	t_{wCL}					
High Level Clock Pulse Width	t_{wSH}	For external clock operation (XTIN input), $f_s = 32.768kHz$	14.7	-	-	μs
Low Level Clock Pulse Width	t_{wSL}					

D.C./A.C. CHARACTERISTICS (PROM mode) ($V_{SS} = 0V$)

(1) Read Operation

PARAMETER	SYMBOL	CONDITIONS	Min.	Typ.	Max.	UNIT
Input High Voltage	V_{IH2}		$V_{CC} \times 0.7$	-	V_{CC}	V
Input Low Voltage	V_{IL2}		0	-	$V_{CC} \times 0.12$	V
Power Supply Voltage	V_{CC}		4.75	-	6.0	V
Program Power Supply Voltage	V_{PP}					V
Address Access Time	t_{ACC}	$V_{CC} = 5.0 \pm 0.25V$	-	$1.5t_{cyc} + 300$	-	ns

Note : $t_{cyc} = 1.08\mu s$ at 3.7MHz

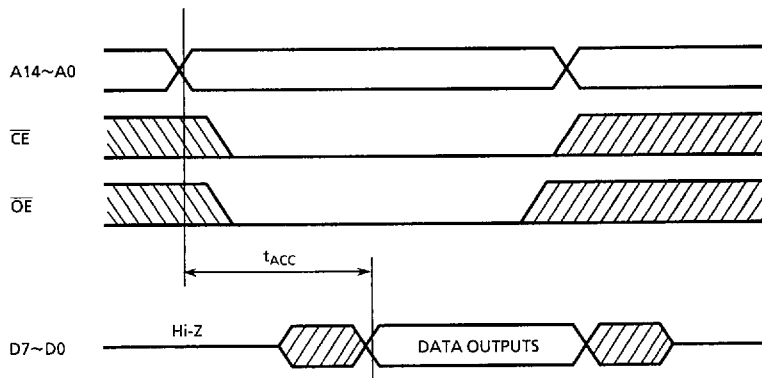

TIMING WAVEFORMS OF READ OPERATION

(2) High-Speed Programming Operation

PARAMETER	SYMBOL	CONDITIONS	Min.	Typ.	Max.	UNIT
Input High Voltage	V_{IH2}		$V_{CC} \times 0.7$	-	V_{CC}	V
Input Low Voltage	V_{IL2}		0	-	$V_{CC} \times 0.12$	V
Power Supply Voltage	V_{CC}		4.75	-	6.0	V
Program Power Supply Voltage	V_{PP}		12.0	12.5	13.0	V
Initial Program Pulse Width	t_{PW}	$V_{CC} = 6.0V$	0.95	1.0	1.05	ms

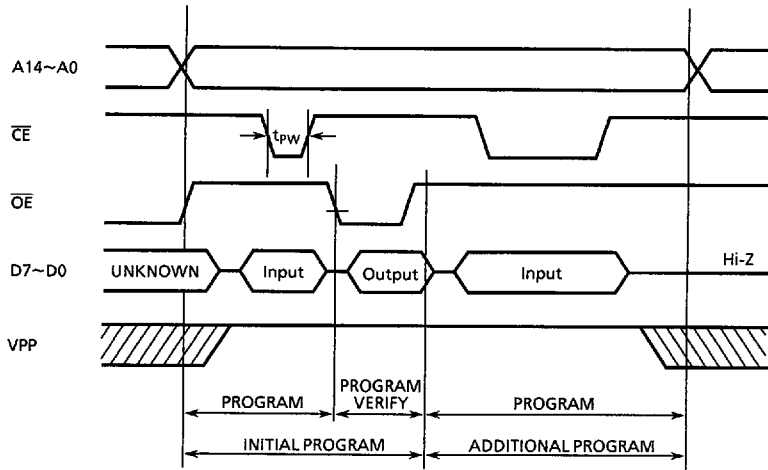

TIMING WAVEFORMS OF PROGRAMMING OPERATION