

N-channel MOSFET

Features

- Low gate charge
- Improved dv/dt capability
- Improved ESD performance
- RoHS compliant
- JEDEC Qualification

BV_{DSS}	I_D	$R_{DS(on)}$
900V	9A	<1.4Ω

Top view TO-220F

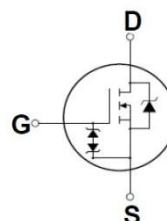
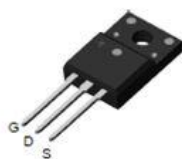

Ordering Part Number	Package	Marking	Remark
TMPF9N90AZ	TO-220F	TMPF9N90AZ	RoHS

Absolute Maximum Ratings

Parameter	Symbol	Value	Unit
Drain-Source Voltage	V_{DSS}	900	V
Gate-Source Voltage	V_{GS}	±30	V
Continuous Drain Current	I_D	$T_C = 25\text{ °C}$	9*
		$T_C = 100\text{ °C}$	5.9 *
Pulsed Drain Current (Note 1)	I_{DM}	36*	A
Single Pulse Avalanche Energy (Note 2)	E_{AS}	454	mJ
Repetitive Avalanche Current (Note 1)	I_{AR}	9	A
Repetitive Avalanche Energy (Note 1)	E_{AR}	29	mJ
Power Dissipation	P_D	$T_C = 25\text{ °C}$	89
		Derate above 25 °C	0.71
Peak Diode Recovery dv/dt (Note 3)	dv/dt	4.5	V/ns
Operating Junction and Storage Temperature Range	T_J, T_{STG}	-55~150	°C
Maximum lead temperature for soldering purposes, 1/8" from case for 5 seconds	T_L	300	°C

* Limited only by maximum junction temperature

Thermal Characteristics

Parameter	Symbol	Value	Unit
Maximum Thermal resistance, Junction-to-Case	$R_{\theta JC}$	1.4	°C/W
Maximum Thermal resistance, Junction-to-Ambient	$R_{\theta JA}$	62.5	°C/W

Electrical Characteristics : $T_C=25^\circ\text{C}$, unless otherwise noted

Parameter	Symbol	Test condition	Min	Typ	Max	Unit
OFF						
Drain-Source Breakdown Voltage	BV_{DSS}	$V_{GS} = 0\text{ V}, I_D = 250\ \mu\text{A}$	900	--	--	V
Zero Gate Voltage Drain Current	I_{DSS}	$V_{DS} = 900\text{ V}, V_{GS} = 0\text{ V}$	--	--	10	μA
		$V_{DS} = 720\text{ V}, T_C = 125^\circ\text{C}$	--	--	100	μA
Forward Gate-Source Leakage Current	I_{GSSF}	$V_{GS} = 30\text{ V}, V_{DS} = 0\text{ V}$	--	--	100	μA
Reverse Gate-Source Leakage Current	I_{GSSR}	$V_{GS} = -30\text{ V}, V_{DS} = 0\text{ V}$	--	--	-100	μA

ON

Gate Threshold Voltage	$V_{GS(th)}$	$V_{DS} = V_{GS}, I_D = 250\ \mu\text{A}$	2.0	--	4.0	V
Drain-Source On-Resistance	$R_{DS(on)}$	$V_{GS} = 10\text{ V}, I_D = 4.5\text{ A}$	--	1.12	1.4	Ω
Forward Transconductance ^(Note 4)	g_{FS}	$V_{DS} = 30\text{ V}, I_D = 4.5\text{ A}$	--	17	--	S

DYNAMIC

Input Capacitance	C_{iss}	$V_{DS} = 25\text{ V}, V_{GS} = 0\text{ V},$ $f = 1.0\text{ MHz}$	--	2740	--	pF
Output Capacitance	C_{oss}		--	192	--	pF
Reverse Transfer Capacitance	C_{rss}		--	27	--	pF

SWITCHING

Turn-On Delay Time ^(Note 4,5)	$t_{d(on)}$	$V_{DD} = 450\text{ V}, I_D = 9\text{ A},$ $R_G = 25\ \Omega$	--	52	--	ns
Turn-On Rise Time ^(Note 4,5)	t_r		--	97	--	ns
Turn-Off Delay Time ^(Note 4,5)	$t_{d(off)}$		--	212	--	ns
Turn-Off Fall Time ^(Note 4,5)	t_f		--	159	--	ns
Total Gate Charge ^(Note 4,5)	Q_g	$V_{DS} = 720\text{ V}, I_D = 9\text{ A},$ $V_{GS} = 10\text{ V}$	--	72	--	nC
Gate-Source Charge ^(Note 4,5)	Q_{gs}		--	11	--	nC
Gate-Drain Charge ^(Note 4,5)	Q_{gd}		--	31	--	nC

SOURCE DRAIN DIODE

Maximum Continuous Drain-Source Diode Forward Current	I_S	----	--	--	9.0	A
Maximum Pulsed Drain-Source Diode Forward Current	I_{SM}	----	--	--	38	A
Drain-Source Diode Forward Voltage	V_{SD}	$V_{GS} = 0\text{ V}, I_S = 9\text{ A}$	--	--	1.5	V
Reverse Recovery Time ^(Note 4)	t_{rr}	$V_{GS} = 0\text{ V}, I_S = 9\text{ A}$	--	570	--	ns
Reverse Recovery Charge ^(Note 4)	Q_{rr}	$di_F / dt = 100\text{ A}/\mu\text{s}$	--	6.6	--	μC

Note :

1. Repeated rating : Pulse width limited by safe operating area
2. $L=10.6\text{mH}, I_{AS} = 9\text{A}, V_{DD} = 50\text{V}, R_G = 25\Omega$, Starting $T_J = 25^\circ\text{C}$, not subject to production test – verified by design/characterization
3. $I_{SD} \leq 9\text{A}, di/dt \leq 200\text{A}/\mu\text{s}, V_{DD} \leq BV_{DS}$, Starting $T_J = 25^\circ\text{C}$
4. Pulse Test : Pulse width $\leq 300\mu\text{s}$, Duty Cycle $\leq 2\%$
5. Essentially Independent of Operating Temperature Typical Characteristics

Fig. 1 Output Characteristics

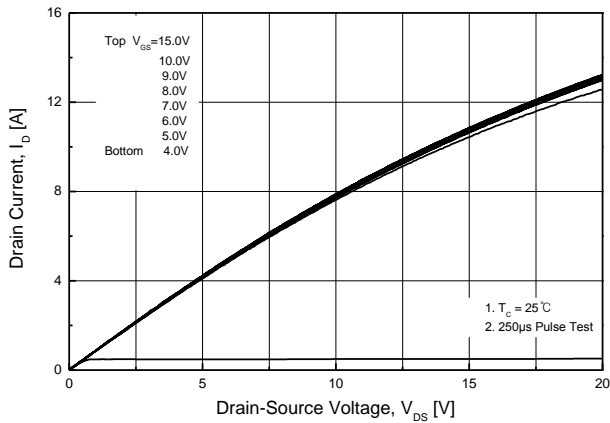

Fig. 2 Transfer Characteristics

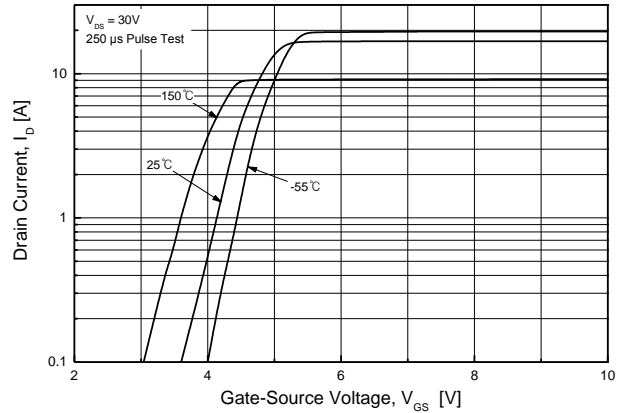

Fig. 3 On-Resistance vs. Drain Current and Gate voltage

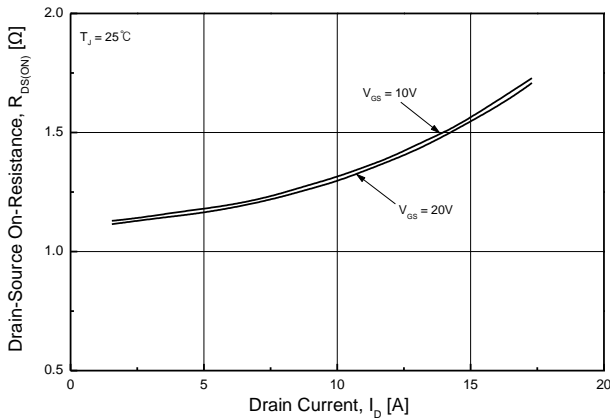

Fig. 4 Body Diode Forward Voltage vs. Source Current and Temperature

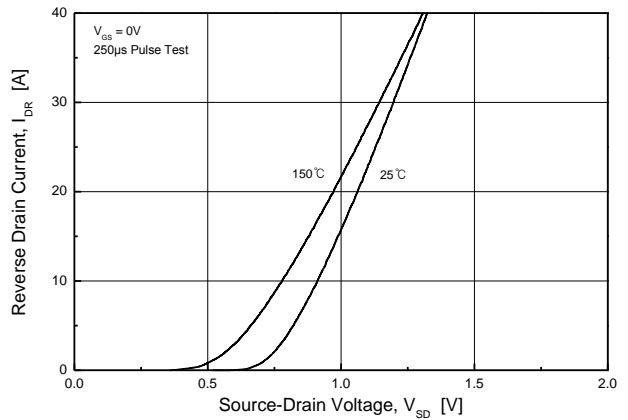

Fig. 5 Capacitance Characteristics

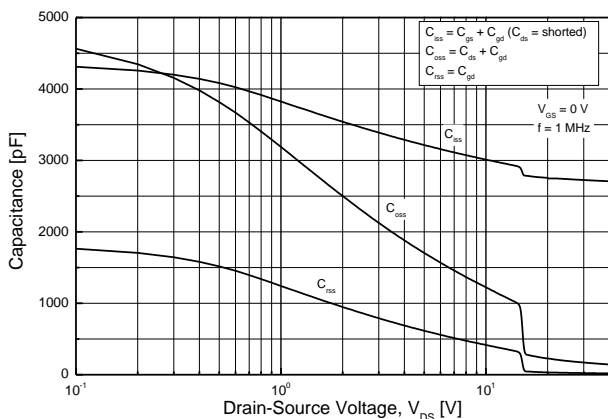

Fig. 6 Gate Charge Characteristics

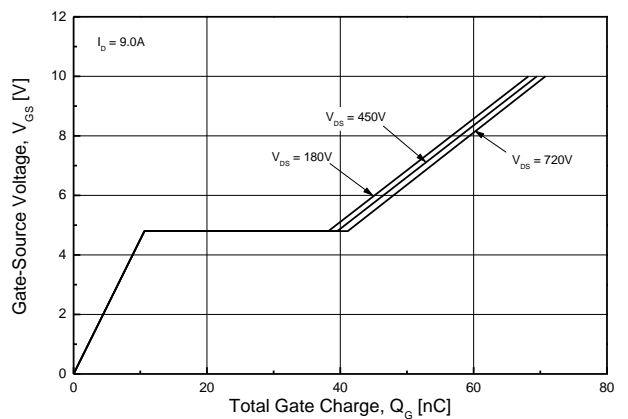

Fig. 7 Breakdown Voltage vs. Temperature

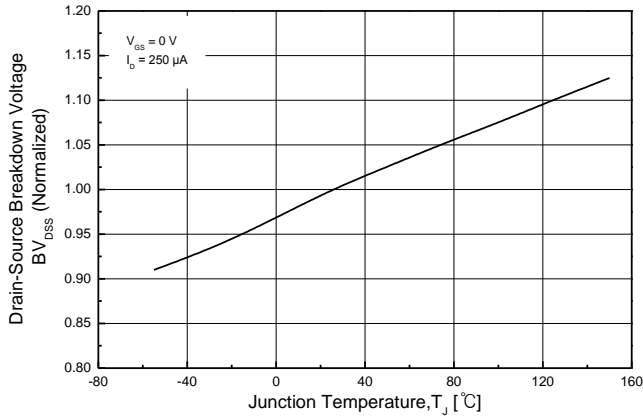

Fig. 8 On-Resistance vs. Temperature

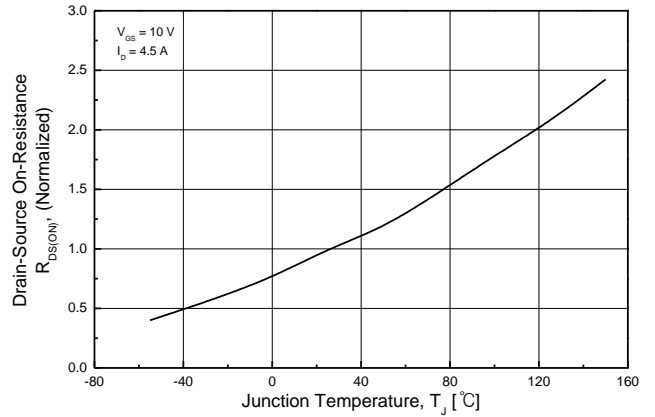

Fig. 9 Maximum Drain Current vs. Case Temperature

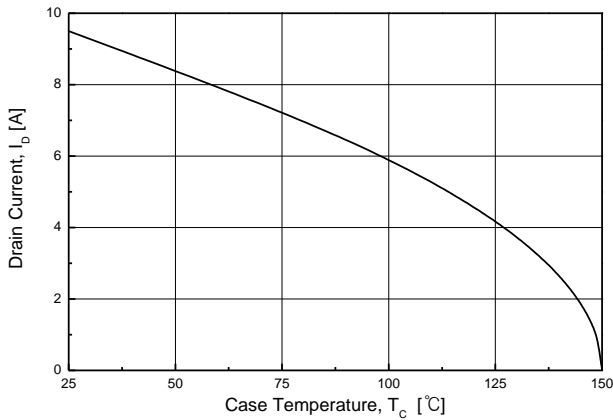

Fig. 10 Gate Threshold Voltage vs. Junction Temperature

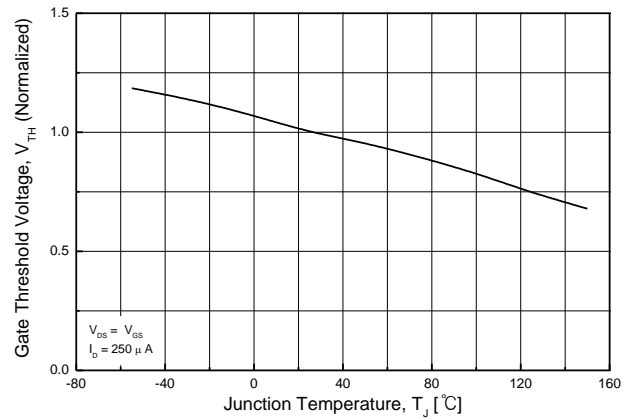

Fig. 11 Maximum Safe Operating Area

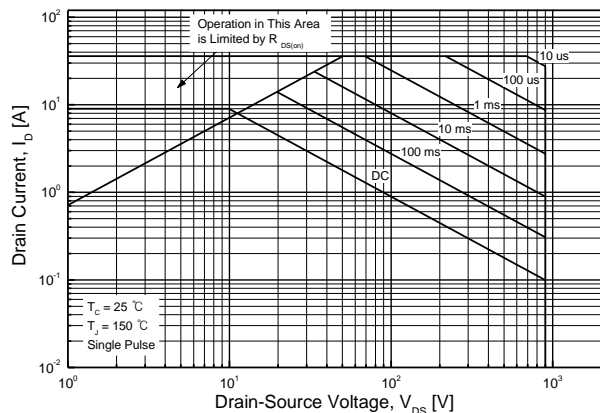
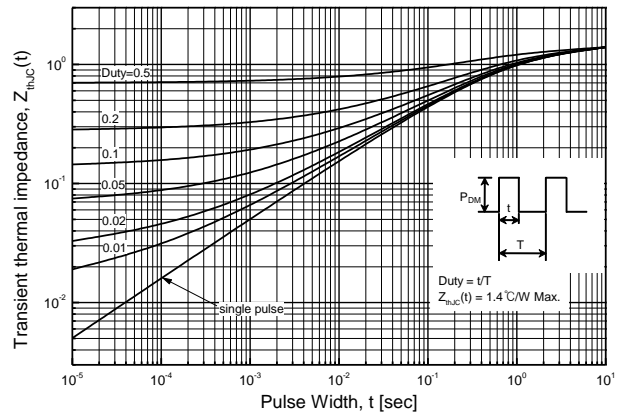
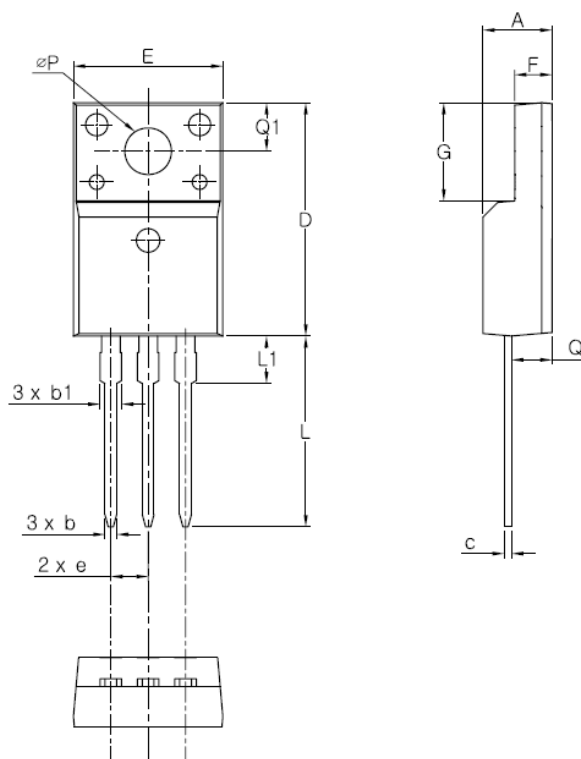

Fig. 12 Transient Thermal Response Curve



TO-220F-3L MECHANICAL DATA

SYMBOL	MIN	MAX
A	4.50	4.93
b	0.70	0.91
b1	1.15	1.47
c	0.36	0.60
D	15.67	16.07
E	6.96	10.36
e	2.54 BSC	
F	2.34	2.74
G	6.48	6.90
L	12.37	13.18
L1	2.23	3.43
Q	2.56	2.96
Q1	3.10	3.50
ØP	2.98	3.38

Disclaimer :

TRinno technology reserves the right to make changes without notice to products herein to improve reliability, performance, or design. The information given in this document is believed to be accurate and reliable. However, it shall in no event be regarded as a guarantee of conditions and characteristics. With respect to any information regarding the application of the device, TRinno technology hereby disclaims any and all warranties and liabilities of any kind, including without limitation, warranties of non-infringement of patent rights of any third party.