

TMS28F010B
131072 BY 8-BIT
FLASH MEMORY

SMJS824B – MAY 1995 – REVISED AUGUST 1997

- Organization . . . 131 072 by 8 Bits
- Pin Compatible With Existing 1-Megabit EPROMs
- V_{CC} Tolerance $\pm 10\%$
- All Inputs/Outputs TTL Compatible
- Maximum Access/Minimum Cycle Time
 - '28F010B-90 90 ns
 - '28F010B-10 100 ns
 - '28F010B-12 120 ns
 - '28F010B-15 150 ns
- Industry-Standard Programming Algorithm
- PEP4 Version Available With 168-Hour Burn-In, and Choice of Operating Temperature Ranges
- 100000 and 10000 Program/Erase-Cycle Versions Available
- Latchup Immunity of 250 mA on All Input and Output Lines
- Low Power Dissipation ($V_{CC} = 5.5 V$)
 - Active Write . . . 55 mW
 - Active Read . . . 165 mW
 - Electrical Erase . . . 82.5 mW
 - Standby . . . 0.55 mW (CMOS-Input Levels)
- Automotive Temperature Range
 - 40°C to 125°C

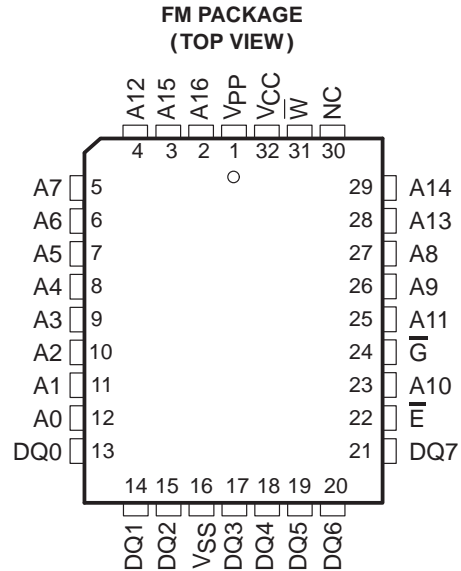

PIN NOMENCLATURE	
A0–A16	Address Inputs
DQ0–DQ7	Inputs (programming)/Outputs
\bar{E}	Chip Enable
\bar{G}	Output Enable
NC	No Internal Connection
V_{CC}	5-V Power Supply
V_{PP}	12-V Power Supply†
V_{SS}	Ground
W	Write Enable

† Only in Program Mode

description

The TMS28F010B is a 131 072 by 8 bit (104 8576-bit), programmable read-only memory that can be electrically bulk-erased and reprogrammed. It is available in 100 000 and 10 000 program/erase-endurance-cycle versions.

The TMS28F010B Flash Memory is offered in a 32-lead plastic leaded chip-carrier package (shown above) using 1,25-mm (50-mil) lead spacing (FM suffix), a 32-lead thin small-outline package (DD suffix), and a reverse pinout TSOP package (DU suffix) both shown on the following page.



Please be aware that an important notice concerning availability, standard warranty, and use in critical applications of Texas Instruments semiconductor products and disclaimers thereto appears at the end of this data sheet.

PRODUCTION DATA information is current as of publication date. Products conform to specifications per the terms of Texas Instruments standard warranty. Production processing does not necessarily include testing of all parameters.



POST OFFICE BOX 1443 • HOUSTON, TEXAS 77251-1443

Copyright © 1997, Texas Instruments Incorporated

TMS28F010B
131072 BY 8-BIT
FLASH MEMORY

SMJS824B – MAY 1995 – REVISED AUGUST 1997

DD PACKAGE
(TOP VIEW)



DU PACKAGE
REVERSE PINOUT
(TOP VIEW)



device symbol nomenclature

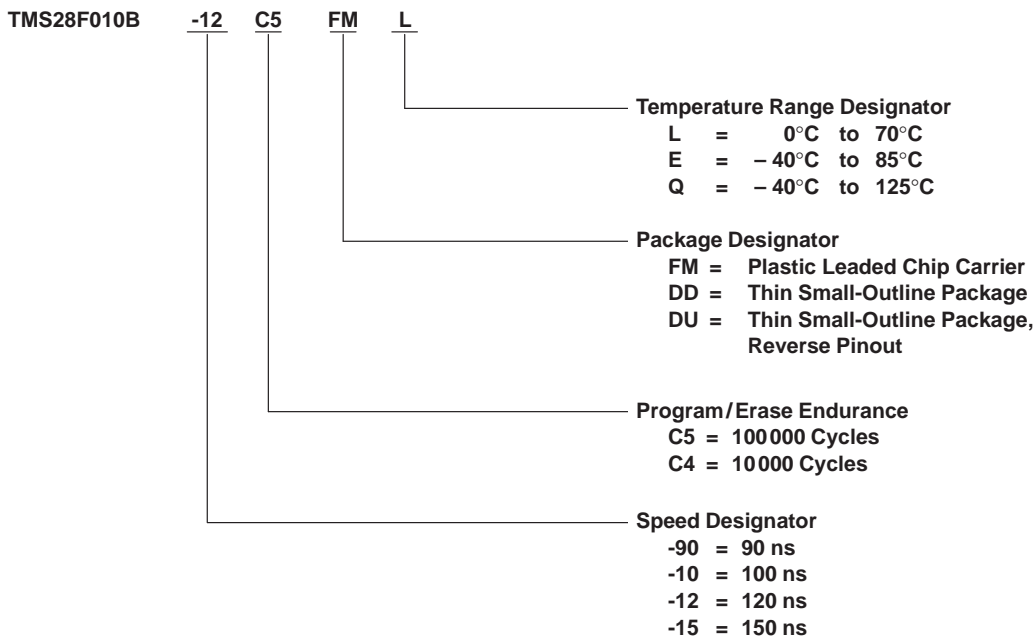

TMS28F010B
131072 BY 8-BIT
FLASH MEMORY

SMJS824B – MAY 1995 – REVISED AUGUST 1997

logic symbol†

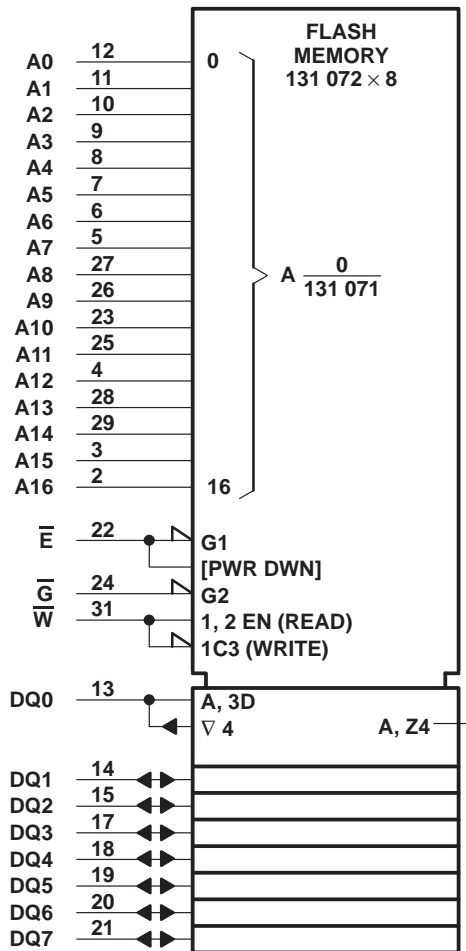

† This symbol is in accordance with ANSI/IEEE Std 91-1984 and IEC Publication 617-12.
 Pin numbers shown are for the FM package.

functional block diagram

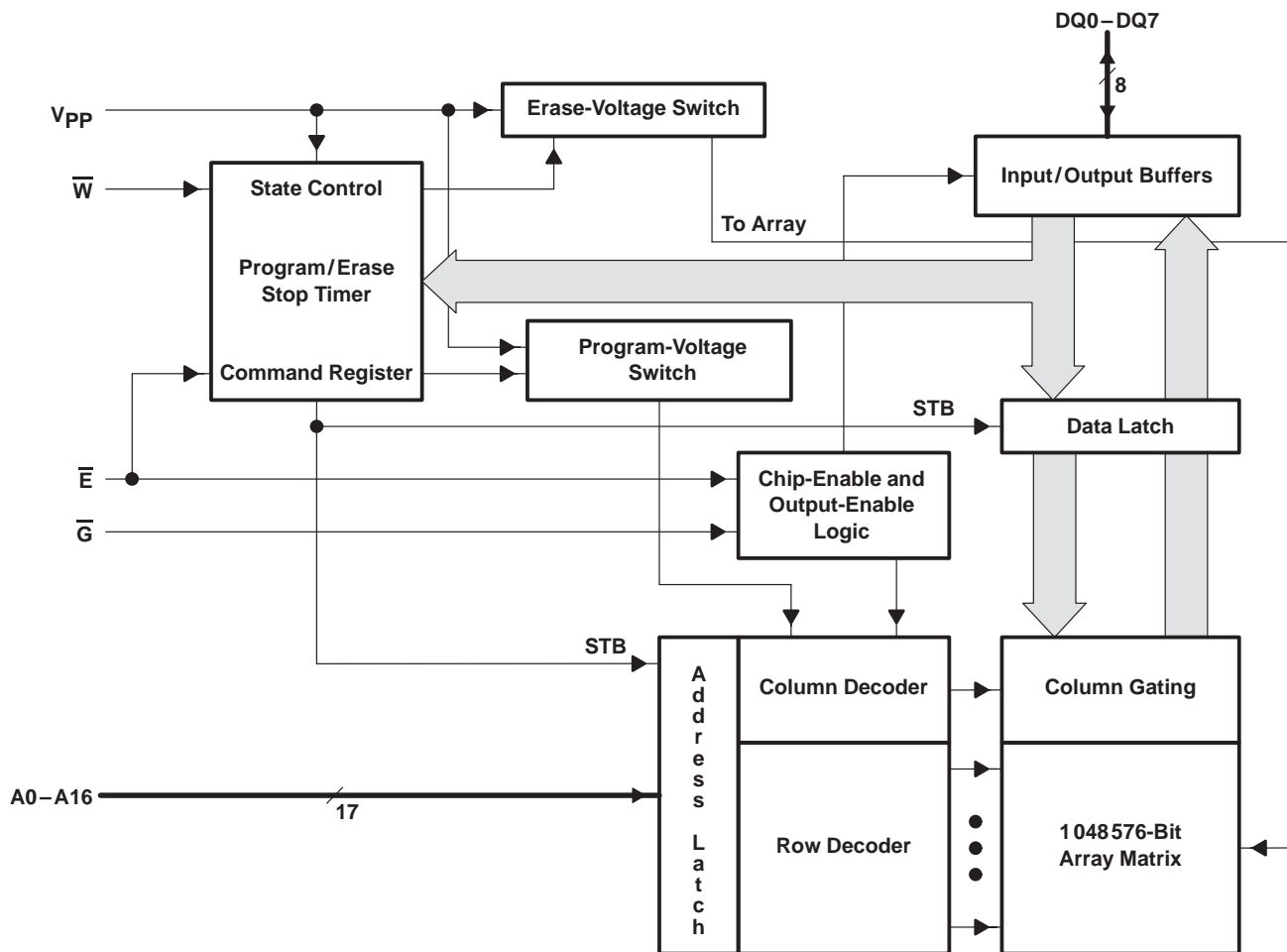

TMS28F010B

131072 BY 8-BIT

FLASH MEMORY

SMJS824B – MAY 1995 – REVISED AUGUST 1997

operation

Modes of operation are shown in Table 1.

Table 1. Operation Modes

MODE		FUNCTION†						
		V _{PP} ‡ (1)	\bar{E} (22)	\bar{G} (24)	A0 (12)	A9 (26)	\bar{W} (31)	DQ0–DQ7 (13–15, 17–21)
Read	Read	V _{PPL}	V _{IL}	V _{IL}	X	X	V _{IH}	Data Out
	Output Disable	V _{PPL}	V _{IL}	V _{IH}	X	X	V _{IH}	Hi-Z
	Standby and Write Inhibit	V _{PPL}	V _{IH}	X	X	X	X	Hi-Z
	Algorithm-Selection Mode	V _{PPL}	V _{IL}	V _{IL}	V _{IL} V _{IH}	V _{ID}	V _{IH}	Mfr Equivalent Code 89h Device Equivalent Code B4h
Read/ Write	Read	V _{PPH}	V _{IL}	V _{IL}	X	X	V _{IH}	Data Out
	Output Disable	V _{PPH}	V _{IL}	V _{IH}	X	X	V _{IH}	Hi-Z
	Standby and Write Inhibit	V _{PPH}	V _{IH}	X	X	X	X	Hi-Z
	Write	V _{PPH}	V _{IL}	V _{IH}	X	X	V _{IL}	Data In

† X can be V_{IL} or V_{IH}.

‡ V_{PPL} ≤ V_{CC} + 2 V; V_{PPH} is the programming voltage specified for the device. For more details, refer to the recommended operating conditions.

read/output disable

When the outputs of two or more TMS28F010Bs are connected in parallel on the same bus, the output of any particular device in the circuit can be read with no interference from the competing outputs of other devices. To read the output of the TMS28F010B, a low-level signal is applied to the \bar{E} and \bar{G} pins. All other devices in the circuit should have their outputs disabled by applying a high-level signal to one of these pins.

standby and write inhibit

Active I_{CC} current can be reduced from 30 mA to 1 mA by applying a high TTL level on \bar{E} or to 100 μA with a high CMOS level on \bar{E} . In this mode, all outputs are in the high-impedance state. The TMS28F010B draws active current when it is deselected during programming, erasure, or program/erase verification. It continues to draw active current until the operation is terminated.

algorithm-selection mode

The algorithm-selection mode provides access to a binary code identifying the correct programming and erase algorithms. This mode is activated when A9 (pin 26) is forced to V_{ID}. Two identifier bytes are accessed by toggling A0. All other addresses must be held low. A0 low selects the manufacturer equivalent code 89h, and A0 high selects the device equivalent code B4h, as shown in Table 2.

Table 2. Algorithm-Selection Modes

IDENTIFIER§	PINS									
	A0	DQ7	DQ6	DQ5	DQ4	DQ3	DQ2	DQ1	DQ0	HEX
Manufacturer Equivalent Code	V _{IL}	1	0	0	0	1	0	0	1	89
Device Equivalent Code	V _{IH}	1	0	1	1	0	1	0	0	B4

§ $\bar{E} = \bar{G} = V_{IL}$, A1–A8 = V_{IL}, A9 = V_{ID}, A10–A16 = V_{IL}, V_{PP} = V_{PPL}.

programming and erasure

In the erased state, all bits are at a logic 1. Before erasing the device, all memory bits must be programmed to a logic 0. Afterwards, the entire chip is erased. At this point, the bits, now logic 1s, can be programmed accordingly. Refer to the Fastwrite and Fasterase algorithms for further detail.



command register

The command register controls the program and erase functions of the TMS28F010B. The algorithm-selection mode can be activated using the command register in addition to the previously described method. When V_{PP} is high, the contents of the command register and the function being performed can be changed. The command register is written to when \bar{E} is low and \bar{W} is pulsed low. The address is latched on the leading edge of the pulse, while the data is latched on the trailing edge. Accidental programming or erasure is minimized because two commands must be executed to invoke either operation. The command register is inhibited when V_{CC} is below the erase/write lockout voltage, V_{LKO} .

power supply considerations

Each device should have a 0.1- μ F ceramic capacitor connected between V_{CC} and V_{SS} to suppress circuit noise. Changes in current drain on V_{PP} require it to have a bypass capacitor as well. Printed-circuit traces for both power supplies should be appropriate to handle the current demand.

command definitions

See Table 3 for command definitions.

Table 3. Command Definitions

COMMAND	REQUIRED BUS CYCLES	FIRST BUS CYCLE			SECOND BUS CYCLE		
		OPERATION†	ADDRESS	DATA	OPERATION†	ADDRESS	DATA
Read	1	Write	X	00h	Read	RA	RD
Algorithm-Selection Mode	3	Write	X	90h	Read	0000 0001	89h B4h
Set-Up-Erase/Erase	2	Write	X	20h	Write	X	20h
Erase Verify	2	Write	EA	A0h	Read	X	EVD
Set-Up-Program/Program	2	Write	X	40h	Write	PA	PD
Program Verify	2	Write	X	C0h	Read	X	PVD
Reset	2	Write	X	FFh	Write	X	FFh

† Modes of operation are defined in Table 1.

Legend:

- EA Address of memory location to be read during erase verify
- RA Address of memory location to be read
- PA Address of memory location to be programmed. Address is latched on the falling edge of \bar{W}
- RD Data read from location RA during the read operation
- EVD Data read from location EA during erase verify
- PD Data to be programmed at location PA. Data is latched on the rising edge of \bar{W}
- PVD Data read from location PA during program verify

read command

Memory contents can be accessed while V_{PP} is high or low. When V_{PP} is high, writing 00h into the command register invokes the read operation. When the device is powered up, the default contents of the command register are 00h and the read operation is enabled. The read operation remains enabled until a different valid command is written to the command register.

algorithm-selection mode command

The algorithm-selection mode is activated by writing 90h into the command register. The manufacturer-equivalent code (89h) is identified by the value read from address location 0000h, and the device-equivalent code (B4h) is identified by the value read from address location 0001h.

command definitions (continued)

set-up-erase/erase commands

The erase-algorithm initiates with $\overline{E} = V_{IL}$, $\overline{W} = V_{IL}$, $\overline{G} = V_{IH}$, $V_{PP} = V_{PPH}$, and $V_{CC} = 5\text{ V}$. To enter the erase mode, write the set-up-erase command, 20h, into the command register. After the TMS28F010B is in the erase mode, writing a second erase command, 20h, into the command register invokes the erase operation. The erase operation begins on the rising edge of \overline{W} and ends on the rising edge of the next \overline{W} . The erase operation requires at least 9.5 ms to complete before the erase-verify command, A0h, can be loaded.

Maximum erase timing is controlled by the internal stop timer. When the stop timer terminates the erase operation, the device enters an inactive state and remains inactive until a command is received.

program-verify command

The TMS28F010B can be programmed sequentially or randomly because it is programmed one byte at a time. Each byte must be verified after it is programmed. The program-verify operation prepares the device to verify the most recently programmed byte. To invoke the program-verify operation, C0h must be written into the command register. The program-verify operation ends on the rising edge of \overline{W} .

While verifying a byte, the TMS28F010B applies an internal margin voltage to the designated byte. If the true data and programmed data match, programming continues to the next designated byte location; otherwise, the byte must be reprogrammed. Figure 1 shows how commands and bus operations are combined for byte programming.

erase-verify command

All bytes must be verified following an erase operation. After the erase operation is complete, an erased byte can be verified by writing the erase-verify command, A0h, into the command register. This command causes the device to exit the erase mode on the rising edge of \overline{W} . The address of the byte to be verified is latched on the falling edge of \overline{W} . The erase-verify operation remains enabled until a command is written to the command register.

To determine whether or not all the bytes have been erased, the TMS28F010B applies a margin voltage to each byte. If FFh is read from the byte, all bits in the designated byte have been erased. The erase-verify operation continues until all of the bytes have been verified. If FFh is not read from a byte, an additional erase operation needs to be executed. Figure 2 shows the combination of commands and bus operations for electrically erasing the TMS28F010B.

set-up-program/program commands

The programming algorithm initiates with $\overline{E} = V_{IL}$, $\overline{W} = V_{IL}$, $\overline{G} = V_{IH}$, $V_{PP} = V_{PPH}$, and $V_{CC} = 5\text{ V}$. To enter the programming mode, write the set-up-program command, 40h, into the command register. The programming operation is invoked by the next write-enable pulse. Addresses are latched internally on the falling edge of \overline{W} , and data is latched internally on the rising edge of \overline{W} . The programming operation begins on the rising edge of \overline{W} and ends on the rising edge of the next \overline{W} pulse. The program operation requires 10 μs for completion before the program-verify command, C0h, can be loaded.

Maximum program timing is controlled by the internal stop timer. When the stop timer terminates the program operation, the device enters an inactive state and remains inactive until a command is received.

reset command

To reset the TMS28F010B after set-up-erase command or set-up-program command operations without changing the contents in memory, write FFh into the command register two consecutive times. After executing the reset command, the device defaults to the read mode.

Fastwrite algorithm

The TMS28F010B is programmed using the Texas Instruments Fastwrite algorithm shown in Figure 1. This algorithm programs in a nominal time of two seconds.

Fasterase algorithm

The TMS28F010B is erased using the Texas Instruments Fasterase algorithm shown in Figure 2. The memory array needs to be completely programmed (using the Fastwrite algorithm) before erasure begins. Erasure typically occurs in one second.

parallel erasure

To reduce total erase time, several devices can be erased in parallel. Since each Flash Memory can erase at a different rate, every device must be verified separately after each erase pulse. After a given device has been successfully erased, the erase command should not be issued to this device again. All devices that complete erasure should be masked until the parallel erasure process is finished (see Figure 3).

Examples of how to mask a device during parallel erase include driving the \bar{E} pin high, writing the read command (00h) to the device when the others receive a set-up-erase or erase command, or disconnecting it from all electrical signals with relays or other types of switches.

TMS28F010B
131072 BY 8-BIT
FLASH MEMORY

SMJS824B – MAY 1995 – REVISED AUGUST 1997

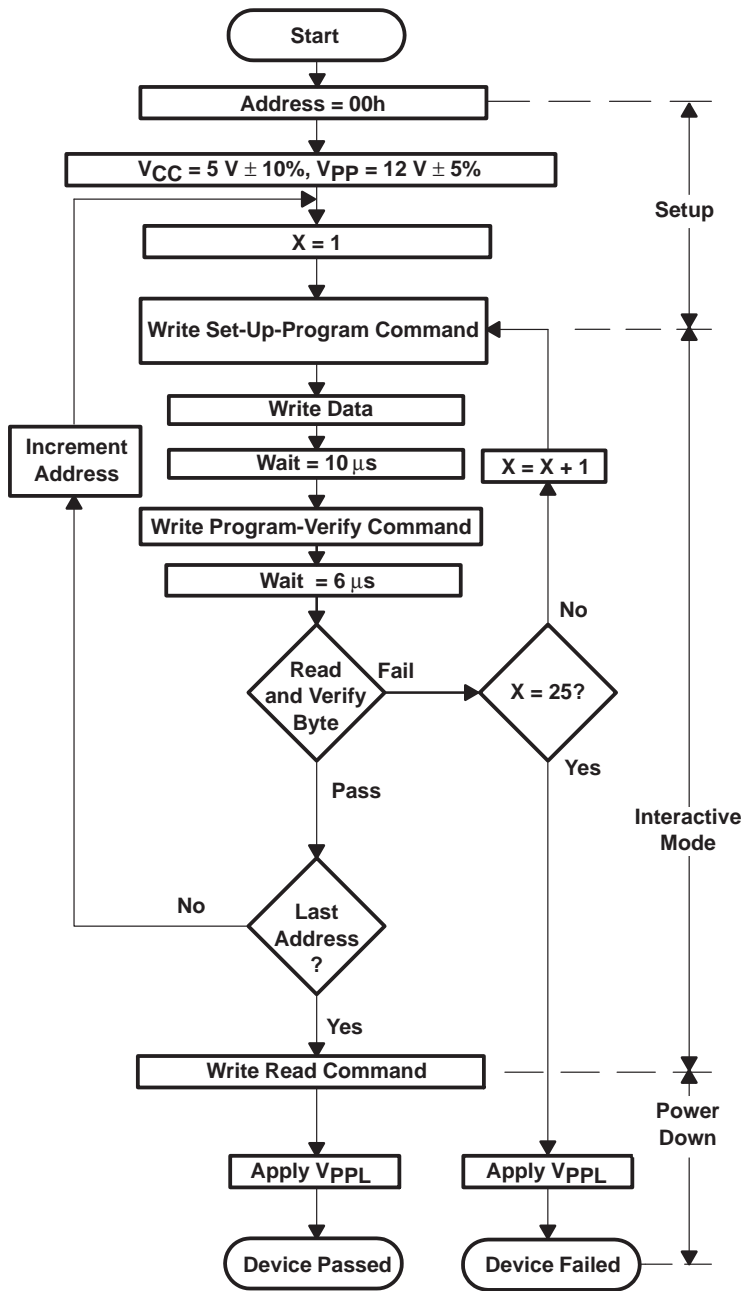

Bus Operation	Command	Comments
Initialize Address		
Standby		Wait for V _{pp} to ramp to V _{ppH} (see Note A) Initialize pulse count
Write	Set-Up-Program Write	Data = 40h
Write	Write Data	Valid address/data
Standby		Wait = 10 μs
Write	Program-Verify	Data = C0h; ends Program operation
Standby		Wait = 6 μs
Read		Read byte to verify Programming; compare output to expected output
—	—	—
Write	Read	Data = 00h; resets register for read operations
Standby		Wait for V _{pp} to ramp to V _{ppL} (see Note B)

NOTES: A. Refer to the recommended operating conditions for the value of V_{ppH}.
 B. Refer to the recommended operating conditions for the value of V_{ppL}.

Figure 1. Programming Flowchart: Fastwrite Algorithm



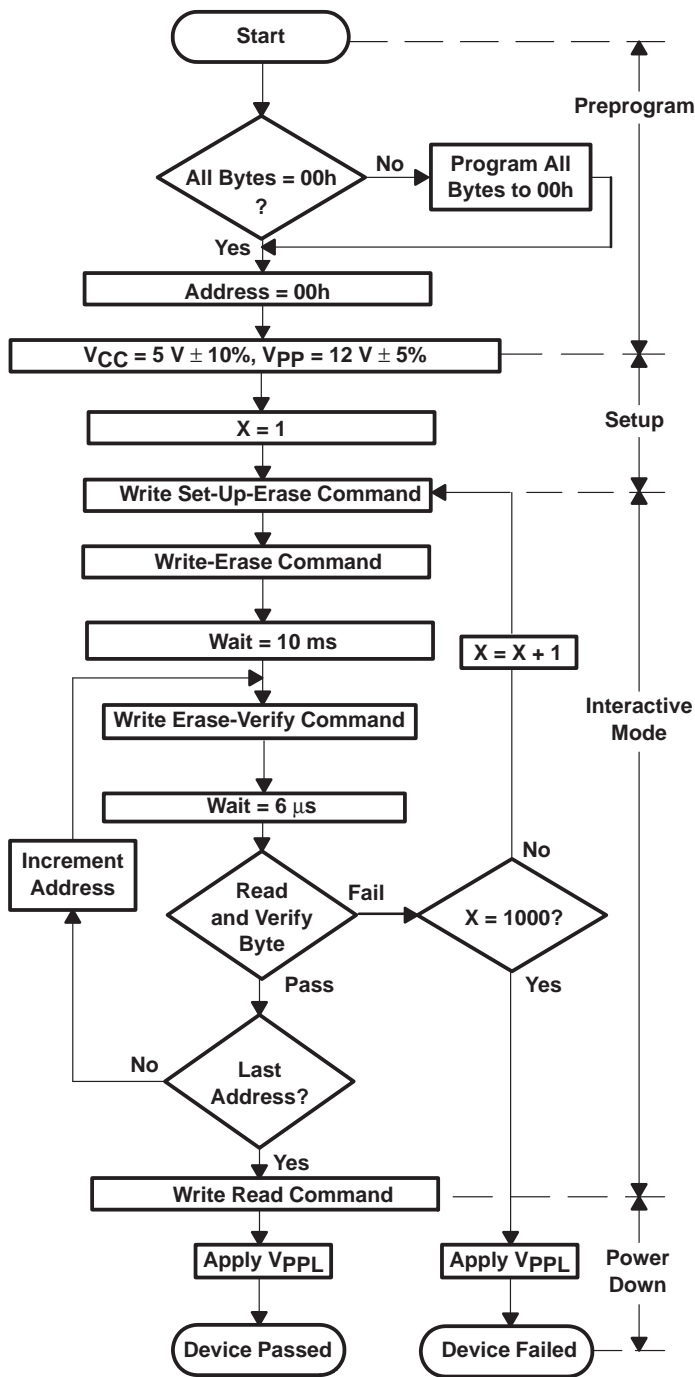

Bus Operation	Command	Comments
		Entire memory must = 00h before erasure Use Fastwrite programming algorithm
		Initialize addresses
Standby		Wait for V _{PP} to ramp to V _{PPH} (see Note A)
		Initialize pulse count
Write	Set-Up-Erase	Data = 20h
Write	Erase	Data = 20h
Standby		Wait = 10 ms
Write	Erase Verify	Addr = Byte to verify; Data = A0h; ends the erase operation
Standby		Wait = 6 μs
Read		Read byte to verify erasure; compare output to FFh
Write	Read	Data = 00h; resets register for read operations
Standby		Wait for V _{PP} to ramp to V _{PLL} (see Note B)

NOTES: A. Refer to the recommended operating conditions for the value of V_{PPH}.
B. Refer to the recommended operating conditions for the value of V_{PLL}.

Figure 2. Flash-Erase Flowchart: Fasterase Algorithm

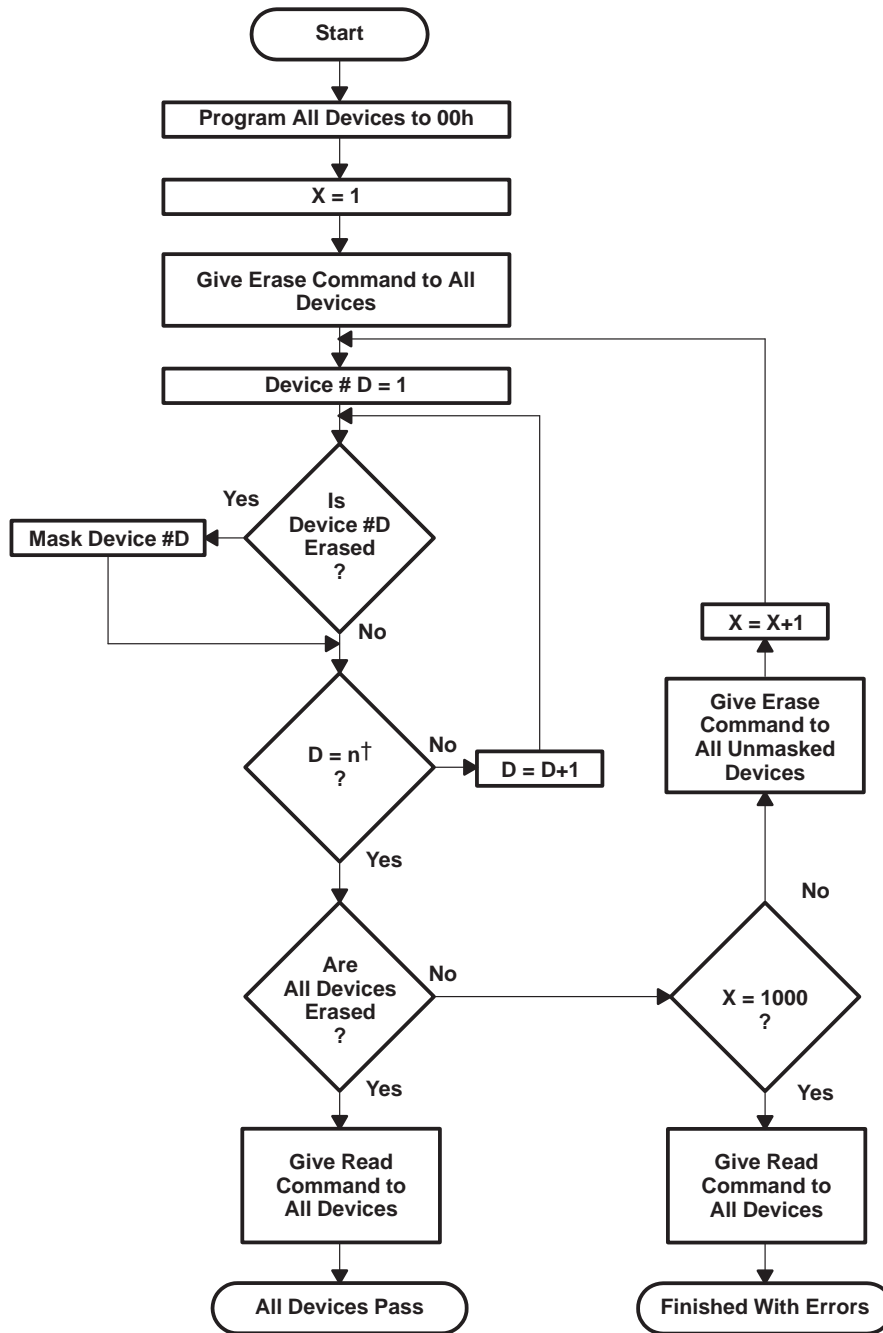

† n = number of devices being erased.

Figure 3. Parallel-Erase Flow Diagram

absolute maximum ratings over operating free-air temperature range (unless otherwise noted)†

Supply voltage range, V_{CC} (see Note 1)	–0.6 V to 7 V
Supply voltage range, V_{PP}	–0.6 V to 14 V
Input voltage range (see Note 2): All inputs except A9	–0.6 V to $V_{CC} + 1$ V
A9	–0.6 V to 13.5 V
Output voltage range (see Note 3)	–0.6 V to $V_{CC} + 1$ V
Operating free-air temperature range during read/erase/program, T_A	
L	0°C to 70°C
E	–40°C to 85°C
Q	–40°C to 125°C
Storage temperature range, T_{stg}	–65°C to 150°C

† Stresses beyond those listed under “absolute maximum ratings” may cause permanent damage to the device. These are stress ratings only, and functional operation of the device at these or any other conditions beyond those indicated under “recommended operating conditions” is not implied. Exposure to absolute-maximum-rated conditions for extended periods may affect device reliability.

- NOTES: 1. All voltage values are with respect to V_{SS} .
2. The voltage on any input pin can undershoot to –2 V for periods less than 20 ns.
3. The voltage on any output pin can overshoot to 7 V for periods less than 20 ns.

recommended operating conditions

			MIN	TYP	MAX	UNIT
V_{CC}	Supply voltage	During write/read/flash erase	4.5	5	5.5	V
V_{PP}	Supply voltage	During read only (V_{PPL})	0		$V_{CC} + 2$	V
		During write/read/flash erase (V_{PPH})	11.4	12	12.6	V
V_{IH}	High-level dc input voltage	TTL	2		$V_{CC} + 0.5$	V
		CMOS	$V_{CC} - 0.5$		$V_{CC} + 0.5$	
V_{IL}	Low-level dc input voltage	TTL	–0.5		0.8	V
		CMOS	GND – 0.2		GND + 0.2	
V_{ID}	Voltage level on A9 for algorithm-selection mode		11.5		13	V

TMS28F010B
131072 BY 8-BIT
FLASH MEMORY

SMJS824B – MAY 1995 – REVISED AUGUST 1997

electrical characteristics over recommended ranges of supply voltage and operating free-air temperature

PARAMETER		TEST CONDITIONS	MIN	MAX	UNIT
V _{OH}	High-level output voltage	I _{OH} = - 2.5 mA	2.4		V
		I _{OH} = - 100 μA	V _{CC} - 0.4		
V _{OL}	Low-level output voltage	I _{OL} = 5.8 mA	0.45		V
		I _{OL} = 100 μA	0.1		
I _{ID}	A9 algorithm-selection-mode current	A9 = V _{ID} max	200		μA
I _I	Input current (leakage)	All except A9	V _I = 0 V to 5.5 V		μA
		A9	V _I = 0 V to 13 V		
I _O	Output current (leakage)	V _O = 0 V to V _{CC}	±10		μA
I _{PP1}	V _{PP} supply current (read/standby)	V _{PP} = V _{PPH} , Read mode	200		μA
		V _{PP} = V _{PPL}	±10		
I _{PP2}	V _{PP} supply current (during program pulse)	V _{PP} = V _{PPH}	30		mA
I _{PP3}	V _{PP} supply current (during flash erase)	V _{PP} = V _{PPH}	30		mA
I _{PP4}	V _{PP} supply current (during program/erase-verify) (see Note 4)	V _{PP} = V _{PPH}	5.0		mA
I _{CCS}	V _{CC} supply current (standby)	TTL-input level	V _{CC} = 5.5 V, \bar{E} = V _{IH}		mA
		CMOS-input level	V _{CC} = 5.5 V, \bar{E} = V _{CC}		
I _{CC1}	V _{CC} supply current (active read)	V _{CC} = 5.5 V f = 6 MHz, I _{OUT} = 0 mA	30		mA
I _{CC2}	V _{CC} average supply current (active write) (see Note 4)	V _{CC} = 5.5 V, Programming in progress	10		mA
I _{CC3}	V _{CC} average supply current (flash erase) (see Note 4)	V _{CC} = 5.5 V, Erasure in progress	15		mA
I _{CC4}	V _{CC} average supply current (program/erase-verify) (see Note 4)	V _{CC} = 5.5 V, V _{PP} = V _{PPH} , Program/erase-verify in progress	15		mA
V _{LKO}	V _{CC} erase/write-lockout voltage	V _{PP} = V _{PPH}	2.5		V

NOTE 4: Characterization data available.

capacitance over recommended ranges of supply voltage and operating free-air temperature, f = 1 MHz†

PARAMETER		TEST CONDITIONS	MIN	MAX	UNIT
C _i	Input capacitance	V _I = 0 V, f = 1 MHz	6		pF
C _O	Output capacitance	V _O = 0 V, f = 1 MHz	12		pF

† Capacitance measurements are made on sample basis only.



switching characteristics over recommended ranges of supply voltage and operating free-air temperature

PARAMETER	TEST CONDITIONS	ALTERNATE SYMBOL	'28F010B-90		'28F010B-10		'28F010B-12		'28F010B-15		UNIT
			MIN	MAX	MIN	MAX	MIN	MAX	MIN	MAX	
t _a (A)	Access time from address, A0–A16	t _{AVQV}		90		100		120		150	ns
t _a (E)	Access time from chip enable, \overline{E}	t _{ELQV}		90		100		120		150	ns
t _{en} (G)	Access time from output enable, \overline{G}	t _{GLQV}		35		45		50		55	ns
t _c (R)	Cycle time, read	t _{AVAV}	90		100		120		150		ns
t _d (E)	Delay time, \overline{E} low to low-Z output	t _{ELQX}	0		0		0		0		ns
t _d (G)	Delay time, \overline{G} low to low-Z output	t _{GLQX}	0		0		0		0		ns
t _{dis} (E)	Chip disable time to Hi-Z output	t _{EHQZ}	0	45	0	55	0	55	0	55	ns
t _{dis} (G)	Output disable time to Hi-Z output	t _{GHQZ}	0	30	0	30	0	30	0	35	ns
t _h (D)	Hold time, data valid from address, \overline{E} or \overline{G} †	t _{AXQX}	0		0		0		0		ns
t _{rec} (W)	Write recovery time before read	t _{WHGL}	6		6		6		6		μs

† Whichever occurs first

TMS28F010B
131072 BY 8-BIT
FLASH MEMORY

SMJS824B – MAY 1995 – REVISED AUGUST 1997

timing requirements—write/erase/program operations

PARAMETER	ALTERNATE SYMBOL	'28F010B-90			'28F010B-10			UNIT
		MIN	NOM	MAX	MIN	NOM	MAX	
t _c (W)	Cycle time, write using \overline{W}	t _{AVAV}	90			100		ns
t _c (W)PR	Cycle time, programming operation	t _{WHWH1}	10			10		μs
t _c (W)ER	Cycle time, erase operation	t _{WHWH2}	9.5		10			ms
t _h (A)	Hold time, address	t _{WLAX}	40			55		ns
t _h (E)	Hold time, \overline{E}	t _{WHEH}	0			0		ns
t _h (WHD)	Hold time, data valid after \overline{W} high	t _{WHDX}	10			10		ns
t _{su} (A)	Setup time, address	t _{AVWL}	0			0		ns
t _{su} (D)	Setup time, data	t _{DVWH}	40			50		ns
t _{su} (E)	Setup time, \overline{E} before \overline{W}	t _{ELWL}	15			20		ns
t _{su} (VPPEL)	Setup time, V _{pp} to \overline{E} going low	t _{VPEL}	1			1		μs
t _{rec} (W)	Recovery time, \overline{W} before read	t _{WHGL}	6			6		μs
t _{rec} (R)	Recovery time, read before \overline{W}	t _{GHWL}	0			0		μs
t _w (W)	Pulse duration, \overline{W} (see Note 5)	t _{WLWH}	40			60		ns
t _w (WH)	Pulse duration, \overline{W} high	t _{WHWL}	20			20		ns
t _r (VPP)	Rise time, V _{pp}	t _{VPPR}	1			1		μs
t _f (VPP)	Fall time, V _{pp}	t _{VPPF}	1			1		μs

PARAMETER	ALTERNATE SYMBOL	'28F010B-12			'28F010B-15			UNIT
		MIN	NOM	MAX	MIN	NOM	MAX	
t _c (W)	Cycle time, write using \overline{W}	t _{AVAV}	120			150		ns
t _c (W)PR	Cycle time, programming operation	t _{WHWH1}	10			10		μs
t _c (W)ER	Cycle time, erase operation	t _{WHWH2}	9.5	10		9.5	10	ms
t _h (A)	Hold time, address	t _{WLAX}	60			60		ns
t _h (E)	Hold time, \overline{E}	t _{WHEH}	0			0		ns
t _h (WHD)	Hold time, data valid after \overline{W} high	t _{WHDX}	10			10		ns
t _{su} (A)	Setup time, address	t _{AVWL}	0			0		ns
t _{su} (D)	Setup time, data	t _{DVWH}	50			50		ns
t _{su} (E)	Setup time, \overline{E} before \overline{W}	t _{ELWL}	20			20		ns
t _{su} (VPPEL)	Setup time, V _{pp} to \overline{E} low	t _{VPEL}	1			1		μs
t _{rec} (W)	Recovery time, \overline{W} before read	t _{WHGL}	6			6		μs
t _{rec} (R)	Recovery time, read before \overline{W}	t _{GHWL}	0			0		μs
t _w (W)	Pulse duration, \overline{W} (see Note 5)	t _{WLWH}	60			60		ns
t _w (WH)	Pulse duration, \overline{W} high	t _{WHWL}	20			20		ns
t _r (VPP)	Rise time, V _{pp}	t _{VPPR}	1			1		μs
t _f (VPP)	Fall time, V _{pp}	t _{VPPF}	1			1		μs

NOTE 5: Rise/fall time ≤ 10 ns



timing requirements — alternative \overline{E} -controlled writes

PARAMETER	ALTERNATE SYMBOL	'28F010B-90		'28F010B-10		'28F010B-12		'28F010B-15		UNIT	
		MIN	MAX	MIN	MAX	MIN	MAX	MIN	MAX		
$t_{c(W)}$	Cycle time, write using \overline{E}			90		100		120		150	ns
$t_{c(E)PR}$	Cycle time, programming operation			10		10		10		10	μ s
$t_{h(EA)}$	Hold time, address			45		75		80		80	ns
$t_{h(ED)}$	Hold time, data			10		10		10		10	ns
$t_{h(W)}$	Hold time, \overline{W}			0		0		0		0	ns
$t_{su(A)}$	Setup time, address			0		0		0		0	ns
$t_{su(D)}$	Setup time, data			35		50		50		50	ns
$t_{su(W)}$	Setup time, \overline{W} before \overline{E}			0		0		0		0	ns
$t_{su(VPPEL)}$	Setup time, V_{PP} to \overline{E} low			1		1		1		1	μ s
$t_{rec(E)R}$	Recovery time, write using \overline{E} before read			6		6		6		6	μ s
$t_{rec(E)W}$	Recovery time, read before write using \overline{E}			0		0		0		0	μ s
$t_{w(E)}$	Pulse duration, write using \overline{E}			45		70		70		70	ns
$t_{w(EH)}$	Pulse duration, write, \overline{E} high			20		20		20		20	ns

PARAMETER MEASUREMENT INFORMATION

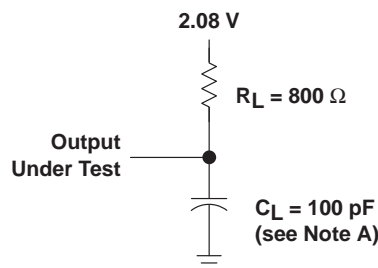

NOTE A: C_L includes probe and fixture capacitance.

Figure 4. AC Test Output Load Circuit

AC testing input/output waveforms

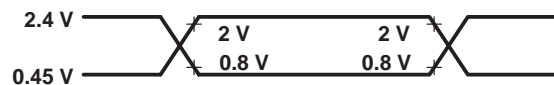

AC testing inputs are driven at 2.4 V for logic high and 0.45 V for logic low. Timing measurements are made at 2 V for logic high and 0.8 V for logic low on both inputs and outputs. Each device should have a 0.1- μ F ceramic capacitor connected between V_{CC} and V_{SS} as close as possible to the device pins.

PARAMETER MEASUREMENT INFORMATION

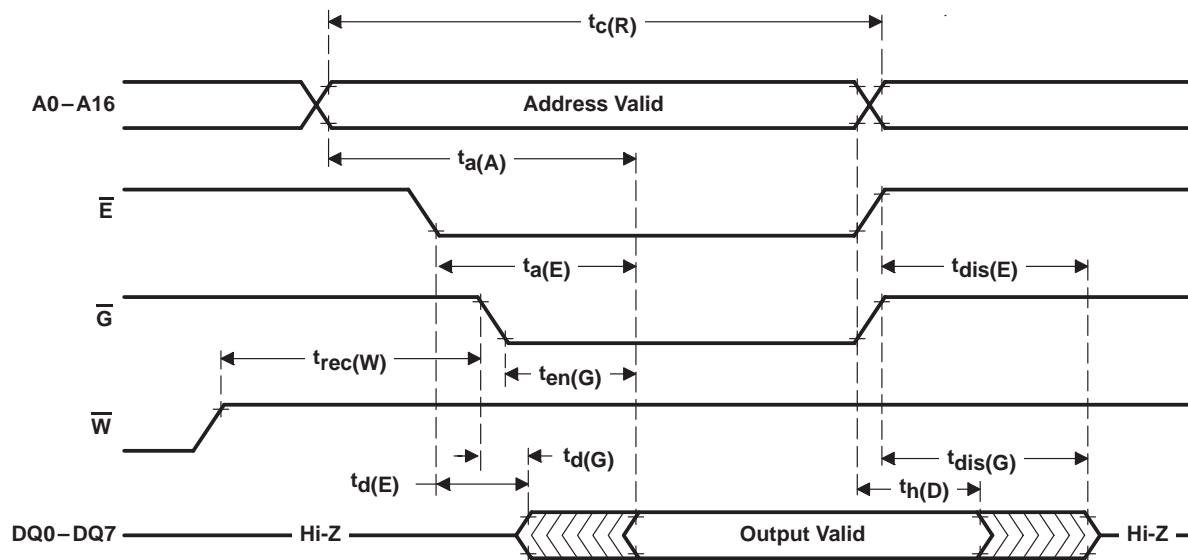

Figure 5. Read-Cycle Timing

PARAMETER MEASUREMENT INFORMATION

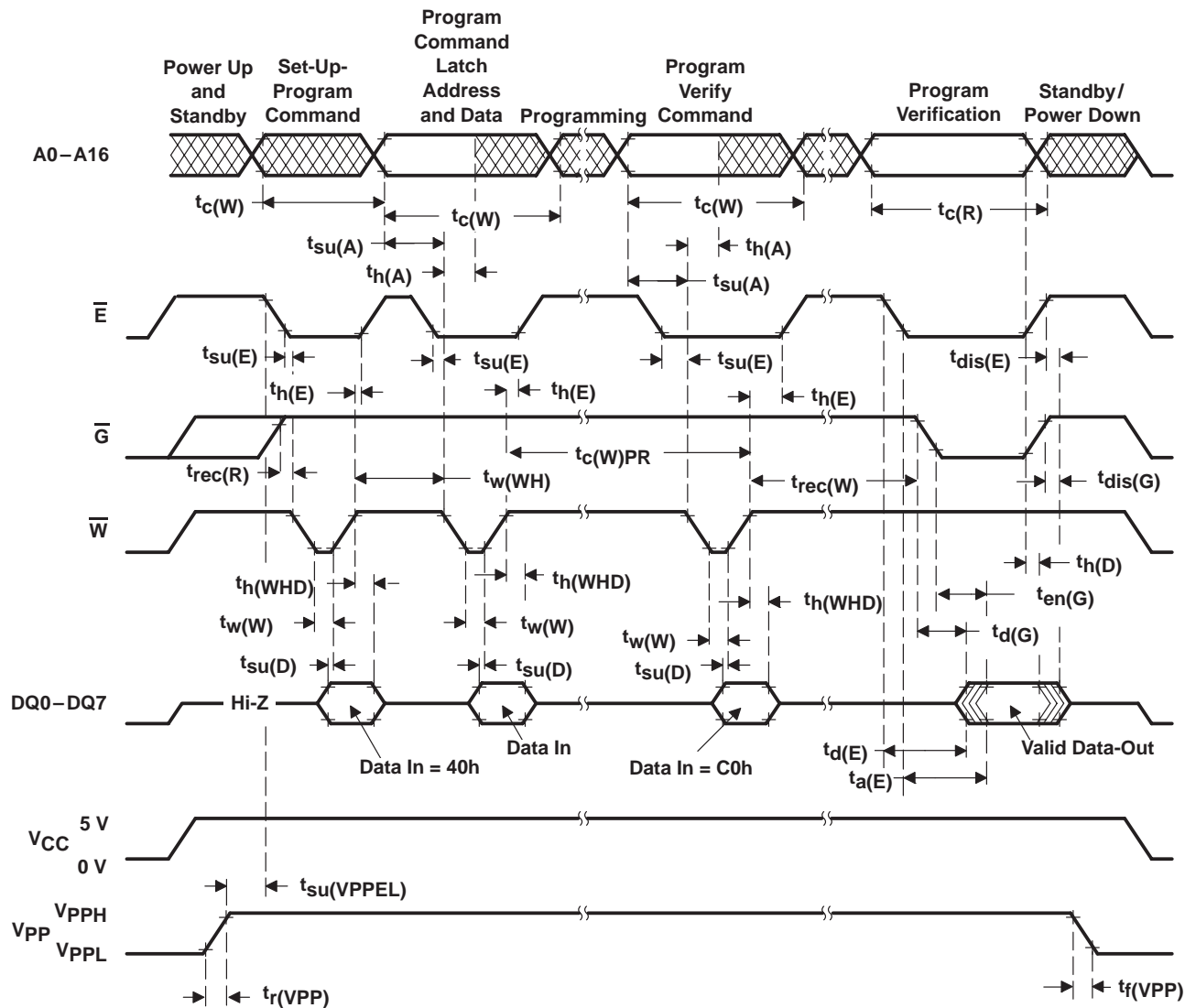

Figure 6. Write-Cycle Timing

PARAMETER MEASUREMENT INFORMATION

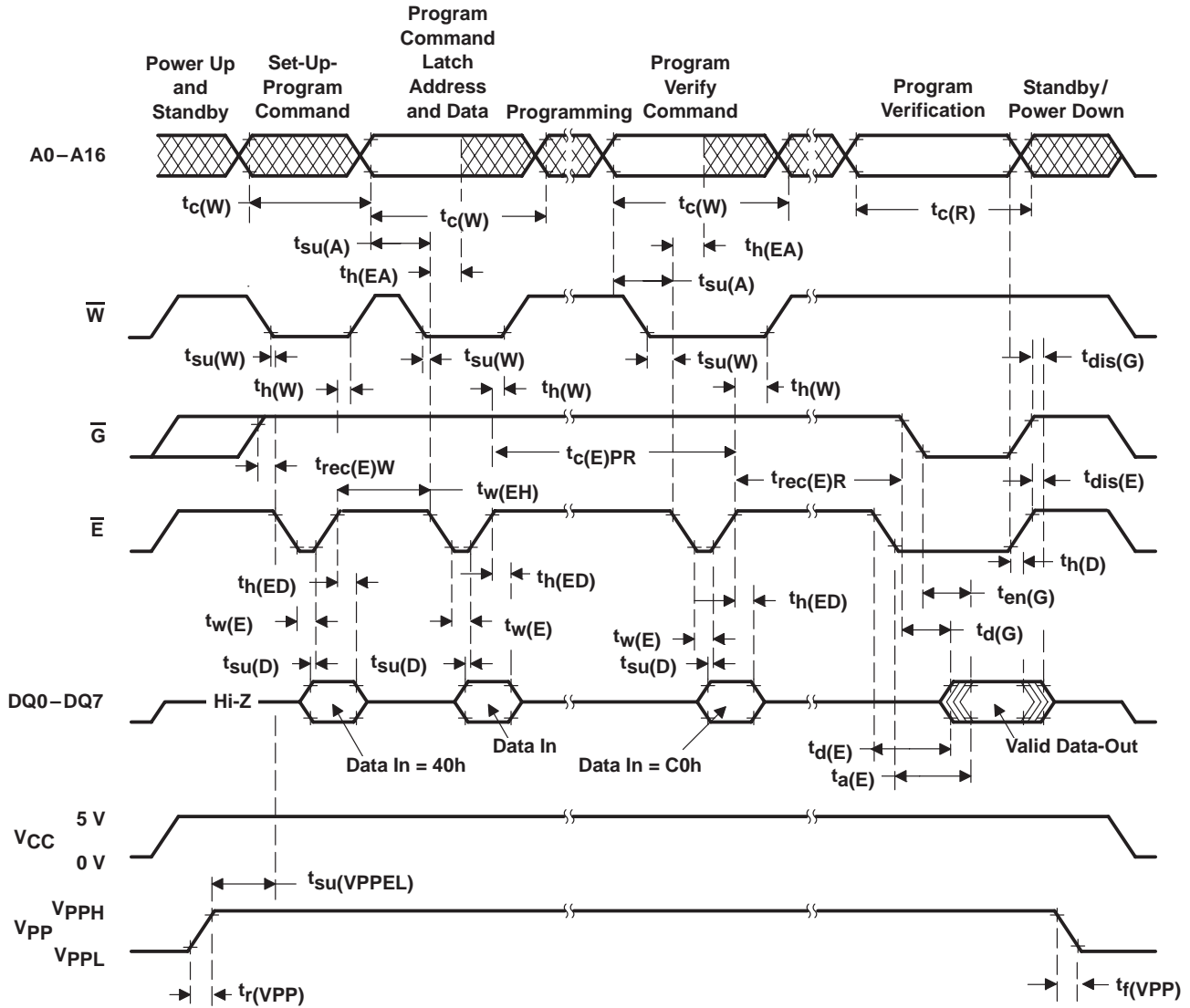

Figure 7. Write-Cycle (Alternative \bar{E} -Controlled Writes) Timing

PARAMETER MEASUREMENT INFORMATION

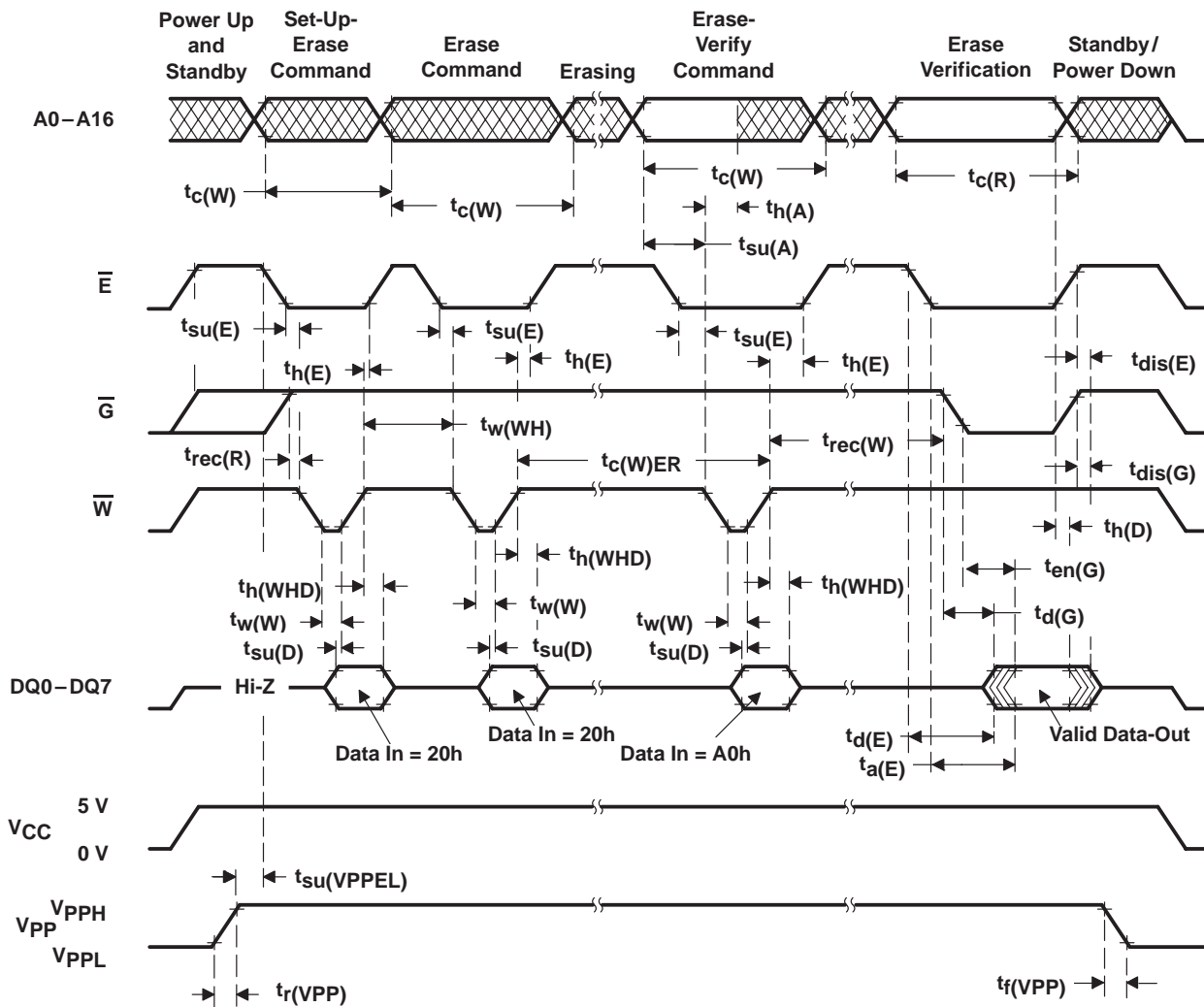

Figure 8. Flash-Erase-Cycle Timing

TMS28F010B
131072 BY 8-BIT
FLASH MEMORY

SMJS824B – MAY 1995 – REVISED AUGUST 1997



IMPORTANT NOTICE

Texas Instruments and its subsidiaries (TI) reserve the right to make changes to their products or to discontinue any product or service without notice, and advise customers to obtain the latest version of relevant information to verify, before placing orders, that information being relied on is current and complete. All products are sold subject to the terms and conditions of sale supplied at the time of order acknowledgement, including those pertaining to warranty, patent infringement, and limitation of liability.

TI warrants performance of its semiconductor products to the specifications applicable at the time of sale in accordance with TI's standard warranty. Testing and other quality control techniques are utilized to the extent TI deems necessary to support this warranty. Specific testing of all parameters of each device is not necessarily performed, except those mandated by government requirements.

CERTAIN APPLICATIONS USING SEMICONDUCTOR PRODUCTS MAY INVOLVE POTENTIAL RISKS OF DEATH, PERSONAL INJURY, OR SEVERE PROPERTY OR ENVIRONMENTAL DAMAGE ("CRITICAL APPLICATIONS"). TI SEMICONDUCTOR PRODUCTS ARE NOT DESIGNED, AUTHORIZED, OR WARRANTED TO BE SUITABLE FOR USE IN LIFE-SUPPORT DEVICES OR SYSTEMS OR OTHER CRITICAL APPLICATIONS. INCLUSION OF TI PRODUCTS IN SUCH APPLICATIONS IS UNDERSTOOD TO BE FULLY AT THE CUSTOMER'S RISK.

In order to minimize risks associated with the customer's applications, adequate design and operating safeguards must be provided by the customer to minimize inherent or procedural hazards.

TI assumes no liability for applications assistance or customer product design. TI does not warrant or represent that any license, either express or implied, is granted under any patent right, copyright, mask work right, or other intellectual property right of TI covering or relating to any combination, machine, or process in which such semiconductor products or services might be or are used. TI's publication of information regarding any third party's products or services does not constitute TI's approval, warranty or endorsement thereof.