

Features

- Low gate charge
- 100% avalanche tested
- Improved dv/dt capability
- RoHS compliant
- Halogen free package
- JEDEC Qualification
- Improved ESD performance

N-channel MOSFET

BV_{DSS}	I_D	$R_{DS(on)}$
650V	4.0A	< 2.4 Ω

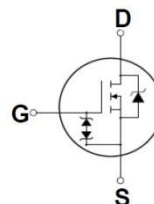
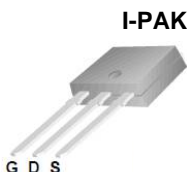

Device	Package	Marking	Remark
TMD4N65AZ / TMU4N65AZ	D-PAK/I-PAK	TMD4N65AZ / TMU4N65AZ	RoHS
TMD4N65AZG / TMU4N65AZG	D-PAK/I-PAK	TMD4N65AZG / TMU4N65AZG	Halogen Free

Absolute Maximum Ratings

Parameter	Symbol	TMD4N65AZ(G)/TMU4N65AZ(G)	Unit
Drain-Source Voltage	V_{DSS}	650	V
Gate-Source Voltage	V_{GS}	± 30	V
Continuous Drain Current	I_D	$T_C = 25\text{ }^\circ\text{C}$	4
		$T_C = 100\text{ }^\circ\text{C}$	2.63
Pulsed Drain Current (Note 1)	I_{DM}	16	A
Single Pulse Avalanche Energy (Note 2)	E_{AS}	206	mJ
Repetitive Avalanche Current (Note 1)	I_{AR}	4	A
Repetitive Avalanche Energy (Note 1)	E_{AR}	9.84	mJ
Power Dissipation	P_D	$T_C = 25\text{ }^\circ\text{C}$	98.4
		Derate above 25 $^\circ\text{C}$	0.78
Peak Diode Recovery dv/dt (Note 3)	dv/dt	4.5	V/ns
Operating Junction and Storage Temperature Range	T_J, T_{STG}	-55~150	$^\circ\text{C}$
Maximum lead temperature for soldering purposes, 1/8" from case for 5 seconds	T_L	300	$^\circ\text{C}$

* Limited only by maximum junction temperature

Thermal Characteristics

Parameter	Symbol	TMD4N65AZ(G)/TMU4N65AZ(G)	Unit
Maximum Thermal resistance, Junction-to-Case	$R_{\theta JC}$	1.27	$^\circ\text{C}/\text{W}$
Maximum Thermal resistance, Junction-to-Ambient	$R_{\theta JA}$	110	$^\circ\text{C}/\text{W}$

Electrical Characteristics : $T_C=25^\circ\text{C}$, unless otherwise noted

Parameter	Symbol	Test condition	Min	Typ	Max	Units
OFF						
Drain-Source Breakdown Voltage	BV_{DSS}	$V_{GS} = 0\text{ V}, I_D = 250\ \mu\text{A}$	650	--	--	V
Zero Gate Voltage Drain Current	I_{DSS}	$V_{DS} = 650\text{ V}, V_{GS} = 0\text{ V}$	--	--	1	μA
		$V_{DS} = 520\text{ V}, T_C = 125^\circ\text{C}$	--	--	10	μA
Forward Gate-Source Leakage Current	I_{GSSF}	$V_{GS} = 30\text{ V}, V_{DS} = 0\text{ V}$	--	--	100	μA
Reverse Gate-Source Leakage Current	I_{GSSR}	$V_{GS} = -30\text{ V}, V_{DS} = 0\text{ V}$	--	--	-100	μA

ON

Gate Threshold Voltage	$V_{GS(th)}$	$V_{DS} = V_{GS}, I_D = 250\ \mu\text{A}$	3	--	5	V
Drain-Source On-Resistance	$R_{DS(on)}$	$V_{GS} = 10\text{ V}, I_D = 2.0\text{ A}$	--	2.0	2.4	Ω
Forward Transconductance ^(Note 4)	g_{FS}	$V_{DS} = 30\text{ V}, I_D = 2.0\text{ A}$	--	6.5	--	S

DYNAMIC

Input Capacitance	C_{iss}	$V_{DS} = 25\text{ V}, V_{GS} = 0\text{ V},$ $f = 1.0\text{ MHz}$	--	642	--	pF
Output Capacitance	C_{oss}		--	67	--	pF
Reverse Transfer Capacitance	C_{rss}		--	9.6	--	pF

SWITCHING

Turn-On Delay Time ^(Note 4,5)	$t_{d(on)}$	$V_{DD} = 325\text{ V}, I_D = 4.0\text{ A},$ $R_G = 25\ \Omega$	--	19	--	ns
Turn-On Rise Time ^(Note 4,5)	t_r		--	22	--	ns
Turn-Off Delay Time ^(Note 4,5)	$t_{d(off)}$		--	50	--	ns
Turn-Off Fall Time ^(Note 4,5)	t_f		--	18	--	ns
Total Gate Charge ^(Note 4,5)	Q_g	$V_{DS} = 520\text{ V}, I_D = 4.0\text{ A},$ $V_{GS} = 10\text{ V}$	--	15	--	nC
Gate-Source Charge ^(Note 4,5)	Q_{gs}		--	3	--	nC
Gate-Drain Charge ^(Note 4,5)	Q_{gd}		--	7	--	nC

SOURCE DRAIN DIODE

Maximum Continuous Drain-Source Diode Forward Current	I_S	----	--	--	4	A
Maximum Pulsed Drain-Source Diode Forward Current	I_{SM}	----	--	--	16	A
Drain-Source Diode Forward Voltage	V_{SD}	$V_{GS} = 0\text{ V}, I_S = 4.0\text{ A}$	--	--	1.5	V
Reverse Recovery Time ^(Note 4)	t_{rr}	$V_{GS} = 0\text{ V}, I_S = 4.0\text{ A}$	--	328	--	ns
Reverse Recovery Charge ^(Note 4)	Q_{rr}	$di_F / dt = 100\text{ A}/\mu\text{s}$	--	1.7	--	μC

Note :

1. Repeated rating : Pulse width limited by safe operating area
2. $L=23.8\text{mH}, I_{AS} = 4.0\text{A}, V_{DD} = 50\text{V}, R_G = 25\Omega,$ Starting $T_J = 25^\circ\text{C}$
3. $I_{SD} \leq 4.0\text{A}, di/dt \leq 200\text{A}/\mu\text{s}, V_{DD} \leq BV_{DS},$ Starting $T_J = 25^\circ\text{C}$
4. Pulse Test : Pulse width $\leq 300\mu\text{s},$ Duty Cycle $\leq 2\%$
5. Essentially Independent of Operating Temperature Typical Characteristics

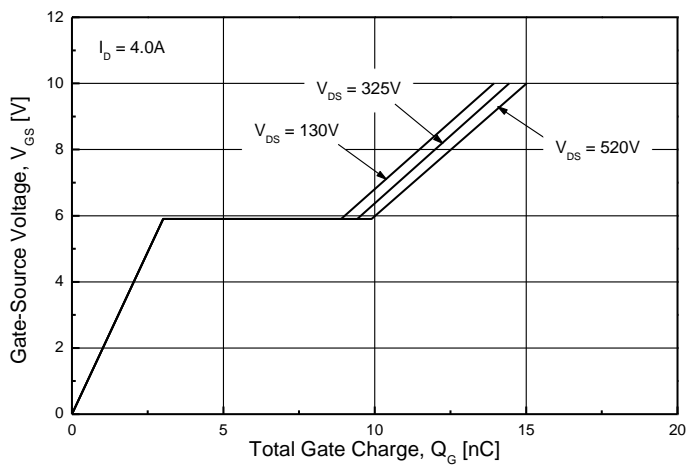
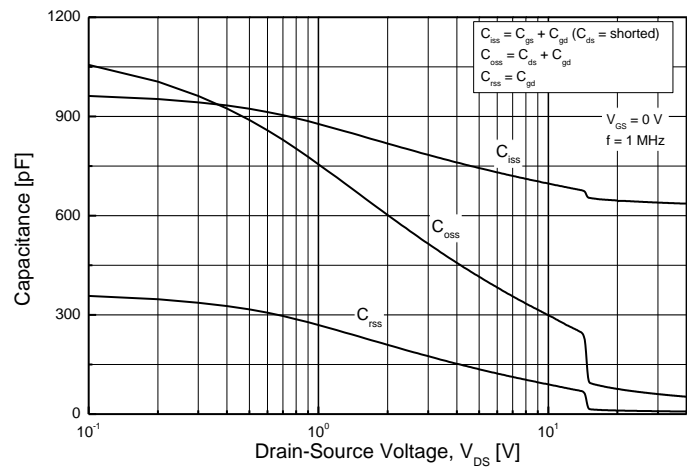
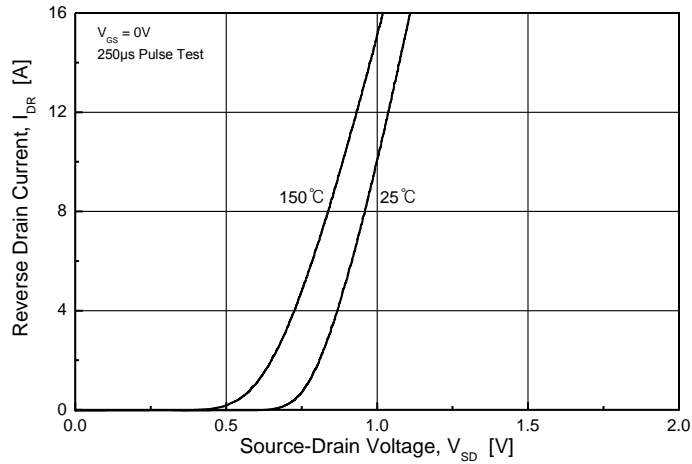
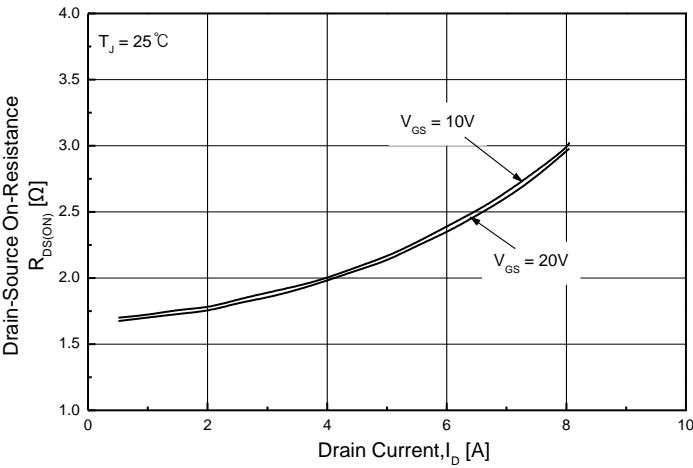
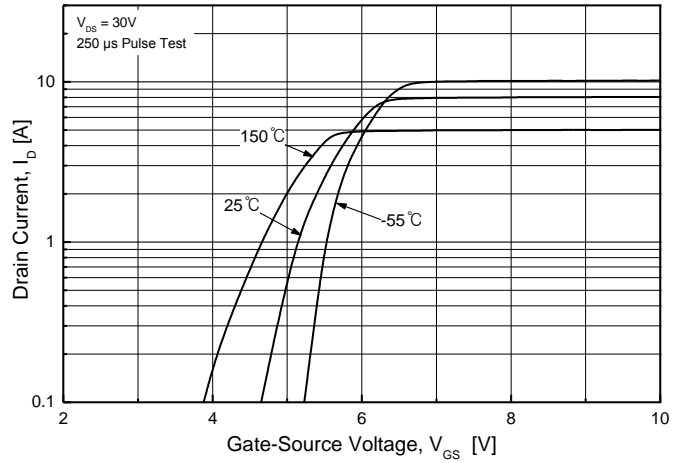
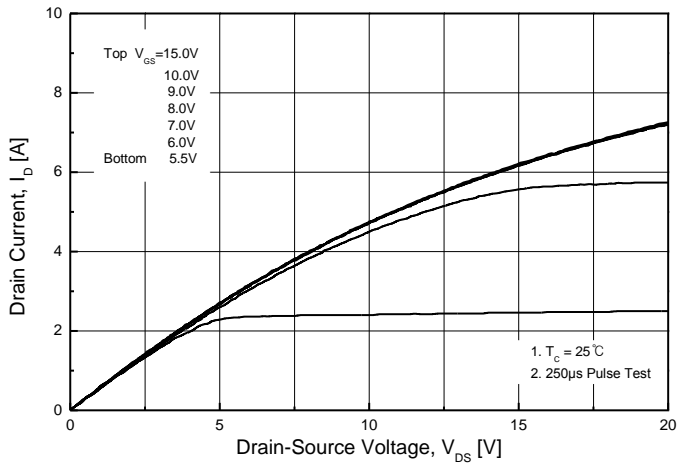

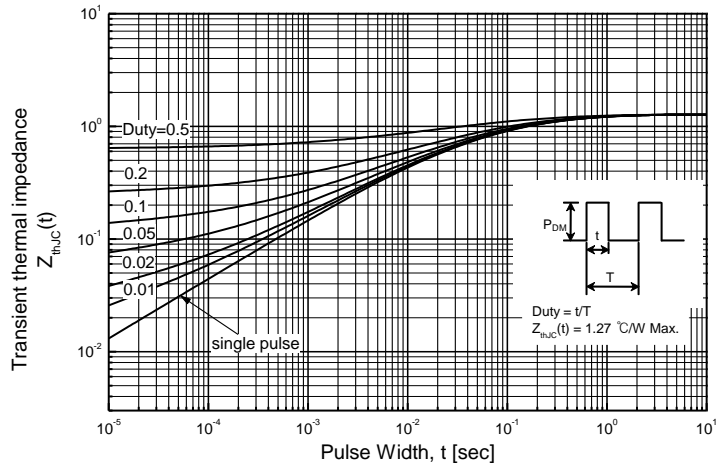
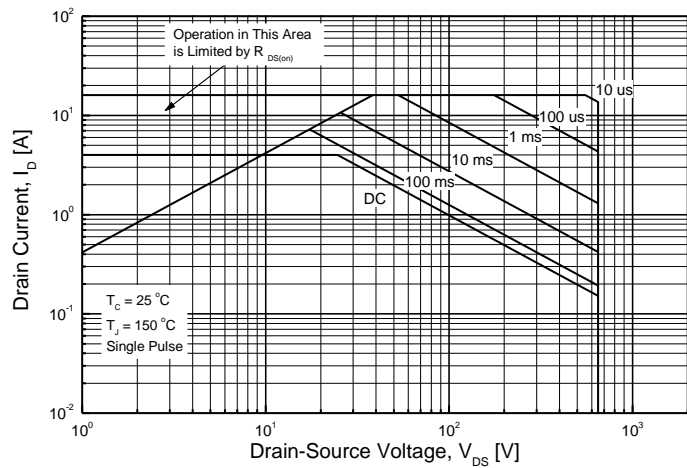
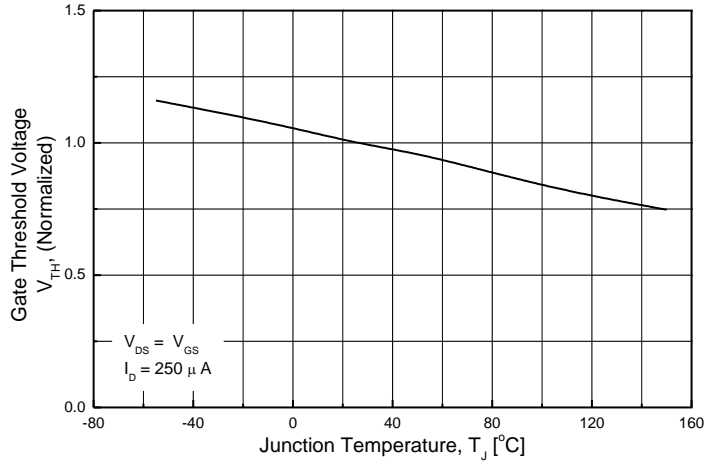
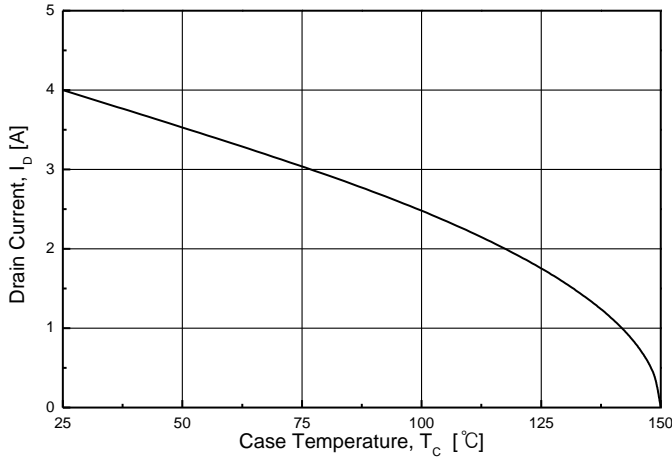
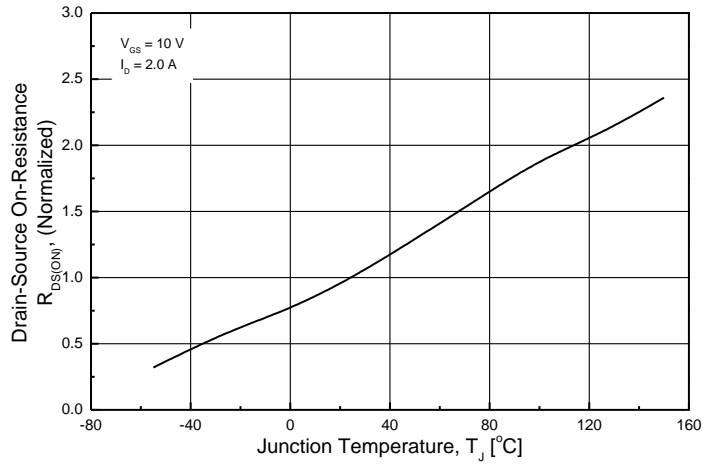
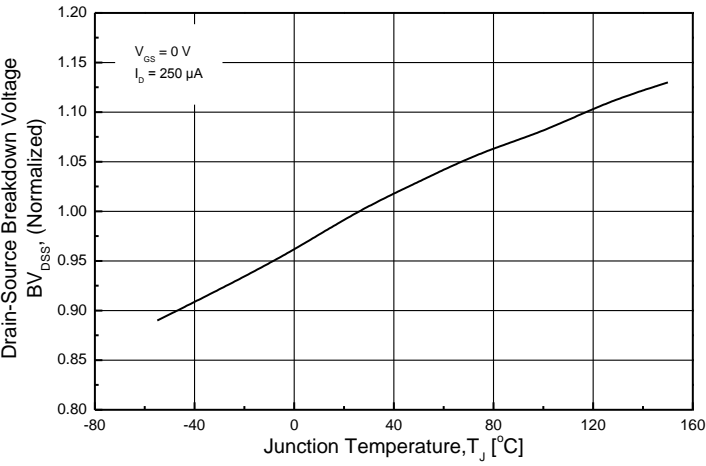

TO-252 (D-PAK) MECHANICAL DATA

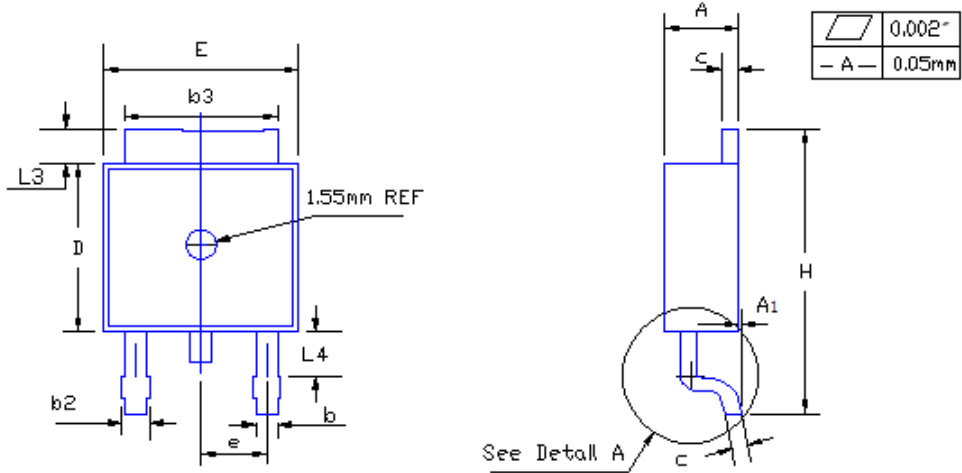

SYMBOL	MILLIMETERS	
	MIN	MAX
A	2.19	2.38
A1	—	0.13
b	0.64	0.89
b2	0.84	1.14
b3	5.21	5.46
c	0.46	0.61
D	5.97	6.22
D1	5.21	—
E	6.35	6.73
E1	4.83	—
e	2.29BSC	
H	9.65	10.41
L	1.40	1.78
L2	0.51BSC	
L3	0.89	1.27
L4	0.64	1.01
Ø	0	8

TO-251 (I-PAK) MECHANICAL DATA



SYMBOL	MILLIMETERS	
	MIN	MAX
A	2.19	2.38
A1	1.04	1.23
b	0.64	0.89
b1	0.84	1.14
b2	5.23	5.48
c	0.46	0.61
D	5.91	6.28
E	6.21	6.59
e	2.28 TYP	
L	8.89	9.65
L2	0.89	1.27