

High temperature 16 A SCRs

Datasheet - production data

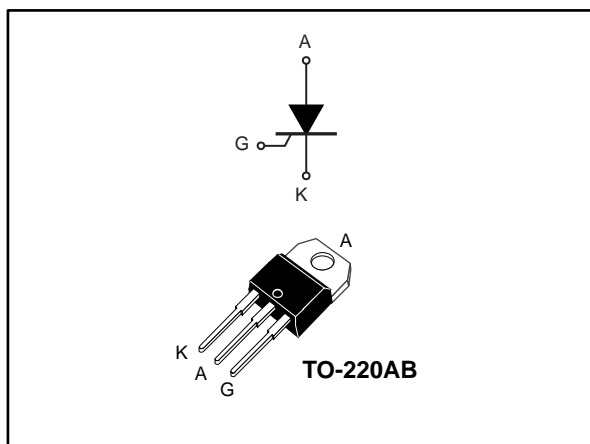

Features

- High junction temperature: $T_j = 150\text{ °C}$
- Gate triggering current $I_{GT} = 6\text{ mA}$
- High noise immunity $dV/dt = 200\text{ V}/\mu\text{s}$ up to 150 °C
- Blocking voltage $V_{DRM}/V_{RRM} = 600\text{ V}$
- High turn-on current rise $dI/dt: 100\text{ A}/\mu\text{s}$
- ECOPACK[®]2 compliant component

Applications

- Motorbikes voltage regulator circuits
- Inrush current limiting circuits
- Motor control circuits and starters
- Light dimmers
- Solid state relays

Description

Designed with high immunity switching to external surges, the device offers robust switching up to its 150 °C maximum T_j .

The combination of noise immunity and low gate triggering current allows to design strong and compact control circuit.

Table 1: Device summary

Order code	Package	V_{DRM}/V_{RRM}	I_{GT}
TN1605H-6T	TO-220AB	600	6 mA

1 Characteristics

Table 2: Absolute maximum ratings (limiting values, $T_j = 25\text{ °C}$ unless otherwise specified)

Symbol	Parameter		Value	Unit
$I_{T(RMS)}$	RMS on-state current (180° conduction angle)		$T_c = 133\text{ °C}$	16 A
$I_{T(AV)}$	Average on-state current (180° conduction angle)		$T_c = 133\text{ °C}$	10
			$T_c = 138\text{ °C}$	8
			$T_c = 142\text{ °C}$	6
I_{TSM}	Non repetitive surge peak on-state current	$t_p = 8.3\text{ ms}$	$T_j\text{ initial} = 25\text{ °C}$	153
		$t_p = 10\text{ ms}$		140
I^2t	I^2t value for fusing	$t_p = 10\text{ ms}$		98 A ² s
di/dt	Critical rate of rise of on-state current	$I_G = 2 \times I_{GT}$, $t_r \leq 100\text{ ns}$,	$f = 60\text{ Hz}$	100 A/ μ s
V_{DRM}/V_{RRM}	Repetitive peak off-state voltage		$T_j = 150\text{ °C}$	600 V
V_{DSM}/V_{RSM}	Non repetitive surge peak off-state voltage	$t_p = 10\text{ ms}$		700 V
$P_G(AV)$	Average gate power dissipation		$T_j = 150\text{ °C}$	1 W
V_{RGM}	Maximum peak reverse gate voltage			5 V
I_{GM}	Peak gate current	$t_p = 20\text{ }\mu$ s	$T_j = 150\text{ °C}$	4 A
P_{GM}	Peak gate power dissipation	$t_p = 20\text{ }\mu$ s	$T_j = 150\text{ °C}$	40 W
$P_G(AV)$	Average gate power dissipation		$T_j = 150\text{ °C}$	1 W
T_{stg}	Storage junction temperature range			-40 to +150 °C
T_j	Operating junction temperature range			-40 to +150 °C
T_L	Maximum lead temperature for soldering during 10 s			260 °C

Table 3: Dynamic characteristics

Symbol	Parameter	T_j		Value	Unit
I_{GT}	$V_D = 12\text{ V}$, $R_L = 33\text{ }\Omega$	25 °C	Min.	3.5	mA
			Typ.	4.5	
			Max.	6	
V_{GT}			Max.	1.3	V
V_{GD}	$V_D = 600\text{ V}$, $R_L = 3.3\text{ k}\Omega$	150 °C	Min.	0.15	V
I_L	$I_G = 1.2 \times I_{GT}$	25 °C	Max.	40	mA
I_H	$I_T = 500\text{ mA}$, gate open		Max.	20	
dV/dt	$V_D = 402\text{ V}$, gate open	150 °C	Min.	200	V/ μ s
t_{gt}	$I_{TM} = 32\text{ A}$, $V_D = 402\text{ V}$, $I_G = 12\text{ mA}$, (dI_G/dt) max = 0.2 A/ μ s	25 °C	Typ.	1.9	μ s
t_q	$I_{TM} = 32\text{ A}$, $V_D = 402\text{ V}$, (dI/dt) _{off} = 30 A/ μ s, $V_R = 25\text{ V}$, $dV_D/dt = 20\text{ V}/\mu$ s	150 °C	Typ.	70	μ s

Table 4: Static electrical characteristics

Symbol	Test Conditions	T _j		Value	Unit
V _{TM}	I _{TM} = 32 A, t _p = 380 μs	25 °C	Max.	1.6	V
V _{TO}	Threshold on-state voltage	150 °C	Max.	0.82	V
R _D	Dynamic resistance	150 °C	Max.	25	mΩ
I _{DRM} /I _{RPM}	V _{DRM} = V _{RPM}	25 °C	Max.	5	μA
		125 °C		1.5	mA
		150 °C		3.1	

Table 5: Thermal resistance

Symbol	Parameter	Value	Unit
R _{th(j-c)}	Junction to case (DC)	1.1	°C/W
R _{th(j-a)}	Junction to ambient (DC)	60	

1.1 Characteristics (curves)

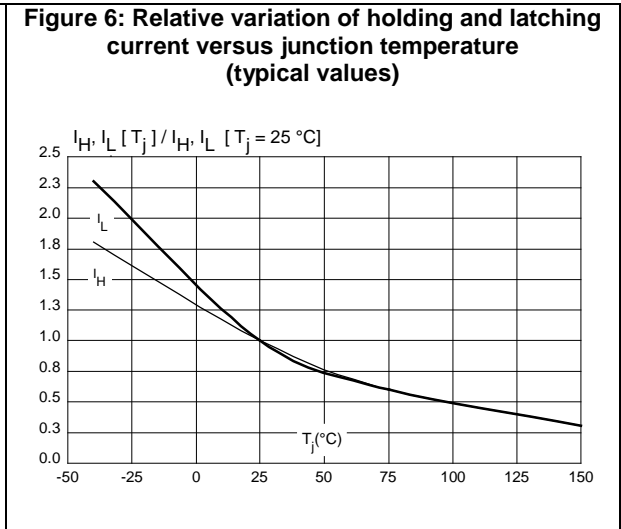
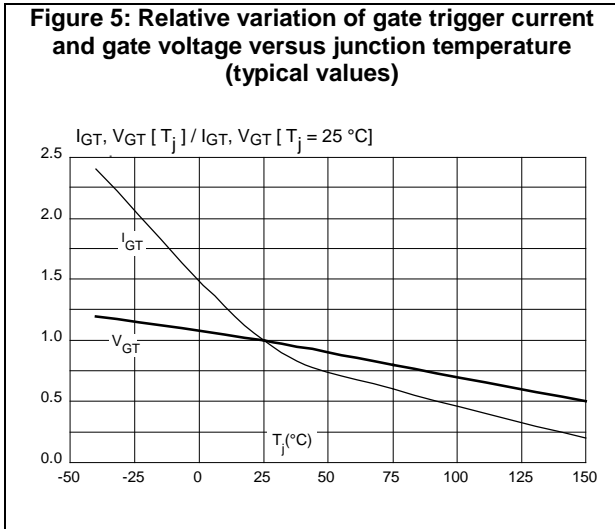
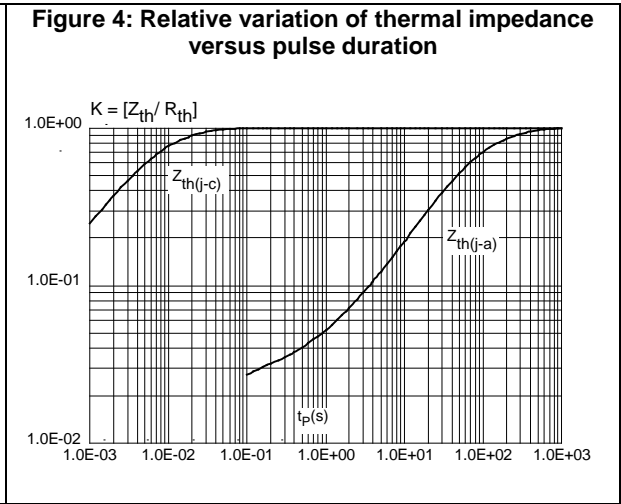
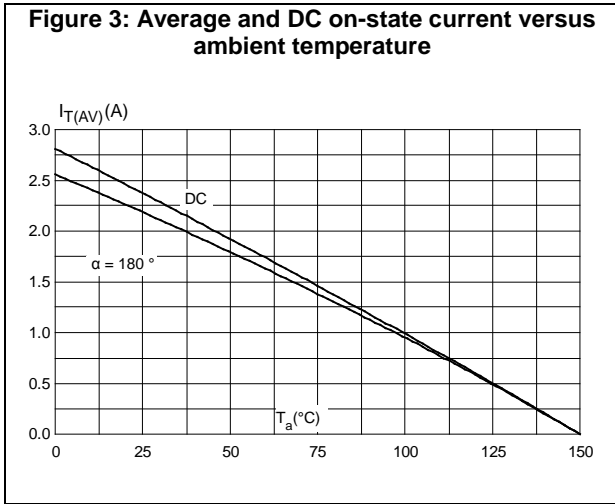
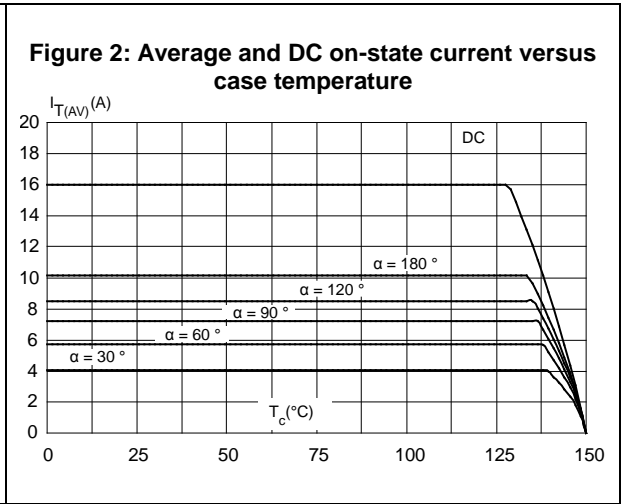
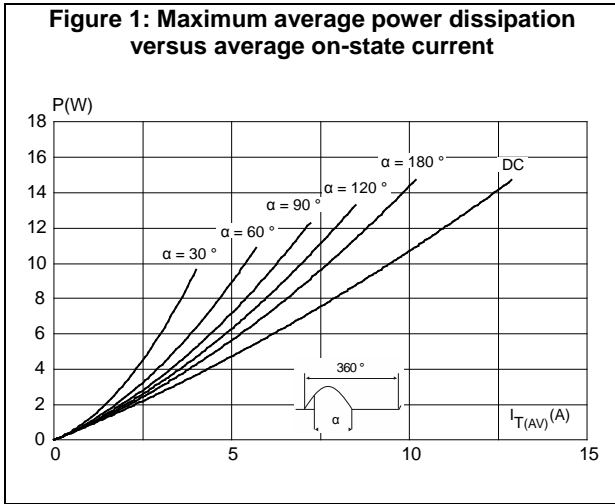

Figure 7: Relative variation of static dV/dt immunity versus junction temperature (typical values)

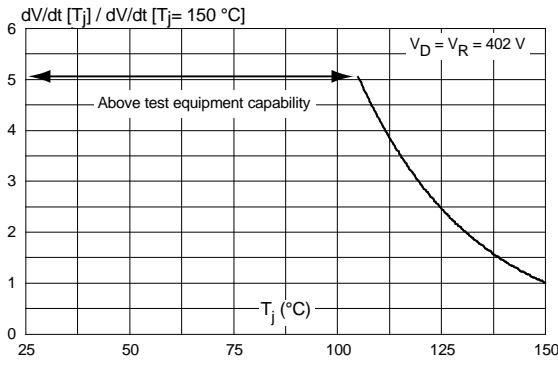

Figure 8: Surge peak on-state current versus number of cycles

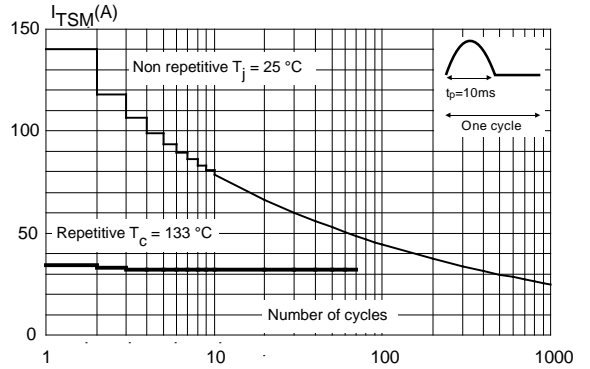

Figure 9: Non repetitive surge peak on-state current versus sinusoidal pulse width (tp < 10 ms).

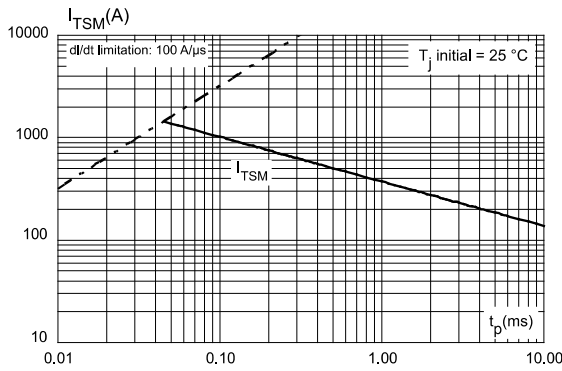

Figure 10: On-state characteristics (maximum values)

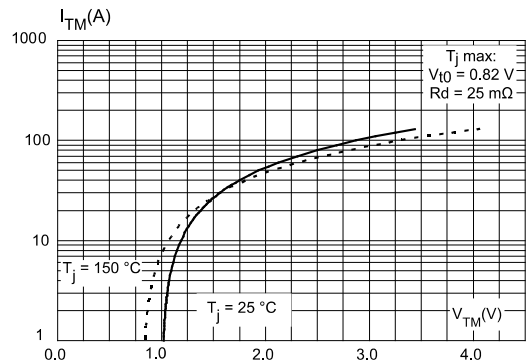
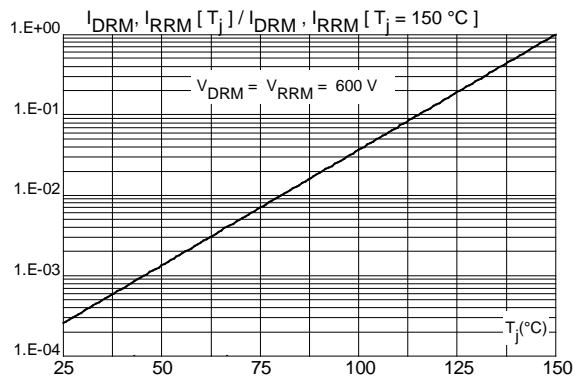

Figure 11: Relative variation of leakage current versus junction temperature (tp < 10ms)



2 Package information

In order to meet environmental requirements, ST offers these devices in different grades of ECOPACK® packages, depending on their level of environmental compliance. ECOPACK® specifications, grade definitions and product status are available at: www.st.com. ECOPACK® is an ST trademark.

- Epoxy meets UL 94,V0
- Lead-free package

2.1 TO-220AB (NIns. and Ins.) package information

Figure 12: TO-220AB (NIns. & Ins.) package outline

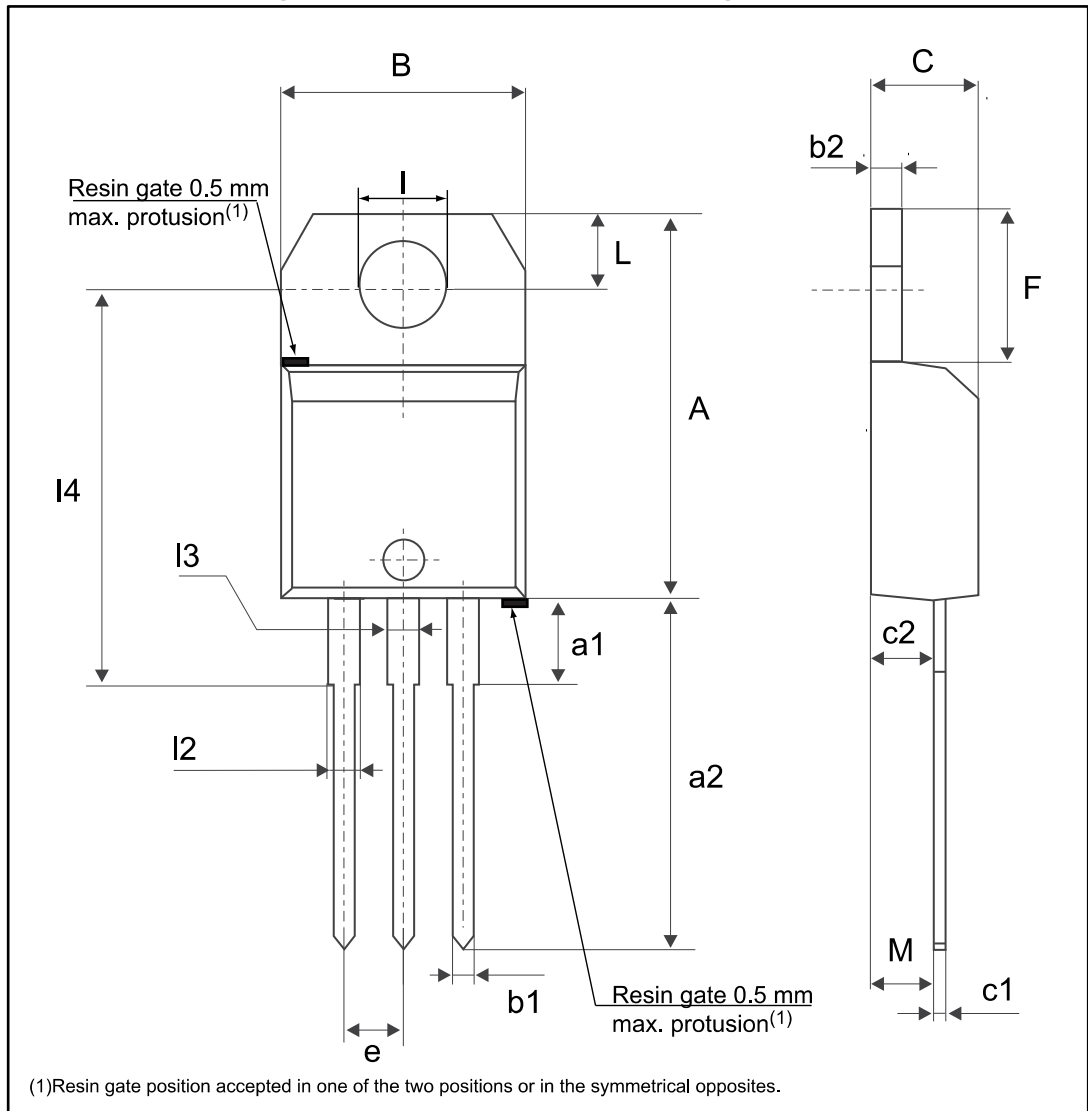

Table 6: TO-220AB (NIns. & Ins.) package mechanical data

Ref.	Dimensions					
	Millimeters			Inches ⁽¹⁾		
	Min.	Typ.	Max.	Min.	Typ.	Max.
A	15.20		15.90	0.5984		0.6260
a1		3.75			0.1476	
a2	13.00		14.00	0.5118		0.5512
B	10.00		10.40	0.3937		0.4094
b1	0.61		0.88	0.0240		0.0346
b2	1.23		1.32	0.0484		0.0520
C	4.40		4.60	0.1732		0.1811
c1	0.49		0.70	0.0193		0.0276
c2	2.40		2.72	0.0945		0.1071
e	2.40		2.70	0.0945		0.1063
F	6.20		6.60	0.2441		0.2598
I	3.73		3.88	0.1469		0.1528
L	2.65		2.95	0.1043		0.1161
I2	1.14		1.70	0.0449		0.0669
I3	1.14		1.70	0.0449		0.0669
I4	15.80	16.40	16.80	0.6220	0.6457	0.6614
M		2.6			0.1024	

Notes:

⁽¹⁾Inch dimensions are for reference only.

3 Ordering information

Figure 13: Ordering information scheme

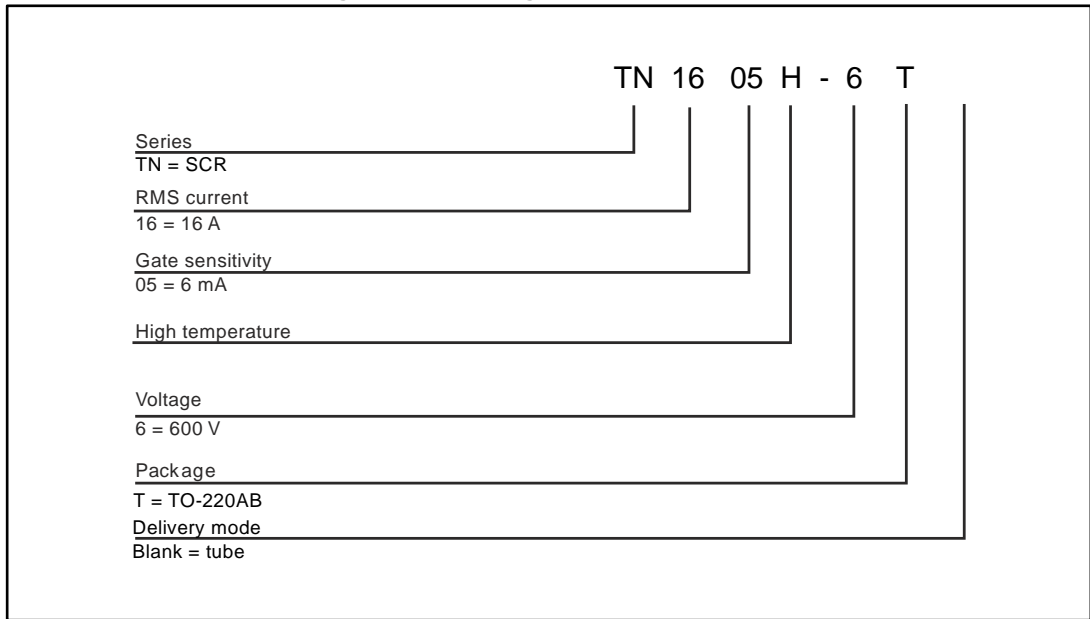

Table 7: Ordering information

Order code	Marking	Package	Weight	Base qty.	Delivery mode
TN1605H-6T	TN1605H6	TO-220AB	2.3 g	50	Tube

4 Revision history

Table 8: Document revision history

Date	Revision	Changes
19-May-2017	1	Initial release.

IMPORTANT NOTICE – PLEASE READ CAREFULLY

STMicroelectronics NV and its subsidiaries ("ST") reserve the right to make changes, corrections, enhancements, modifications, and improvements to ST products and/or to this document at any time without notice. Purchasers should obtain the latest relevant information on ST products before placing orders. ST products are sold pursuant to ST's terms and conditions of sale in place at the time of order acknowledgement.

Purchasers are solely responsible for the choice, selection, and use of ST products and ST assumes no liability for application assistance or the design of Purchasers' products.

No license, express or implied, to any intellectual property right is granted by ST herein.

Resale of ST products with provisions different from the information set forth herein shall void any warranty granted by ST for such product.

ST and the ST logo are trademarks of ST. All other product or service names are the property of their respective owners.

Information in this document supersedes and replaces information previously supplied in any prior versions of this document.

© 2017 STMicroelectronics – All rights reserved