

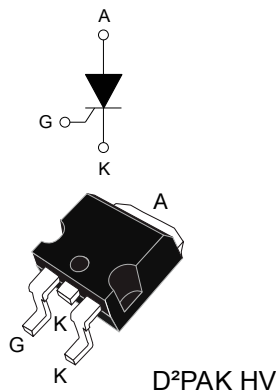

40 A 1200 V automotive grade thyristor (SCR)



Features

- AEC-Q101 qualified 
- High junction temperature: 150 °C
- AC off state voltage: +/- 1200 V
- Nominal on-state RMS current: 40 A_{RMS}
- High EFT noise immunity: 1000 V/μs
- Max. gate triggering current: 50 mA
- D²PAK HV creepage distance (anode to cathode):
 - With top coating: 5.38 mm min.
 - Without top coating: 3.48 mm min.
- ECOPACK2 compliant component

Application

- On board charger
- Capacitor discharge
- Overvoltage crowbar protection
- Power supplies
- AC switches
- Solid state relays

Product status

TN4050HP-12G2YTR

Product summary

$I_{T(RMS)}$	40 A
V_{DRM}/V_{RRM}	1200 V
V_{DSM}/V_{RSM}	1400 V
I_{GT}	50 mA
T_j	-40 to 150 °C

Description

The **TN4050HP-12G2YTR** is an automotive grade SCR thyristor designed for applications such as automotive on board and stationary battery chargers.

This SCR Thyristor, rated for a 40 A RMS power switching, offers superior performances in peak voltage robustness up to 400 V sine wave pulse. Its key features allow the design of functions such as a 56 A RMS AC switch and a 50 A AC-DC controlled rectifier-bridge.

The **TN4050HP-12G2YTR** is available in D²PAK HV surface mount package, ideal for automatic assembly lines.

D²PAK HV package offers increased creepage distance of 5.38 mm, simplifying design conformity with insulation coordination standards such as IEC60664-1 and UL-840.

1 Characteristics

Table 1. Absolute ratings (limiting values)

Symbol	Parameter		Value	Unit	
$I_{T(RMS)}$	RMS on-state current (180 ° conduction angle)		40	A	
$I_{T(AV)}$	Average on-state current (180 ° conduction angle)				
I_{TSM}	Non repetitive surge peak on-state current, $V_R = 0$ V	$t_p = 8.3$ ms	440	A	
		$t_p = 10$ ms			
I^2t	I^2t value for fusing	$t_p = 10$ ms	$T_j = 25$ °C	800	A ² s
di/dt	Critical rate of rise of on-state current, $I_G = 2 \times I_{GT}$, $t_r \leq 100$ ns	$f = 50$ Hz	$T_j = 150$ °C	200	A/ μ s
V_{DRM} / V_{RRM}	Repetitive off-state voltage		$T_j = 150$ °C	1200	V
V_{DSM} / V_{RSM}	Non repetitive surge peak off-state voltage	$t_p = 10$ ms	$T_j = 25$ °C	1400	V
V_{GM}	Peak forward gate voltage	$t_p = 20$ μ s	$T_j = 150$ °C	10	V
I_{GM}	Peak forward gate current	$t_p = 20$ μ s	$T_j = 150$ °C	8	A
V_{RGM}	Maximum peak reverse gate voltage		$T_j = 25$ °C	5	V
$P_{G(AV)}$	Average gate power dissipation		$T_j = 150$ °C	1	W
T_{stg}	Storage junction temperature range			-40 to +150	°C
T_j	Operating junction temperature			-40 to +150	°C

Table 2. Electrical characteristics ($T_j = 25$ °C unless otherwise specified)

Symbol	Test Conditions		Value	Unit	
I_{GT}	$V_D = 12$ V, $R_L = 33$ Ω	Min.	10	mA	
		Max.	50		
V_{GT}		Max.	1.3	V	
I_{GD}	$V_D = 800$ V, $R_L = 3.3$ Ω	$T_j = 150$ °C	Min.	3	mA
V_{GD}	$V_D = 800$ V, $R_L = 3.3$ Ω	$T_j = 150$ °C	Min.	0.2	V
I_H	$I_T = 500$ mA, gate open		Max.	100	mA
I_L	$I_G = 1.2 \times I_{GT}$		Max.	125	mA
dV/dt	$V_D = 800$ V, gate open	$T_j = 150$ °C	Min.	1000	V/ μ s

Table 3. Timing Parameters

Symbol	Test Conditions		Value	Unit	
t_{gt}	$I_T = 80$ A, $V_D = 800$ V, $I_G = 100$ mA, $dI_G/dt = 0.2$ A/ μ s		Typ.	1	μ s
t_q	$I_{TM} = 25$ A, $V_D = 800$ V, $dI_T/dt = 10$ A/ μ s, $V_R = 75$ V, $dV_D/dt = 20$ V/ μ s, $t_p = 100$ μ s	$T_j = 150$ °C	Typ.	150	μ s

Table 4. Static Characteristics

Symbol	Test Conditions		Value	Unit	
V_{TM}	$I_{TM} = 80$ A, $t_p = 380$ μ s	$T_j = 25$ °C	Max.	1.55	V

Symbol	Test Conditions			Value	Unit
V_{TO}	On-state threshold voltage	$T_j = 150\text{ °C}$	Max.	0.83	V
R_D	On-state dynamic resistance	$T_j = 150\text{ °C}$	Max.	10	mΩ
I_{DRM}/I_{RRM}	$V_D = V_{DRM}, V_R = V_{RRM}$	$T_j = 25\text{ °C}$	Max.	5	μA
		$T_j = 125\text{ °C}$		0.9	mA
		$T_j = 150\text{ °C}$		6	mA
I_{DSM}/I_{RSM}	$V_D = V_{DSM}, V_R = V_{RSM}$	$T_j = 25\text{ °C}$	Max.	10	μA

Table 5. Thermal parameters

Symbol	Parameter	Value	Unit
$R_{th(j-c)}$	Junction to case (DC)	Max.	0.4
$R_{th(j-a)}$	Junction to ambient (DC, $S_{CU} = 2.5\text{ cm}^2$, $e_{CU} = 70\text{ μm}$)	Typ.	45

1.1 Characteristics (curves)

Figure 1. Maximum average power dissipation versus average on-state current

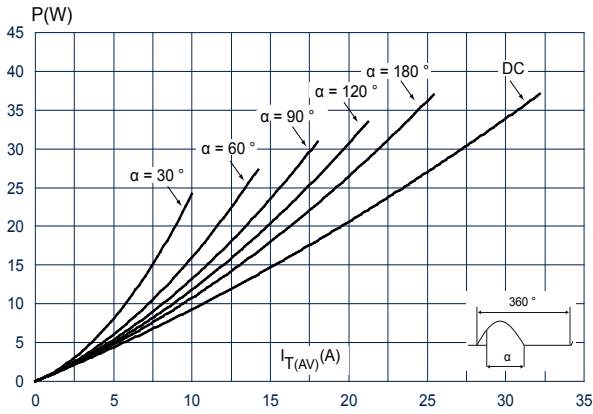

Figure 2. Average and D.C. on-state current versus case temperature

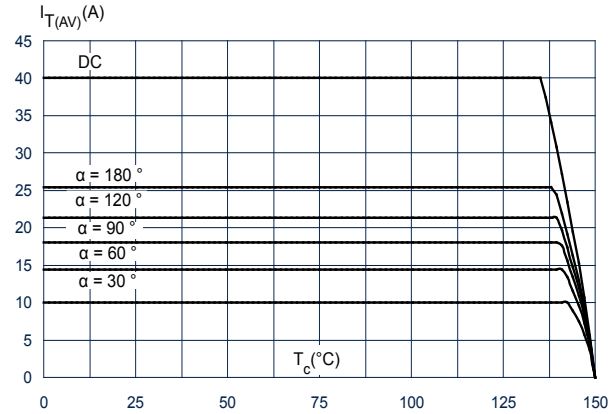

Figure 3. Average and D.C. on-state current versus ambient temperature

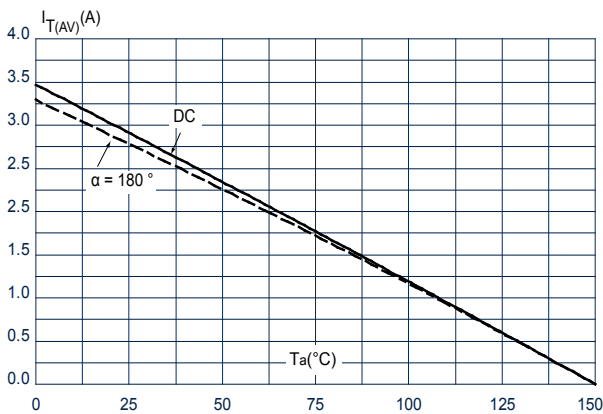

Figure 4. On-state characteristics (maximum values)

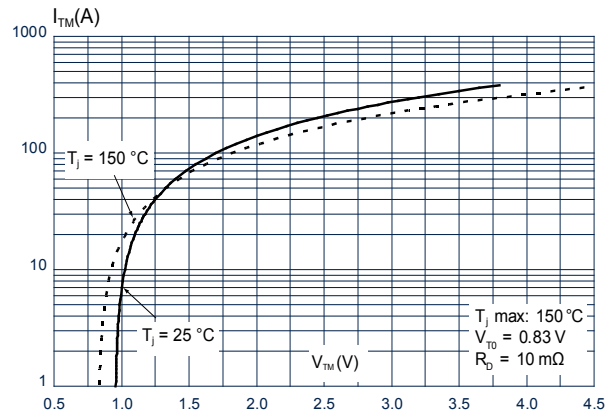

Figure 5. Surge peak on-state current versus number of cycles

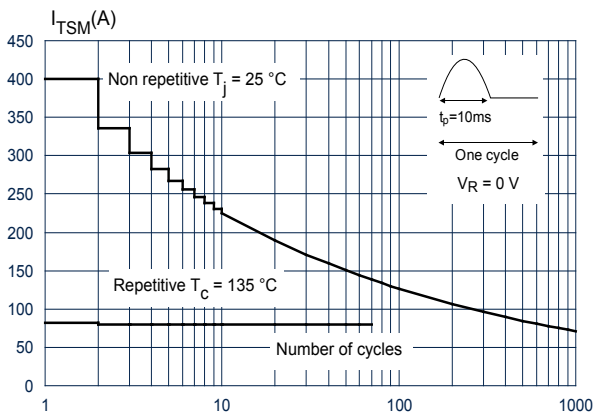

Figure 6. Non repetitive surge peak on-state current for a sinusoidal pulse with width $t_p < 10 \text{ ms}$

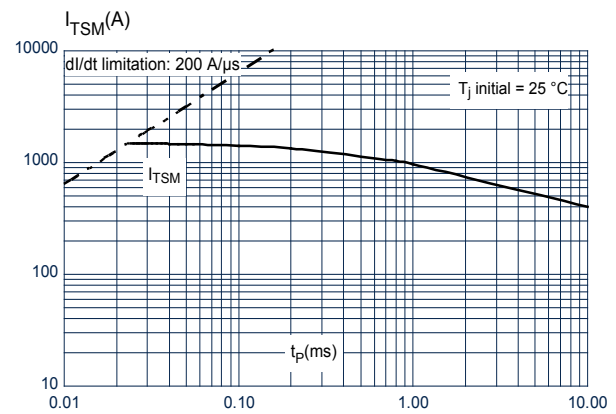
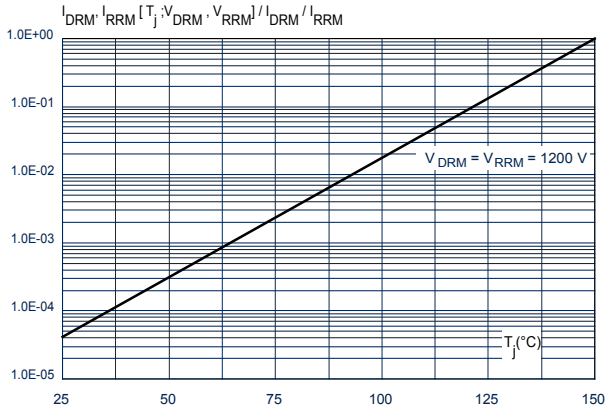
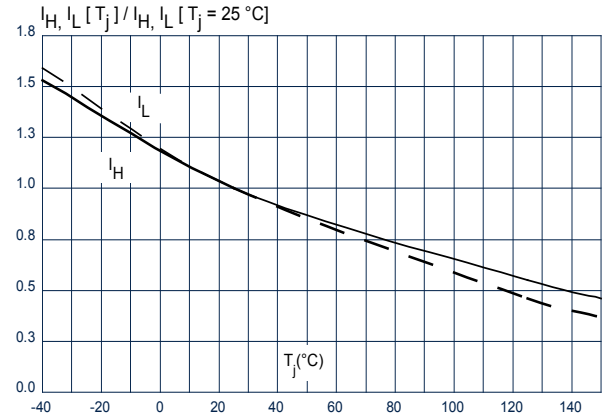
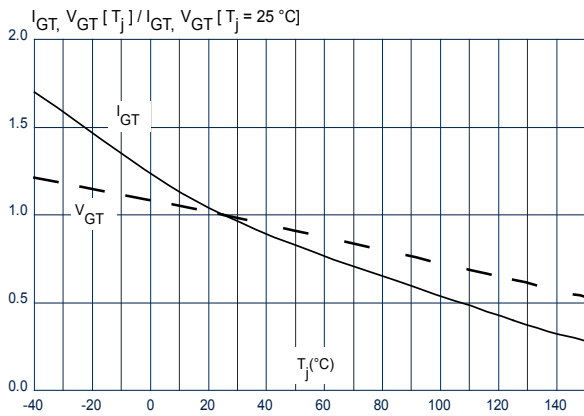
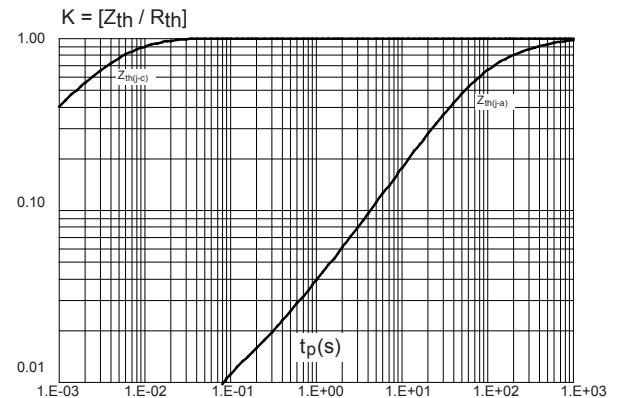
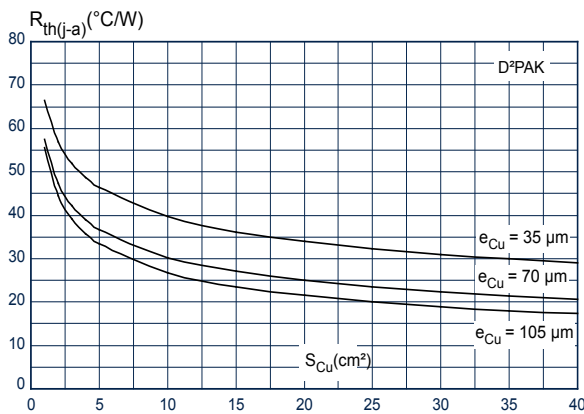
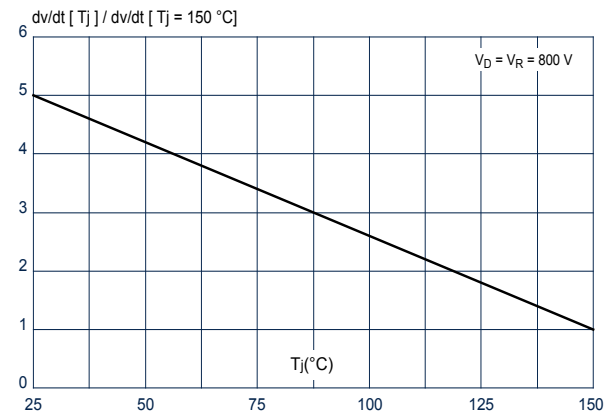

Figure 7. Relative variation of leakage current versus junction temperature for different values of blocking voltage (typical values)

Figure 8. Relative variation of holding and latching current versus junction temperature (typical values)

Figure 9. Relative variation of gate trigger current and gate voltage versus junction temperature (typical values)

Figure 10. Relative variation of thermal impedance junction to case and junction to ambient versus pulse duration

Figure 11. Thermal resistance junction to ambient versus copper surface under tab (typical values, epoxy printed board FR4) (D²PAK)

Figure 12. Relative variation of static dV/dt immunity versus junction temperature

2 Package information

In order to meet environmental requirements, ST offers these devices in different grades of **ECOPACK** packages, depending on their level of environmental compliance. ECOPACK specifications, grade definitions and product status are available at: www.st.com. ECOPACK is an ST trademark.

2.1 D²PAK high voltage package information

- Epoxy meets UL94, V0

Figure 13. D²PAK high voltage package outline

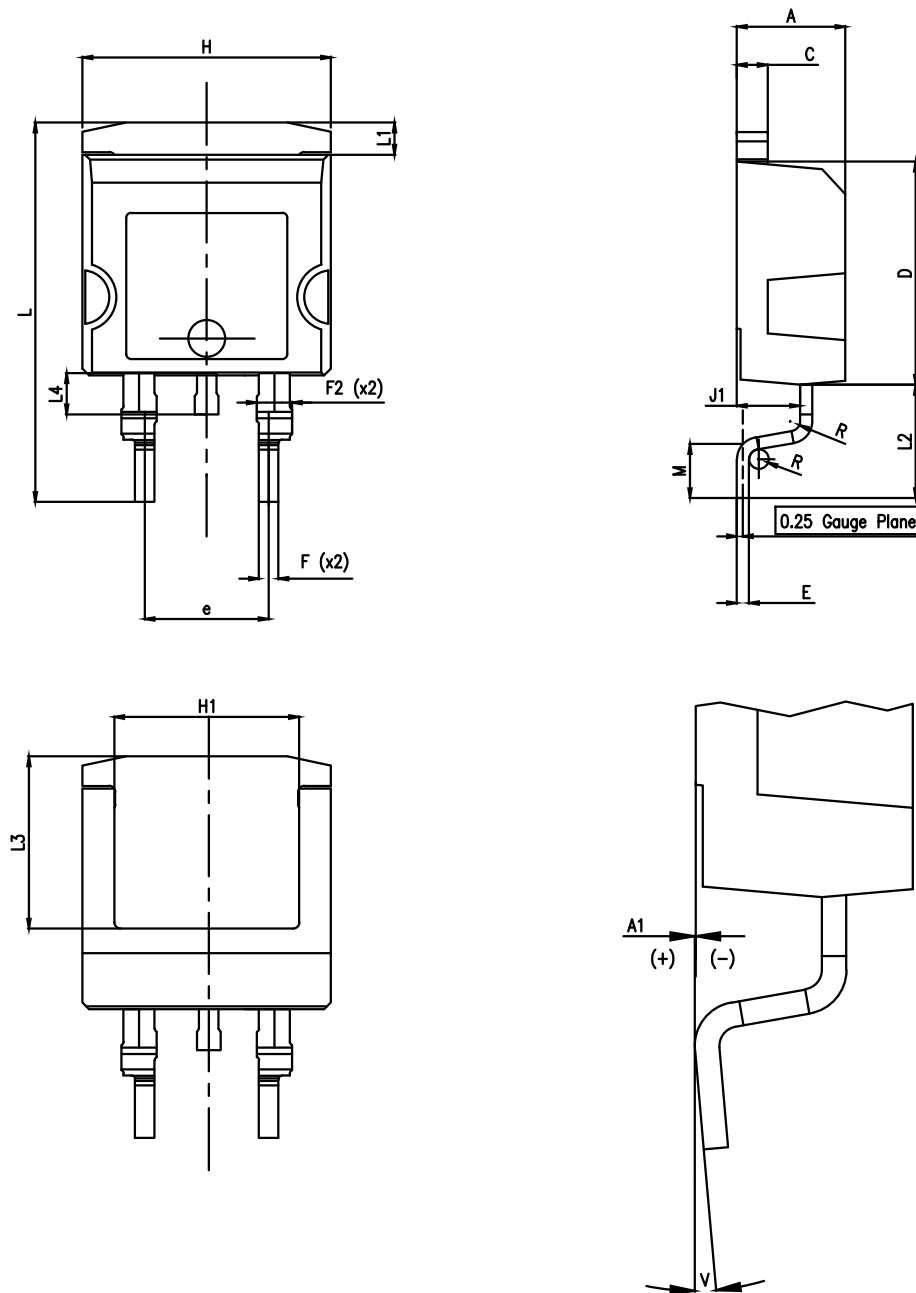
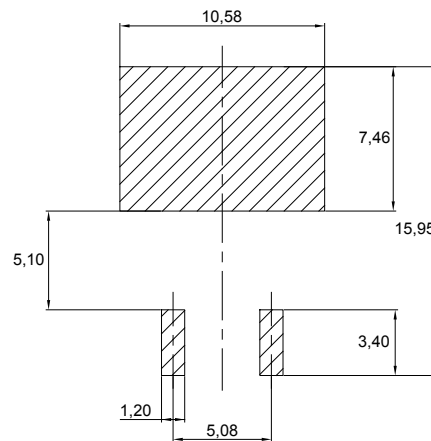

Table 6. D²PAK high voltage package mechanical data

Ref.	Dimensions			
	Millimeters		Inches	
	Min.	Max.	Min.	Max.
A	4.30	4.70	0.1692	0.1851
A1	0.03	0.20	0.0011	0.0079
C	1.17	1.37	0.0460	0.0540
D	8.95	9.35	0.3523	0.3682
e	4.98	5.18	0.1960	0.2040
E	0.50	0.90	0.0196	0.0355
F	0.78	0.85	0.0307	0.0335
F2	1.14	1.70	0.0448	0.0670
H	10.00	10.40	0.3937	0.4095
H1	7.40	7.80	0.2913	0.3071
J1	2.49	2.69	0.0980	0.1060
L	15.30	15.80	0.6023	0.6221
L1	1.27	1.40	0.0500	0.0552
L2	4.93	5.23	0.1940	0.2060
L3	6.85	7.25	0.2696	0.2855
L4	1.50	1.7	0.0590	0.0670
M	2.60	2.9	0.1023	0.1142
R	0.20	0.60	0.0078	0.0237
V	0°	8°	0°	8°

Figure 14. D²PAK high voltage footprint in mm



Note: For package and tape orientation, reel and inner box dimensions and tape outline please check TN1173.

2.1.1 Creepage distance between anode and cathode

Table 7. Creepage distance between anode and cathode

Symbol	Parameter		Value	Unit
Cd _{K-A1}	Minimum creepage distance between K and A1 (with top coating)	D ² PAK HV	5.38	mm
Cd _{K-A2}	Minimum creepage distance between K and A2 (without top coating)		3.48	

Note: D²PAK HV creepage distance (anode to cathode) = 5.38 mm min. (refer to IEC 60664-1)

Figure 15. Creepage with top coating

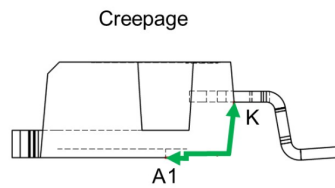

Minimum distance between K & A1 = 5.38 mm (with top coating)

Figure 16. Creepage without top coating

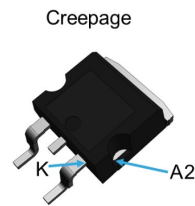

Minimum distance between K & A2 = 3.48 mm (without top coating)

3 Ordering information

Figure 17. Ordering information scheme

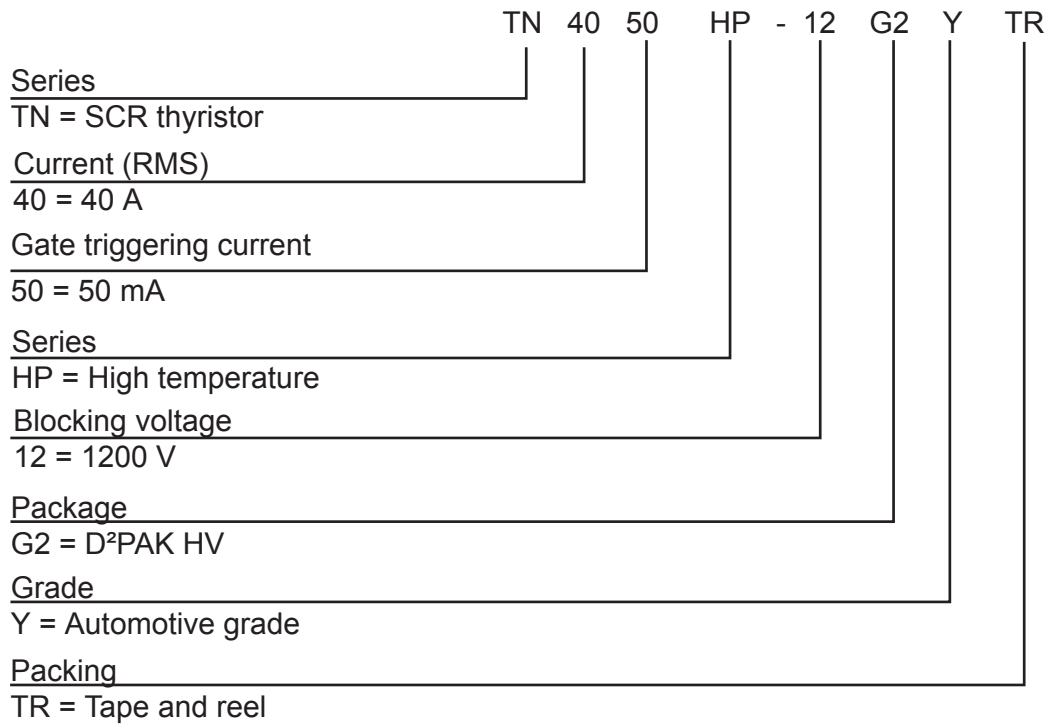

Table 8. Ordering information

Order code	Marking	Package	Weight	Base qty.	Delivery mode
TN4050HP-12G2YTR	TN40P12YB2	D ² PAK HV	1.38 g	1000	Tape and reel 13"

Revision history

Table 9. Document revision history

Date	Revision	Changes
03-Aug-2021	1	Initial release.
16-Dec-2021	2	Updated Table 2 . Added Figure 6 and Figure 11 .

IMPORTANT NOTICE – PLEASE READ CAREFULLY

STMicroelectronics NV and its subsidiaries (“ST”) reserve the right to make changes, corrections, enhancements, modifications, and improvements to ST products and/or to this document at any time without notice. Purchasers should obtain the latest relevant information on ST products before placing orders. ST products are sold pursuant to ST’s terms and conditions of sale in place at the time of order acknowledgement.

Purchasers are solely responsible for the choice, selection, and use of ST products and ST assumes no liability for application assistance or the design of Purchasers’ products.

No license, express or implied, to any intellectual property right is granted by ST herein.

Resale of ST products with provisions different from the information set forth herein shall void any warranty granted by ST for such product.

ST and the ST logo are trademarks of ST. For additional information about ST trademarks, please refer to www.st.com/trademarks. All other product or service names are the property of their respective owners.

Information in this document supersedes and replaces information previously supplied in any prior versions of this document.

© 2021 STMicroelectronics – All rights reserved