

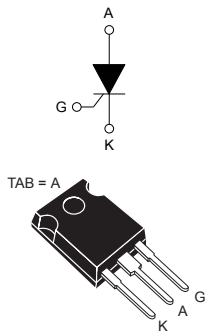

60 A 1200 V automotive grade thyristor (SCR)



TO-247 uninsulated

Features

- AEC-Q101 qualified 
- High junction temperature: 150 °C
- AC off state voltage: +/- 1200 V
- Nominal on-state RMS current: 60 A_{RMS}
- High noise immunity: 1000 V/μs
- Max. gate triggering current: 50 mA
- ECOPACK2 compliant component

Applications

- On board, off board Automotive battery charger
- AC DC voltage controlled rectifier
- Solar and wind renewable energy inverters / rectifiers
- Solid state relays
- UPS: Bypass SSR; inrush current limiter ICL in AC DC rectifier

Description

The TN6050HP-12WY is an automotive grade SCR thyristor designed for applications such as automotive on board and stationary battery chargers.

This SCR thyristor, rated for a 60 A RMS power switching, offers superior performances in peak voltage robustness up to 1400 V and surge current handling up to 600 A sine wave pulse. Its key features allow the design of functions such as AC switch and AC-DC controlled rectifier-bridge.

The TN6050HP-12WY is available in TO-247 package, ideal for a maximum thermal performance.

Product status	
TN6050HP-12WY	
Product summary	
$I_{T(RMS)}$	60 A
V_{DRM}/V_{RRM}	1200 V
V_{DSM}/V_{RSM}	1400 V
I_{GT}	50 mA
T_j	-40 to 150 °C

1 Characteristics

Table 1. Absolute ratings (limiting values)

Symbol	Parameter		Value	Unit
$I_{T(RMS)}$	RMS on-state current (180 ° conduction angle)		60	A
$I_{T(AV)}$	Average on-state current (180 ° conduction angle)			
I_{TSM}	Non repetitive surge peak on-state current, $V_R = 0$ V	$t_p = 8.3$ ms	660	A
		$t_p = 10$ ms		
I^2t	I^2t value for fusing	$t_p = 10$ ms	1800	A ² s
di/dt	$I_G = 2 \times I_{GT}$, $t_r \leq 100$ ns Critical rate of rise of on-state current	$f = 50$ Hz	200	A/ μ s
V_{DRM} / V_{RRM}	Repetitive off-state voltage		1200	V
V_{DSM} / V_{RSM}	Non repetitive surge peak off-state voltage	$t_p = 10$ ms	1400	V
V_{GM}	Peak forward gate voltage	$t_p = 20$ μ s	10	V
I_{GM}	Peak forward gate current	$t_p = 20$ μ s	8	A
V_{RGM}	Maximum peak reverse gate voltage		5	V
$P_{G(AV)}$	Average gate power dissipation		1	W
T_{stg}	Storage junction temperature range			-40 to +150 °C
T_j	Operating junction temperature			-40 to +150 °C

Table 2. Electrical characteristics ($T_j = 25$ °C unless otherwise specified)

Symbol	Test Conditions		Value	Unit	
I_{GT}	$V_D = 12$ V, $R_L = 33$ Ω	Min.	10	mA	
		Max.	50		
V_{GT}		Max.	1.3	V	
V_{GD}	$V_D = 800$ V, $R_L = 3.3$ k Ω	$T_j = 150$ °C	Min.	0.2	V
I_H	$I_T = 500$ mA, gate open		Max.	100	mA
I_L	$I_G = 1.2 \times I_{GT}$		Max.	125	mA
dV/dt	$V_D = 800$ V, gate open	$T_j = 150$ °C	Min.	1000	V/ μ s

Table 3. Timing Parameters

Symbol	Test Conditions		Value	Unit	
t_{gt}	$I_T = 120$ A, $V_D = 800$ V, $I_G = 100$ mA, $di_G/dt = 0.2$ A/ μ s		Typ.	1	μ s
t_q	$I_{TM} = 38$ A, $V_D = 800$ V, $di_T/dt = 10$ A/ μ s, $V_R = 75$ V, $dV_D/dt = 20$ V/ μ s, $t_p = 100$ μ s	$T_j = 150$ °C	Typ.	150	μ s

Table 4. Static Characteristics

Symbol	Test Conditions			Value	Unit
V_{TM}	$I_{TM} = 120\text{ A}$, $t_p = 380\ \mu\text{s}$	$T_j = 25\ ^\circ\text{C}$	Max.	1.5	V
V_{TO}	On-state threshold voltage	$T_j = 150\ ^\circ\text{C}$	Max.	0.83	V
R_D	On-state dynamic resistance	$T_j = 150\ ^\circ\text{C}$	Max.	6	m Ω
I_{DRM}/I_{RRM}	$V_D = V_{DRM}$, $V_R = V_{RRM}$	$T_j = 25\ ^\circ\text{C}$	Max.	5	μA
		$T_j = 125\ ^\circ\text{C}$	Max.	3	mA
		$T_j = 150\ ^\circ\text{C}$	Max.	7.5	mA
I_{DSM}/I_{RSM}	$V_D = V_{DSM}$, $V_R = V_{RSM}$	$T_j = 25\ ^\circ\text{C}$	Max.	10	μA

Table 5. Thermal parameters

Symbol	Parameter		Value	Unit
$R_{th(j-c)}$	Junction to case (DC)	Max.	0.3	$^\circ\text{C}/\text{W}$
$R_{th(j-a)}$	Junction to ambient	Typ.	50	

1.1 Characteristics curves

Figure 1. Maximum average power dissipation versus average on-state current

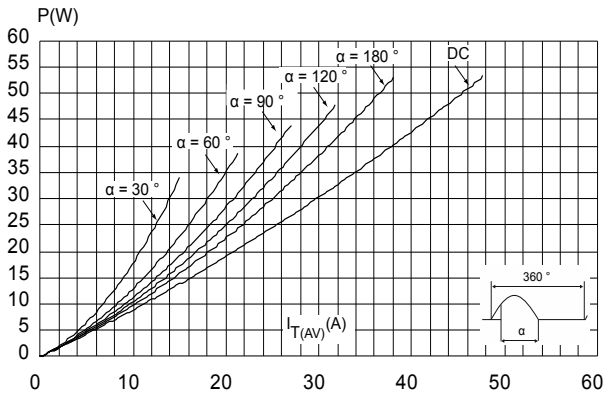

Figure 2. Average on-state current versus case temperature

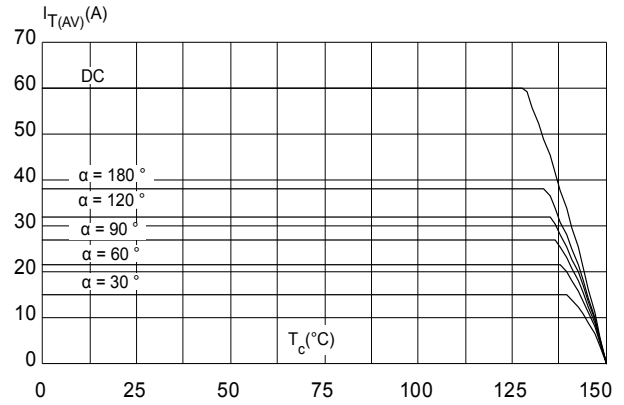

Figure 3. On-state characteristics (maximum values)

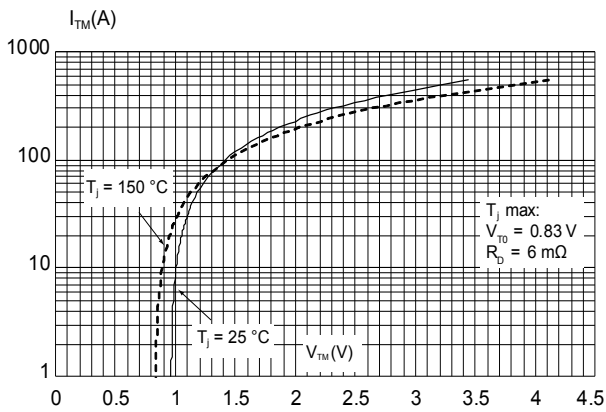

Figure 4. Average on-state current versus ambient temperature

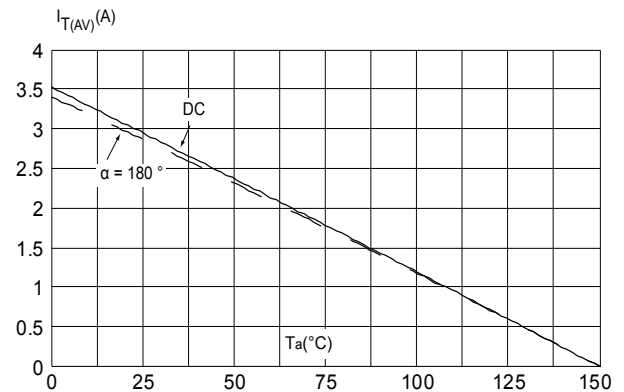

Figure 5. Relative variation of thermal impedance junction to case and junction to ambient versus pulse duration

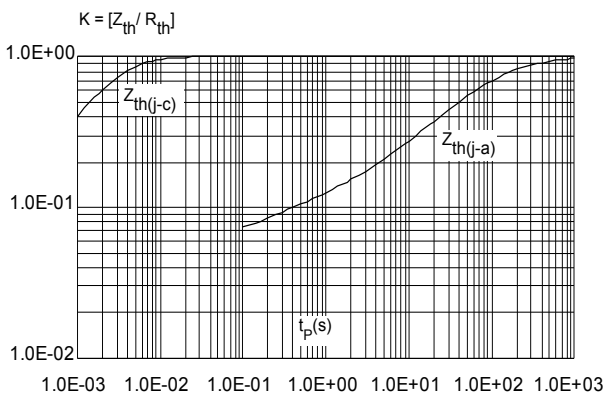

Figure 6. Surge peak on-state current versus number of cycles

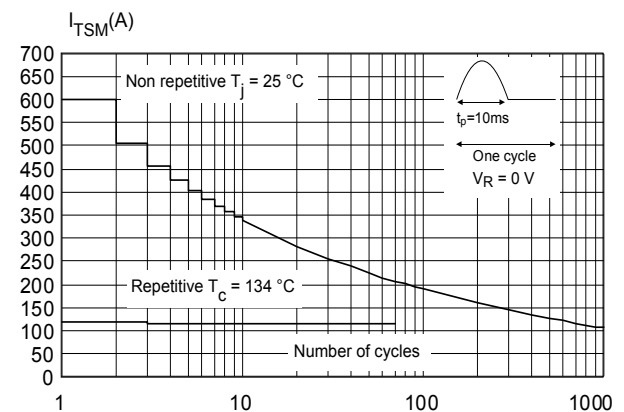

Figure 7. Non repetitive surge peak on-state current for a sinusoidal pulse ($t_p < 10$ ms)

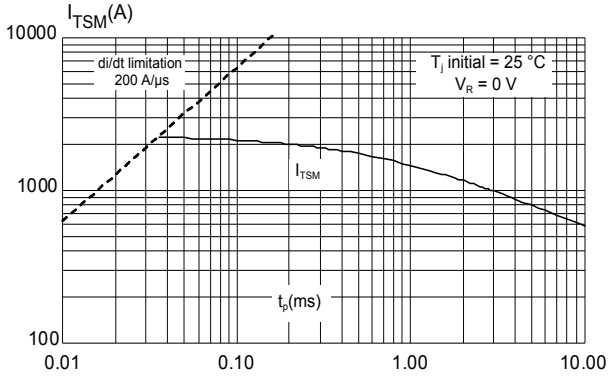

Figure 8. Relative variation of holding and latching current versus junction temperature (typical values)

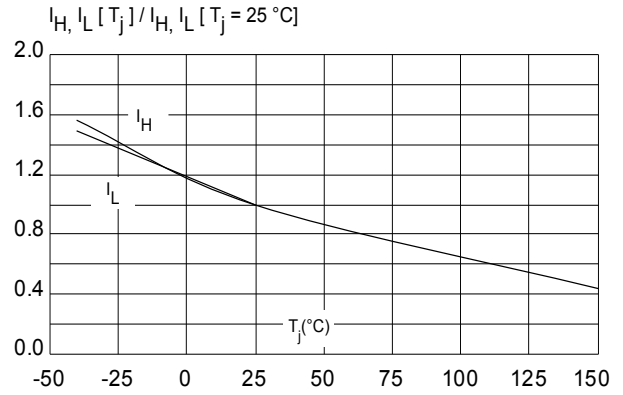

Figure 9. Relative variation of gate trigger current and gate voltage versus junction temperature (typical values)

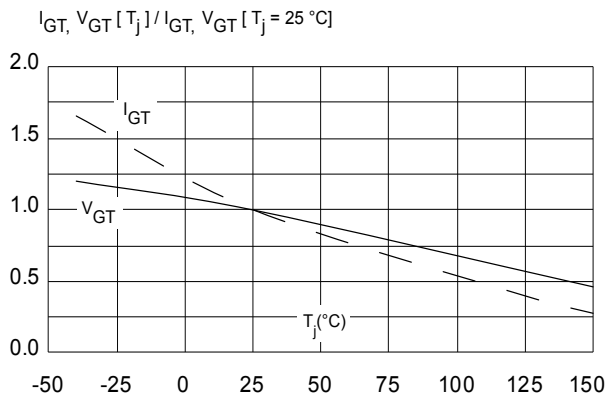

Figure 10. Relative variation of static dV/dt immunity versus junction temperature

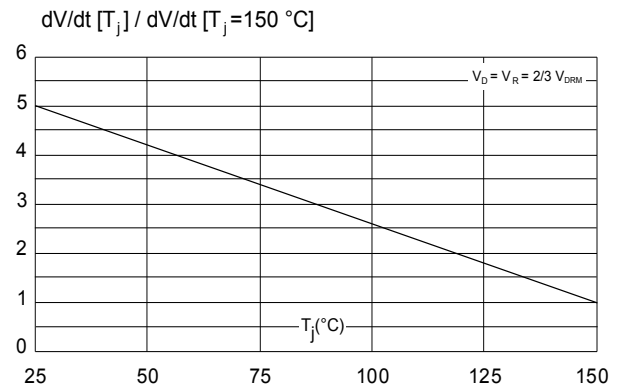
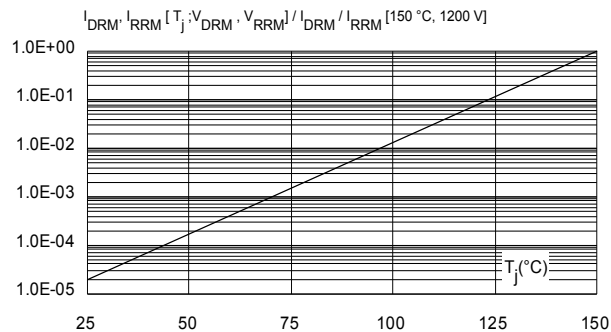

Figure 11. Relative variation of leakage current versus junction temperature for maximum of blocking voltage (typical values)



2 Package information

In order to meet environmental requirements, ST offers these devices in different grades of **ECOPACK** packages, depending on their level of environmental compliance. ECOPACK specifications, grade definitions and product status are available at: www.st.com. ECOPACK is an ST trademark.

2.1 TO-247 package information

- Epoxy meets UL 94,V0
- Recommended torque value: 0.8 N·m
- Maximum torque value: 1 N·m

Figure 12. TO-247 package outline

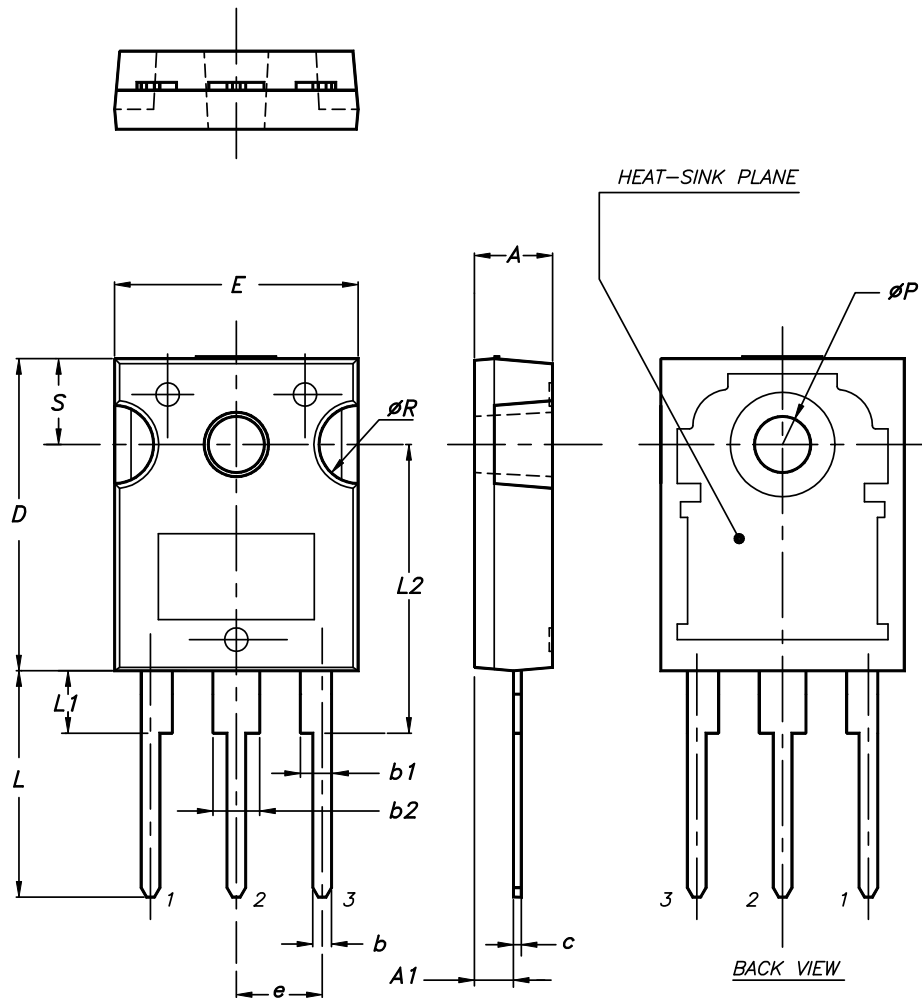

0075325_9

Table 6. TO-247 package mechanical data

Dim.	Dimensions					
	Millimeters			Inches ⁽¹⁾		
	Min.	Typ.	Max.	Min.	Typ.	Max.
A	4.85		5.15	0.1909		0.2028
A1	2.20		2.60	0.0866		0.1024
b	1.0		1.40	0.0394		0.0551
b1	2.0		2.40	0.0787		0.0945
b2	3.0		3.40	0.1181		0.1339
c	0.40		0.80	0.0157		0.0315
D ⁽²⁾	19.85		20.15	0.7815		0.7933
E	15.45		15.75	0.6083		0.6201
e	5.30	5.45	5.60	0.2087	0.2146	0.2205
L	14.20		14.80	0.5591		0.5827
L1	3.70		4.30	0.1457		0.1693
L2		18.50			0.7283	
ØP ⁽³⁾	3.55		3.65	0.1398		0.1437
ØR	4.50		5.50	0.1772		0.2165
S	5.30	5.50	5.70	0.2087	0.2165	0.2244

1. Inch dimensions given only for reference
2. Dimension D plus gate protrusion does not exceed 20.5 mm
3. Resin thickness around the mounting hole is not less than 0.9 mm

3 Ordering information

Table 7. Ordering information

Order code	Marking	Package	Weight	Base qty.	Delivery mode
TN6050HP-12WY	TN6050HP12Y	TO-247	4.43 g	30	Tube

Revision history

Table 8. Document revision history

Date	Revision	Changes
24-Apr-2020	1	Initial release.
04-Mar-2021	2	Updated Figure 3 .
21-Sep-2021	3	Updated Features and Description on cover page. Updated Table 4 and Figure 6 .

IMPORTANT NOTICE – PLEASE READ CAREFULLY

STMicroelectronics NV and its subsidiaries (“ST”) reserve the right to make changes, corrections, enhancements, modifications, and improvements to ST products and/or to this document at any time without notice. Purchasers should obtain the latest relevant information on ST products before placing orders. ST products are sold pursuant to ST’s terms and conditions of sale in place at the time of order acknowledgement.

Purchasers are solely responsible for the choice, selection, and use of ST products and ST assumes no liability for application assistance or the design of Purchasers’ products.

No license, express or implied, to any intellectual property right is granted by ST herein.

Resale of ST products with provisions different from the information set forth herein shall void any warranty granted by ST for such product.

ST and the ST logo are trademarks of ST. For additional information about ST trademarks, please refer to www.st.com/trademarks. All other product or service names are the property of their respective owners.

Information in this document supersedes and replaces information previously supplied in any prior versions of this document.

© 2021 STMicroelectronics – All rights reserved