

- Standard gain guided type MQW InGaAlP VLD
- Package flange:  $\varnothing 9\text{mm}$
- Applications include:  
Bar code scanners, laser pointer, measurement systems, etc.

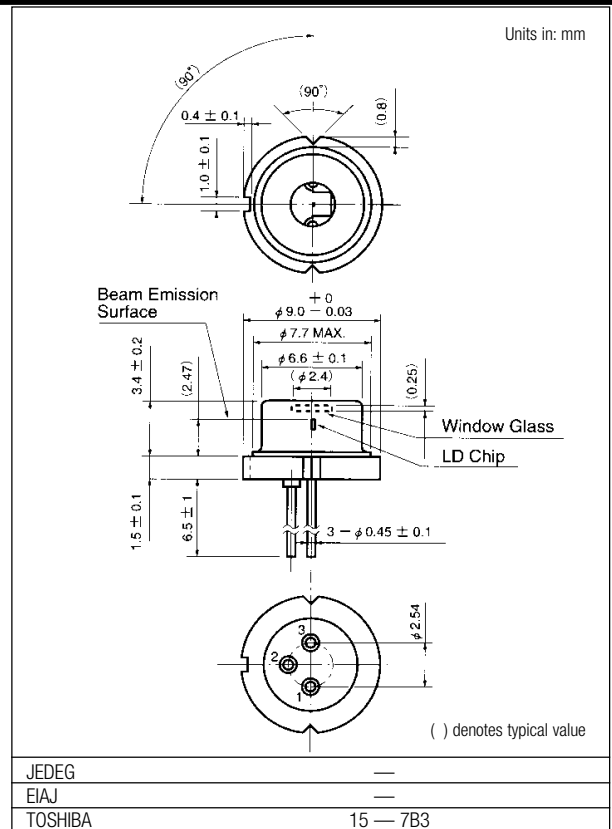
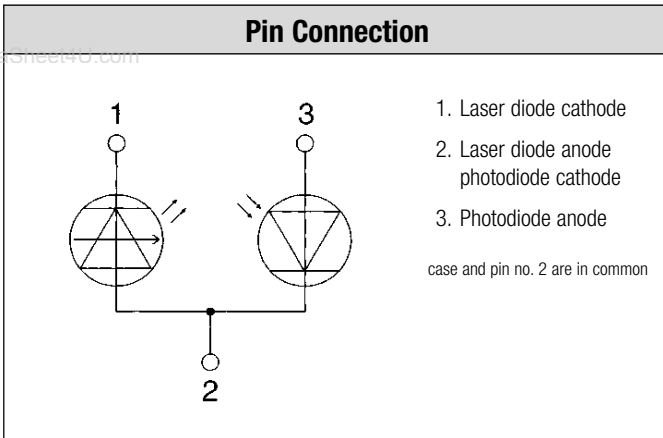

### Maximum ratings (Tc=25°C)

Characteristic	Symbol	Rating	Unit
Optical Output Power(CW)	$P_O$	3	mW
LD Reverse Voltage	$V_{R(LD)}$	2	V
PD Reverse Voltage	$V_{R(PD)}$	30	V
Operation Case Temperature	$T_C$	-10~50	°C
Storage Temperature	$T_{stg}$	-40~85	°C

### Optical-electrical characteristics (Tc=25°C)

Characteristic	Symbol	Test Condition	Min.	Typ.	Max.	Unit
Threshold Current	$I_{th}$	CW operation	—	50	75	mA
Operation Current	$I_{op}$	$P_o=3\text{mW}$	—	55	80	mA
Operation Voltage	$V_{op}$	$P_o=3\text{mW}$	—	2.2	3.0	V
Lasing Wavelength	$\lambda_p$	$P_o=3\text{mW}$	660	670	680	nm
Beam Divergence	$\theta_{  }$	$P_o=3\text{mW}$	7	10	16	°
	$\theta_{\perp}$	$P_o=3\text{mW}$	26	32	38	°
Monitor Current	$I_m$	$P_o=3\text{mW}$	0.15	0.5	0.95	mA
PD Dark Current	$I_{b(PD)}$	$V_R=5\text{V}$	—	—	100	nA
PD Total Capacitance	$C_{T(PD)}$	$V_R=5\text{V}$ , $f=1\text{MHz}$	—	—	20	pF

# Examples of Typical Characteristics

**Optical Output Power vs. Forward Current**

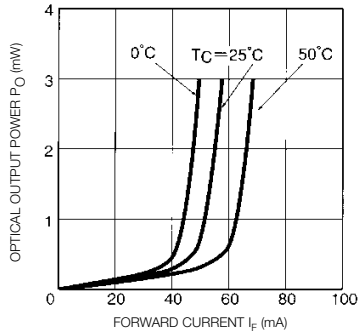

**Forward Current vs. Forward Voltage**

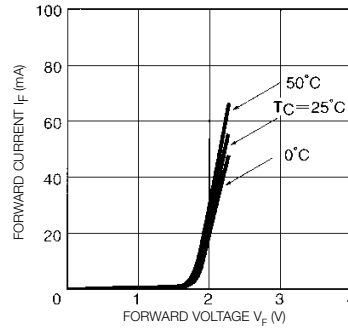

**Case Temperature Dependence of Threshold Current**

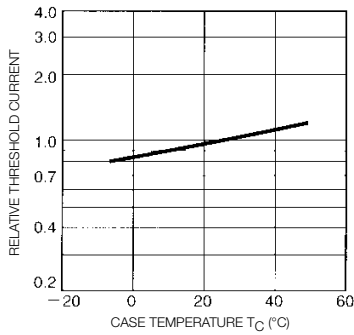

**Case Temperature Dependence of Lasing Wavelength**

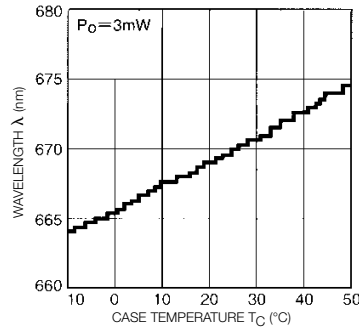

**Far-field Patterns**

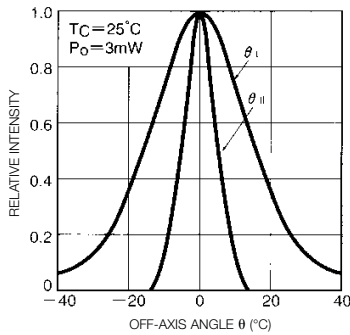

**Lasing Spectrum**

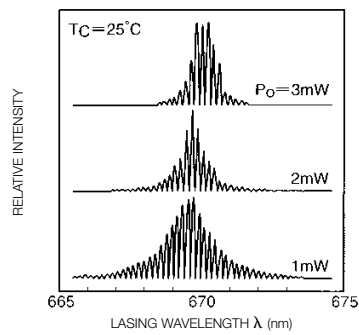

**Monitor current vs. Optical Output Power**

