

TP1.5KE Series

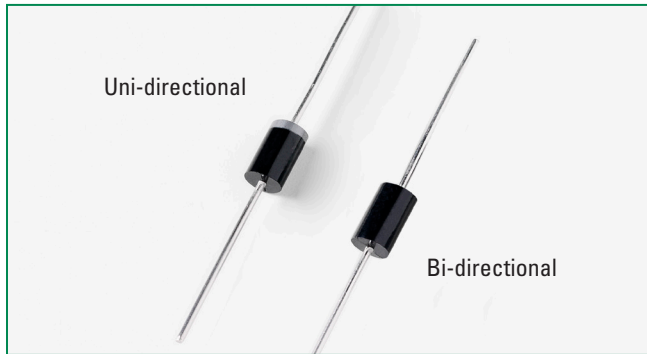

Agency Approvals

| AGENCY | AGENCY FILE NUMBER |
|--------|--------------------|
| | E230531 |

Maximum Ratings and Thermal Characteristics (T_A=25°C unless otherwise noted)

| Parameter | Symbol | Value | Unit |
|--|------------------|------------|------|
| Peak Pulse Power Dissipation by 10/1000µs Test Waveform (Fig.2) (Note 1) | P _{PPM} | 1500 | W |
| Steady State Power Dissipation on Infinite Heat Sink at T _L =75°C | P _D | 6.5 | W |
| Peak Forward Surge Current, 8.3ms Single Half Sine Wave Unidirectional Only (Note 2) | I _{FSM} | 200 | A |
| Maximum Instantaneous Forward Voltage at 100A for Unidirectional Only (Note 3) | V _F | 3.5 | V |
| Operating Junction Temperature Range | T _J | -55 to 150 | °C |
| Storage Temperature Range | T _{STG} | -55 to 175 | °C |
| Typical Thermal Resistance Junction to Lead | R _{θJL} | 15 | °C/W |
| Typical Thermal Resistance Junction to Ambient | R _{θJA} | 75 | °C/W |

- Notes:**
1. Non-repetitive current pulse, per Fig. 4 and derated above T_J (initial) =25°C per Fig. 3.
 2. Measured on 8.3ms single half sine wave or equivalent square wave, duty cycle=4 per minute maximum.

Functional Diagram

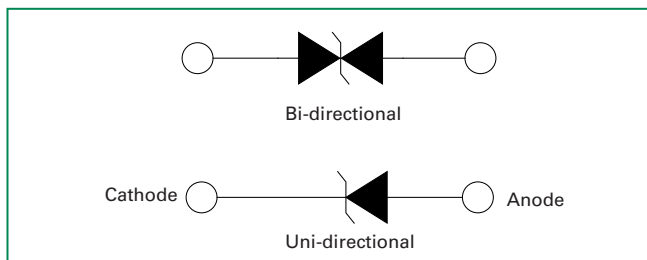

Description

The TP1.5KE Series is designed specifically to protect sensitive electronic equipment from voltage transients induced by lightning and other transient voltage events.

Features

- Hi reliability application and automotive grade AEC-Q101 rev D qualified
- Glass passivated chip junction in DO-201 Package
- 1500W peak pulse capability at 10/1000µs waveform, repetition rate (duty cycles):0.01%
- Fast response time: typically less than 1.0ps from 0 Volts to BV min
- Excellent clamping capability
- Typical failure mode is short from over-specified voltage or current
- Whisker test is conducted based on JEDEC JESD201A per its table 4a and 4c
- IEC-61000-4-2 ESD 30kV(Air), 30kV (Contact)
- ESD protection of data lines in accordance with IEC 61000-4-2
- EFT protection of data lines in accordance with IEC 61000-4-4
- Low incremental surge resistance
- High temperature to reflow soldering guaranteed: 260°C/10sec / 0.375"(9.5mm) lead length, 5 lbs., (2.3kg) tension
- V_{BR} @ T_J = V_{BR} @ 25°C x (1 + α T x (T_J - 25)) (α T: Temperature Coefficient, typical value is 0.1%)
- Plastic package is flammability rated V-0 per Underwriters Laboratories
- Matte tin lead-free plated
- Halogen free and RoHS compliant
- Pb-free E3 means 2nd level interconnect is Pb-free and the terminal finish material is tin(Sn) (IPC/JEDEC J-STD-609A.01)

Applications

TVS devices are ideal for the protection of I/O interfaces, V_{CC} bus and other vulnerable circuits used in telecom, computer, industrial and consumer electronic applications.

Electrical Characteristics ($T_A=25^\circ\text{C}$ unless otherwise noted)

| Part Number (Uni) | Part Number (Bi) | Reverse Stand off Voltage V_R (Volts) | Breakdown Voltage V_{BR} (Volts) @ I_T | | Test Current I_T (mA) | Maximum Clamping Voltage V_C @ I_{pp} (Volts) | Maximum Peak Pulse Current I_{pp} (A) | Maximum Reverse Leakage I_R @ V_R (μA) | Agency Approval  |
|-------------------|------------------|---|--|-------|-------------------------|---|---|---|---|
| | | | MIN | MAX | | | | | |
| TP1.5KE12A | TP1.5KE12CA | 10.20 | 11.40 | 12.60 | 1 | 16.7 | 91.0 | 5 | X |
| TP1.5KE13A | TP1.5KE13CA | 11.10 | 12.40 | 13.70 | 1 | 18.2 | 83.5 | 1 | X |
| TP1.5KE15A | TP1.5KE15CA | 12.80 | 14.30 | 15.80 | 1 | 21.2 | 71.7 | 1 | X |
| TP1.5KE16A | TP1.5KE16CA | 13.60 | 15.20 | 16.80 | 1 | 22.5 | 67.6 | 1 | X |
| TP1.5KE18A | TP1.5KE18CA | 15.30 | 17.10 | 18.90 | 1 | 25.2 | 60.3 | 1 | X |
| TP1.5KE20A | TP1.5KE20CA | 17.10 | 19.00 | 21.00 | 1 | 27.7 | 54.9 | 1 | X |
| TP1.5KE22A | TP1.5KE22CA | 18.80 | 20.90 | 23.10 | 1 | 30.6 | 49.7 | 1 | X |
| TP1.5KE24A | TP1.5KE24CA | 20.50 | 22.80 | 25.20 | 1 | 33.2 | 45.8 | 1 | X |
| TP1.5KE27A | TP1.5KE27CA | 23.10 | 25.70 | 28.40 | 1 | 37.5 | 40.5 | 1 | X |
| TP1.5KE30A | TP1.5KE30CA | 25.60 | 28.50 | 31.50 | 1 | 41.4 | 36.7 | 1 | X |
| TP1.5KE33A | TP1.5KE33CA | 28.20 | 31.40 | 34.70 | 1 | 45.7 | 33.3 | 1 | X |
| TP1.5KE36A | TP1.5KE36CA | 30.80 | 34.20 | 37.80 | 1 | 49.9 | 30.5 | 1 | X |
| TP1.5KE39A | TP1.5KE39CA | 33.30 | 37.10 | 41.00 | 1 | 53.9 | 28.2 | 1 | X |
| TP1.5KE43A | TP1.5KE43CA | 36.80 | 40.90 | 45.20 | 1 | 59.3 | 25.6 | 1 | X |
| TP1.5KE47A | TP1.5KE47CA | 40.20 | 44.70 | 49.40 | 1 | 64.8 | 23.5 | 1 | X |

I-V Curve Characteristics

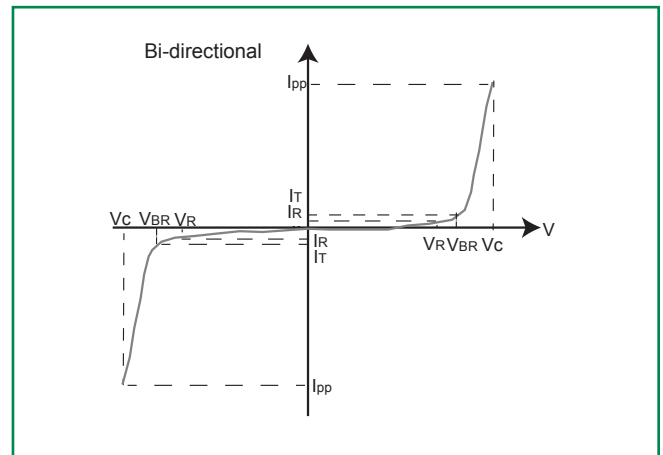
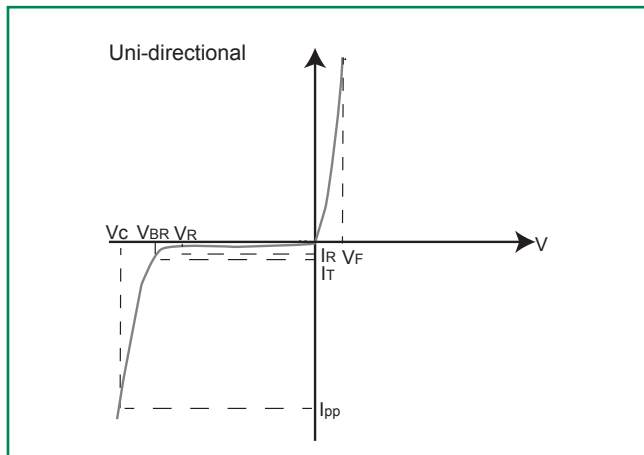

- P_{PPM} Peak Pulse Power Dissipation** – Max power dissipation
- V_R Stand-off Voltage** – Maximum voltage that can be applied to the TVS without operation
- V_{BR} Breakdown Voltage** – Maximum voltage that flows through the TVS at a specified test current (I_T)
- V_C Clamping Voltage** – Peak voltage measured across the TVS at a specified I_{ppm} (peak impulse current)
- I_R Reverse Leakage Current** – Current measured at V_R
- V_F Forward Voltage Drop for Uni-directional**

Ratings and Characteristic Curves ($T_A=25^\circ\text{C}$ unless otherwise noted)

Figure 1 - TVS Transients Clamping Waveform

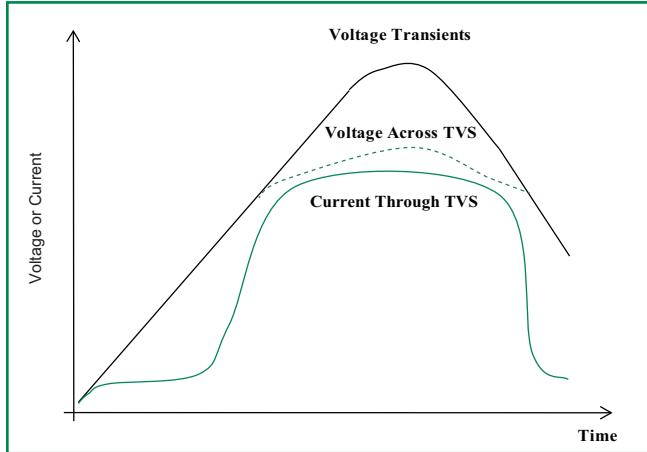

Figure 2 - Peak Pulse Power Rating

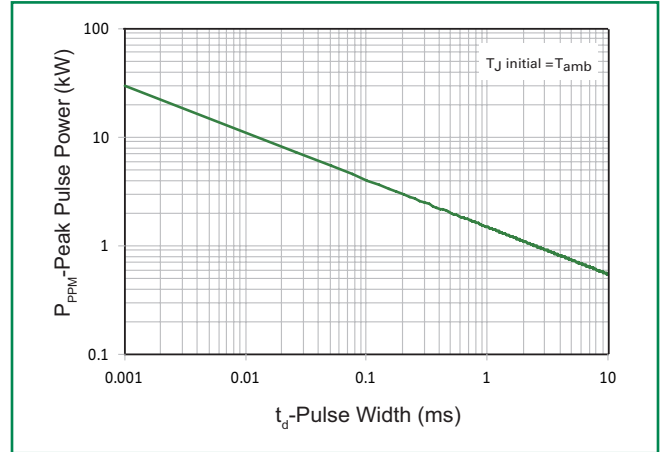

Figure 3 - Peak Pulse Power Derating Curve

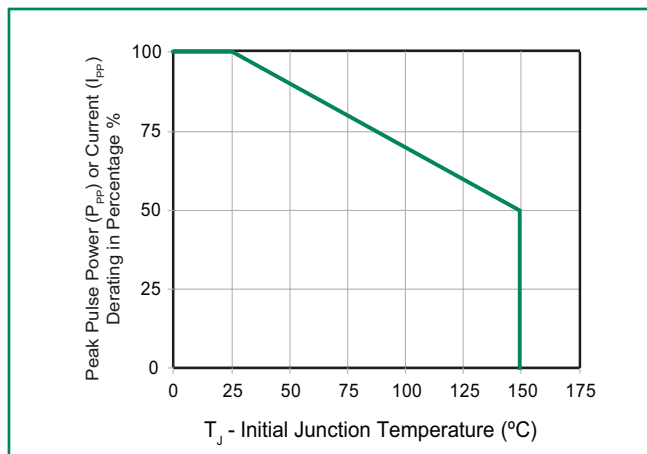

Figure 4 - Pulse Waveform

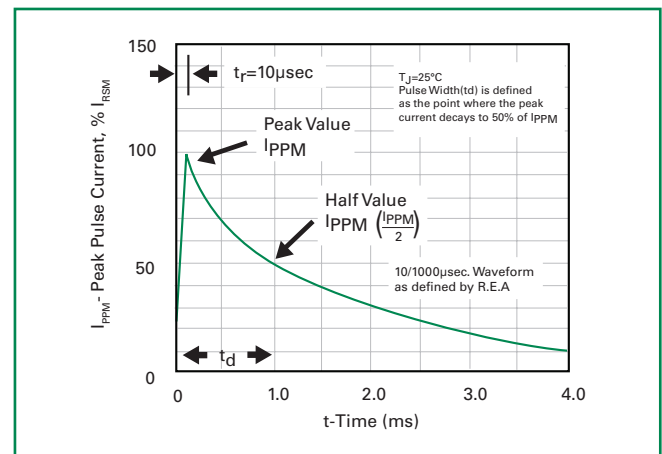

Figure 5 - Typical Junction Capacitance

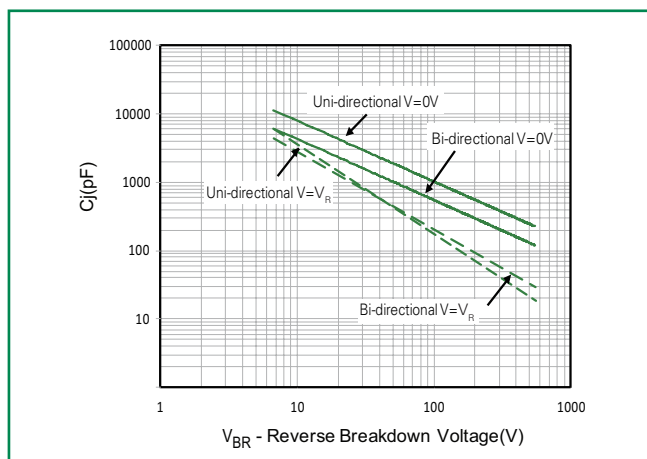
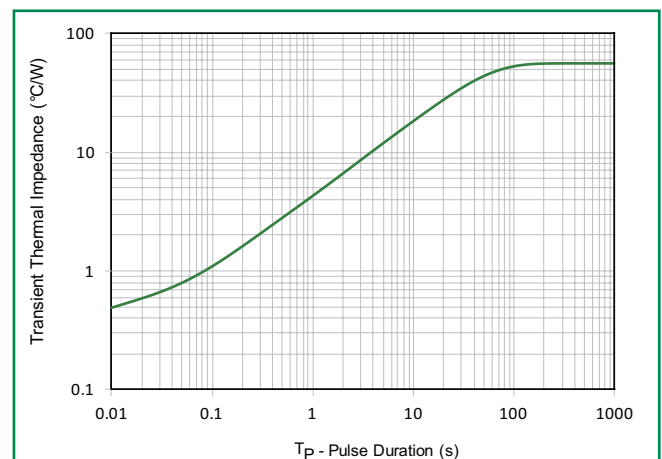

Figure 6 - Typical Transient Thermal Impedance



Ratings and Characteristic Curves ($T_A=25^\circ\text{C}$ unless otherwise noted) (Continued)

Figure 7 - Maximum Non-Repetitive Peak Forward Surge Current Uni-Directional Only

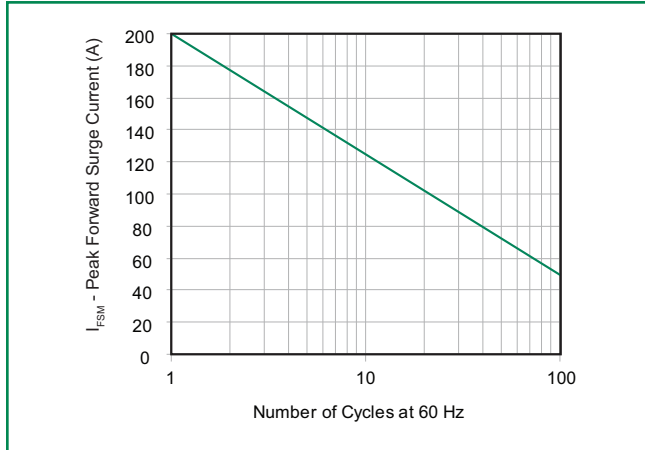
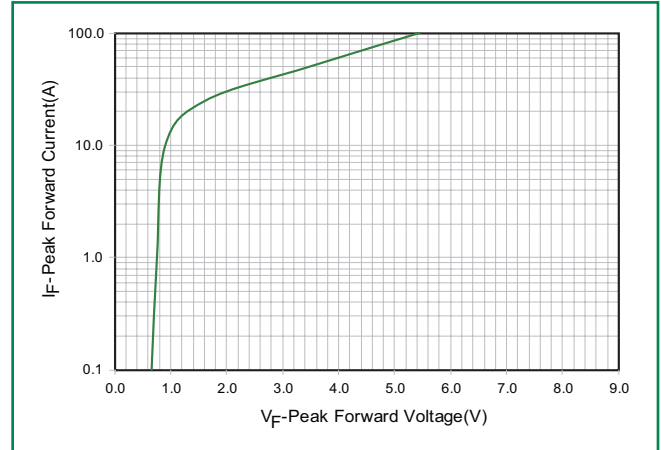
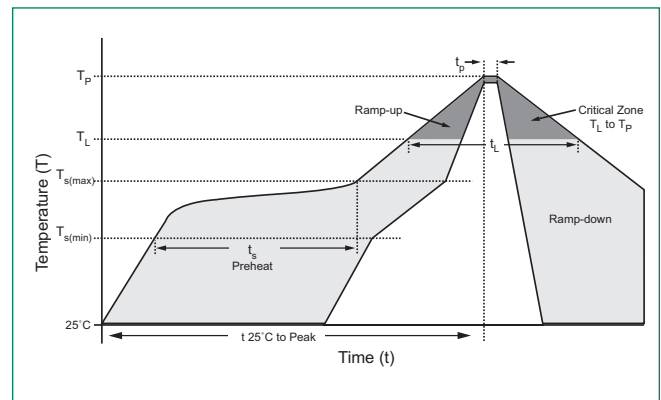

Figure 8 - Peak Forward Voltage Drop vs Peak Forward Current (Typical Values)



Soldering Parameters

| | | |
|--|------------------------------------|------------------|
| Reflow Condition | Lead-free assembly | |
| Pre Heat | - Temperature Min ($T_{s(min)}$) | 150°C |
| | - Temperature Max ($T_{s(max)}$) | 200°C |
| | - Time (min to max) (t_s) | 60 – 180 secs |
| Average ramp up rate (Liquidus Temp (T_A) to peak) | 3°C/second max | |
| $T_{s(max)}$ to T_A - Ramp-up Rate | 3°C/second max | |
| Reflow | - Temperature (T_A) (Liquidus) | 217°C |
| | - Time (min to max) (t_s) | 60 – 150 seconds |
| Peak Temperature (T_p) | 260 ^{+0/-5} °C | |
| Time within 5°C of actual peak Temperature (t_p) | 20 – 40 seconds | |
| Ramp-down Rate | 6°C/second max | |
| Time 25°C to peak Temperature (T_p) | 8 minutes Max. | |
| Do not exceed | 260°C | |



Flow/Wave Soldering (Solder Dipping)

| | |
|---------------------------|------------|
| Peak Temperature : | 265°C |
| Dipping Time : | 10 seconds |
| Soldering : | 1 time |

Physical Specifications

| | |
|-----------------|--|
| Weight | 0.045oz., 1.2g |
| Case | JEDEC DO-201 molded plastic body over passivated junction. |
| Polarity | Color band denotes the cathode except Bipolar. |
| Terminal | Matte Tin axial leads, solderable per JESD22-B102. |

Environmental Specifications

| | |
|----------------------------|-------------|
| High Temp. Storage | JESD22-A103 |
| HTRB | JESD22-A108 |
| Temperature Cycling | JESD22-A104 |
| H3TRB | JESD22-A101 |
| RSH | JESD22-B106 |

Dimensions

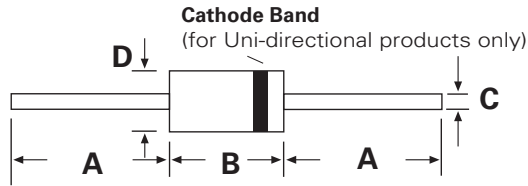

| Dimensions | Inches | | Millimeters | |
|------------|--------|-------|-------------|------|
| | Min | Max | Min | Max |
| A | 1.000 | - | 25.40 | - |
| B | 0.285 | 0.375 | 7.20 | 9.50 |
| C | 0.038 | 0.042 | 0.96 | 1.07 |
| D | 0.190 | 0.210 | 4.80 | 5.30 |

Part Numbering System

TP1.5KE xxx XX

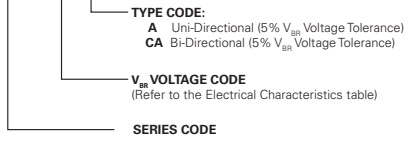

Part Marking System

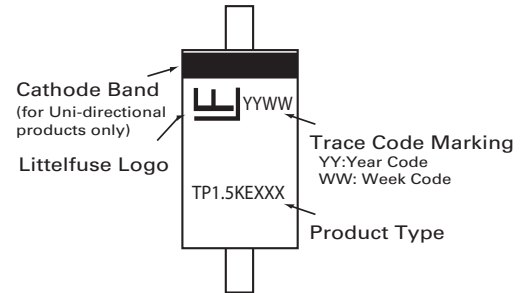

Packaging

| Part Number | Component Package | Quantity | Packaging Option | Packaging Specification |
|--------------|-------------------|----------|------------------|-------------------------|
| TP1.5KExxxXX | DO-201 | 1200 | Tape & Reel | EIA STD RS-296 |

Tape and Reel Specification

