

## Features

- Supply Voltage: 4.5V to 36V
- Rail to Rail Output
- Bandwidth: 6 MHz
- Slew Rate: 20V/μs
- Excellent EMI Suppress Performance
- Offset Voltage: ±100μV Maximum
- Offset Voltage Temperature Drift: 2 μV/°C
- Low Noise: 25 nV/√Hz at 1kHz
- -40°C to 125°C Operation Temperature Range

## Applications

- Instrumentation
- Active Filters, ASIC Input or Output Amplifier
- Sensor Interface
- Motor Control
- Industrial Control

## Description

The TP17 is newest high supply voltage amplifiers with low offset, low power and stable high frequency response. It incorporates 3PEAK's proprietary and patented design techniques to achieve very good AC performance with 6MHz bandwidth, 20V/μs slew rate and low distortion while drawing only 1500μA of quiescent current per amplifier. The input common-mode voltage range extends to V-, and the outputs swing rail-to-rail. The TP17 family can be used as plug-in replacements for many commercially available op-amps to reduce power and improve input/output range and performance.

The combination of features makes the TP17 ideal choices for industrial control, instrumentation.

## Pin Configuration

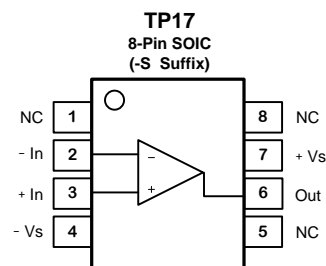

## Table of Contents

Features .....	1
Applications .....	1
Description .....	1
Pin Configuration .....	1
Table of Contents .....	2
Revision History .....	3
Order Information .....	3
Absolute Maximum Ratings <sup>Note 1</sup> .....	4
ESD Rating .....	4
Thermal Information .....	4
Electrical Characteristics .....	5
Typical Performance Characteristics .....	7
Tape and Reel Information .....	11
Package Outline Dimensions .....	12
SOIC-8 .....	12
IMPORTANT NOTICE AND DISCLAIMER .....	13

## Revision History

Date	Revision	Notes
2018/4/21	Rev.Pre	Pre-Release Version
2018/10/5	Rev.0	Initial Vesion

## Order Information

Order Number	Operating Temperature Range	Package	Marking Information	MSL	Transport Media, Quantity
TP17-SR	-40 to 125°C	8-Pin SOIC	TP17 XXXX <small>Note 1</small>	3	Tape and Reel, 4000

Note 1: XXXX identify the manufacture information.

## Absolute Maximum Ratings <sup>Note 1</sup>

Parameters	Rating
Supply Voltage, (+V <sub>S</sub> )– (-V <sub>S</sub> )	40 V
Input Voltage	(-V <sub>S</sub> ) – 0.3 to (+V <sub>S</sub> ) + 0.3
Differential Input Voltage	(+V <sub>S</sub> ) - (-V <sub>S</sub> )
Input Current: +IN, –IN <sup>Note 2</sup>	±10mA
Output Short-Circuit Duration <sup>Note 3</sup>	Infinite
Maximum Junction Temperature	150°C
Operating Temperature Range	–40 to 125°C
Storage Temperature Range	–65 to 150°C
Lead Temperature (Soldering, 10 sec)	260°C

Note 1: Stresses beyond those listed under Absolute Maximum Ratings may cause permanent damage to the device. Exposure to any Absolute Maximum Rating condition for extended periods may affect device reliability and lifetime.

Note 2: The inputs are protected by ESD protection diodes to each power supply. If the input extends more than 300mV beyond the power supply, the input current should be limited to less than 10mA.

Note 3: A heat sink may be required to keep the junction temperature below the absolute maximum. This depends on the power supply voltage and how many amplifiers are shorted. Thermal resistance varies with the amount of PC board metal connected to the package. The specified values are for short traces connected to the leads.

## ESD Rating

Symbol	Parameter	Condition	Minimum Level	Unit
HBM	Human Body Model ESD	ANSI/ESDA/JEDEC JS-001	2	kV
CDM	Charged Device Model ESD	ANSI/ESDA/JEDEC JS-002	1	kV

## Thermal Information

Package Type	θ <sub>JA</sub>	θ <sub>JC</sub>	Unit
8-Pin SOIC	158	43	°C/W

## Electrical Characteristics

All test condition is  $V_S = 30V$ ,  $T_A = 25^\circ C$ ,  $R_L = 10k\Omega$ , unless otherwise noted.

Symbol	Parameter	Conditions	$T_A$	Min	Typ	Max	Unit
<b>Power Supply</b>							
$V_S$	Supply Voltage Range			4.5		36	V
$I_Q$	Quiescent Current per Amplifier	$V_S = 30V$			1.5	2	mA
			-40°C to 125°C			3	mA
PSRR	Power Supply Rejection Ratio	$V_S = 4.5V$ to 36V		105	130		dB
			-40°C to 125°C	100			dB
<b>Input Characteristics</b>							
$V_{OS}$	Input Offset Voltage	$V_S = 30V$ , $V_{CM} = 15V$		-100	50	100	μV
			-40°C to 85°C	-400		400	μV
			-40°C to 125°C	-600		600	μV
		$V_S = 25V$ , $V_{CM} = 12.5V$		-100	50	100	μV
			-40°C to 85°C	-400		400	μV
			-40°C to 125°C	-600		600	μV
		$V_S = 5V$ , $V_{CM} = 2.5V$		-150	50	150	μV
			-40°C to 85°C	-500		500	μV
			-40°C to 125°C	-600		600	μV
$V_{OS\ TC}$	Input Offset Voltage Drift		-40°C to 125°C		1		μV/°C
$I_B$	Input Bias Current				25		pA
			-40°C to 85°C		80		pA
			-40°C to 125°C		1000		pA
$I_{OS}$	Input Offset Current				25		pA
$I_{IN}$	Different Input Current	$V_S = 36V$ , $V_{ID} = 36V$			10	100	nA
			-40°C to 125°C			100	300
$C_{IN}$	Input Capacitance	Differential Mode			5		pF
		Common Mode			2.5		pF
$A_V$	Open-loop Voltage Gain	$V_S = 30V$ , $V_{OUT} = 0.5V$ to 29.5V		120	130		dB
			-40°C to 125°C	105			dB
$V_{CMR}$	Common-mode Input Voltage Range			(V-)		(V+) - 1.5	V
CMRR	Common Mode Rejection Ratio	$V_{CM} = 0.5V$ to 28.5V		100	125		dB
			-40°C to 125°C	95			dB

Output Characteristics								
V <sub>OH</sub>	Output Swing from Positive Rail	R <sub>LOAD</sub> = 100kΩ to V <sub>S</sub> /2			5	15	mV	
			-40°C to 85°C				30	mV
			-40°C to 125°C				40	mV
		R <sub>LOAD</sub> = 10kΩ to V <sub>S</sub> /2			50	80	mV	
			-40°C to 85°C				120	mV
			-40°C to 125°C				130	mV
V <sub>OL</sub>	Output Swing from Negative Rail	R <sub>LOAD</sub> = 100kΩ to V <sub>S</sub> /2			5	10	mV	
			-40°C to 85°C				20	mV
			-40°C to 125°C				25	mV
		R <sub>LOAD</sub> = 10kΩ to V <sub>S</sub> /2			40	50	mV	
			-40°C to 85°C				80	mV
			-40°C to 125°C				100	mV
I <sub>SC</sub>	Output Short-Circuit Current	Source Current		20	32		mA	
		Sink Current		15	25		mA	
AC Specifications								
GBW	Gain-Bandwidth Product				6		MHz	
SR	Slew Rate	G = 1, 10V step		13	20		V/μs	
			-40°C to 125°C	10			V/μs	
t <sub>OR</sub>	Overload Recovery				100		ns	
t <sub>S</sub>	Settling Time, 0.1%	G = -1, 10V step			0.5		μs	
	Settling Time, 0.01%				0.8		μs	
PM	Phase Margin	V <sub>S</sub> = 36V, R <sub>L</sub> =10K, C <sub>L</sub> =100pF			60		°	
GM	Gain Margin	V <sub>S</sub> = 36V, R <sub>L</sub> =10K, C <sub>L</sub> =100pF			10		dB	
Noise Performance								
E <sub>N</sub>	Input Voltage Noise	f = 0.1Hz to 10Hz			2		μV <sub>RMS</sub>	
e <sub>N</sub>	Input Voltage Noise Density	f = 1kHz			25		nV/√Hz	
i <sub>N</sub>	Input Current Noise	f = 1kHz			2		fA/√Hz	
THD+N	Total Harmonic Distortion and Noise	f = 1kHz, G = 1, R <sub>L</sub> = 10kΩ, V <sub>OUT</sub> = 6V <sub>RMS</sub>			0.0005		%	
Thermal Shutdown								
	Thermal Shutdown temperature				170		°C	
	Recover Temperature				150		°C	

### Typical Performance Characteristics

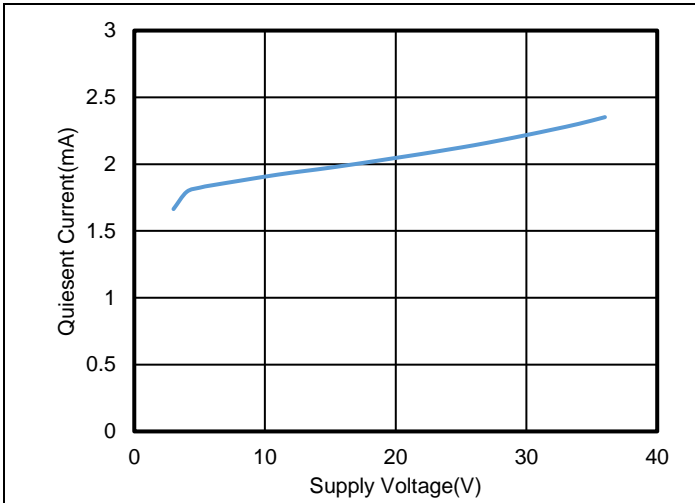

Figure 1. Quiescent Current vs. Supply Voltage, TP1282L1

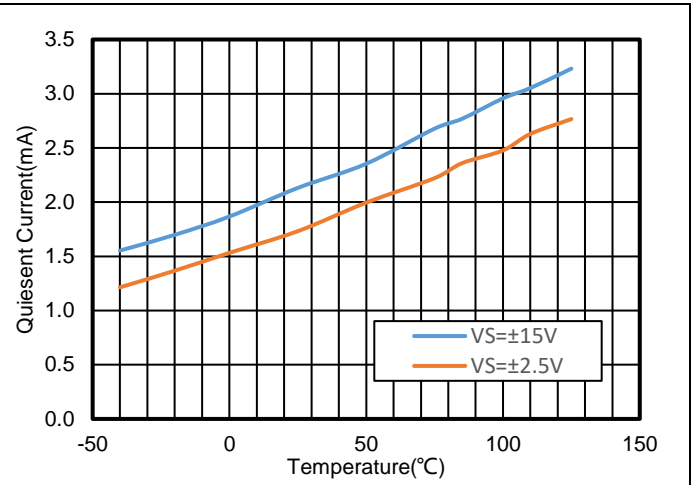

Figure 2. Quiescent Current vs. Temperature, TP1282L1

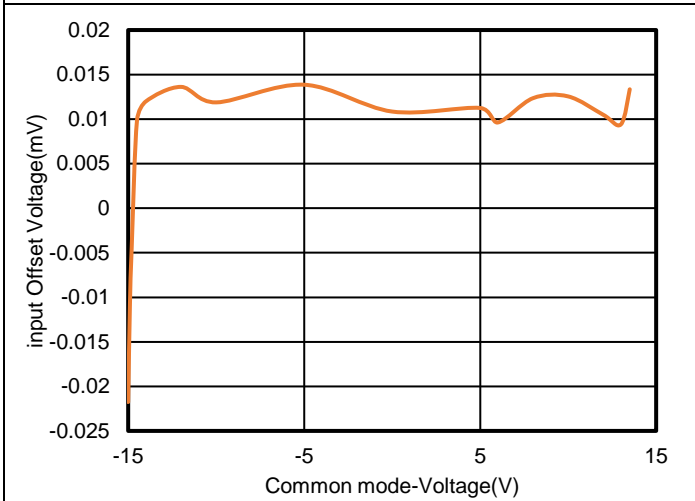

Figure 3. Offset Voltage vs. Common Mode Voltage

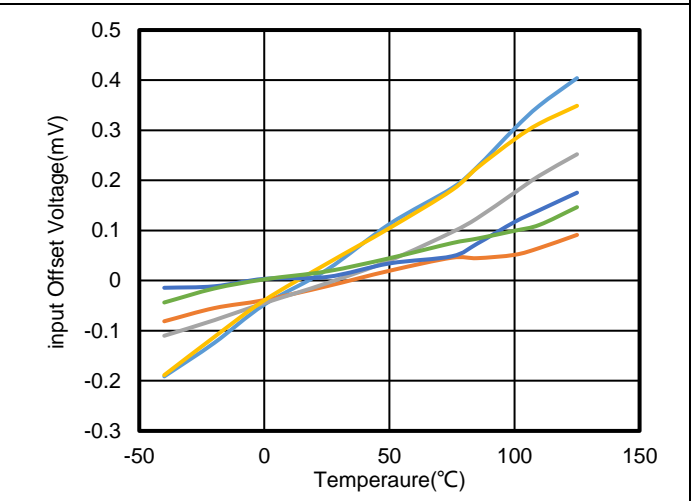

Figure 4. Vos vs. Temperature

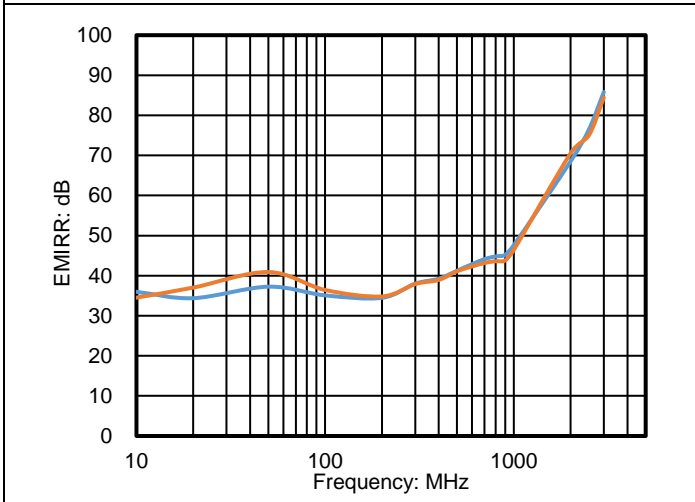

Figure 5. EMIRR vs. Frequency

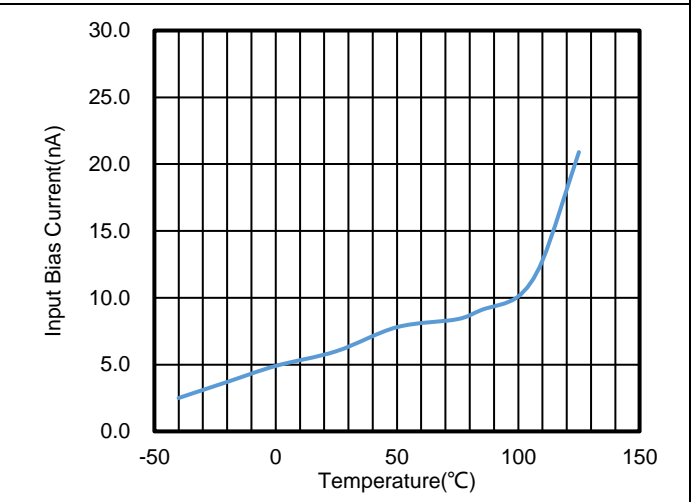
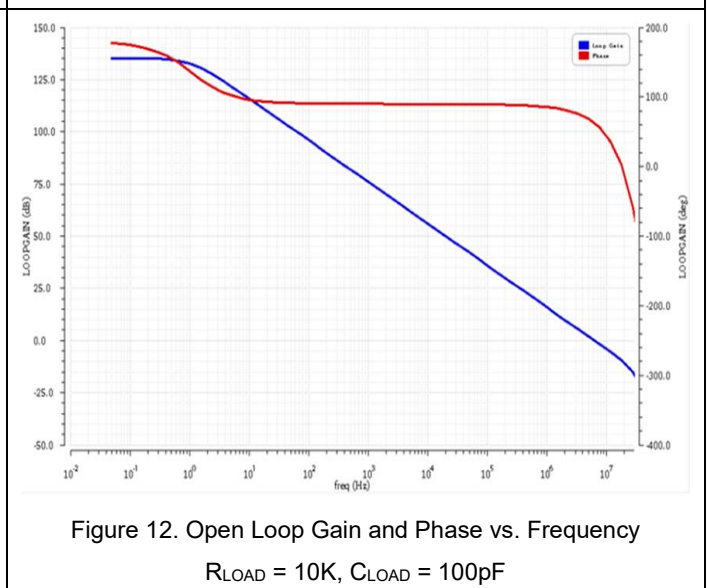
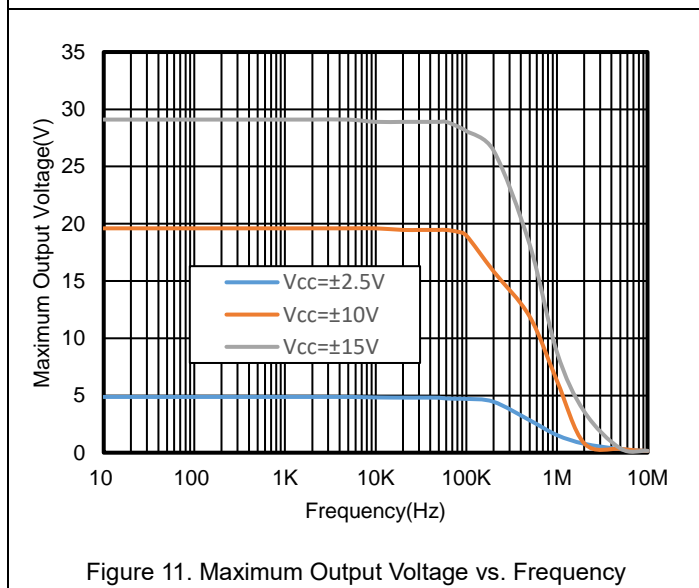
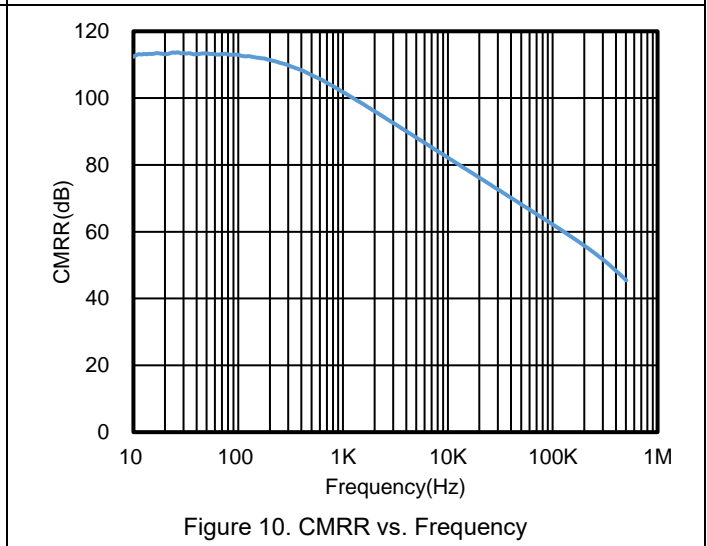
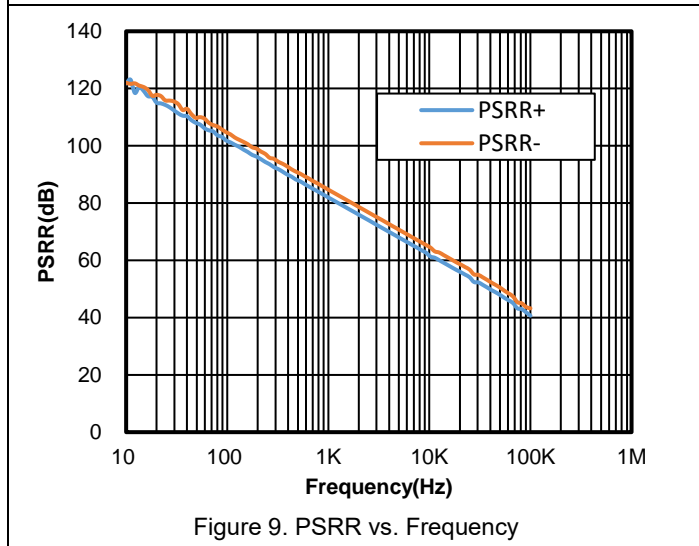
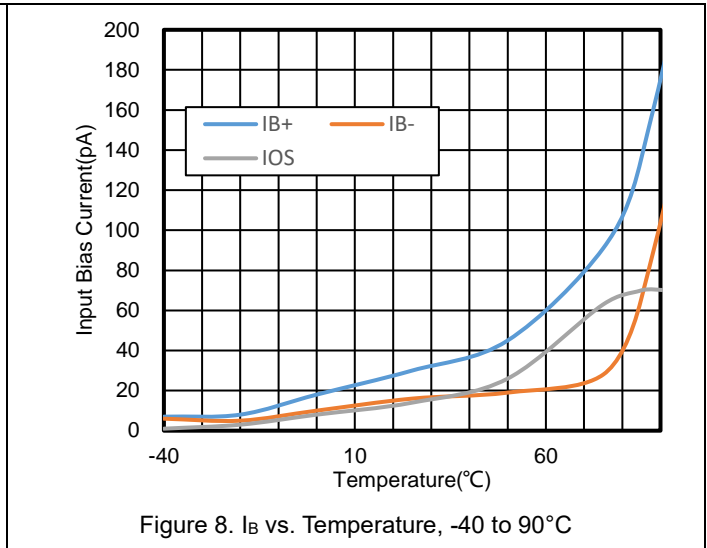
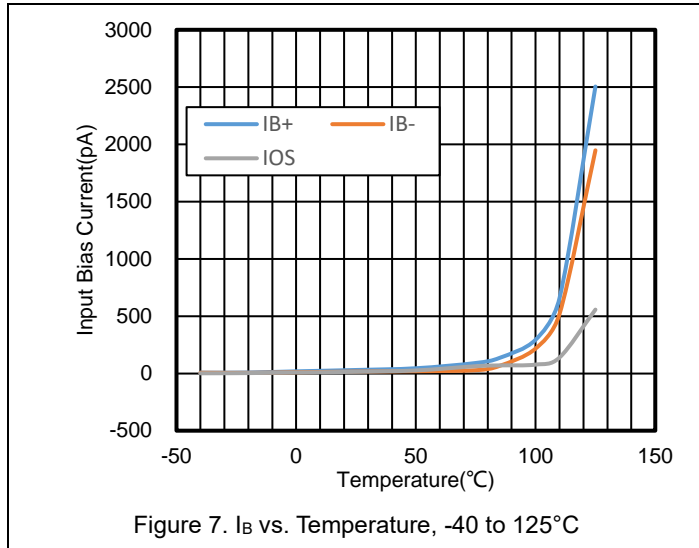

Figure 6. Input Current in Large Vdm vs. Temperature

$V_s = \pm 15V$ ,  $V_{CM} = 0V$ ,  $R_L = 10k\Omega$ , unless otherwise specified.





$V_s = \pm 15V$ ,  $V_{CM} = 0V$ ,  $R_L = 10k\Omega$ , unless otherwise specified.

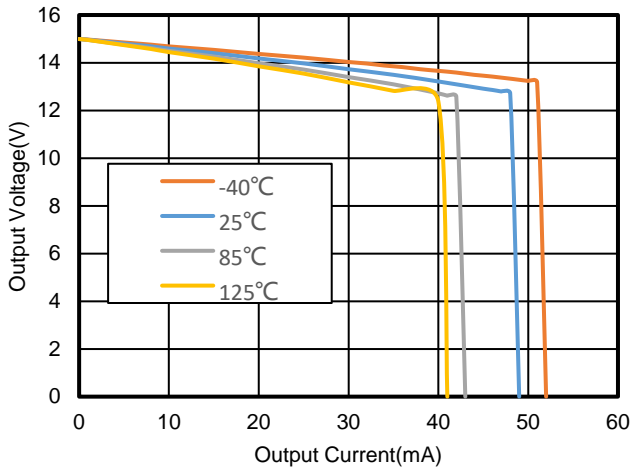

Figure 13. Positive Output Voltage vs. Output Current

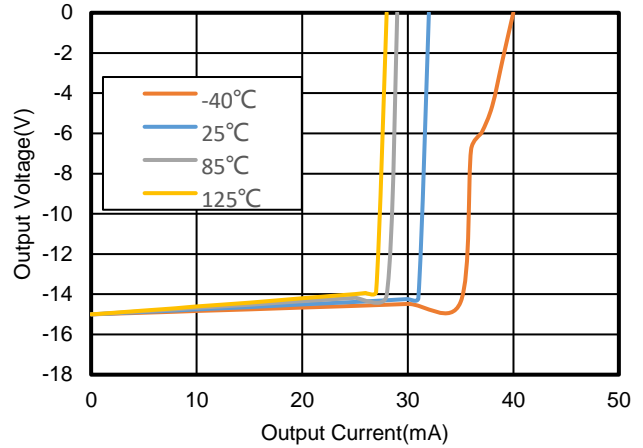
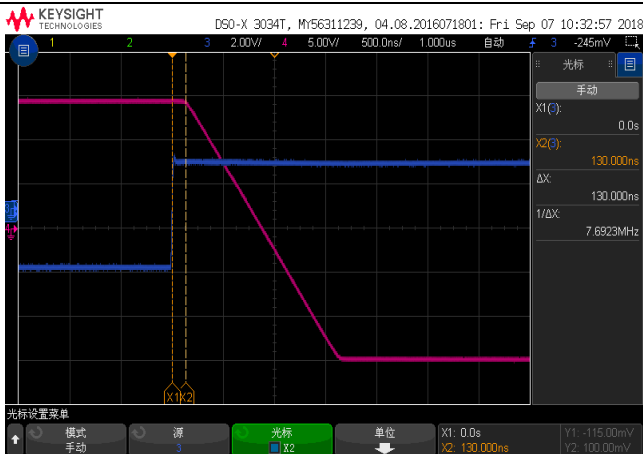
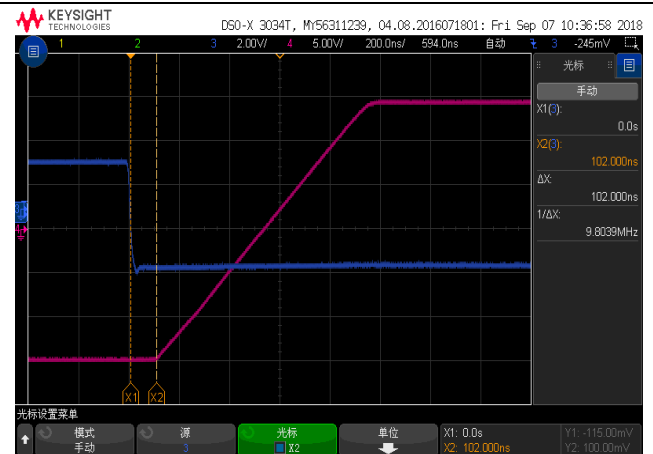

Figure 14. Negative Output Voltage vs. Output Current



Voltage: 5V/div for Output, Time: 500ns/div  
G=-10, VREF = GND; VIN=5VPP, Load R=2K C=100pF

Figure 15. Positive Overload Recovery



Voltage: 5V/div for Output, Time: 500ns/div  
G=-10, VREF = GND; VIN=5VPP, Load R=2K C=100pF

Figure 16. Negative Overload Recovery



Voltage: 50mV/div, Time: 1μs/div  
 $R_L=2K$ ,  $C_L=100pF$ , G=1

Figure 17. 100mV Signal Step Response



Voltage: 5V/div, Time: 1μs/div  
 $R_L=2K$ ,  $C_L=100pF$ , G=1

Figure 18. 10V Signal Step Response

$V_s = \pm 15V$ ,  $V_{CM} = 0V$ ,  $R_L = 10k\Omega$ , unless otherwise specified.

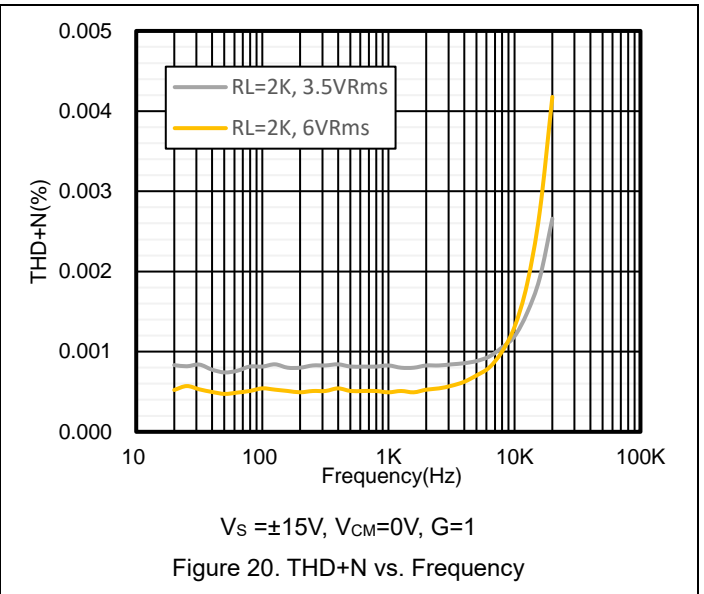
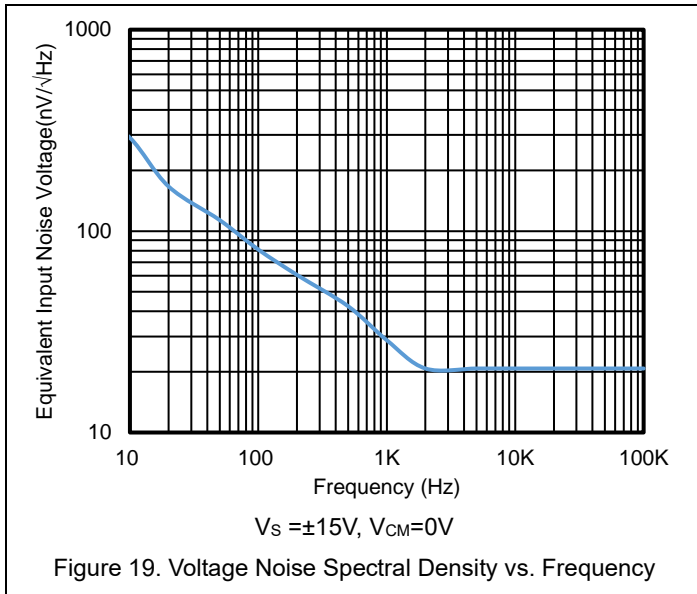

**Tape and Reel Information**

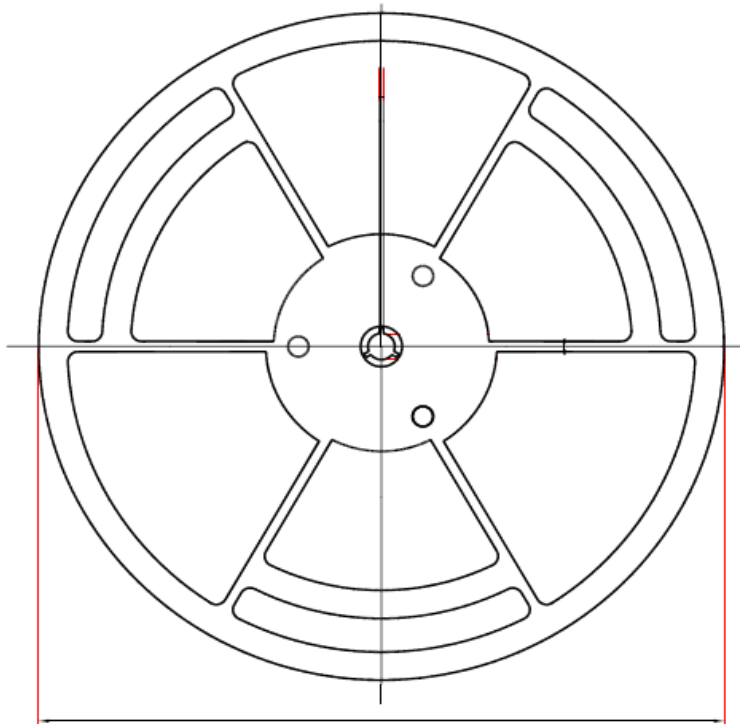

D1: Reel Diameter

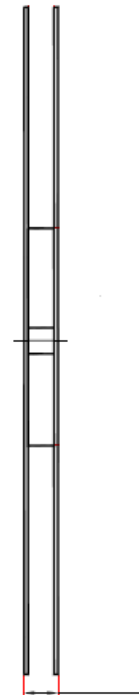

W1: Reel Width

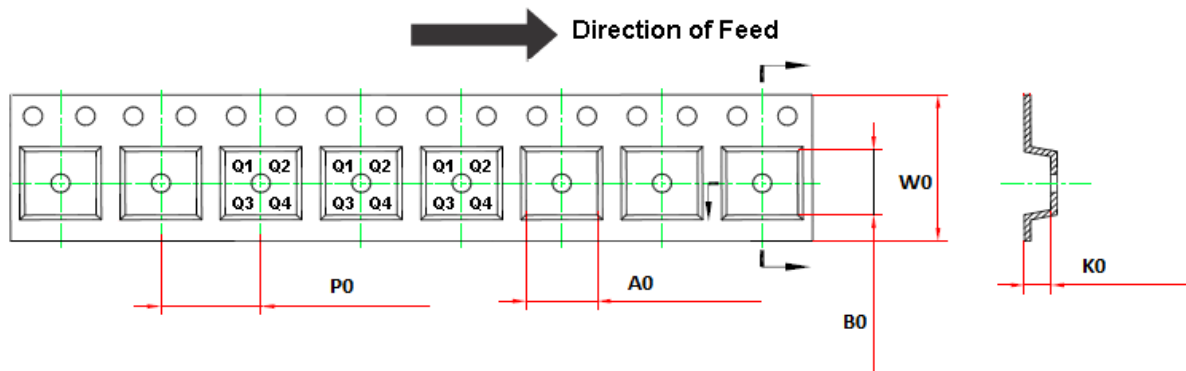

Order Number	Package	D1	W1	A0	B0	K0	P0	W0	Pin1 Quadrant
TP17-SR	8-Pin SOIC	330.0	17.6	6.4	5.4	2.1	8.0	12.0	Q1

Package Outline Dimensions

SOIC-8

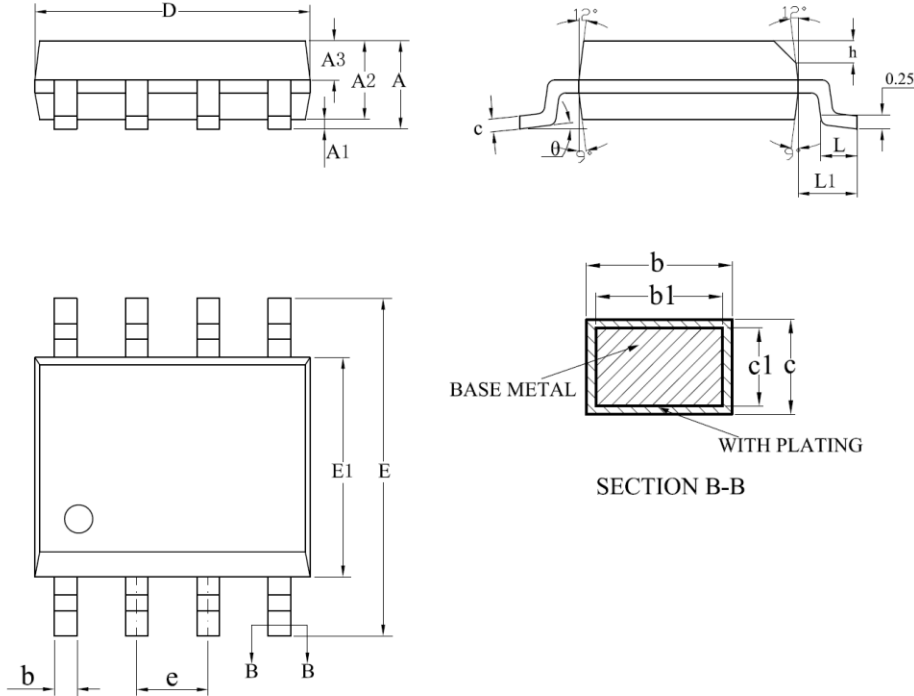

SYMBOL	MILLIMETER		
	MIN	NOM	MAX
A	—	—	1.75
A1	0.10	—	0.225
A2	1.30	1.40	1.50
A3	0.60	0.65	0.70
b	0.39	—	0.47
b1	0.38	0.41	0.44
c	0.20	—	0.24
c1	0.19	0.20	0.21
D	4.80	4.90	5.00
E	5.80	6.00	6.20
E1	3.80	3.90	4.00
e	1.27BSC		
h	0.25	—	0.50
L	0.50	—	0.80
L1	1.05REF		
$\theta$	0	—	8°

## IMPORTANT NOTICE AND DISCLAIMER

**Copyright**© 3PEAK 2012-2023. All rights reserved.

**Trademarks.** Any of the 思瑞浦 or 3PEAK trade names, trademarks, graphic marks, and domain names contained in this document /material are the property of 3PEAK. You may NOT reproduce, modify, publish, transmit or distribute any Trademark without the prior written consent of 3PEAK.

**Performance Information.** Performance tests or performance range contained in this document/material are either results of design simulation or actual tests conducted under designated testing environment. Any variation in testing environment or simulation environment, including but not limited to testing method, testing process or testing temperature, may affect actual performance of the product.

**Disclaimer.** 3PEAK provides technical and reliability data (including data sheets), design resources (including reference designs), application or other design recommendations, networking tools, security information and other resources "As Is". 3PEAK makes no warranty as to the absence of defects, and makes no warranties of any kind, express or implied, including without limitation, implied warranties as to merchantability, fitness for a particular purpose or non-infringement of any third-party's intellectual property rights. Unless otherwise specified in writing, products supplied by 3PEAK are not designed to be used in any life-threatening scenarios, including critical medical applications, automotive safety-critical systems, aviation, aerospace, or any situations where failure could result in bodily harm, loss of life, or significant property damage. 3PEAK disclaims all liability for any such unauthorized use.