



COLOR MONITOR

TP17LT

SERVICE *Manual*

COLOR MONITOR



CONTENTS

1. Precautions
2. Product Specifications
3. Disassembly & Reassembly
4. Alignment & Adjustments
5. Troubleshooting
6. Exploded View & Parts List
7. Electrical Parts List
8. Block Diagram
9. Wiring Diagram
10. Schematic Diagrams



Samsung Electronics Co., Ltd. March 2000.
Printed in Korea
P/N : BH68-00129K-01

1 Precautions

1-1 Safety Precautions

WARNINGS

1. For continued safety, do not attempt to modify the circuit board.
2. Disconnect the AC power before servicing.
3. When the chassis is operating, semiconductor heatsinks are potential shock hazards.

1-1-1 Servicing the High Voltage and CRT :

WARNING:A high voltage adjusted to the wrong value may cause excessive X-ray emissions.

1. When servicing the high voltage system, remove the static charge by connecting a 10 kohm resistor in series with an insulated wire (such as a test probe) between the chassis and the anode lead.
2. When troubleshooting a monitor with excessively HV, avoid being unnecessarily close to the monitor. Do not operate the monitor for longer than is necessary to locate the cause of excessive voltage.
3. High voltage should always be kept at the rated value, no higher. Only when high voltage is excessive are X-rays capable of penetrating the shell of the CRT, including the lead in glass material. Operation at high voltages may also cause failure of the CRT or high voltage circuitry.
4. When the HV regulator is operating properly, there is no possibility of an X-ray problem. Make sure the HV does not exceed its specified value and that it is regulating correctly.
5. The CRT is especially designed to prohibit X-ray emissions. To ensure continued X-ray protection, replace the CRT only with one that is the same or equivalent type as the original.
6. Handle the CRT only when wearing shatterproof goggles and after completely discharging the high voltage anode.
7. Do not lift the CRT by the neck.

1-1-2 Fire and Shock Hazard :

Before returning the monitor to the user, perform the following safety checks:

1. Inspect each lead dress to make certain that the leads are not pinched or that hardware is not lodged between the chassis and other metal parts in the monitor.
2. Inspect all protective devices such as nonmetallic control knobs, insulating materials, cabinet backs, adjustment and compartment covers or shields, isolation resistor-capacitor networks, mechanical insulators, etc.

3. Leakage Current Hot Check (Figure 1-1):
WARNING: Do not use an isolation transformer during this test.

Use a leakage current tester or a metering system that complies with American National Standards Institute (*ANSI C101.1, Leakage Current for Appliances*), and Underwriters Laboratories (*UL Publication UL1410, 59.7*).

4. With the unit completely reassembled, plug the AC line cord directly into a 120V AC outlet. With the unit's AC switch first in the ON position and then OFF, measure the current between a known earth ground (metal water pipe, conduit, etc.) and all exposed metal parts, including: metal cabinets, screwheads and control shafts. The current measured should not exceed 0.5 milliamp. Reverse the power-plug prongs in the AC outlet and repeat the test.

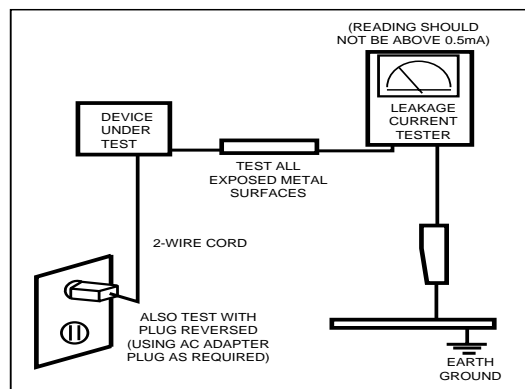

Figure 1-1. Leakage Current Test Circuit

1-1-4 Product Safety Notices

Some electrical and mechanical parts have special safety-related characteristics which are often not evident from visual inspection. The protection they give may not be obtained by replacing them with components rated for higher voltage, wattage, etc. Parts that have special safety characteristics are identified by \triangle on schematics and parts lists. A substitute replacement that does not have the same safety characteristics as the recommended replacement part might create shock, fire and / or other hazards. Product safety is under review continuously and new instructions are issued whenever appropriate.

Components identified by \odot on schematics and parts lists must be sealed by a soldering iron after replacement and adjustment.

1-2 Servicing Precautions

WARNING1: First read the “Safety Precautions” section of this manual. If unforeseen circumstances create conflict between the servicing precautions and safety precautions, always follow the safety precautions.

WARNING2: A high voltage adjusted to the wrong value may cause excessive X-ray emissions.

WARNING3: An electrolytic capacitor installed with the wrong polarity might explode.

1. Servicing precautions are printed on the cabinet, and should be followed closely.
2. Always unplug the unit’s AC power cord from the AC power source before attempting to: (a) remove or reinstall any component or assembly, (b) disconnect PCB plugs or connectors, (c) connect all test components in parallel with an electrolytic capacitor.
3. Some components are raised above the printed circuit board for safety. An insulation tube or tape is sometimes used. The internal wiring is sometimes clamped to prevent contact with thermally hot components. Reinstall all such elements to their original position.
4. After servicing, always check that the screws, components and wiring have been correctly reinstalled. Make sure that the area around the serviced part has not been damaged.
5. Check the insulation between the blades of the AC plug and accessible conductive parts (examples: metal panels, input terminals and earphone jacks).
6. Insulation Checking Procedure: Disconnect the power cord from the AC source and turn the power switch ON. Connect an insulation resistance meter (500 V) to the blades of the AC plug.
The insulation resistance between each blade of the AC plug and accessible conductive parts (see above) should be greater than 1 megohm.
7. Never defeat any of the +B voltage interlocks. Do not apply AC power to the unit (or any of its assemblies) unless all solid-state heat sinks are correctly installed.
8. Always connect a test instrument’s ground lead to the instrument chassis ground *before* connecting the positive lead; always remove the instrument’s ground lead last.

1-3 Electrostatically Sensitive Devices (ESD) Precautions

Some semiconductor (solid state) devices can be easily damaged by static electricity. Such components are commonly called Electrostatically Sensitive Devices (ESD). Examples of typical ESD devices are integrated circuits and some field-effect transistors. The following techniques will reduce the incidence of component damage caused by static electricity.

1. Immediately before handling any semiconductor components or assemblies, drain the electrostatic charge from your body by touching a known earth ground. Alternatively, wear a discharging wrist-strap device. To avoid a shock hazard, be sure to remove the wrist strap before applying power to the monitor.
2. After removing an ESD-equipped assembly, place it on a conductive surface such as aluminum foil to prevent accumulation of an electrostatic charge.
3. Do not use freon-propelled chemicals. These can generate electrical charges sufficient to damage ESDs.
4. Use only a grounded-tip soldering iron to solder or desolder ESDs.
5. Use only an anti-static solder removal device. Some solder removal devices not classified as “anti-static” can generate electrical charges sufficient to damage ESDs.
6. Do not remove a replacement ESD from its protective package until you are ready to install it. Most replacement ESDs are packaged with leads that are electrically shorted together by conductive foam, aluminum foil or other conductive materials.
7. Immediately before removing the protective material from the leads of a replacement ESD, touch the protective material to the chassis or circuit assembly into which the device will be installed.
Caution: Be sure no power is applied to the chassis or circuit and observe all other safety precautions.
8. Minimize body motions when handling unpackaged replacement ESDs. Motions such as brushing clothes together, or lifting your foot from a carpeted floor can generate enough static electricity to damage an ESD.
9.  Indicates ESDs on the Schematic Diagram in this manual.

2 Product Specifications

2-1 Specifications

Item	Description
Picture Tube:	17-Inch (43 cm): 16-inch (40.6 cm) viewable, Full-square flat-face tube, 90° Deflection, Silica coated with anti-electronic properties (TCO: Multilayer coating) Medium-short persistence phosphor, 0.24 mm (H) / 0.14 mm (V) Dot pitch
Scanning Frequency	Horizontal : 30 kHz to 70 kHz (Automatic) Vertical : 50 Hz to 160 Hz (Automatic)
Display Colors	Unlimited colors
Maximum Resolution	Horizontal : 1280 Dots Vertical : 1024 Lines
Input Video Signal	Analog, 0.7 Vp-p positive at 75 Ω , internally terminated
Input Sync Signal	Separate Sync: TTL level positive/negative
Maximum Pixel Clock rate	110 MHz
Active Display	Horizontal : 306 mm \pm 4 mm / Vertical : 230.5 mm \pm 4 mm
Input Voltage	AC 90 to 264 Volts, 60 Hz or 50 Hz \pm 3 Hz
Power Consumption	90 Watt (max)
Dimensions	Unit (Without Speakers) ; 16.53 x 16.88 x 15.86 Inches (420 x 429 x 403 mm) (With Speakers) ; 20.19 x 16.88 x 15.86 Inches (513x 429 x 403 mm) Carton ; 21.02 x 21.73 x 21.02 Inches (534 x 552 x 534 mm)
Weight	Without Speakers : 35.3 lbs (16.0 kg) / With Speakers : 37.5 lbs (17.0kg) / Carton : 44.1 lbs (20.0kg)
Environmental Considerations	Operating Temperature : 32°F to 104°F (0°C to 40°C) Humidity : 10 % to 80 % Storage Temperature : -4°F to 113°F (-20°C to 45°C) Humidity : 5 % to 95 %
<ul style="list-style-type: none"> • Above model comply with SWEDAC (MPR II) recommendations for reduced electromagnetic fields. • Designs and specifications are subject to change without prior notice. 	

2-2 Pin Assignments

Pin No. \ Sync Type	Separate	Macintosh
1	Red	GND-R
2	Green	Red
3	Blue	H/V Sync
4	N-C	Sense 0
5	DDC Return	Green
6	GND-R	GND-G
7	GND-G	Sense 1
8	GND-B	Reserved
9	N-C	Blue
10	GND-Sync/Self-raster	Sense 2
11	N-C	GND
12	DDC Data	V-Sync
13	H-Sync	GND-B
14	V-Sync	GND
15	DDC Clock	H-Sync

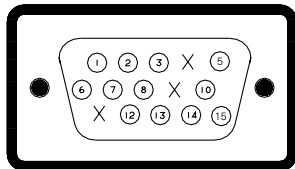

Figure 2-1. Male Type

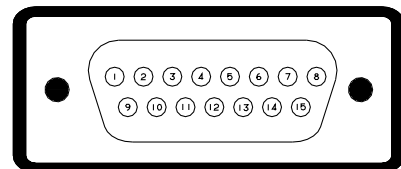

Figure 2-2. Male Type

2-3 Timing Chart

This section of the service manual describes the timing that the computer industry recognizes as standard for computer-generated video signals.

Table 2-1. Timing Chart

Mode Timing	IBM		VESA					
	VGA2/70 Hz 720 x 400	VGA3/60 Hz 640 x 480	640/75 Hz 640 x 480	640/85 Hz 640 x 480	800/75 Hz 800 x 600	800/85 Hz 800 x 600	1024/75 Hz 1024 x 768	1024/85 Hz 1024 x 768
fH (kHz)	31.469	31.469	37.500	43.269	46.875	53.674	60.023	68.677
A μ sec	31.777	31.778	26.667	23.111	21.333	18.631	16.660	14.561
B μ sec	3.813	3.813	2.032	1.556	1.616	1.138	1.219	1.016
C μ sec	1.907	1.907	3.810	2.222	3.232	2.702	2.235	2.201
D μ sec	25.422	25.422	20.317	17.778	16.162	14.222	13.003	10.836
E μ sec	0.636	0.636	0.508	1.556	0.323	0.569	0.203	0.508
fV (Hz)	70.087	59.940	75.000	85.008	75.000	85.061	75.029	84.997
O msec	14.268	16.683	13.333	11.764	13.333	11.756	13.328	11.765
P msec	0.064	0.064	0.080	0.671	0.064	0.056	0.050	0.044
Q msec	1.080	1.048	0.427	0.578	0.448	0.503	0.466	0.524
R msec	12.711	15.253	12.800	11.093	12.800	11.179	12.795	11.183
S msec	0.413	0.318	0.027	0.023	0.021	0.019	0.017	0.015
Clock Frequency (MHz)	28.322	25.175	31.500	36.000	49.500	56.250	78.750	94.500
Polarity H.Sync	Negative	Negative	Negative	Negative	Positive	Positive	Positive	Positive
V.Sync	Positive	Negative	Negative	Negative	Positive	Positive	Positive	Positive
Remark	Separate	Separate	Separate	Separate	Separate	Separate	Separate	Separate

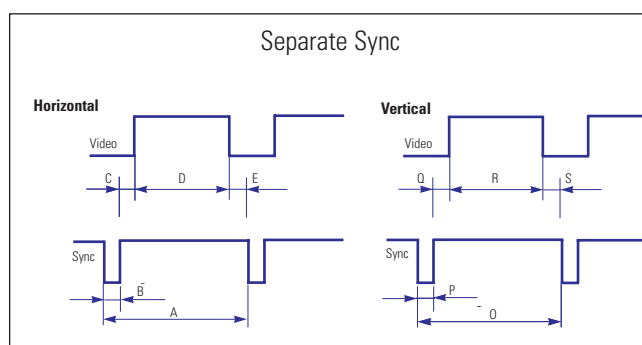

A : Line time total	B : Horizontal sync width	O : Frame time total	P : Vertical sync width
C : Back porch	D : Active time	Q : Back porch	R : Active time
E : Front porch		S : Front porch	

Memo

3 Disassembly and Reassembly

This section of the service manual describes the disassembly and reassembly procedures for the TP17LT monitor.

WARNING: This monitor contains electrostatically sensitive devices. Use caution when handling these components.

3-1 Disassembly

- Cautions:**
1. Disconnect the monitor from the power source before disassembly.
 2. To remove the Rear Cover, you must use the special opening jig tool.

3-1-1 Cabinet Disassembly

1. With a pad beneath it, stand the monitor on its front with the screen facing downward and the base closest to you. Make sure nothing will damage the screen.
2. Remove the Stand from the monitor. (Refer to Stand manual)
3. Incline the monitor by lifting the rear of the monitor.



Figure 1

4. Push the Opening jig each groove along the top of the monitor till it makes a “tak” sound. (2 grooves : Left and Right, Make sure each snap is disengaged.)



Figure 2

5. Squeeze the hold-snap on bottom of the monitor using your hand.
6. Insert the Opening jig into the groove then release the hold-snap.
7. When the hold-snap release, lift the Rear Cover slightly to make sure it doesn't re-engage while you release the snap on the other side.
8. In a similar manner, Release the hold-snap on the opposite side.
9. Pull the Rear Cover up off the monitor.
10. Using pinch-nose pliers or ling-nose pliers, acrefully disconnect the Anode Cap from the CRT.

Warning: Do not touch the Anode contact on the CRT (High Voltage may remain).

Note : If the hold-snap on the bottom of the Front Cover is broken, secure the cabinet by applying a 4x16 screw in the extra holes on each side of the cabinet.

3-1-2 Removing the CRT Socket PCB

1. Complete all previous steps.
2. Lift up the Video Spring and remove the CRT Socket PCB from the CRT.

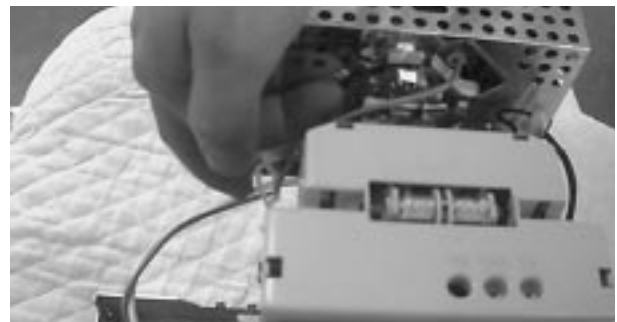

Figure 3

3. Disconnect all connectors on the CRT Socket PCB.
4. Using a solder iron, disconnect Ground (G2) on the back of the Video Shield and remove the Shield Cap.
5. Remove the screw on the front of the Shield Socket.
6. Desolder the 4 tabs on the CRT Socket PCB and remove Shield.
7. Place the Video PCB on a flat, level surface that is protected from static electricity.

3-1-3 Removing the Main PCB

1. Complete all previous steps.
2. Disconnect the Degaussing Coil at GT601 and GT602 on the Main PCB.
3. Disconnect all easily accessible ground wires on the Main PCB and Bottom Chassis.
4. Disconnect the DY connector at the CN303 connector on the Main .
5. Using the jig, release the snaps (2) connecting the Front Cover and Main PCB then lift up the Bottom to separate the two Shield.



Figure 4

6. Remove the screws on the back and along each side of the Bottom Chassis.
7. Carefully lift the Main PCB Ass'y and remove the remaining ground wires.
8. Place the Main PCB Ass'y on a flat, level surface that is protected from static electricity.

3-1-4 CRT Ass'y Disassembly

1. Complete all previous steps.
2. Straighten the Degaussing Coil Assembly coated metal ties and lift the Coil Ass'y from the CRT.
3. Remove the four corner screws and lift the CRT up and away from the Front Cover Assembly and place it on a padded surface.

Caution: Do not lift the CRT by the neck.

If you will be returning this CRT to the monitor, be sure to place the CRT face downward on a protective pad.

3-2 Reassembly

Reassembly procedures are in the reverse order of Disassembly procedures.

4 Alignment and Adjustments

This section of the service manual explains how to make permanent adjustments to the monitor. Directions are given for adjustments using the monitor Interface Board Ver. 2.0 and software (Softjig).

4-1 Adjustment Conditions

Caution: Changes made without the Softjig are saved only to the user mode settings. As such, the settings are not permanently stored and may be inadvertently deleted by the user.

4-1-1 Before Making Adjustments

4-1-1 (a) ORIENTATION

When servicing, always face the monitor to the east.

4-1-1 (b) MAGNETIC FIELDS

Whenever possible, use magnetic field isolation equipment such as a Helmholtz field to surround the monitor. If a Helmholtz field is not available, frequently degauss the unit under test.

Caution: Other electrical equipment may cause external magnetic fields which may interfere with monitor performance.

Use an external degaussing coil to limit magnetic build up on the monitor. If an external degaussing coil is not available, use the internal degaussing circuit. However, do not use the internal degaussing circuit more than once per 30 minutes.

4-1-1 (c) WARM-UP TIME

The monitor must be on for 30 minutes before starting alignment. Warm-up time is especially critical in color temperature and white balance adjustments.

4-1-1 (d) SIGNAL

Analog, 0.7 V_{p-p} positive at 75 ohm, internal termination

Sync: Separate
(TTL level negative/positive)

4-1-1 (e) SCANNING FREQUENCY

Horizontal: 30 kHz to 70 kHz (Automatic)

Vertical: 50 Hz to 160 Hz (Automatic)

Unless otherwise specified, adjust at the 1024 x 768 mode (68 kHz/85 Hz) signals.

Refer to Table 2-1 on page 2-3.

4-1-2 Required Equipment

The following equipment may be necessary for adjustment procedures:

4-1-2 (a) DISPLAY CONTROL ADJUSTMENT

1. Non-metallic (-) screwdriver:
1.5, 2.5, 3 mm
2. Non-metallic (+) screwdriver:
1.5, 2.5, 3 mm
3. Digital Multimeter (DMM), or
Digital Voltmeter
4. Signal generator, or
DM200 software
5. Software: Softjig or DM200
6. Interface Board Ver. 2.0 Code No.
BH81-90001K
7. Parallel communications cable (25-pin to
25-pin); Code No. BH81-90001H
8. Signal cable (15-pin to 15-pin cable with
additional 3-pin connector); Code No.
BH81-90001J
9. 5 V DC adapter, not supplied
10. Personal computer

Note: Softjig Ass'y (includes items 6, 7 and 9)
Code No. BH81-90001L

4-1-2 (b) COLOR ADJUSTMENTS

1. All equipment listed in 4-1-2 (a), above
2. Color analyzer, or any luminance
measurement equipment

4-1-3 Connecting the SoftJig

Connect the monitor to the signal generator and/or PC as illustrated in Figures 4-1 and 4-2.

Note: The signal cable connector which includes the 3-wire cable must connect to the monitor. If you use Setup 2 (PC only, no signal generator) you can only make adjustments to the signal timing available on that computer system. To make corrections to all factory timings requires the use of an additional signal generator.

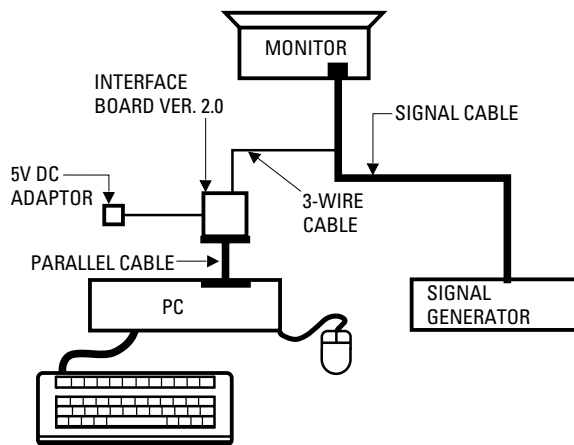

Figure 4-1. Setup 1, With Signal Generator

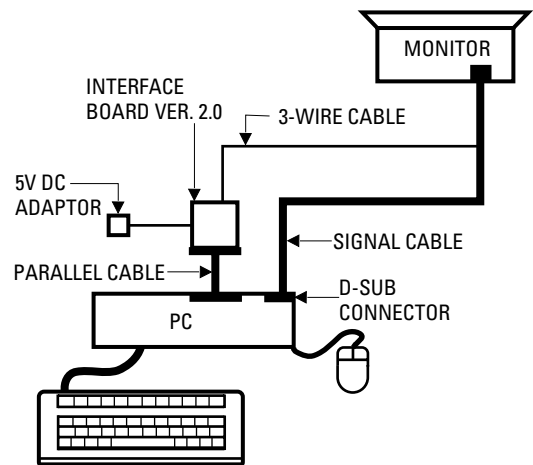

Figure 4-2. Setup 2, Without Signal Generator

4-2 Display Control Adjustments

4-2-1 HIGH VOLTAGE ADJUSTMENT

Signal: 1024 x 768 (68 kHz/85 Hz)
 Display image: Don't care
 Contrast: Minimum
 Brightness: Minimum
 Limit: 26.5 kV \pm 0.2 kV

exception) 26.0 kV \pm 0.2 kV for SDD CRT that the DY type is DMX-1791AT

Measure the high voltage level at the anode cap. High voltage should be within the limit as above. If the high voltage needs adjustment use the following procedure.

PROCEDURE

1. Turn the power off and disconnect the AC line cord from the power source.
2. Turn the power on after connecting high voltage Probe.
3. Using the jig, adjust the high voltage to the specification.

* High Voltage Adjustment PROCEDURE using Softjig

- ① Select matching model name in "Model" field.
- ② Select "@7: Zero Beam" in menu after selecting "Extra 1"
- ③ Adjust high voltage using control bar after selecting "HV MIN"
- ④ Turn the power off/on after adjustment finished.
- ⑤ Check the high voltage has been fixed with adjusted value after reselecting "@7: Zero Beam".

4-2-2 SCREEN VOLTAGE ADJUSTMENT

CONDITIONS

Signal: 1024 x 768 (68 kHz/85 Hz)
 Display image: Don't care
 Contrast: Minimum
 Brightness: Minimum
 Limit: 26.5 kV \pm 0.2 kV

Screen Voltage adjustment procedure using softjig is all the same as 4-2-1 but selecting "G2 CONT" on the contrary to "HV MIN".

Table 4-1

	CRT type	Screen Voltage
17"	M41QAR361X11*(*) M41QAQ261X11*(*) M41LFQ903X28(L), etc	480V \pm 10V
	M41EHN325X160/3F**U M41EHN323X160/3F**U	500V \pm 10V
	M41LLJ507XX43*(F5), (F5W3) M41LLH507XX43*(F5)	630V \pm 10V

4-2-3 CENTER RASTER

Adjust SW401 so that the back raster comes to the center when you apply each basic mode.

4-2-4 Centering

Centering means to position the center point of the display in the middle of the display area. Horizontal size and position and vertical size and position control the centering of the display.

Adjust the horizontal size and vertical size to their optimal settings: 306 mm (H) x 230 mm (V) .

Adjust the horizontal position and vertical position to \leq 4.0 mm of the center point of the screen.

$$|A-B| \leq 4.0 \text{ mm.} \quad |C-D| \leq 4.0 \text{ mm.}$$

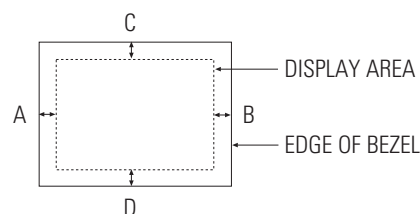

Figure 4-3. Centering

* In Softjig window, "Geometry" has to be selected for GD adjustment.

4-2-4 (a) HORIZONTAL SIZE ADJUSTMENT

CONDITIONS

Scanning frequency: 68 kHz/85 Hz
 Display image: Crosshatch pattern
 Brightness: Maximum
 Contrast: Maximum

Use control bar after selecting "H-SIZE" in left menu to adjust the horizontal size of the display pattern to 306 mm. (Tolerance: \pm 4 mm.)

If "H-SIZE" is not enough to adjust it, select "SIZE B+" by turns.

4 Alignment and Adjustments

4-2-4 (b) VERTICAL SIZE ADJUSTMENT

CONDITIONS

Scanning frequency: 68 kHz/85 Hz
 Display image: Crosshatch pattern
 Brightness: Maximum
 Contrast: Maximum

Use control bar after selecting “**V-SIZE**” in left menu to adjust the vertical size of the display pattern to 230 mm. (Tolerance: ± 4 mm.)

4-2-4 (c) HORIZONTAL POSITION ADJUSTMENT

CONDITIONS

Scanning frequency: 68 kHz/85 Hz
 Display image: Crosshatch pattern

Use control bar after selecting “**H-POSITION**” in left menu to center the horizontal image on the raster.

4-2-4 (d) VERTICAL POSITION ADJUSTMENT

CONDITIONS

Scanning frequency: 68 kHz/85 Hz
 Display image: Crosshatch pattern

Use control bar after selecting “**V-POSITION**” in left menu to center the vertical image on the raster.

4-2-5 Linearity

Linearity affects the symmetry of images as they appear on the screen. Unless each row or column of blocks in a crosshatch pattern is of equal size, or within the tolerances shown in Tables 4-2 and 4-3, an image appears distorted, elongated or squashed.

Table 4-2. Standard Modes Linearity: 640x480/75Hz, 800x600/85Hz and 1024x768/85Hz

	Standard Modes Linearity	
	Each block (10 %)	Difference between adjacent blocks (4 %)
4 : 3	Horizontal: 18.2~20.1 Vertical : 18.2~20.1	Horizontal: Less than 0.77 mm Vertical : Less than 0.77 mm

Table 4-3. Other Modes Linearity: VGA, SVGA, XGA, MAC, etc.

	Supported Timing Mode	
	Each block (14 %)	Difference between adjacent blocks (5 %)
4 : 3	Horizontal: 17.8~20.5 Vertical : 17.8~20.5	Horizontal: Less than 0.96 mm Vertical : Less than 0.96 mm

4-2-5 (a) HORIZONTAL LINEARITY ADJUSTMENT

CONDITIONS

Scanning frequency: 68 kHz/85 Hz
 Display image: Crosshatch pattern
 Brightness: Maximum
 Contrast: Maximum

To adjust the Horizontal Linearity, refer to Tables 4-2 and 4-3 for the tolerance range.

Increase or decrease **H_LIN** to optimize the image.

4-2-5 (b) VERTICAL LINEARITY ADJUSTMENT

CONDITIONS

Scanning frequency: 68 kHz/85 Hz
 Display image: Crosshatch pattern
 Brightness: Maximum
 Contrast: Maximum

To adjust the Vertical Linearity, refer to Tables 4-2 and 4-3 for the tolerance range.

Use control bar after selecting “**V-LINEARITY BAL**” in left menu to optimize the image.

4-2-6 Trapezoid Adjustment

CONDITIONS

Scanning frequency: 68 kHz/85 Hz
 Display image: Crosshatch pattern
 Brightness: Maximum
 Contrast: Maximum

Use control bar after selecting “**TRAPEZOID**” in left menu to make the image area rectangular.

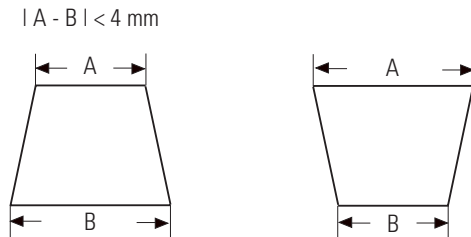

Figure 4-4. Trapezoid

4-2-7 Pinbalance Adjustment

CONDITIONS

Scanning frequency: 68 kHz/85 Hz
 Display image: Crosshatch pattern
 Brightness: Maximum
 Contrast: Maximum

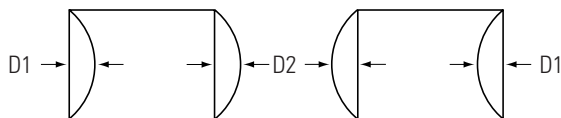

Figure 4-5. Pinbalance

Use control bar after selecting “**PINBALANCE**” in left menu to optimize the image.

4-2-8 Parallelogram Adjustment

CONDITIONS

Scanning Frequency: 68 kHz/85 Hz
 Display image: Crosshatch pattern
 Brightness: Maximum
 Contrast: Maximum

Use control bar after selecting “**PARALLEL**” in left menu to make the image area rectangular.

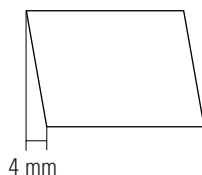

Figure 4-6. Parallelogram

4-2-9 Side Pincushion Adjustment

CONDITIONS

Scanning frequency: 68 kHz/85 Hz
 Display image: Crosshatch pattern

Use control bar after selecting “**PINCUSHION**” in left menu to straighten the sides of the image area.

$|C1|, |C2| \leq 2.0 \text{ mm}, |D1|, |D2| \leq 2.0 \text{ mm}$.

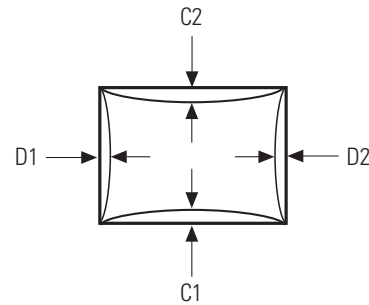

Figure 4-7. Pincushion

4-2-10 Tilt Adjustment

CONDITIONS

Scanning Frequency: 68 kHz/85 Hz
 Display image: Crosshatch pattern
 Brightness: Maximum
 Contrast: Maximum

Use control bar after selecting “**ROTATION**” in left menu to correct the tilt of the display.

4-2-11 Degauss

No adjustments are available for the degaussing circuit. The degaussing circuit can effectively function only once per 30 minutes.

4-2-12 To Delete the User Mode Data

To delete the adjustment data from the user modes, click “@4: USER DELETE” in right ment.

4-2-13 Save the Data

To save the adjustment data for a mode, press “@3: ALL MODE SAVE” in right ment.

4-3 Color Adjustments

CAUTION: Check below condition before color adjustment
 Video signal : Analog 0.7 Vp-p (at 75 Ω)
 Sync : TTL level (H, V separate signal)

* Select "Color" in Softjig menu for color adjustment.

4-3-1 Color Coordinates (Temperature)

Color temperature is a measurement of the radiant energy transmitted by a color. For computer monitors, the color temperature refers to the radiant energy transmitted by white. Color coordinates are the X and Y coordinates on the chromaticity diagram of wavelengths for the visible spectrum.

CONDITIONS

Measurement instrument: Color analyzer
 Scanning frequency: 68 kHz/85 Hz
 Display image: White flat field at center of display area
 Luminance: Maximum

PROCEDURE

Use the directions in sections 4-3-2 through 4-3-3 to adjust the color coordinates for:
 9300K to $x = 0.283 \pm 0.02$, $y = 0.298 \pm 0.02$
 6500K to $x = 0.313 \pm 0.02$, $y = 0.329 \pm 0.02$

4-3-2 Color Adjustments for 9300K

4-3-2 (a) BACK RASTER COLOR ADJUSTMENT

CONDITIONS

Scanning frequency: 68 kHz/85 Hz
 Display image: Back raster pattern
 Brightness: Maximum
 Contrast: Maximum

1. Select "@1: CHANNEL 1" in right menu to control the color for 9300K.
2. Adjust the luminance of the back raster to between 0.5 to 0.7 ft-L using contron bar after selecting "GREEN CUTOFF" in the menu.
3. Use control bar after selecting "BLUE CUTOFF" in left menu to set the "y" coordinate to 0.298 ± 0.02 .
4. Use control bar after selecting "RED CUTOFF" in left menu to 0.283 ± 0.02 .

* If color values would not be matched desirable values, repeat sequence 3 and 4 after readjusting "GREEN CUTOFF" control a little different.

4-3-2 (b) WHITE BALANCE ADJUSTMENT

CONDITIONS

Scanning frequency: 68 kHz/85 Hz
 Display image: White box pattern
 Brightness: 0.06ft-L at Back Raster
 Pattern Display Maximum
 Contrast: Maximum

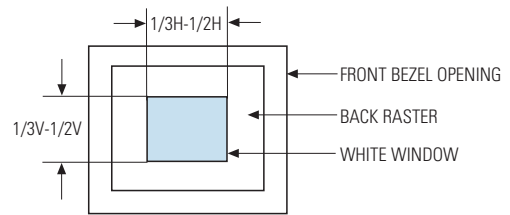

Figure 4-8. White Box Pattern

1. Use control bar after selecting "RED GAIN", "GREEN GAIN" and "BLUE GAIN" to adjust the luminance to 45 ft-L (15") and 46 ft-L (17") with the color coordinates ranged for 9300K to $x = 0.283 \pm 0.02$, $y = 0.298 \pm 0.02$. exception) 17" SDD CRT type-named (* /S-2) : 42ft-L.

4-3-2 (c) ABL ADJUSTMENT

CONDITIONS

Scanning frequency: 68 kHz/85 Hz
 Display image: Full white pattern
 Brightness: Maximum
 Contrast: Maximum

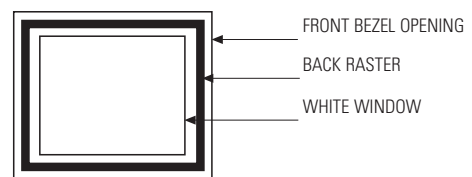

Figure 4-9. Full White Pattern

1. Check the ABL. If it is not within the specifications, use the ABL controls to adjust it. (36 ± 1 ft-L)
2. Select "@4: COLOR SAVE" to save the data.
3. Select "@6: ALL COLOR SAVE" to save the CH2.

4-3-2 (d) WHITE BALANCE ADJUSTMENT VERIFICATION

CONDITIONS

Scanning frequency:	68 kHz/85 Hz
Display image:	Back raster pattern Full White Pattern
X-Y Coordinates:	$x = 0.283 \pm 0.02$, $y = 0.298 \pm 0.02$
ABL Luminance	Refer to 4-3-2(c)
Brightness:	Maximum
Contrast:	5 ft-L, 24 ft-L

1. Check whether the color coordinates of the back raster satisfy the above spec.
If they do not, return to 4-3-2 (a) and readjust all settings.
2. Display a full white pattern.
3. Select "Geometry" in softjig menu.
4. Select "@7: 5-ft " in right menu.
5. Check whether the white coordinates of the video meet the above coordinates spec.
6. Select "@8: 24-ft " in right menu.
7. Check whether the white coordinates of the video satisfies the above spec.

If they do not, return to 4-3-2 (a) and readjust all settings.

Select "Color" and click "@2: CHANNEL 2" for color adjustment for 6500K
Repeat the sequence of 9300K adjustment.
The luminance values the same as 9300K, but the color coordinated of back raster and white box are : $x = 0.313 \pm 0.02$ $y = 0.329 \pm 0.02$

4-3-3 Luminance Uniformity Check

Luminance is considered uniform only if the ratio of lowest to highest brightness areas on the screen is not less than 7.5:10.

CONDITIONS

Scanning frequency:	68 kHz/85 Hz (1024 x 768)
Display image:	White flat field
Brightness:	Cut off point at 24 ft-L
Contrast:	Maximum

PROCEDURE

Measure luminance at nine points on the display screen (see figure below).

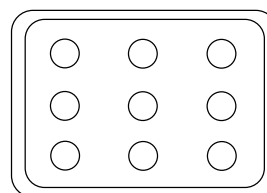

Figure 4-10. Luminance Uniformity Check Locations

4-3-4 Focus Adjustment

CONDITIONS

Scanning frequency:	68 kHz/85 Hz (1024 x 768)
Display image:	"H" character pattern
Brightness:	Cut off point
Contrast:	Maximum

PROCEDURE

1. Adjust the Focus VR on the FBT to display the sharpest image possible.
2. Use Locktite to seal the Focus VR in position.

4-3-5 Color Purity Adjustment

Color purity is the absence of undesired color. Conspicuous mislending (unexpected color in a uniform field) within the display area shall not be visible at a distance of 50 cm from the CRT surface.

CONDITIONS

Orientation:	Monitor facing east
Scanning frequency:	68 kHz/85 Hz
Display image:	White flat field
Luminance:	Cut off point at the center of the display area

Note: Color purity adjustments should only be attempted by qualified personnel.

PROCEDURE

For trained and experienced service technicians only.

Use the following procedure to correct minor color purity problems:

1. Make sure the display is not affected by external magnetic fields.
2. Very carefully break the glue seal between the 2-pole purity convergence magnets (PCM), the band and the spacer (see Figures 4-12).
3. Make sure the spacing between the PCM assembly and the CRT stem is $29 \text{ mm} \pm 1 \text{ mm}$.
4. Display a green pattern over the entire display area.
5. Adjust the purity magnet rings on the PCM assembly to display a pure green pattern. (Optimum setting: $x = 0.295 \pm 0.015$, $y = 0.594 \pm 0.015$)
6. Repeat steps 4 and 5 using a red pattern and then again, using a blue pattern.

Table 4-4. Color Purity Tolerances

Red:	$x = 0.640 \pm 0.015$	$y = 0.323 \pm 0.015$
Green:	$x = 0.295 \pm 0.015$	$y = 0.594 \pm 0.015$
Blue:	$x = 0.142 \pm 0.015$	$y = 0.066 \pm 0.015$

(For 9300K color adjustment: $x = 0.283 \pm 0.02$, $y = 0.298 \pm 0.02$)

7. When you have the PCMs properly adjusted, carefully glue them together to prevent their movement during shipping.

5 Troubleshooting

5-1 Parts Level Troubleshooting

- Notes:**
- If a picture does not appear, fully rotate the brightness and contrast controls clockwise and reinspect.
 - Check the following circuits.
 - No raster appears: Power circuit, Horizontal output circuit.
 - High voltage develops but no raster appears: Video output circuits.
 - High voltage does not develop: Horizontal output circuits.

5-1-1 No Power Supply

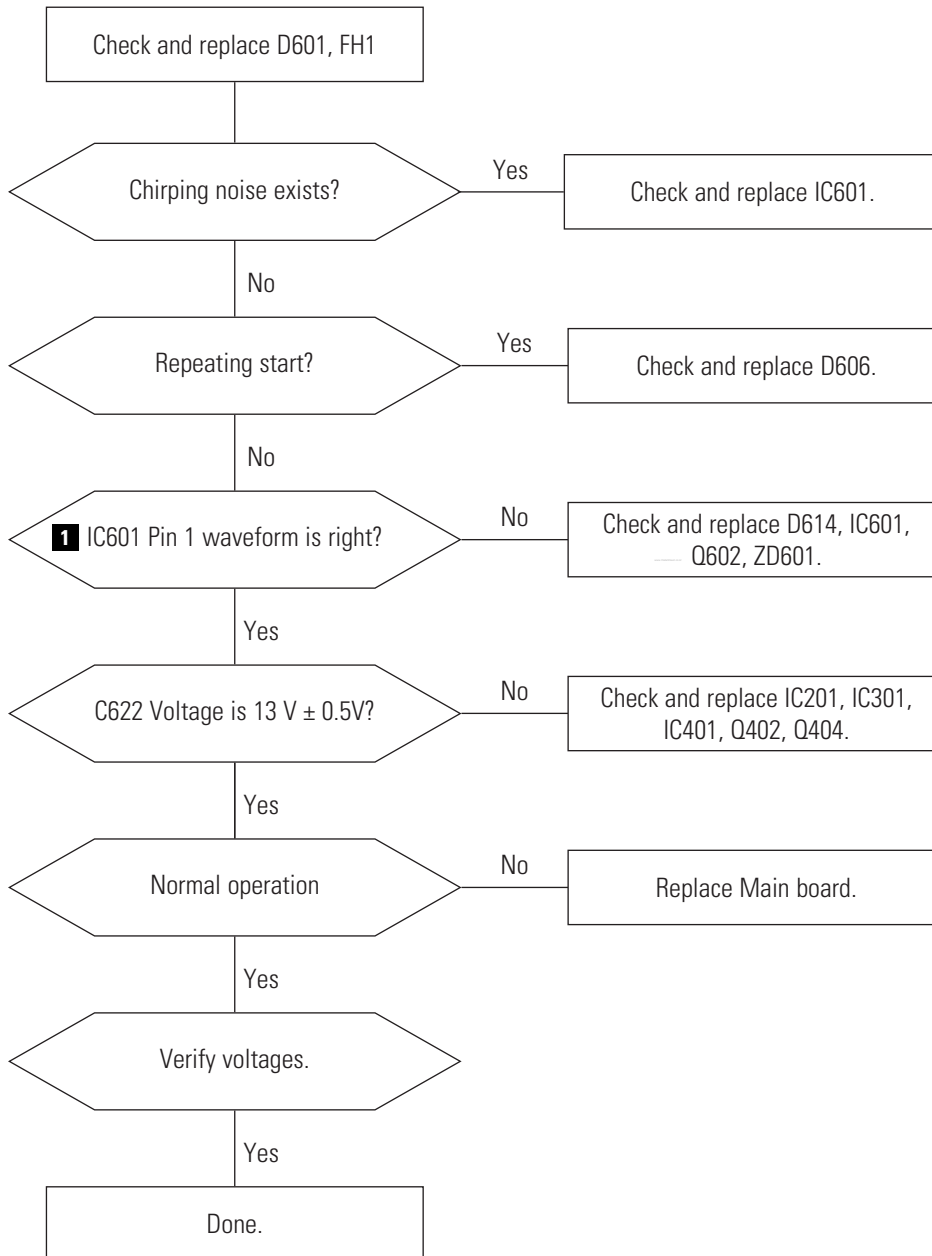

WAVEFORMS

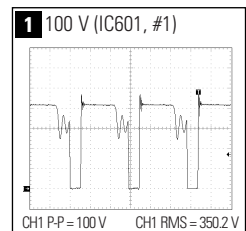

5-1-2 DPMS Failure

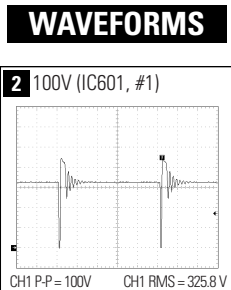
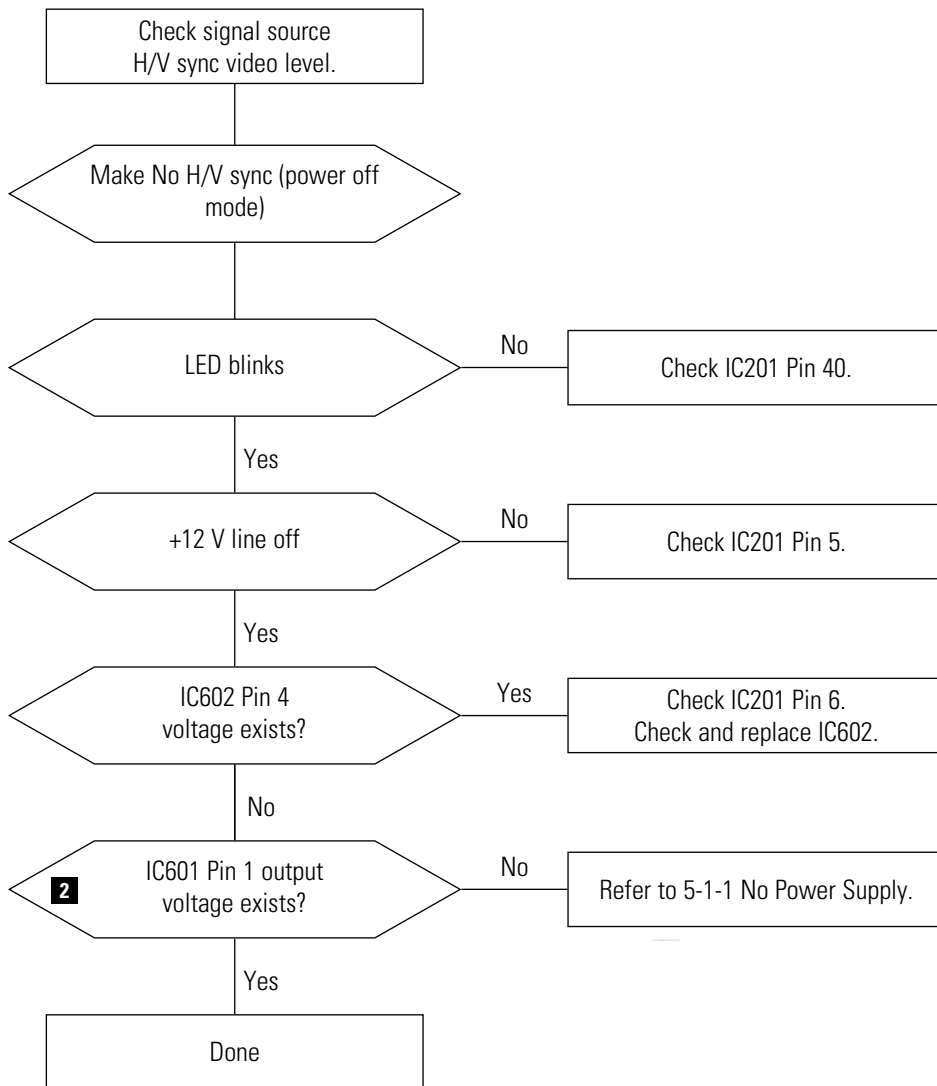

5-1-3 H_Deflection Failure

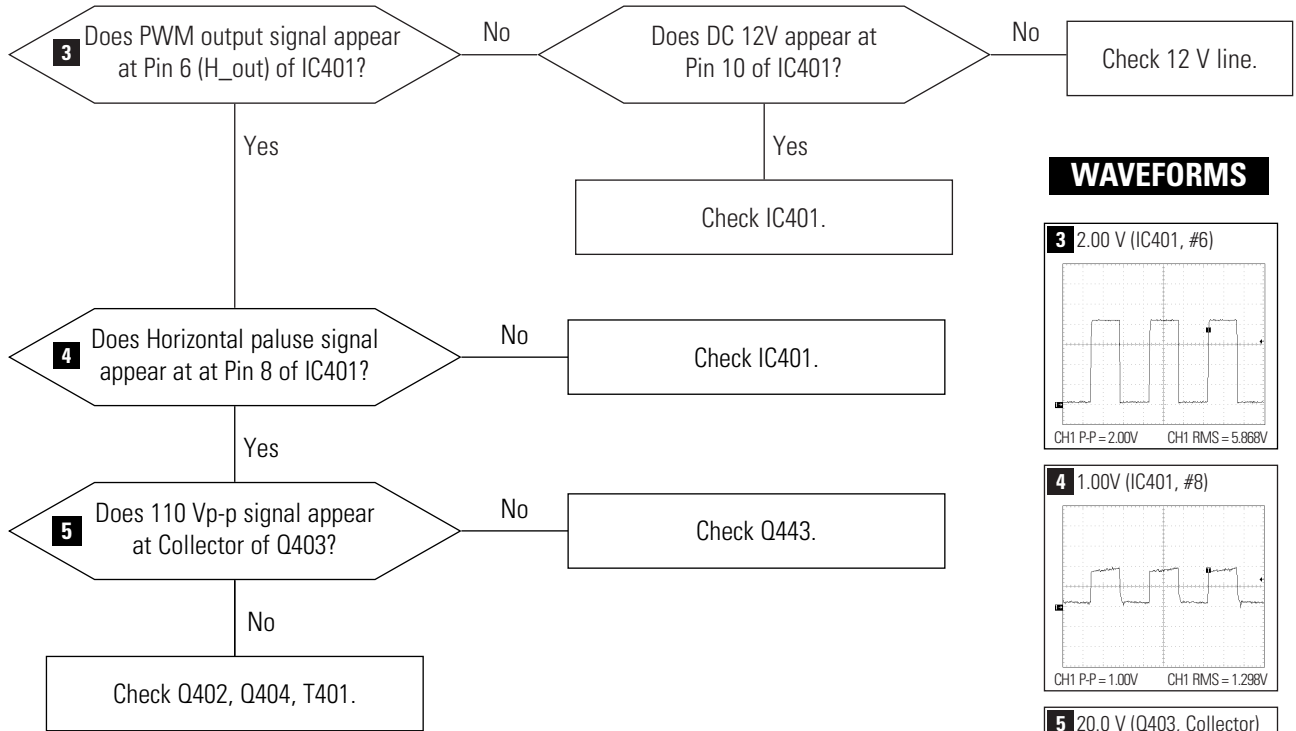

WAVEFORMS

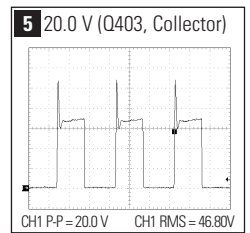
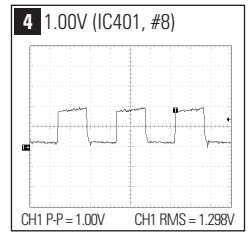
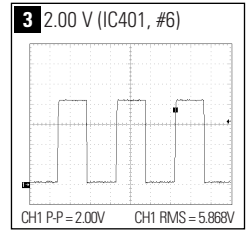

7-1-4 S Correction Failure

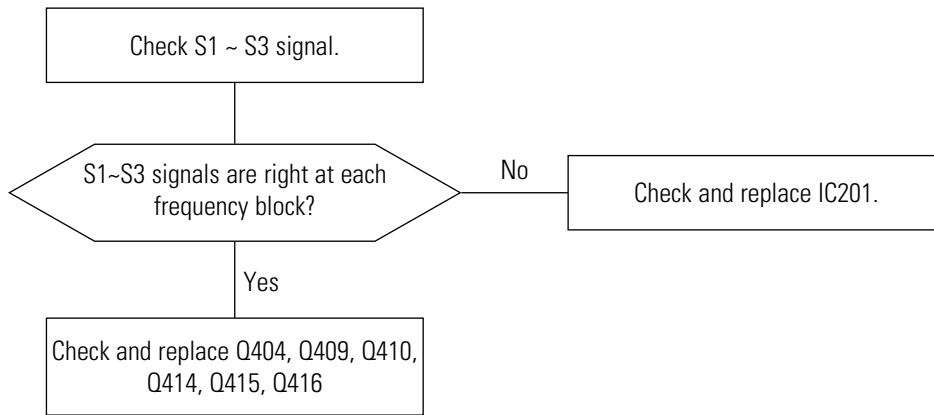

5-1-5 H_Lin. Failure

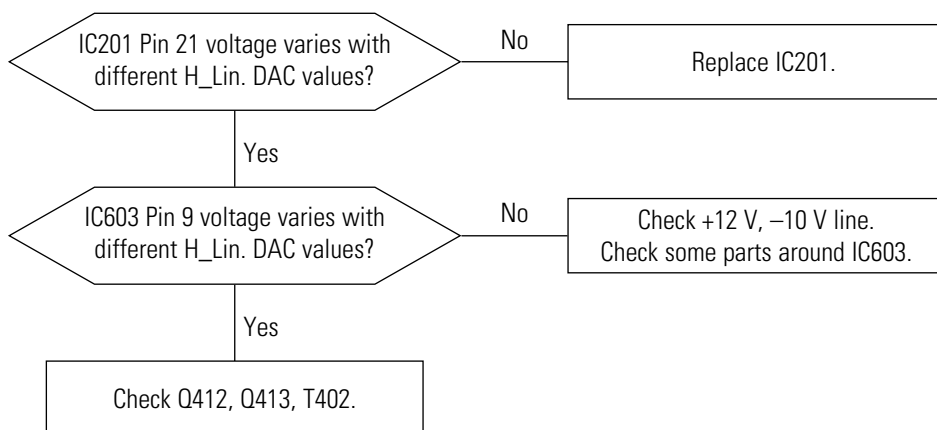

5-1-6 Invariable H_Size

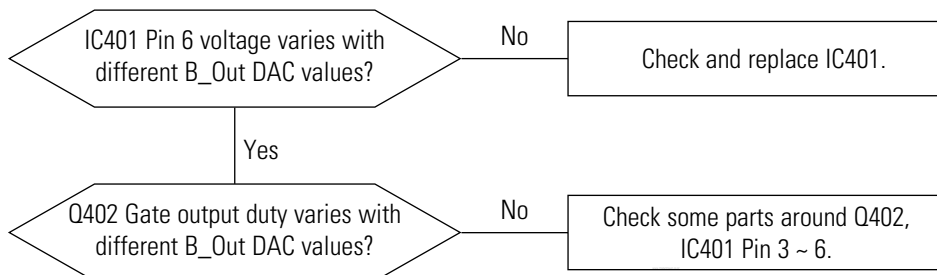

5-1-7 Abnormal H_Size

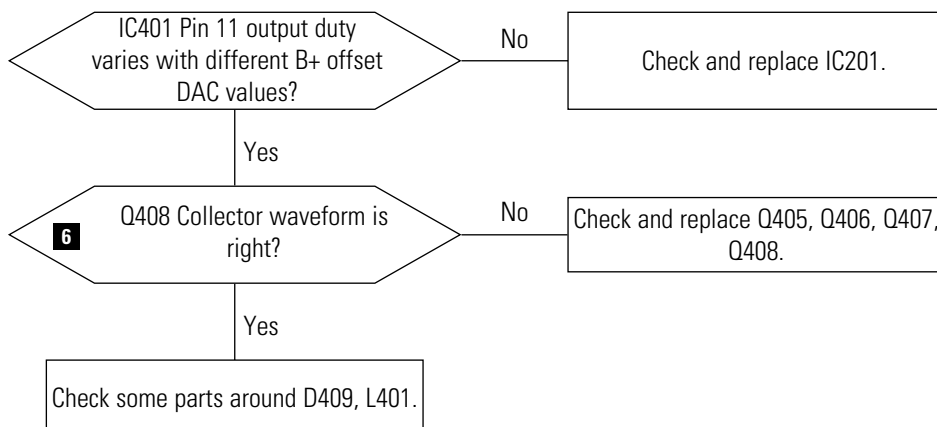

WAVEFORMS

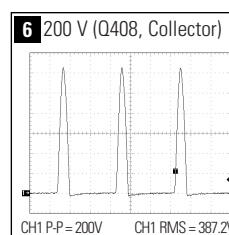

5-1-8 Side Pin or Trap Failure

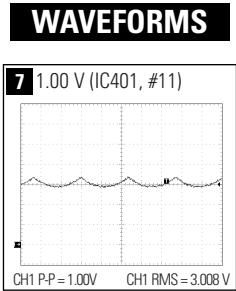
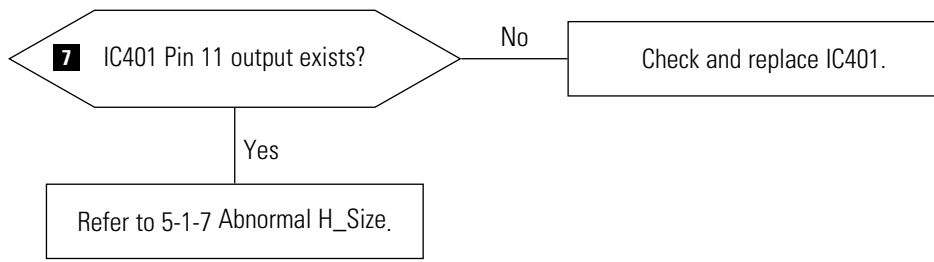

5-1-9 Para. or Pin Balance Failure

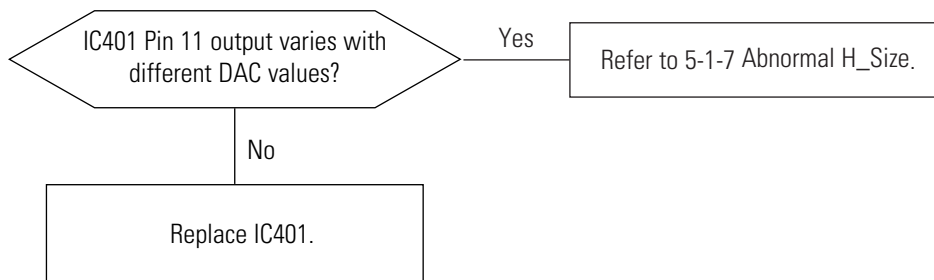

5-1-10 Tilt Failure

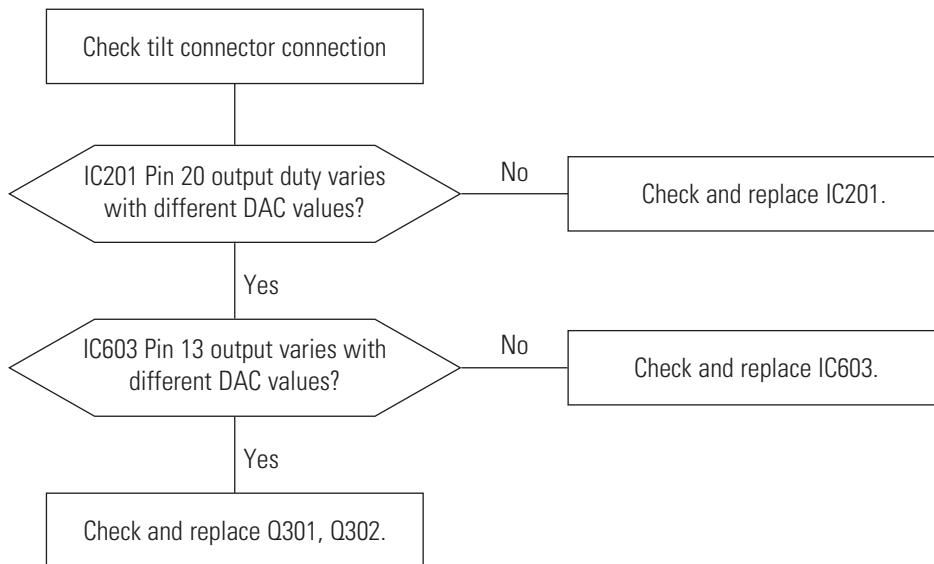

5-1-11 V Deflection Failure

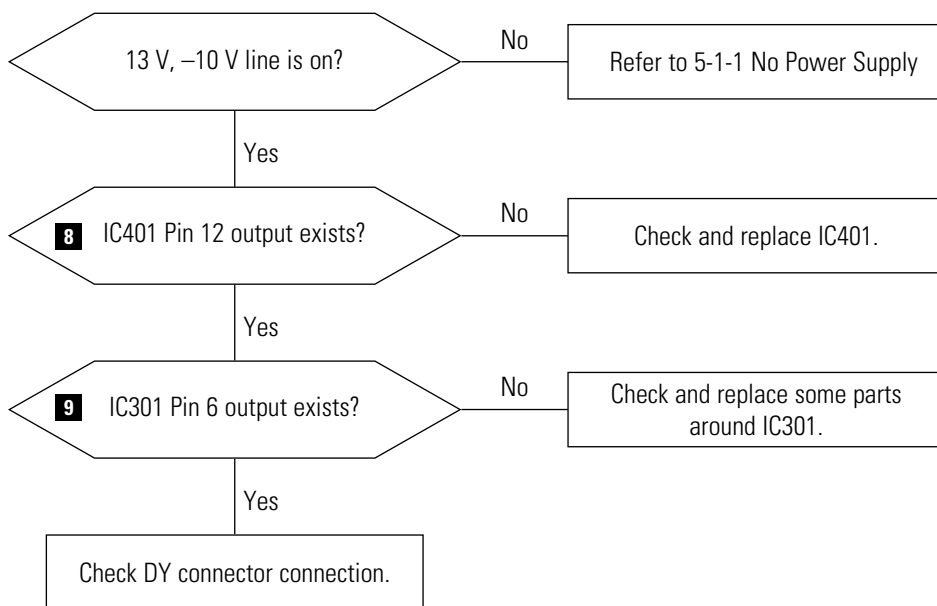

WAVEFORMS

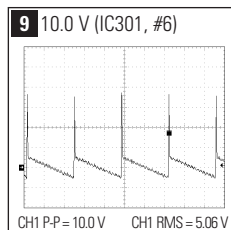
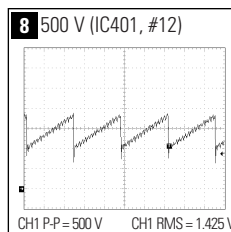

5-1-12 V Size or Pos. Variation Failure

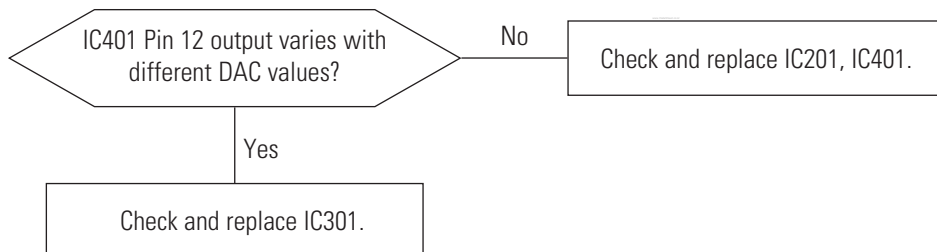

5-1-13 High Voltage Failure

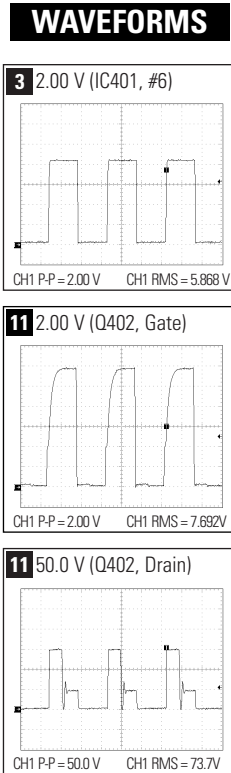
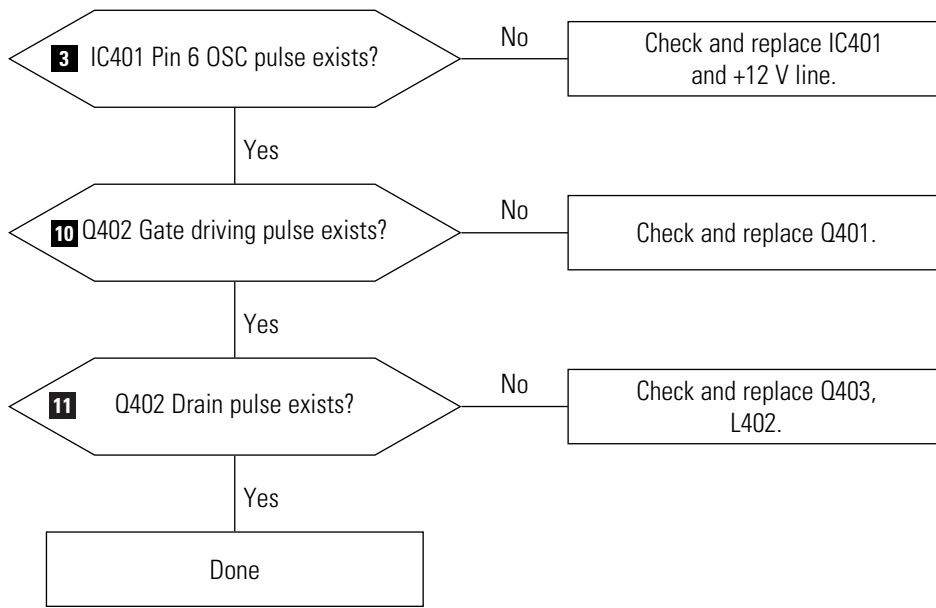

5-1-14 ABL Failure

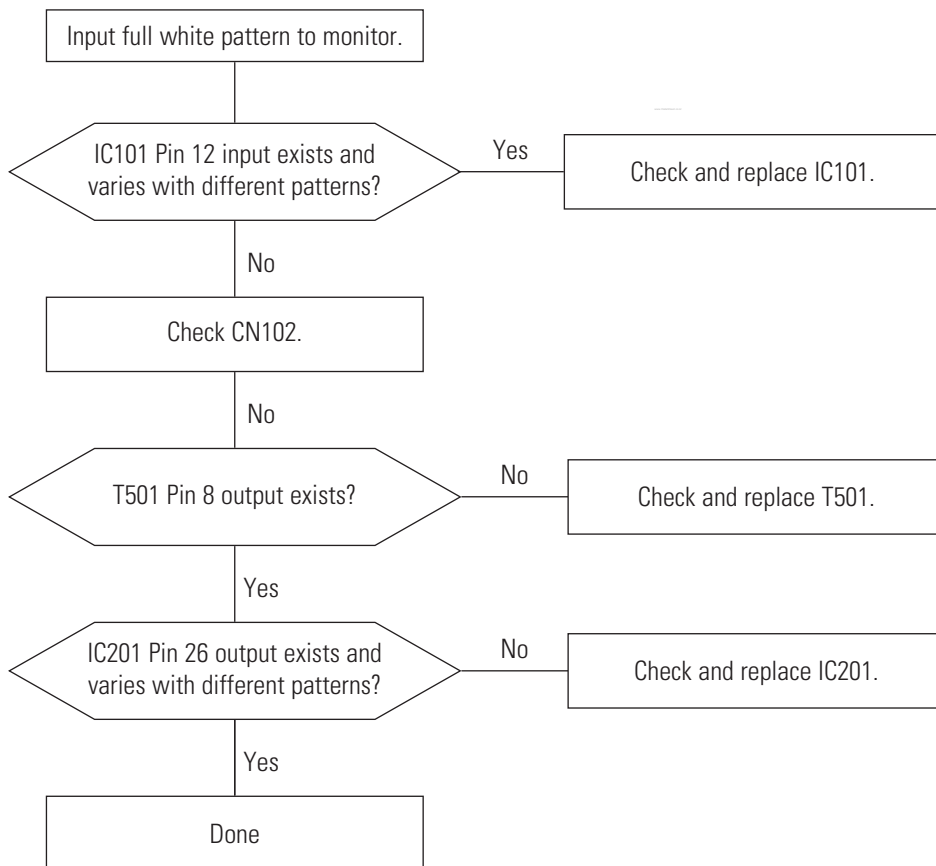

5-1-15 Dynamic Focus Failure

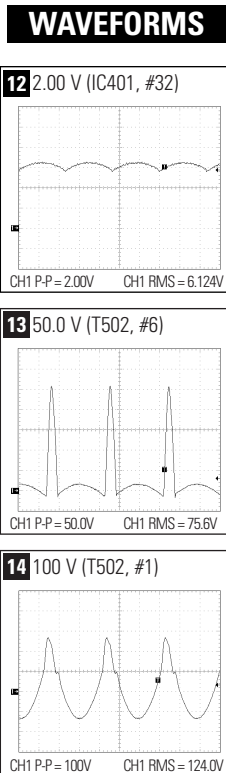
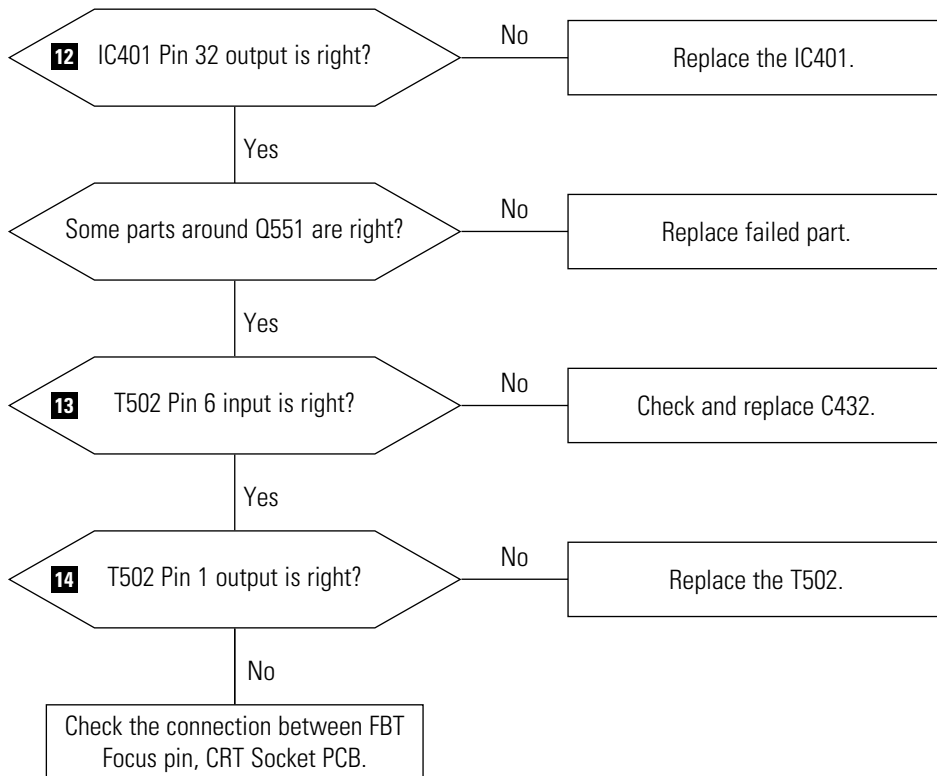

5-1-16 No Video

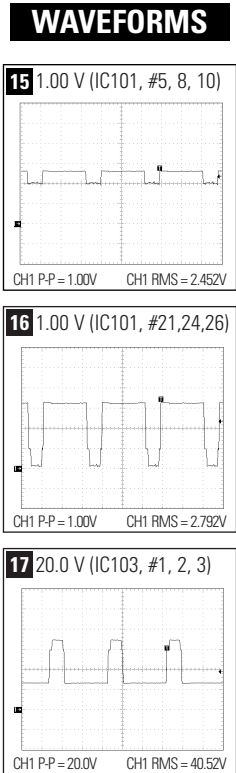
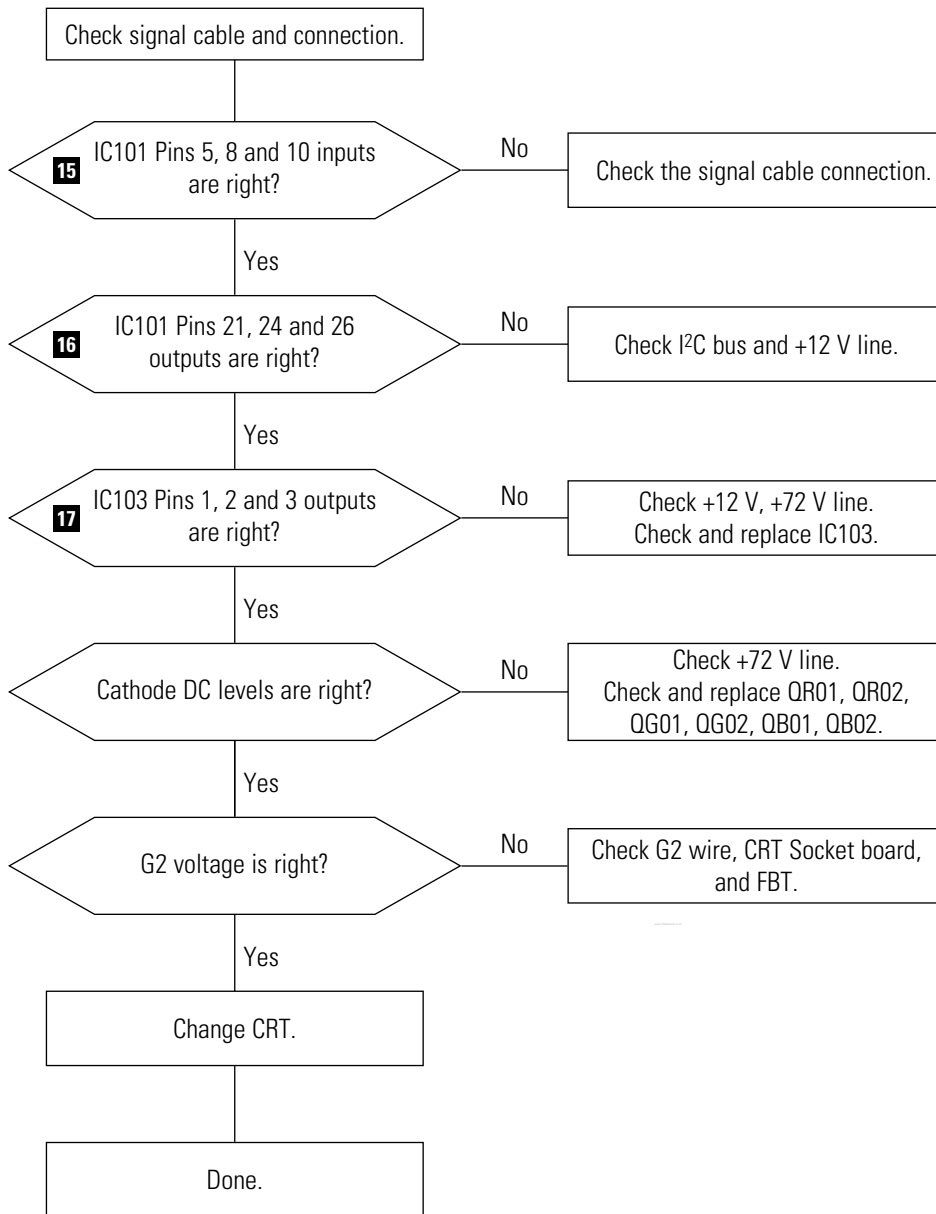

5-1-17 Micom Failure

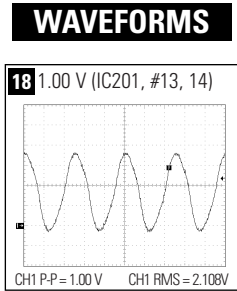
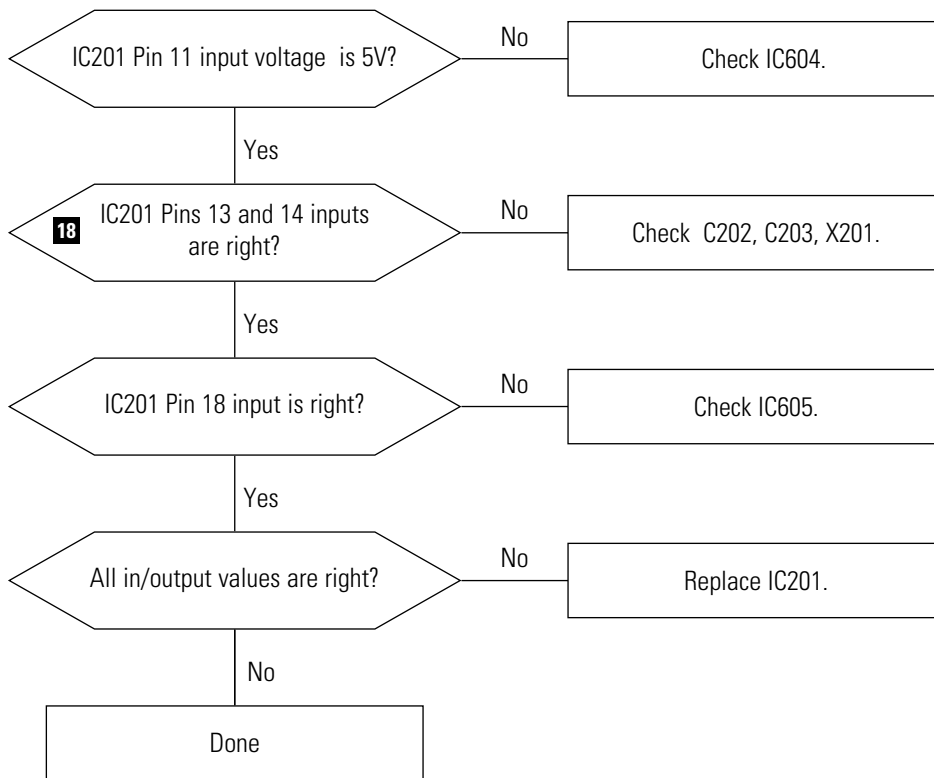

5-1-18 OSD Failure

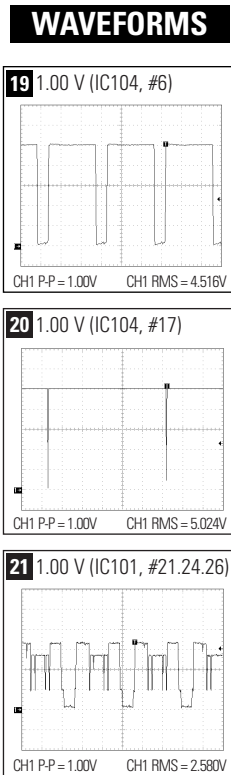
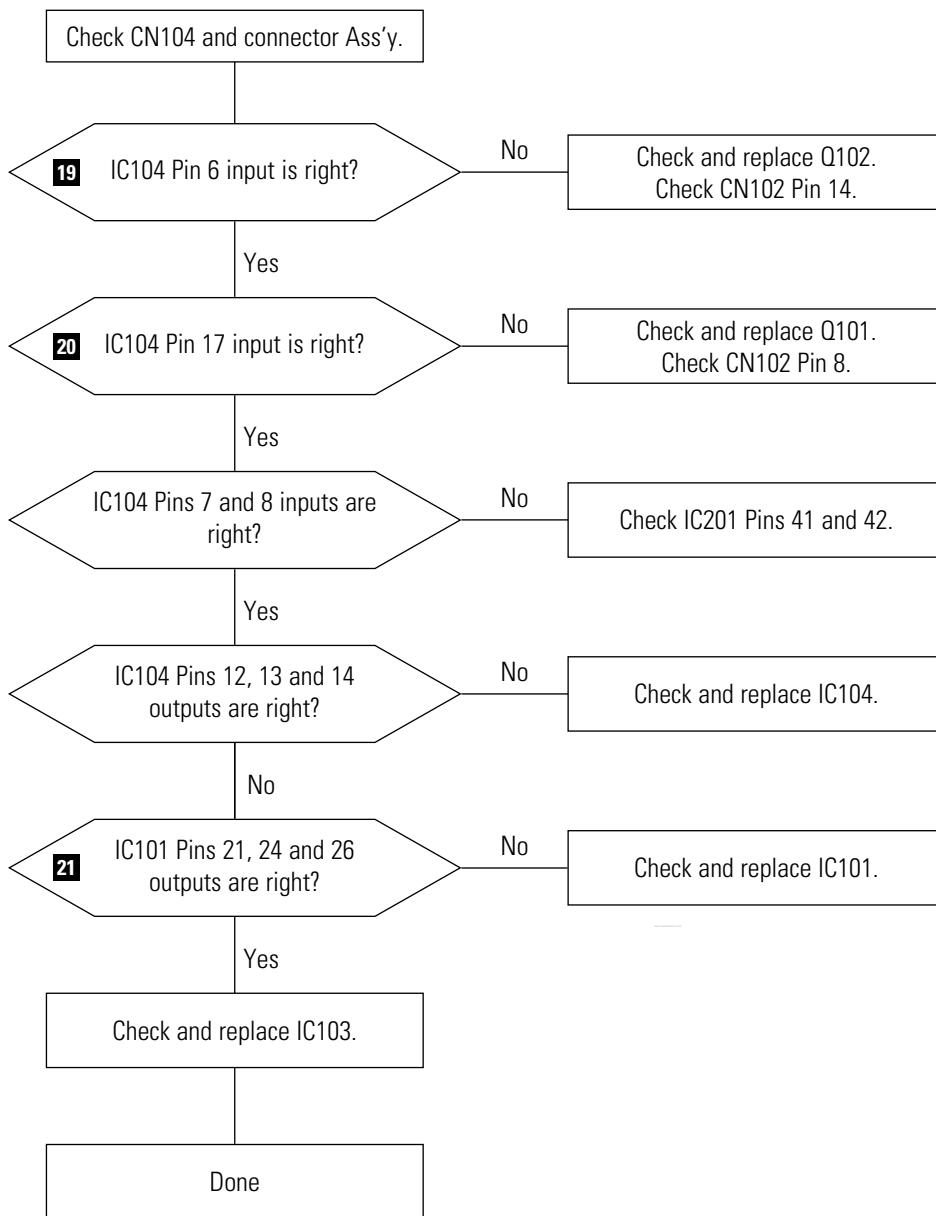

5-1-19 User Control Failure

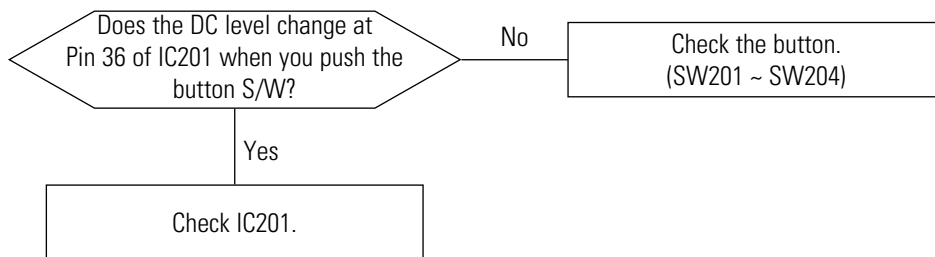

5-1-20 Degaussing Failure

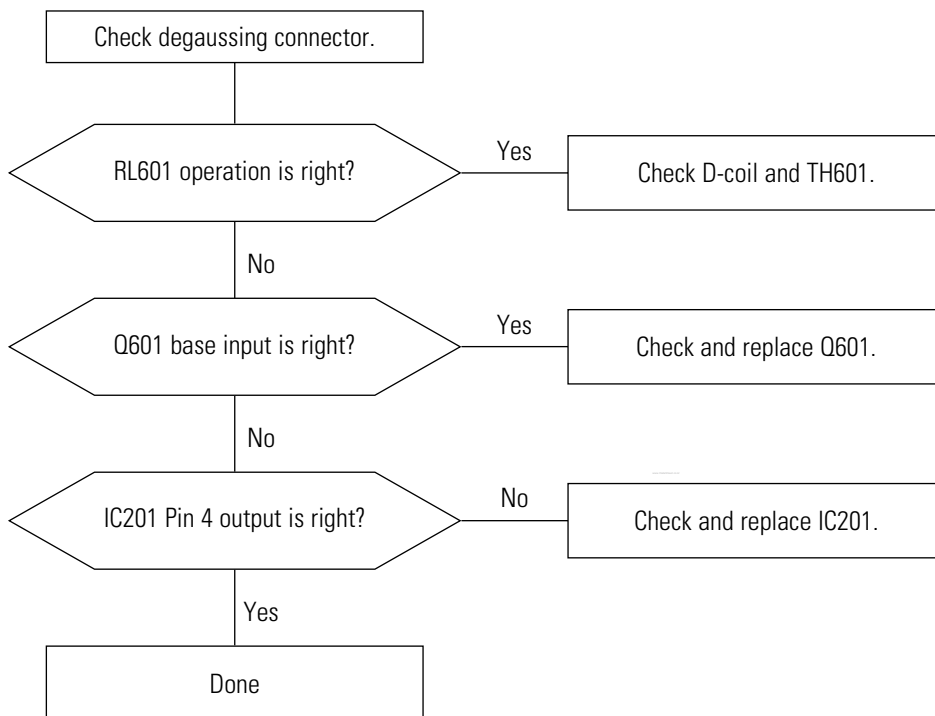

5-2 General Troubleshooting

5-2-1 No Picture

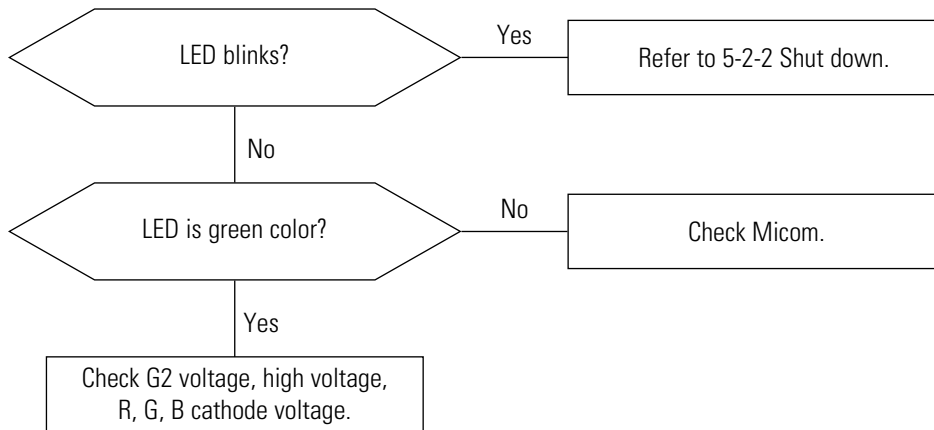

5-2-2 Shut Down

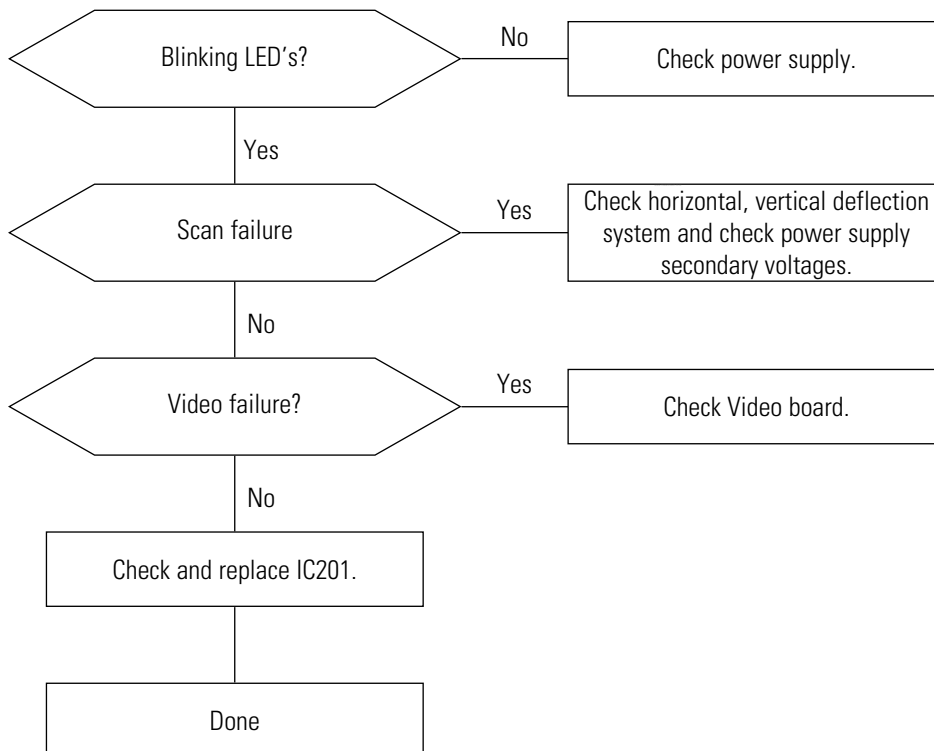

5-2-3 Missing Color

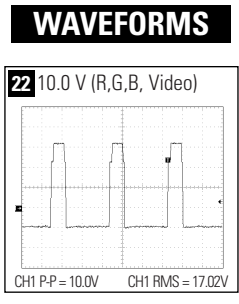
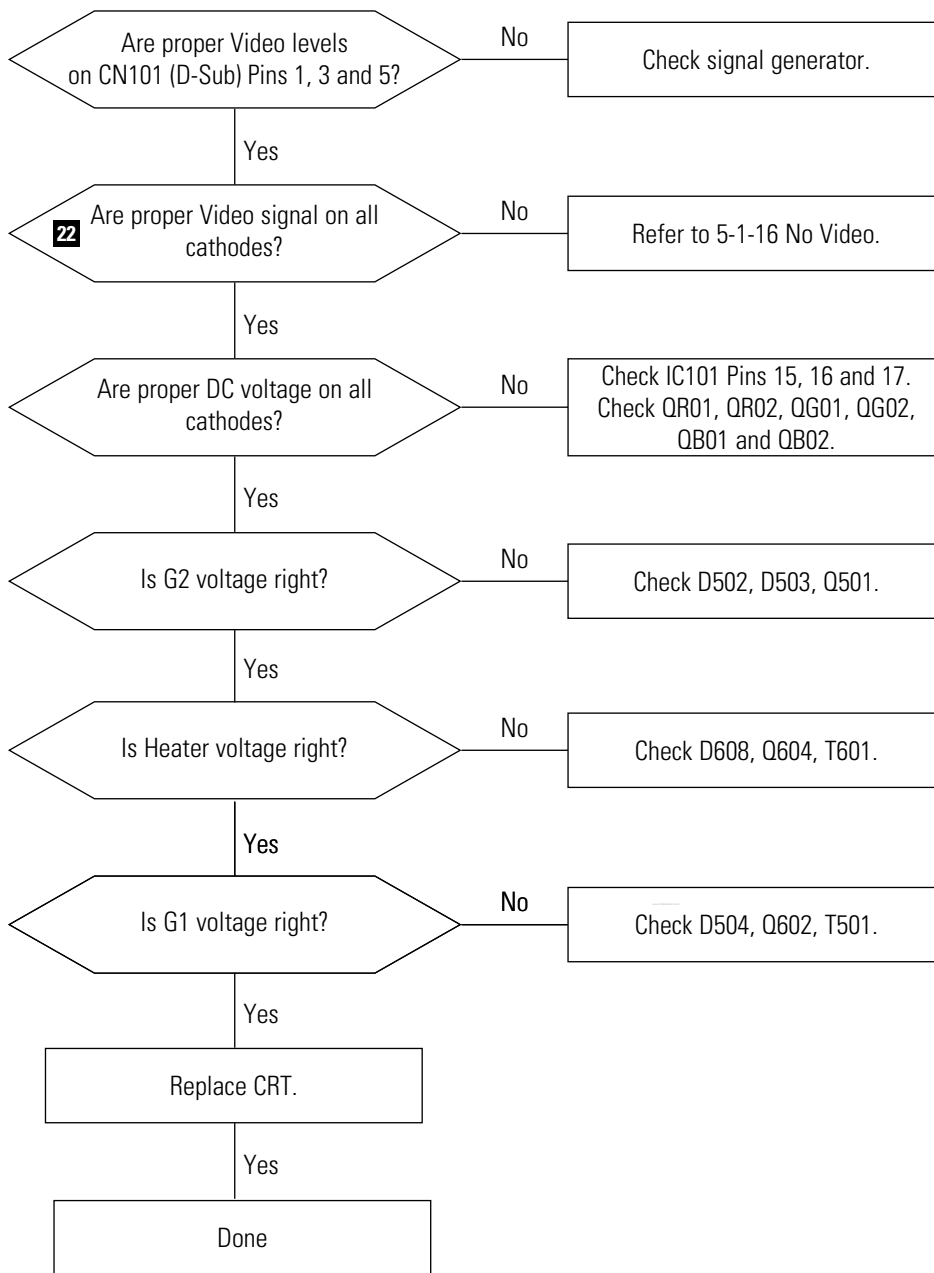

5-2-4 Visible Retrace

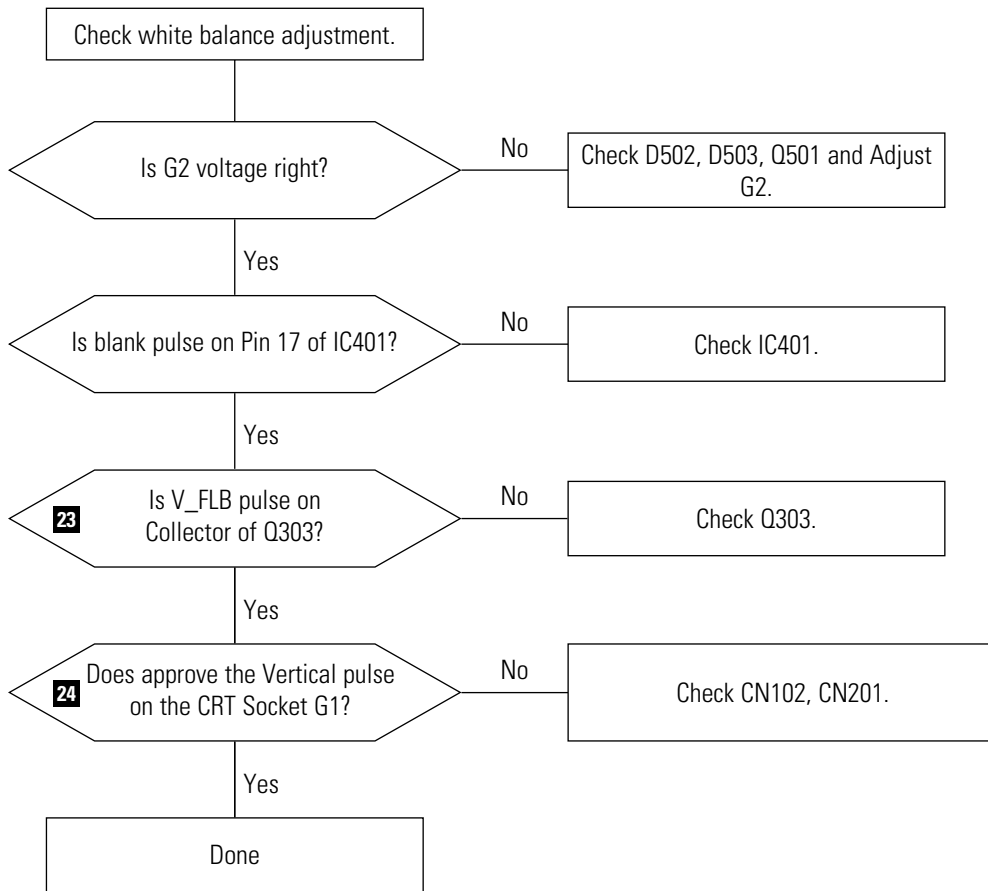

WAVEFORMS

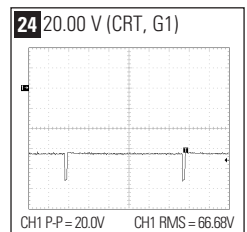
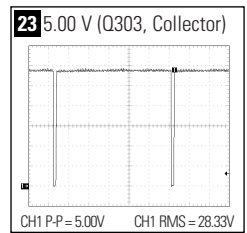

5-2-5 Unsynchronized Image

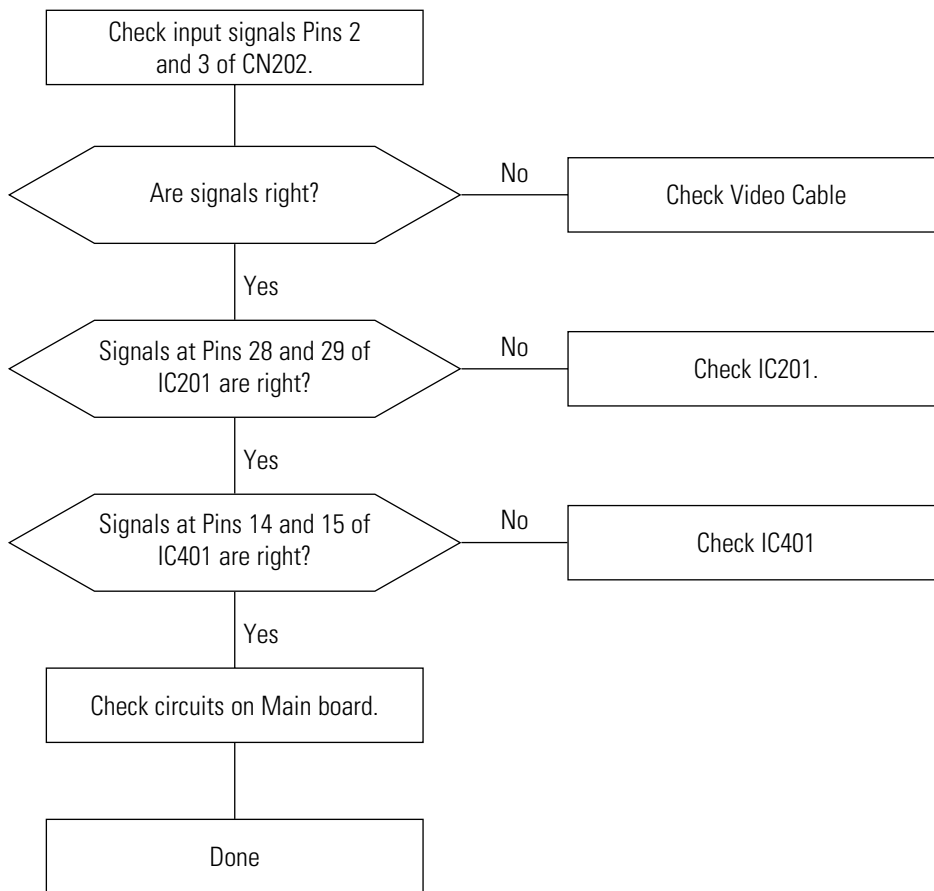

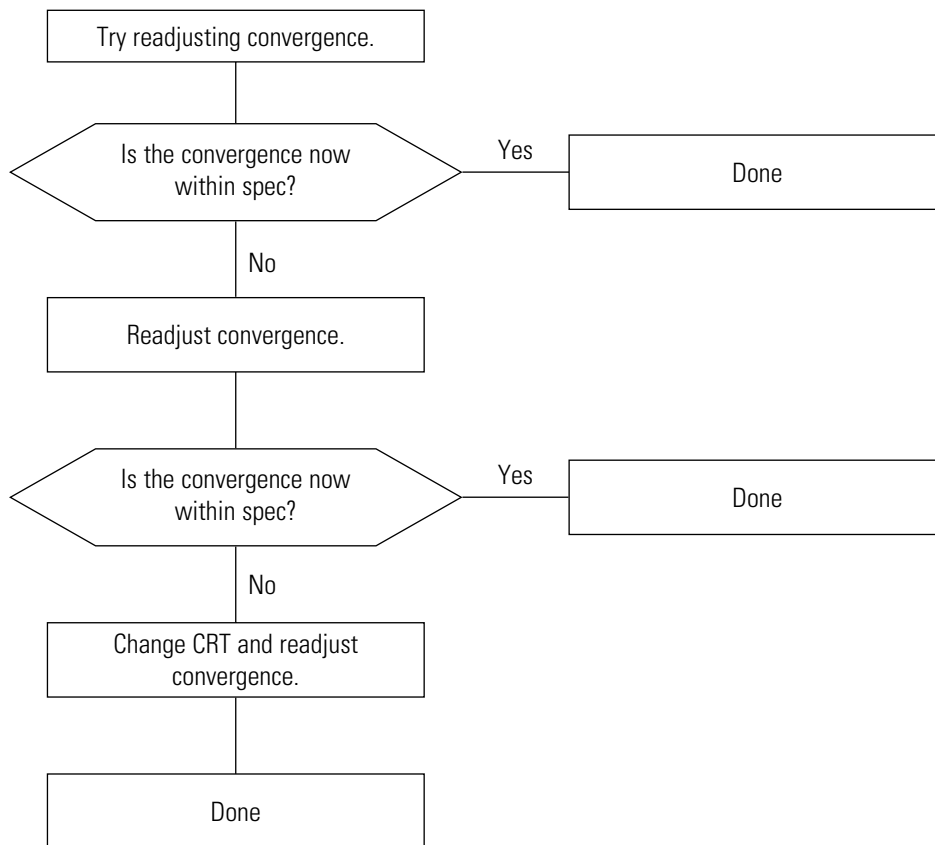
5-2-6 Misconvergence

5-2-7 Poor Focus

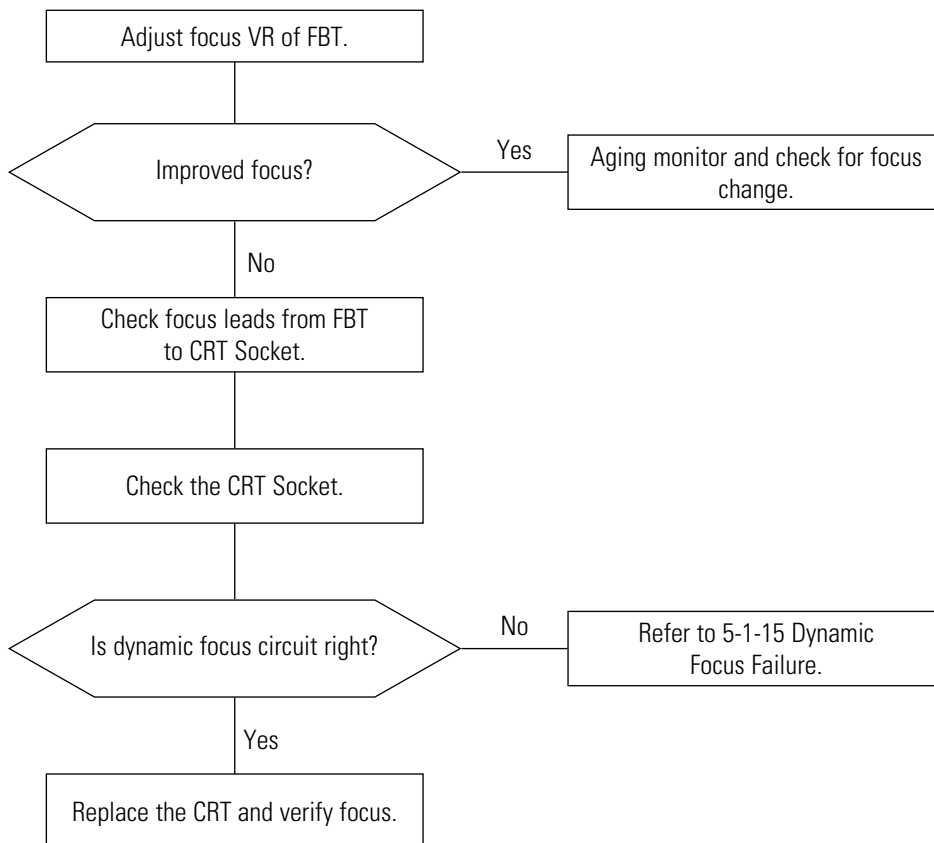

5-2-8 Purity Failure

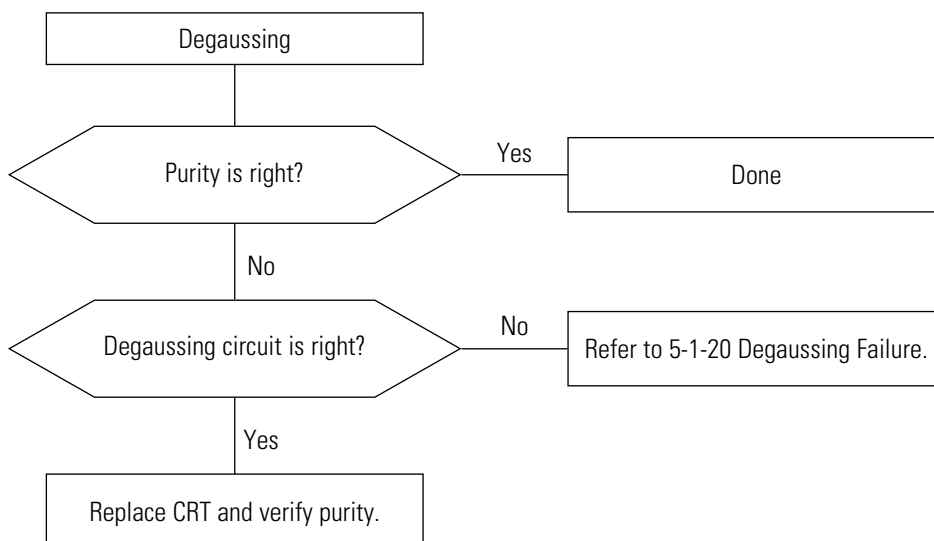

6 Exploded View and Parts List

6-1 Front Cover & CRT Ass'y

NO	DESCRIPTION	CODE-NO	SPECIFICATION	Q'TY	REMARK
1	UNIT/COVER-FRONT	BH75-00143A	TP17LT	1 EA	
2	SCREW-CRT/TAP TITE	6006-001010	WPP,BH,+,05,L25	4 EA	
3	UNIT/SHIELD-VIDEO	BH75-00033A	DP17L*	1 EA	
4	SHIELD/VIDEO-CAP	BH75-00047A	DP17L*	1 EA	
5	SCREW	6008-000010	BH M3XL10	2 EA	
6	VIDEO-PCB		TP17LT	1 EA	
7	D-COIL ASS'Y		TP17LT	1 EA	

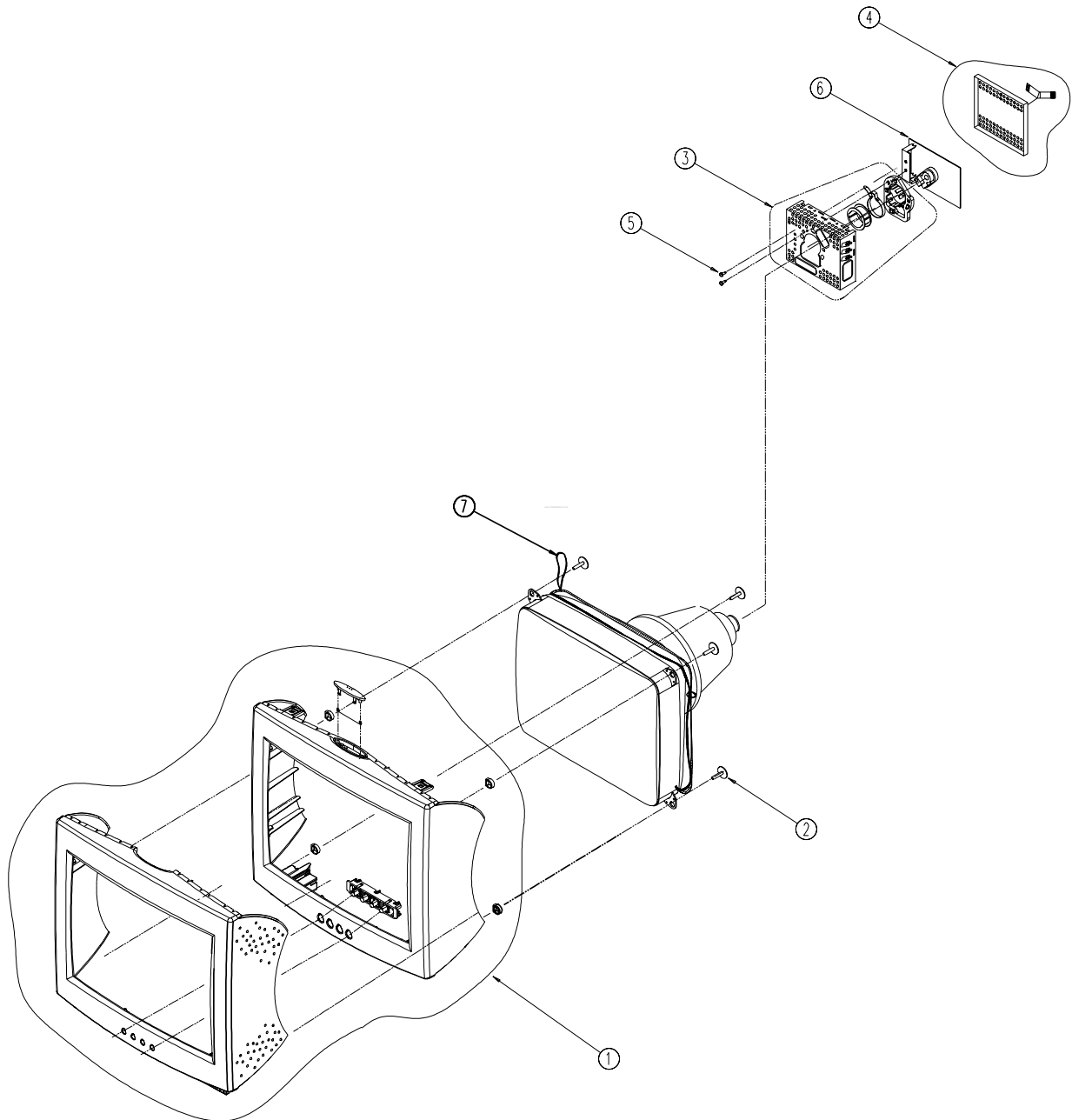

6-2 Chassis & Stand Ass'y

NO	DESCRIPTION	CODE-NO	SPECIFICATION	Q'TY	REMARK
1	UNIT/SHIELD-BOTTOM	BH75-00145A	TP17LT	1 EA	
2	COVER-SIGNAL	BH72-00126A	ABS HB TP02	1 EA	
3	COVER-PCB	BH72-00132A	PVC V0 T1.0 BLACK	1 EA	
4	SCREW	6006-000010	BH M3XL10	5 EA	
5	MAIN-PCB		TP17LT	1 EA	
6	SCREW	6003-001136	BH M4XL8	1 EA	
7	SHEET-LMF	BH72-00078A	AL+PC T0.5	1 EA	
8	SCREW	6003-000010	BH M3XL10	2 EA	

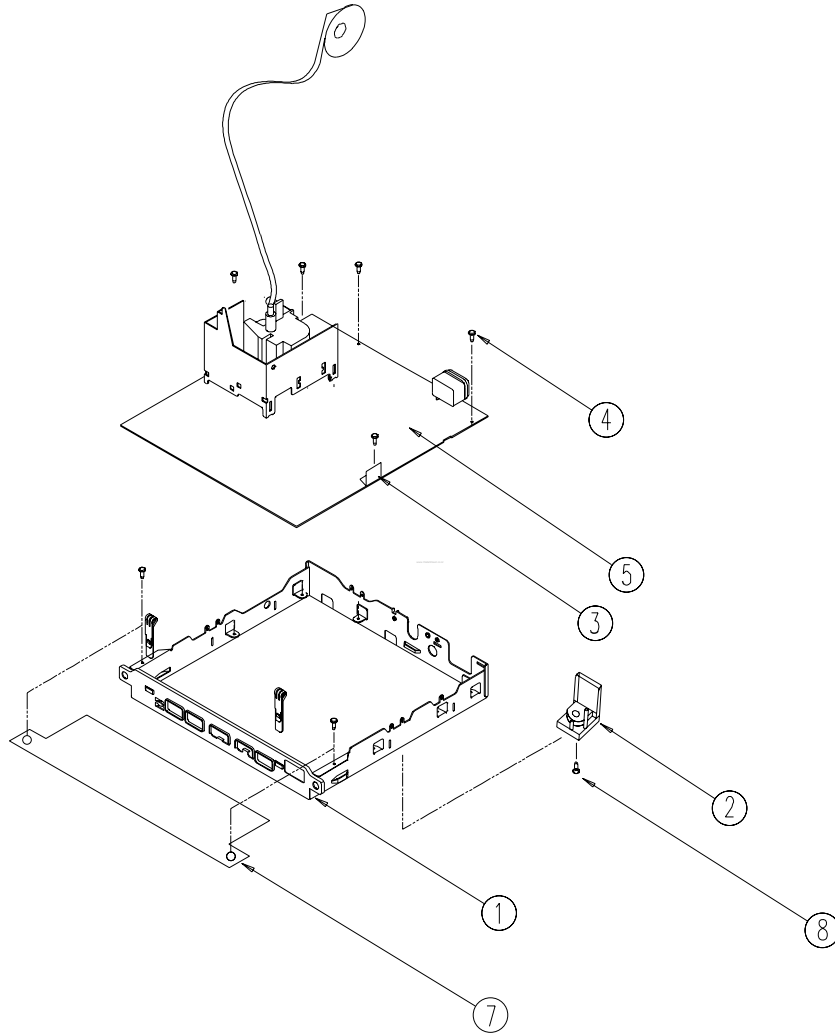

6-3 Rear Cover Ass'y

NO	DESCRIPTION	CODE-NO	SPECIFICATION	Q'TY	REMARK
1	UNIT/SHIELD-COVER	BH75-00145A	TP17LT	1 EA	
2	UNIT/COVER-REAR	BH75-00144A	TP17LT	1 EA	
3	SCREW	6003-00009	BH M4XL16	2 EA	
4	SCREW	6003-00010	BH M3XL10	1 EA	
5	SCREW	6003-00012	BH M4XL12	4 EA	
6	LABEL RATING			1 EA	

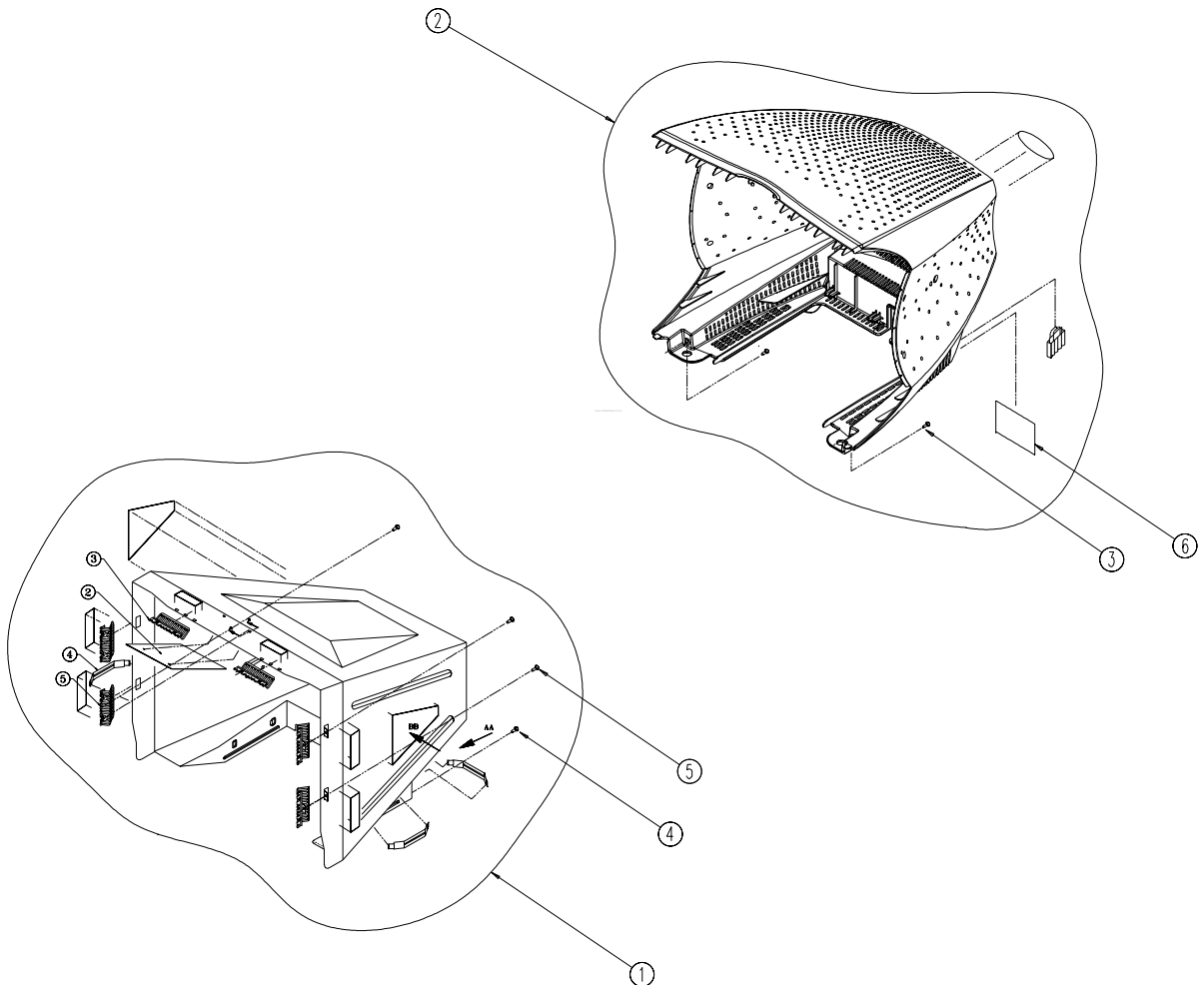

Memo

7 Electrical Parts List

7-1 Main PCB Parts

Loc. No.	Code No.	Description	Specification	Remarks
BD301	3301-000011	CORE-FERRITEBEAD	AA,3.5x1.0x5.7mm,1500	
BD401	3301-000011	CORE-FERRITEBEAD	AA,3.5x1.0x5.7mm,1500	
BD402	3301-000011	CORE-FERRITEBEAD	AA,3.5x1.0x5.7mm,1500	
BD601	3301-000011	CORE-FERRITEBEAD	AA,3.5x1.0x5.7mm,1500	
BD602	3301-000011	CORE-FERRITEBEAD	AA,3.5x1.0x5.7mm,1500	
BD603	3301-000011	CORE-FERRITEBEAD	AA,3.5x1.0x5.7mm,1500	
C201	2401-000025	C-AL	100uF,20%,16V,GP,TP,6.3x11,5	
C202	2201-000389	C-CERAMIC,DISC	0.022nF,5%,50V,NP0,TP,5x3	
C203	2201-000389	C-CERAMIC,DISC	0.022nF,5%,50V,NP0,TP,5x3	
C204	2401-002075	C-AL	4.7uF,20%,50V,GP,TP,5x11,5	
C205	2401-000603	C-AL	1uF,20%,50V,GP,TP,5x11,5	
C206	2401-000050	C-AL	10uF,20%,16V,GP,TP,5x11,2,5	
C207	2401-002075	C-AL	4.7uF,20%,50V,GP,TP,5x11,5	
C209	2401-002075	C-AL	4.7uF,20%,50V,GP,TP,5x11,5	
C210	2401-002075	C-AL	4.7uF,20%,50V,GP,TP,5x11,5	
C211	2201-000146	C-CERAMIC,DISC	0.1nF,5%,50V,SL,TP,5x3.5	
C212	2201-000017	C-CERAMIC,DISC	1nF,10%,50V,Y5P,TP,5x3.5	
C213	2401-000029	C-AL	10uF,20%,100V,GP,TP,6.3x11,5	
C214	2401-000025	C-AL	100uF,20%,16V,GP,TP,6.3x11,5	
C215	2201-000146	C-CERAMIC,DISC	0.1nF,5%,50V,SL,TP,5x3.5	
C216	2401-000603	C-AL	1uF,20%,50V,GP,TP,5x11,5	
C217	2202-002009	C-CERAMIC,MLC-AXIAL	100nF,+80-20%,50V,Y5	
C220	2401-000025	C-AL	100uF,20%,16V,GP,TP,6.3x11,5	
C301	2301-000010	C-FILM,PEF	100nF,5%,100V,TP,11.5x12.5mm	
C302	2305-001041	C-FILM,MPEF	220nF,5%,63V,TP,7.5x4.5x13.5	
C305	2401-000037	C-AL	470uF,20%,16V,GP,TP,8x11.5,5	
C306	2401-000856	C-AL	220uF,20%,35V,WT,TP,10x20,5	
C307	2305-000237	C-FILM,MPEF	1uF,5%,63V,TP,7.5x15.5mm,5mm	
C308	2301-000013	C-FILM,PEF	4.7nF,5%,100V,TP,10.5x12.5x6	
C309	2202-002008	C-CERAMIC,MLC-AXIAL	10nF,+80-20%,50V,Y5V	
C311	2301-001027	C-FILM,PEF	15nF,10%,250V,TP,9.5x12x4.5,5	
C312	2401-001016	C-AL	3.3UF,20%,50V,BP,TP,5X11,5	
C401	2301-000312	C-FILM,PEF	8.2nF,5%,100V,TP,6x12.5mm,5mm	
C402	2201-000119	C-CERAMIC,DISC	100nF,+80-20%,50V,Y5V,TP	
C403	2301-000148	C-FILM,PEF	10nF,5%,100V,TP,7x3.2x7mm,5mm	
C404	2301-000148	C-FILM,PEF	10nF,5%,100V,TP,7x3.2x7mm,5mm	
C405	2201-000823	C-CERAMIC,DISC	0.27nF,5%,50V,SL,TP,8x3.5	
C406	2301-000519	C-FILM,PEF	3.3nF,5%,100V,TP,5.8x3x12.5,5	
C407	2401-000540	C-AL	150uF,20%,63V,LZ,TP,10x25,5	
C408	2201-000469	C-CERAMIC,DISC	0.33nF,10%,500V,Y5P,TP,5	
C409	2306-000147	C-FILM,MPPF	1uF,5%,250V,BK,26x24x15,22.5	
C410	2401-000025	C-AL	100uF,20%,16V,GP,TP,6.3x11,5	
C411	2301-000005	C-FILM,PEF	33nF,5%,100V,TP,5.8x12.5x3,5	
C412	2301-000148	C-FILM,PEF	10nF,5%,100V,TP,7x3.2x7mm,5mm	
C413	2401-001012	C-AL	3.3UF,20%,50V,BP,TP,16X25,7.5	

Loc. No.	Code No.	Description	Specification	Remarks
C414	2401-001334	C-AL	470nF,20%,50V,GP,TP,5x11,2.5	
C415	2401-001218	C-AL	4.7uF,20%,100V,WT,TP,5x11,5	
C416	2301-000010	C-FILM,PEF	100nF,5%,100V,TP,11.5x12.5mm	
C417	2301-000148	C-FILM,PEF	10nF,5%,100V,TP,7x3.2x7mm,5mm	
C419	2309-000106	C-FILM,MPE-PPF	2.2nF,5%,1.6KV,TP,23x16x9	⚠
C420	2309-000107	C-FILM,MPE-PPF	2.5nF,5%,1.6KV,BK,23x17x1	⚠
C421	2303-001029	C-FILM,PPF	5.2nF,5%,630V,TP,19x7x13,7.5	
C423	2401-000603	C-AL	1uF,20%,50V,GP,TP,5x11,5	
C425	2306-000119	C-FILM,MPPF	100nF,5%,250V,TP,19x14.5x6.5	
C426	2401-000603	C-AL	1uF,20%,50V,GP,TP,5x11,5	
C427	2306-000164	C-FILM,MPPF	220nF,5%,250V,TP,19x22x10,7	
C429	2401-000603	C-AL	1uF,20%,50V,GP,TP,5x11,5	
C430	2306-000249	C-FILM,MPPF	680nF,5%,250V,TP,26x20.5x12	
C431	2306-000179	C-FILM,MPPF	300nF,5%,250V,TP,20x18.5x10	
C432	2305-001033	C-FILM,MPEF	15nF,10%,250V,TP,13X9.0X4.5mm	
C433	2305-001003	C-FILM,MPEF	10nF,5%,250V,TP,13x4.5x9mm,7	
C434	2401-001016	C-AL	3.3uF,20%,50V,BP,TP,5X11,5	
C435	2201-000469	C-CERAMIC,DISC	0.33nF,10%,500V,Y5P,TP,5	
C501	2301-000016	C-FILM,PEF	22nF,5%,100V,TP,7.2x4.5x9.0mm	
C502	2301-000016	C-FILM,PEF	22nF,5%,100V,TP,7.2x4.5x9.0mm	
C503	2401-000050	C-AL	10uF,20%,16V,GP,TP,5x11,2.5	
C504	2301-000004	C-FILM,PEF	2.2nF,5%,100V,TP,5.5X10X2.9,5	
C505	2401-000059	C-AL	220nF,20%,50V,GP,5x11,5	
C507	2201-000291	C-CERAMIC,DISC	1nF,10%,500V,Y5P,TP,7.5x3	
C508	2401-002267	C-AL	2.2uF,20%,250V,GP,TP,8x11.5,5	
C509	2401-002267	C-AL	2.2uF,20%,250V,GP,TP,8x11.5,5	
C510	2301-000005	C-FILM,PEF	33nF,5%,100V,TP,5.8x12.5x3,5	
C511	2301-000519	C-FILM,PEF	3.3nF,5%,100V,TP,5.8x3x12.5,5	
C512	2201-000020	C-CERAMIC,DISC	10nF,10%,1kV,Y5P,BK,18x5	
C513	2201-000291	C-CERAMIC,DISC	1nF,10%,500V,Y5P,TP,7.5x3	
C514	2401-001334	C-AL	470nF,20%,50V,GP,TP,5x11,2.5	
C515	2301-000148	C-FILM,PEF	10nF,5%,100V,TP,7x3.2x7mm,5mm	
C551	2401-000050	C-AL	10uF,20%,16V,GP,TP,5x11,2.5	
C552	2201-000132	C-CERAMIC,DISC	0.1nF,10%,500V,Y5P,TP,6,5	
C601	2301-001195	C-FILM,MPPF	150nF,10%,275VAC,BK,26x16.5x	⚠
C602	2301-001195	C-FILM,MPPF	150nF,10%,275VAC,BK,26x16.5x	⚠
C603	2201-000023	C-CERAMIC,DISC	2.2nF,20%,125V,Y5U,TP,11x	⚠
C604	2201-000023	C-CERAMIC,DISC	2.2nF,20%,125V,Y5U,TP,11x	⚠
C605	2305-001041	C-FILM,MPEF	220nF,5%,63V,TP,7.5x4.5x13.5	
C607	2202-002009	C-CERAMIC,MLC-AXIAL	100nF,+80-20%,50V,Y5	
C608	2401-003367	C-AL	180uF,20%,400V,GP,BK,25x35mm,1	
C609	2401-000971	C-AL	22uF,20%,50V,WT,TP,6x11mm,5mm	
C610	2301-000284	C-FILM,PEF	47nF,5%,100V,TP,8.5x12.5mm,5m	
C611	2401-000613	C-AL	1uF,20%,50V,WT,TP,5x11,5	
C612	2401-000613	C-AL	1uF,20%,50V,WT,TP,5x11,5	
C613	2201-000012	C-CERAMIC,DISC	0.22nF,10%,1kV,Y5P,TP,6,3	

Loc. No.	Code No.	Description	Specification	Remarks
C614	2201-000019	C-CERAMIC,DISC	10nF,+80-20%,500V,Y5V,TP	
C615	2201-000291	C-CERAMIC,DISC	1nF,10%,500V,Y5P,TP,7.5x3	
C616	2201-000023	C-CERAMIC,DISC	2.2nF,20%,125V,Y5U,TP,11x	⚠
C617	2201-000023	C-CERAMIC,DISC	2.2nF,20%,125V,Y5U,TP,11x	⚠
C618	2401-000039	C-AL	1000uF,20%,16V,GP,TP,10x16,5	
C619	2201-000469	C-CERAMIC,DISC	0.33nF,10%,500V,Y5P,TP,5	
C620	2401-000540	C-AL	150uF,20%,63V,LZ,TP,10x25,5	
C621	2401-001551	C-AL	47uF,20%,35V,GP,TP,6.3x11,5	
C622	2401-000039	C-AL	1000uF,20%,16V,GP,TP,10x16,5	
C623	2401-000039	C-AL	1000uF,20%,16V,GP,TP,10x16,5	
C626	2401-000025	C-AL	100uF,20%,16V,GP,TP,6.3x11,5	
C627	2401-000292	C-AL	100uF,20%,16V,WT,TP,8x11.5mm,5	
C630	2401-001561	C-AL	47uF,20%,35V,WT,TP,8x11.5,5	
C631	2202-002009	C-CERAMIC,MLC-AXIAL	100nF,+80-20%,50V,Y5	
CIS	0201-001096	ADHESIVE-HM	#3748,YEL,8500CPS	
CIS	BH39-00016A	CBF-SIGNAL	1550MM,IVORY(IV01),2990	
CIS	BH72-00025A	GUIDE-POWER	CDA4507,ABS+PC,5V,IV16	
CIS	BH72-00026A	SHAFT-POWER	CDA4507,ABS+PC,5V,IV16	
CIS	0203-001199	TAPE-KRAFT	#53110,TO.1,W6,L2000M,BRN	
CIS	0402-001255	DIODE-RECTIFIER	DTV56F,1.5KV,10A,TO-220A	
CIS	0502-000465	TR-POWER	KTD2058-Y,NPN,25W,TO-220IS,ST	
CIS	0502-001129	TR-POWER	KSC5802,NPN,70W,TO-3PF,ST,5-	
CIS	1204-001508	IC-VERTICALDEF.	KA2142,SIP,10P,PLASTIC	
CIS	BH13-00004A	IC-HYBRID	DP104C,TO-220-5L,5P,POWERSW	
CIS	6501-000004	CABLETIE	DA-80,T1,W2.5,L80,NTR,NYLON66	
CIS	BH61-00006A	SUPPORT-PCB	NYLON66,DP17LS	
CIS	0201-001052	ADHESIVE-CYA	NO2/TOKYO/3BCO,WHT	
CIS	0203-000005	TAPE-ACETATE	SGT730,TO.26,W19,L3000,BLK	
CIS	0204-001006	COMPOUND	KS650N,'0.9-1.1,1L,20L	
CIS	3302-000006	MAGNET-RUBBER	AF,14G,1620-1980G,0.58-0.9	
CIS	3309-000002	MAGNET-SHEET	5x20x80mm,UL94V-0,2	
CIS	6501-000004	CABLETIE	DA-80,T1,W2.5,L80,NTR,NYLON66	
CIS	BH03-10342C	CRT-SC	17,0.28D,M41QAR361X111(T4/S2),DOU	
CIS	BH27-00015A	COILDEGAUSSING-ASS'Y	290*265*1100MM,9.6	
CN201	3711-003895	CONNECTOR-HEADER	BOX,13P,1R,2mm,STRAIGHT	
CN202	3711-003873	CONNECTOR-HEADER	BOX,7P,1R,2mm,STRAIGHT	
CN301	3711-001483	CONNECTOR-HEADER	NOWALL,3P,1R,5.0mm,STRA	
CN302	BH71-40300A	PIN-HINGE	BRASS,D2.36,SN,HEAT/SINK	
CN303	BH71-40300A	PIN-HINGE	BRASS,D2.36,SN,HEAT/SINK	
CN304	3711-000197	CONNECTOR-HEADER	1WALL,3P,1R,2.5mm,STRAI	
CN401	BH71-40300A	PIN-HINGE	BRASS,D2.36,SN,HEAT/SINK	⚠
CN402	BH71-40300A	PIN-HINGE	BRASS,D2.36,SN,HEAT/SINK	
CN501	BH71-40300A	PIN-HINGE	BRASS,D2.36,SN,HEAT/SINK	
CN601	3721-001028	PLUG-ACPOWER	3P,NI	⚠
D301	0402-000274	DIODE-RECTIFIER	UF4004,400V,1A,DO-41,TP	
D401	0402-000274	DIODE-RECTIFIER	UF4004,400V,1A,DO-41,TP	
D402	0401-000005	DIODE-SWITCHING	1N4148,100V,200MA,DO-35	

Loc. No.	Code No.	Description	Specification	Remarks
D403	0401-000005	DIODE-SWITCHING	1N4148,100V,200MA,DO-35	
D404	0401-000005	DIODE-SWITCHING	1N4148,100V,200MA,DO-35	
D405	0402-000274	DIODE-RECTIFIER	UF4004,400V,1A,DO-41,TP	
D406	0402-001025	DIODE-RECTIFIER	ERD07-15,1.5KV,1.5A,TP	
D407	0402-001118	DIODE-RECTIFIER	UF1G,400V,1.2A,DO-204AL	
D409	0402-001256	DIODE-RECTIFIER	SUF30JL,600V,3A,P600,BK	
D410	0402-000546	DIODE-RECTIFIER	TVR10G,400V,1.0A,DO-41,T	
D411	0402-000546	DIODE-RECTIFIER	TVR10G,400V,1.0A,DO-41,T	
D412	0402-000546	DIODE-RECTIFIER	TVR10G,400V,1.0A,DO-41,T	
D413	0402-000546	DIODE-RECTIFIER	TVR10G,400V,1.0A,DO-41,T	
D420	0401-000005	DIODE-SWITCHING	1N4148,100V,200MA,DO-35	
D421	0401-000005	DIODE-SWITCHING	1N4148,100V,200MA,DO-35	
D422	0401-000005	DIODE-SWITCHING	1N4148,100V,200MA,DO-35	
D501	0401-000005	DIODE-SWITCHING	1N4148,100V,200MA,DO-35	
D502	0401-000005	DIODE-SWITCHING	1N4148,100V,200MA,DO-35	
D503	0402-000546	DIODE-RECTIFIER	TVR10G,400V,1.0A,DO-41,T	
D504	0402-000546	DIODE-RECTIFIER	TVR10G,400V,1.0A,DO-41,T	
D505	0401-000004	DIODE-SWITCHING	1SS244,250V,200mA,DO-34	
D506	0402-000546	DIODE-RECTIFIER	TVR10G,400V,1.0A,DO-41,T	
D507	0401-000005	DIODE-SWITCHING	1N4148,100V,200MA,DO-35	
D508	0401-000005	DIODE-SWITCHING	1N4148,100V,200MA,DO-35	
D509	0401-000005	DIODE-SWITCHING	1N4148,100V,200MA,DO-35	
D510	0401-000005	DIODE-SWITCHING	1N4148,100V,200MA,DO-35	
D511	0401-000005	DIODE-SWITCHING	1N4148,100V,200MA,DO-35	
D512	0401-000005	DIODE-SWITCHING	1N4148,100V,200MA,DO-35	
D513	0401-000005	DIODE-SWITCHING	1N4148,100V,200MA,DO-35	
D601	0402-000103	DIODE-BRIDGE	D2SBA60,600V,1.5A,SIP-4,ST	⚠
D602	0401-000005	DIODE-SWITCHING	1N4148,100V,200MA,DO-35	
D604	0401-000005	DIODE-SWITCHING	1N4148,100V,200MA,DO-35	
D605	0401-000005	DIODE-SWITCHING	1N4148,100V,200MA,DO-35	
D606	0402-000546	DIODE-RECTIFIER	TVR10G,400V,1.0A,DO-41,T	
D607	0401-000005	DIODE-SWITCHING	1N4148,100V,200MA,DO-35	
D608	0402-000274	DIODE-RECTIFIER	UF4004,400V,1A,DO-41,TP	
D609	0402-000005	DIODE-RECTIFIER	31DF4,400V,3A,DO-201AD,B	
D610	0401-000005	DIODE-SWITCHING	1N4148,100V,200MA,DO-35	
D611	0402-001118	DIODE-RECTIFIER	UF1G,400V,1.2A,DO-204AL	
D612	0402-000546	DIODE-RECTIFIER	TVR10G,400V,1.0A,DO-41,T	
D614	0402-000546	DIODE-RECTIFIER	TVR10G,400V,1.0A,DO-41,T	
D615	0401-000005	DIODE-SWITCHING	1N4148,100V,200MA,DO-35	
D616	0401-000005	DIODE-SWITCHING	1N4148,100V,200MA,DO-35	
EY301	6042-000001	EYELET	ID2.2,OD2.7,L3.1,SN,BSS3-E/EH	
EY302	6042-000001	EYELET	ID2.2,OD2.7,L3.1,SN,BSS3-E/EH	
EY401	6042-000002	EYELET	ID1.5,OD2,L3.1,SN,BSS3-E/EH	
EY501	6042-000001	EYELET	ID2.2,OD2.7,L3.1,SN,BSS3-E/EH	
EY502	6042-000001	EYELET	ID2.2,OD2.7,L3.1,SN,BSS3-E/EH	
EY503	6042-000001	EYELET	ID2.2,OD2.7,L3.1,SN,BSS3-E/EH	
EY504	6042-000002	EYELET	ID1.5,OD2,L3.1,SN,BSS3-E/EH	

Loc. No.	Code No.	Description	Specification	Remarks
EY505	6042-000002	EYELET	ID1.5,OD2,L3.1,SN,BSS3-E/EH	
EY506	6042-000002	EYELET	ID1.5,OD2,L3.1,SN,BSS3-E/EH	
EY507	6042-000002	EYELET	ID1.5,OD2,L3.1,SN,BSS3-E/EH	
EY508	6042-000002	EYELET	ID1.5,OD2,L3.1,SN,BSS3-E/EH	
EY601	6042-000001	EYELET	ID2.2,OD2.7,L3.1,SN,BSS3-E/EH	
EY602	6042-000001	EYELET	ID2.2,OD2.7,L3.1,SN,BSS3-E/EH	
EY603	6042-000001	EYELET	ID2.2,OD2.7,L3.1,SN,BSS3-E/EH	
EY604	6042-000001	EYELET	ID2.2,OD2.7,L3.1,SN,BSS3-E/EH	
EY605	6042-000001	EYELET	ID2.2,OD2.7,L3.1,SN,BSS3-E/EH	
EY606	6042-000001	EYELET	ID2.2,OD2.7,L3.1,SN,BSS3-E/EH	
EY607	6042-000002	EYELET	ID1.5,OD2,L3.1,SN,BSS3-E/EH	
EY608	6042-000002	EYELET	ID1.5,OD2,L3.1,SN,BSS3-E/EH	
EY609	6042-000002	EYELET	ID1.5,OD2,L3.1,SN,BSS3-E/EH	
FBT	6502-000001	CABLECLAMP	DAWH-5NB,D15,L35,NTR,NYLON66	
FH1	3602-000001	FUSE-CLIP	30mohm	⚠
FUSE	3601-000004	FUSE-FERRULE	250V,3.15A,SB,CERAMIC,5x20m	
GT601	BH71-40300A	PIN-HINGE	BRASS,D2.36,SN,HEAT/SINK	
GT602	BH71-40300A	PIN-HINGE	BRASS,D2.36,SN,HEAT/SINK	
GT603	BH71-40300A	PIN-HINGE	BRASS,D2.36,SN,HEAT/SINK	
GT604	BH71-40300A	PIN-HINGE	BRASS,D2.36,SN,HEAT/SINK	
IC201	BH09-00006A	IC-MICOMMASKING	DP15H/17L,DM024DP15H17L0	
IC202	1103-001149	IC-EEPROM	24C041,4KBIT,DIP,8P,300MIL,10M	
IC401	1204-001509	IC-HOR./VER.PROCESSO	TDA4859,DIP,32P,400	
IC602	1203-000165	IC-POSI.ADJUSTREG.	78R12,TO-220,3P,1	
IC603	1201-000229	IC-OPAMP	324,DIP,14P,300MIL,QUAD,100V/m	
IC604	1203-000001	IC-POSI.FIXEDREG.	7805,TO-220,3P,PLAST	
IC605	1203-000495	IC-RESET	7045,TO-92,3P,PLASTIC,4.3/4	
L401	BH27-20345B	COIL-CHOKE	150uH,10%,DR1415(L-81,C:8.0)	
L402	BH27-00023A	COIL-CHOKE	120UH,+/-10%,DR1523(L-81,C:9	
L403	BH27-20343H	COIL-PEAKING	2.7MH,10%,DR8*8,TP	
L601	BH27-00007A	COIL-LINEFILTER	25MHMIN,SQE2424,BUL	
MP2.1	BH41-00012A	P.C.B-MAIN	FR-1	
OP201	0601-001147	LED	ROUND,GRN,4.75mm,565nm	
Q301	0501-000586	TR-SMALLSIGNAL	KSC945,NPN,250mW,TO-92,TP	
Q302	0501-000303	TR-SMALLSIGNAL	KSA733,PNP,250mW,TO-92,TP	
Q303	0501-000586	TR-SMALLSIGNAL	KSC945,NPN,250mW,TO-92,TP	
Q401	0501-000122	TR-SMALLSIGNAL	2N3904,NPN,625mW,TO-92,TP	
Q403	0501-000372	TR-SMALLSIGNAL	KSC2383-Y,NPN,900mW,TO-92	
Q405	0501-000303	TR-SMALLSIGNAL	KSA733,PNP,250mW,TO-92,TP	
Q406	0501-000303	TR-SMALLSIGNAL	KSA733,PNP,250mW,TO-92,TP	
Q407	0501-000010	TR-SMALLSIGNAL	KSC1008,NPN,800mW,TO-92,T	
Q412	0501-000404	TR-SMALLSIGNAL	KSD1616-Y,NPN,750mW,TO-92	
Q413	0501-000321	TR-SMALLSIGNAL	KSB1116-Y,PNP,0.75W,TO-92	
Q414	0501-000586	TR-SMALLSIGNAL	KSC945,NPN,250mW,TO-92,TP	
Q415	0501-000586	TR-SMALLSIGNAL	KSC945,NPN,250mW,TO-92,TP	
Q416	0501-000586	TR-SMALLSIGNAL	KSC945,NPN,250mW,TO-92,TP	
Q501	0501-000416	TR-SMALLSIGNAL	KSP92,PNP,625mW,TO-92,TP	

7 Electrical Parts List

Loc. No.	Code No.	Description	Specification	Remarks
Q502	0501-000143	TR-SMALLSIGNAL	2N6520,PNP,625mW,TO-92	
Q503	0501-000303	TR-SMALLSIGNAL	KSA733,PNP,250mW,TO-92,TP	
Q551	0501-000413	TR-SMALLSIGNAL	KSP44,NPN,625mW,TO-92,5	
Q601	0501-000586	TR-SMALLSIGNAL	KSC945,NPN,250mW,TO-92,TP	
Q602	0501-000122	TR-SMALLSIGNAL	2N3904,NPN,625mW,TO-92,TP	
Q604	0501-000405	TR-SMALLSIGNAL	KSD1616-Y,NPN,750mW,TO-93	
Q608	0501-000586	TR-SMALLSIGNAL	KSC945,NPN,250mW,TO-92,TP	
Q609	0501-002228	TR-SMALLSIGNAL	KTA1281,PNP,1000MW,TO-92	
Q610	0501-000586	TR-SMALLSIGNAL	KSC945,NPN,250mW,TO-92,TP	
R200	2001-000869	R-CARBON	560HM,5%,1/8W,AA,TP,1.8X3.2MM	
R201	2001-000786	R-CARBON	47KOHM,5%,1/8W,AA,TP,1.8X3.2MM	
R202	2001-000290	R-CARBON	10KOHM,5%,1/8W,AA,TP,1.8X3.2MM	
R203	2001-000734	R-CARBON	4.7KOHM,5%,1/8W,AA,TP,1.8X3.2MM	
R204	2001-000734	R-CARBON	4.7KOHM,5%,1/8W,AA,TP,1.8X3.2MM	
R206	2001-000515	R-CARBON	220OHM,5%,1/8W,AA,TP,1.8X3.2MM	
R207	2001-000869	R-CARBON	560HM,5%,1/8W,AA,TP,1.8X3.2MM	
R208	2001-000869	R-CARBON	560HM,5%,1/8W,AA,TP,1.8X3.2MM	
R209	2001-000734	R-CARBON	4.7KOHM,5%,1/8W,AA,TP,1.8X3.2MM	
R210	2001-000472	R-CARBON	2.7KOHM,5%,1/8W,AA,TP,1.8X3.2MM	
R211	2001-000904	R-CARBON	620OHM,5%,1/8W,AA,TP,1.8X3.2MM	
R212	2001-000613	R-CARBON	3.9KOHM,5%,1/8W,AA,TP,1.8X3.2MM	
R213	2001-000429	R-CARBON	1KOHM,5%,1/8W,AA,TP,1.8X3.2MM	
R214	2001-000429	R-CARBON	1KOHM,5%,1/8W,AA,TP,1.8X3.2MM	
R215	2001-000281	R-CARBON	100OHM,5%,1/8W,AA,TP,1.8X3.2MM	
R216	2001-000281	R-CARBON	100OHM,5%,1/8W,AA,TP,1.8X3.2MM	
R217	2001-000281	R-CARBON	100OHM,5%,1/8W,AA,TP,1.8X3.2MM	
R218	2001-000281	R-CARBON	100OHM,5%,1/8W,AA,TP,1.8X3.2MM	
R219	2001-000290	R-CARBON	10KOHM,5%,1/8W,AA,TP,1.8X3.2MM	
R220	2001-000281	R-CARBON	100OHM,5%,1/8W,AA,TP,1.8X3.2MM	
R221	2001-000734	R-CARBON	4.7KOHM,5%,1/8W,AA,TP,1.8X3.2MM	
R222	2001-000734	R-CARBON	4.7KOHM,5%,1/8W,AA,TP,1.8X3.2MM	
R223	2001-000038	R-CARBON	390OHM,5%,1/4W,AA,TP,2.4X6.4MM	
R224	2001-000869	R-CARBON	560HM,5%,1/8W,AA,TP,1.8X3.2MM	
R225	2001-000869	R-CARBON	560HM,5%,1/8W,AA,TP,1.8X3.2MM	
R229	2001-000281	R-CARBON	100OHM,5%,1/8W,AA,TP,1.8X3.2MM	
R230	2001-000290	R-CARBON	10KOHM,5%,1/8W,AA,TP,1.8X3.2MM	
R231	2001-000241	R-CARBON	1.5KOHM,5%,1/8W,AA,TP,1.8X3.2MM	
R232	2001-000812	R-CARBON	5.6KOHM,5%,1/8W,AA,TP,1.8X3.2MM	
R233	2001-000331	R-CARBON	12KOHM,5%,1/8W,AA,TP,1.8X3.2MM	
R234	2001-000563	R-CARBON	27KOHM,5%,1/8W,AA,TP,1.8X3.2MM	
R235	2001-000472	R-CARBON	2.7KOHM,5%,1/8W,AA,TP,1.8X3.2MM	
R236	2001-000290	R-CARBON	10KOHM,5%,1/8W,AA,TP,1.8X3.2MM	
R301	2001-000869	R-CARBON	560HM,5%,1/8W,AA,TP,1.8X3.2MM	
R302	2004-000580	R-METAL	22Kohm,1%,1/4W,AA,TP,2.4x6.4mm	
R303	2001-000890	R-CARBON	6.8KOHM,5%,1/8W,AA,TP,1.8X3.2MM	
R304	2001-000890	R-CARBON	6.8KOHM,5%,1/8W,AA,TP,1.8X3.2MM	
R306	2004-001022	R-METAL	5.6Kohm,1%,1/4W,AA,TP,2.4x6.4m	

Loc. No.	Code No.	Description	Specification	Remarks
R307	2001-001053	R-CARBON(S)	1.5OHM,5%,1/2W,AA,TP,2.4X6.4	
R308	2001-001088	R-CARBON(S)	1KOHM,5%,1/2W,AA,TP,2.4X6.4MM	
R309	2004-004014	R-METAL	2.4ohm,1%,1/4W,AA,TP,2.4x6.4mm	
R310	2004-001136	R-METAL	6.8Kohm,1%,1/4W,AA,TP,2.4x6.4m	
R311	2001-000890	R-CARBON	6.8KOHM,5%,1/8W,AA,TP,1.8X3.2MM	
R312	2001-000812	R-CARBON	5.6KOHM,5%,1/8W,AA,TP,1.8X3.2MM	
R315	2004-004014	R-METAL	2.4ohm,1%,1/4W,AA,TP,2.4x6.4mm	
R316	2001-000281	R-CARBON	1000HM,5%,1/8W,AA,TP,1.8X3.2MM	
R317	2001-000561	R-CARBON	27KOHM,5%,1/4W,AA,TP,2.4X6.4MM	
R318	2001-000766	R-CARBON	43KOHM,5%,1/8W,AA,TP,1.8X3.2MM	
R319	2001-000947	R-CARBON	7.5KOHM,5%,1/8W,AA,TP,1.8X3.2MM	
R320	2001-000331	R-CARBON	12KOHM,5%,1/8W,AA,TP,1.8X3.2MM	
R321	2001-000591	R-CARBON	3.3KOHM,5%,1/8W,AA,TP,1.8X3.2MM	
R322	2001-000890	R-CARBON	6.8KOHM,5%,1/8W,AA,TP,1.8X3.2MM	
R323	2001-000022	R-CARBON(S)	330HM,5%,1/2W,AA,TP,2.4X6.4MM	
R324	2001-000660	R-CARBON	33KOHM,5%,1/8W,AA,TP,1.8X3.2MM	
R325	2003-000805	R-METALOXIDE(S)	82ohm,5%,1W,AA,TP,3.3x9m	
R326	2003-000805	R-METALOXIDE(S)	82ohm,5%,1W,AA,TP,3.3x9m	
R402	2001-000869	R-CARBON	560HM,5%,1/8W,AA,TP,1.8X3.2MM	
R403	2004-001226	R-METAL	750ohm,1%,1/4W,AA,TP,2.4x6.4mm	
R404	2004-000498	R-METAL	2.7Kohm,1%,1/4W,AA,TP,2.4x6.4m	
R405	2001-000591	R-CARBON	3.3KOHM,5%,1/8W,AA,TP,1.8X3.2MM	
R406	2001-000522	R-CARBON	22KOHM,5%,1/8W,AA,TP,1.8X3.2MM	
R407	2001-000109	R-CARBON(S)	4700HM,5%,1/2W,AA,TP,2.4X6.4	
R408	2001-000429	R-CARBON	1KOHM,5%,1/8W,AA,TP,1.8X3.2MM	
R409	2001-000812	R-CARBON	5.6KOHM,5%,1/8W,AA,TP,1.8X3.2MM	
R410	2003-000650	R-METALOXIDE(S)	330ohm,5%,2W,AA,TP,4x12m	
R411	2001-001096	R-CARBON(S)	2.2OHM,5%,1/2W,AA,TP,2.4X6.4	
R412	2001-000290	R-CARBON	10KOHM,5%,1/8W,AA,TP,1.8X3.2MM	
R413	2001-001038	R-CARBON(S)	0.560HM,5%,1/2W,AA,TP,2.4X6	⚠
R414	2001-001038	R-CARBON(S)	0.560HM,5%,1/2W,AA,TP,2.4X6	⚠
R415	2003-000429	R-METALOXIDE(S)	1.5Kohm,5%,2W,AA,TP,4x12	
R416	2001-000107	R-CARBON(S)	150KOHM,5%,1/2W,AA,TP,2.4X6	
R417	2001-000290	R-CARBON	10KOHM,5%,1/8W,AA,TP,1.8X3.2MM	
R418	2001-000221	R-CARBON	1.2KOHM,5%,1/8W,AA,TP,1.8X3.2MM	
R419	2001-000397	R-CARBON	180KOHM,5%,1/8W,AA,TP,1.8X3.2MM	
R420	2001-000354	R-CARBON	150KOHM,5%,1/4W,AA,TP,2.4X6.4MM	
R421	BH27-20343H	COIL-PEAKING	2.7MH,10%,DR8*8,TP	
R422	2001-001006	R-CARBON	820HM,5%,1/8W,AA,TP,1.8X3.2MM	
R423	2001-000258	R-CARBON	1.8KOHM,5%,1/8W,AA,TP,1.8X3.2MM	
R424	2004-000284	R-METAL	12Kohm,1%,1/4W,AA,TP,2.4x6.4mm	
R425	2001-000044	R-CARBON	1.2KOHM,5%,1/4W,AA,TP,2.4X6.4MM	
R426	2001-000110	R-CARBON	100HM,5%,1/4W,AA,TP,2.4X6.4MM	
R427	2001-000429	R-CARBON	1KOHM,5%,1/8W,AA,TP,1.8X3.2MM	
R428	2003-000653	R-METALOXIDE(S)	330ohm,5%,3W,AA,TP,6x16m	
R429	2001-000052	R-CARBON(S)	3.3KOHM,5%,1/2W,AA,TP,2.4X6	
R430	2001-001078	R-CARBON(S)	15KOHM,5%,1/2W,AA,TP,2.4X6.4	

Loc. No.	Code No.	Description	Specification	Remarks
R431	2003-000407	R-METALOXIDE(S)	0.6ohm,5%,2W,AA,TP,4x12m	
R432	2001-000020	R-CARBON(S)	220HM,5%,1/2W,AA,TP,2.4X6.4M	
R434	2001-000290	R-CARBON	10KOHM,5%,1/8W,AA,TP,1.8X3.2MM	
R435	2001-000786	R-CARBON	47KOHM,5%,1/8W,AA,TP,1.8X3.2MM	
R436	2001-000290	R-CARBON	10KOHM,5%,1/8W,AA,TP,1.8X3.2MM	
R437	2001-000786	R-CARBON	47KOHM,5%,1/8W,AA,TP,1.8X3.2MM	
R438	2001-000290	R-CARBON	10KOHM,5%,1/8W,AA,TP,1.8X3.2MM	
R439	2001-000786	R-CARBON	47KOHM,5%,1/8W,AA,TP,1.8X3.2MM	
R440	2001-000947	R-CARBON	7.5KOHM,5%,1/8W,AA,TP,1.8X3.2MM	
R441	2001-000411	R-CARBON	18KOHM,5%,1/8W,AA,TP,1.8X3.2MM	
R443	2003-000502	R-METALOXIDE(S)	150ohm,5%,2W,AA,TP,4x12m	
R444	2003-000767	R-METALOXIDE(S)	680ohm,5%,2W,AA,TP,4x12m	
R445	2001-000019	R-CARBON(S)	100HM,5%,1/2W,AA,TP,2.4X6.4M	
R446	2001-000117	R-CARBON(S)	680HM,5%,1/2W,AA,TP,2.4X6.4M	
R447	2003-000777	R-METALOXIDE(S)	68ohm,5%,2W,AA,TP,4x12mm	
R448	2003-000777	R-METALOXIDE(S)	68ohm,5%,2W,AA,TP,4x12mm	
R449	2001-000211	R-CARBON	10HM,5%,1/4W,AA,TP,2.4X6.4MM	
R450	2001-000522	R-CARBON	22KOHM,5%,1/8W,AA,TP,1.8X3.2MM	
R451	2001-000290	R-CARBON	10KOHM,5%,1/8W,AA,TP,1.8X3.2MM	
R452	2001-000290	R-CARBON	10KOHM,5%,1/8W,AA,TP,1.8X3.2MM	
R453	2001-000290	R-CARBON	10KOHM,5%,1/8W,AA,TP,1.8X3.2MM	
R454	2003-000650	R-METALOXIDE(S)	330ohm,5%,2W,AA,TP,4x12m	
R500	2001-000435	R-CARBON	1MOHM,5%,1/8W,AA,TP,1.8X3.2MM	
R501	2001-000472	R-CARBON	2.7KOHM,5%,1/8W,AA,TP,1.8X3.2MM	
R502	2004-000979	R-METAL	47Kohm,1%,1/4W,AA,TP,2.4x6.4mm	⚠
R503	2001-000449	R-CARBON	2.2KOHM,5%,1/8W,AA,TP,1.8X3.2MM	
R504	2001-000008	R-CARBON	15KOHM,5%,1/8W,AA,TP,1.8X3.2MM	⚠
R505	2001-000241	R-CARBON	1.5KOHM,5%,1/8W,AA,TP,1.8X3.2MM	⚠
R506	2004-000657	R-METAL	27Kohm,1%,1/4W,AA,TP,2.4x6.4mm	⚠
R507	2004-000216	R-METAL	10Kohm,1%,1/4W,AA,TP,2.4x6.4mm	⚠
R508	2002-000121	R-COMPOSITION	1Mohm,10%,1/2W,AA,TP,3.5x9	
R509	2002-000121	R-COMPOSITION	1Mohm,10%,1/2W,AA,TP,3.5x9	
R510	2001-000837	R-CARBON	51KOHM,5%,1/8W,AA,TP,1.8X3.2MM	
R511	2001-000478	R-CARBON	2.70HM,5%,1/4W,AA,TP,2.4X6.4MM	
R512	2001-000786	R-CARBON	47KOHM,5%,1/8W,AA,TP,1.8X3.2MM	⚠
R513	2001-001106	R-CARBON(S)	220KOHM,5%,1/2W,AA,TP,2.4X6	
R514	2001-000837	R-CARBON	51KOHM,5%,1/8W,AA,TP,1.8X3.2MM	
R515	2001-000546	R-CARBON	270KOHM,5%,1/4W,AA,TP,2.4X6.4MM	
R516	2004-000368	R-METAL	160Kohm,1%,1/4W,AA,TP,2.4x6.4m	
R517	2001-000987	R-CARBON	820KOHM,5%,1/4W,AA,TP,2.4X6.4MM	
R518	2001-001031	R-CARBON	91KOHM,5%,1/8W,AA,TP,1.8X3.2MM	
R519	2001-000356	R-CARBON	150KOHM,5%,1/8W,AA,TP,1.8X3.2MM	
R520	2001-000241	R-CARBON	1.5KOHM,5%,1/8W,AA,TP,1.8X3.2MM	
R521	BH27-20343H	COIL-PEAKING	2.7MH,10%,DR8*8,TP	
R522	2002-000121	R-COMPOSITION	1Mohm,10%,1/2W,AA,TP,3.5x9	
R524	2001-000660	R-CARBON	33KOHM,5%,1/8W,AA,TP,1.8X3.2MM	
R525	2001-000273	R-CARBON	100KOHM,5%,1/8W,AA,TP,1.8X3.2MM	

Loc. No.	Code No.	Description	Specification	Remarks
R526	2001-000908	R-CARBON	62KOHM,5%,1/8W,AA,TP,1.8X3.2MM	
R527	2001-000864	R-CARBON	56KOHM,5%,1/8W,AA,TP,1.8X3.2MM	
R528	2001-000262	R-CARBON	1.8MOHM,5%,1/8W,AA,TP,1.8X3.2MM	
R529	2001-000429	R-CARBON	1KOHM,5%,1/8W,AA,TP,1.8X3.2MM	
R551	2001-000530	R-CARBON	240KOHM,5%,1/4W,AA,TP,2.4X6.4MM	
R552	2001-000537	R-CARBON	24KOHM,5%,1/4W,AA,TP,2.4X6.4MM	
R553	2001-001129	R-CARBON(S)	330KOHM,5%,1/2W,AA,TP,2.4X6	
R554	2001-001110	R-CARBON(S)	240KOHM,5%,1/2W,AA,TP,2.4X6	
R555	2001-000042	R-CARBON	1KOHM,5%,1/4W,AA,TP,2.4X6.4MM	
R556	2001-000890	R-CARBON	6.8KOHM,5%,1/8W,AA,TP,1.8X3.2MM	
R600	2001-001129	R-CARBON(S)	330KOHM,5%,1/2W,AA,TP,2.4X6	⚠
R601	2001-001129	R-CARBON(S)	330KOHM,5%,1/2W,AA,TP,2.4X6	⚠
R602	2001-000023	R-CARBON	470HM,5%,1/4W,AA,TP,2.4X6.4MM	
R603	2001-000290	R-CARBON	10KOHM,5%,1/8W,AA,TP,1.8X3.2MM	
R604	2001-000857	R-CARBON	560OHM,5%,1/8W,AA,TP,1.8X3.2MM	
R605	2001-000734	R-CARBON	4.7KOHM,5%,1/8W,AA,TP,1.8X3.2MM	
R606	2003-000225	R-METALOXIDE	22Kohm,5%,1W,AA,TP,4.3x12m	
R607	2003-000225	R-METALOXIDE	22Kohm,5%,1W,AA,TP,4.3x12m	
R608	2001-000281	R-CARBON	1000HM,5%,1/8W,AA,TP,1.8X3.2MM	⚠
R609	2001-000114	R-CARBON(S)	180KOHM,5%,1/2W,AA,TP,2.4X6	
R610	2001-000114	R-CARBON(S)	180KOHM,5%,1/2W,AA,TP,2.4X6	
R611	2001-001079	R-CARBON(S)	150HM,5%,1/2W,AA,TP,2.4X6.4M	
R612	2003-000738	R-METALOXIDE(S)	56Kohm,5%,2W,AA,TP,4x12m	
R614	2001-001107	R-CARBON(S)	220ohm,5%,1/2W,AA,TP,2.4x6.4	
R615	2001-001088	R-CARBON(S)	1KOHM,5%,1/2W,AA,TP,2.4X6.4M	
R617	2001-001037	R-CARBON(S)	0.390HM,5%,1/2W,AA,TP,2.4X6	
R618	2001-000429	R-CARBON	1KOHM,5%,1/8W,AA,TP,1.8X3.2MM	
R619	2003-000471	R-METALOXIDE(S)	10ohm,5%,2W,AA,TP,4x12mm	
R620	2001-000354	R-CARBON	150KOHM,5%,1/4W,AA,TP,2.4X6.4MM	
R621	2001-000989	R-CARBON	820KOHM,5%,1/8W,AA,TP,1.8X3.2MM	
R622	2001-000211	R-CARBON	10HM,5%,1/4W,AA,TP,2.4X6.4MM	
R625	2001-000786	R-CARBON	47KOHM,5%,1/8W,AA,TP,1.8X3.2MM	
R630	2001-000786	R-CARBON	47KOHM,5%,1/8W,AA,TP,1.8X3.2MM	
R631	2001-000429	R-CARBON	1KOHM,5%,1/8W,AA,TP,1.8X3.2MM	
R632	2001-000290	R-CARBON	10KOHM,5%,1/8W,AA,TP,1.8X3.2MM	
R633	2001-000211	R-CARBON	10HM,5%,1/4W,AA,TP,2.4X6.4MM	
RL601	3501-001111	RELAY-POWER	12Vdc,250mW,5A,1FormA,15mS,5	⚠
SK501	4715-000001	SURGEABSORBER	1KV,+50-10%	
SW201	3404-000244	SWITCH-TACT	15V,20mA,90-170gf,7.5x7mm,SP	
SW202	3404-000244	SWITCH-TACT	15V,20mA,90-170gf,7.5x7mm,SP	
SW203	3404-000244	SWITCH-TACT	15V,20mA,90-170gf,7.5x7mm,SP	
SW204	3404-000244	SWITCH-TACT	15V,20mA,90-170gf,7.5x7mm,SP	
SW401	3406-000002	SWITCH-ROTARY	36Vdc,200mA,SP3T	
SW601	3403-001050	SWITCH-PUSH	30V,0.3A,SPDT,ON-OFF,PCBORD	
T401	BH26-00027A	TRANS-HOR.DRIVE	35.0MH,EI1916,PL-3	⚠
T402	BH26-00028A	TRANS-H.LINEARITY	5.2UH,6P,DR1425(C:5.0)	⚠
T501	BH26-00035A	TRANS-FBT	1.0MH,13P,FUR3658,HV45,FM1	⚠

7 Electrical Parts List

Loc. No.	Code No.	Description	Specification	Remarks
T502	BH26-00022A	TRANS-FOCUS	3.0MH,6P,EI2218,SB-5S,3.0MH	⚠
T601	BH26-00020A	TRANS-POWER	390UH,16P,EER3541,PL-3,PM2	⚠
T602	BH26-30302S	TRANS-SYNC.	3-1(250UH),SB-5S,UU1116	⚠
TH601	1404-000002	THERMISTOR-PTC	9ohm,20%,TR,RECT	
TH602	1404-001020	THERMISTOR-NTC	8ohm,15%,17mW/C,BK	
TP501	6042-000002	EYELET	ID1.5,OD2,L3.1,SN,BSS3-E/EH	
X201	2801-000005	CRYSTAL-UNIT	8MHz,50ppm,28-AAM,S,35ohm,T	
ZD201	0403-000355	DIODE-ZENER	UZ5.1BSB,5.1V,4.97-5.18V,500	
ZD202	0403-000355	DIODE-ZENER	UZ5.1BSB,5.1V,4.97-5.18V,500	
ZD203	0403-000355	DIODE-ZENER	UZ5.1BSB,5.1V,4.97-5.18V,500	
ZD204	0403-000355	DIODE-ZENER	UZ5.1BSB,5.1V,4.97-5.18V,500	
ZD205	0403-000361	DIODE-ZENER	UZ6.2BSB,6.2V,5.99-6.24V,500	
ZD502	0403-001068	DIODE-ZENER	UZ4.7BSA,4.7V,4.47-4.65V,500	
ZD601	0403-000361	DIODE-ZENER	UZ6.2BSB,6.2V,5.99-6.24V,500	
ZD603	0403-001068	DIODE-ZENER	UZ4.7BSA,4.7V,4.47-4.65V,500	

7-2 Video PCB Parts

Loc. No.	Code No.	Description	Specification	Remarks
BD101	3301-000011	CORE-FERRITEBEAD	AA,3.5x1.0x5.7mm,1500	
BD102	3301-000011	CORE-FERRITEBEAD	AA,3.5x1.0x5.7mm,1500	
BD103	3301-000011	CORE-FERRITEBEAD	AA,3.5x1.0x5.7mm,1500	
C101	2202-002009	C-CERAMIC,MLC-AXIAL	100nF,+80-20%,50V,Y5	
C102	2401-001334	C-AL	470nF,20%,50V,GP,TP,5x11,2.5	
C103	2401-000037	C-AL	470uF,20%,16V,GP,TP,8x11,5.5	
C104	2202-002008	C-CERAMIC,MLC-AXIAL	10nF,+80-20%,50V,Y5V	
C105	2202-002009	C-CERAMIC,MLC-AXIAL	100nF,+80-20%,50V,Y5	
C106	2202-002009	C-CERAMIC,MLC-AXIAL	100nF,+80-20%,50V,Y5	
C107	2401-000010	C-AL	220uF,20%,16V,GP,6.3x11mm,2	
C108	2401-001459	C-AL	47uF,20%,100V,GP,TP,10x16,5,5	
C110	2401-000025	C-AL	100uF,20%,16V,GP,TP,6.3x11,5	
C111	2401-000031	C-AL	47uF,20%,16V,GP,TP,5x11,5	
C112	2401-000050	C-AL	10uF,20%,16V,GP,TP,5x11,2.5	
C113	2202-002009	C-CERAMIC,MLC-AXIAL	100nF,+80-20%,50V,Y5	
C114	2301-000014	C-FILM,PEF	6.8nF,5%,100V,TP,5.8x12.5mm,5	
C116	2301-000188	C-FILM,PEF	1nF,5%,100V,TP,10.5x12.5x6.5	
C117	2301-000188	C-FILM,PEF	1nF,5%,100V,TP,10.5x12.5x6.5	
C118	2201-000471	C-CERAMIC,DISC	0.33nF,10%,50V,Y5P,TP,4x3	
C119	2201-000291	C-CERAMIC,DISC	1nF,10%,500V,Y5P,TP,7.5x3	
C120	2201-000285	C-CERAMIC,DISC	1nF,10%,1kV,Y5P,TP,8x5,5	
C121	2301-000010	C-FILM,PEF	100nF,5%,100V,TP,11.5x12.5mm	
C122	2201-000117	C-CERAMIC,DISC	1.8nF,10%,500V,Y5P,TP,8,5	
C123	2301-000148	C-FILM,PEF	10nF,5%,100V,TP,7x3.2x7mm,5mm	
C124	2301-000148	C-FILM,PEF	10nF,5%,100V,TP,7x3.2x7mm,5mm	
C125	2401-000010	C-AL	220uF,20%,16V,GP,6.3x11mm,2.	
CB01	2202-002009	C-CERAMIC,MLC-AXIAL	100nF,+80-20%,50V,Y5	
CB02	2202-002009	C-CERAMIC,MLC-AXIAL	100nF,+80-20%,50V,Y5	
CB04	2401-000055	C-AL	1uF,20%,160V,WT,TP,3x11,5mm	
CB05	2301-000010	C-FILM,PEF	100nF,5%,100V,TP,11.5x12.5mm	
CB06	2202-002009	C-CERAMIC,MLC-AXIAL	100nF,+80-20%,50V,Y5	
CG01	2202-002009	C-CERAMIC,MLC-AXIAL	100nF,+80-20%,50V,Y5	
CG02	2202-002009	C-CERAMIC,MLC-AXIAL	100nF,+80-20%,50V,Y5	
CG03	2201-000483	C-CERAMIC,DISC	0.033nF,5%,50V,NP0,TP,5x3	
CG04	2401-000055	C-AL	1uF,20%,160V,WT,TP,3x11,5mm	
CG05	2301-000010	C-FILM,PEF	100nF,5%,100V,TP,11.5x12.5mm	
CG06	2202-002009	C-CERAMIC,MLC-AXIAL	100nF,+80-20%,50V,Y5	
CIS	0203-001199	TAPE-KRAFT	#53110,TO.1,W6,L2000M,BRN	
CIS	0203-001200	TAPE-PAPER	#53128,TO.15,W5.5,L2000M,BEIG	
CIS	BH13-00003A	IC-HYBRID	LM2437,TO-220,9P,CRTDRIVER	
CN101	3711-004228	CONNECTOR-HEADER	BOX,6P,1R,2MM,ANGLE,SN	
CN102	BH39-00015A	CBF-HARNESS	13P/14P,200MM,WHT/BLK/RED/BL	
CR01	2202-002009	C-CERAMIC,MLC-AXIAL	100nF,+80-20%,50V,Y5	
CR02	2202-002009	C-CERAMIC,MLC-AXIAL	100nF,+80-20%,50V,Y5	
CR04	2401-000055	C-AL	1uF,20%,160V,WT,TP,3x11,5mm	
CR05	2301-000010	C-FILM,PEF	100nF,5%,100V,TP,11.5x12.5mm	
CR06	2202-002009	C-CERAMIC,MLC-AXIAL	100nF,+80-20%,50V,Y5	

Loc. No.	Code No.	Description	Specification	Remarks
D101	0401-000005	DIODE-SWITCHING	1N4148,100V,200MA,DO-35	
D102	0401-000005	DIODE-SWITCHING	1N4148,100V,200MA,DO-35	
D103	0401-000005	DIODE-SWITCHING	1N4148,100V,200MA,DO-35	
DB01	0401-000005	DIODE-SWITCHING	1N4148,100V,200MA,DO-35	
DB02	0401-000005	DIODE-SWITCHING	1N4148,100V,200MA,DO-35	
DB03	0401-000004	DIODE-SWITCHING	1SS244,250V,200mA,DO-34	
DB04	0401-000004	DIODE-SWITCHING	1SS244,250V,200mA,DO-34	
DB05	0401-000005	DIODE-SWITCHING	1N4148,100V,200MA,DO-35	
DG01	0401-000005	DIODE-SWITCHING	1N4148,100V,200MA,DO-35	
DG02	0401-000005	DIODE-SWITCHING	1N4148,100V,200MA,DO-35	
DG03	0401-000004	DIODE-SWITCHING	1SS244,250V,200mA,DO-34	
DG04	0401-000004	DIODE-SWITCHING	1SS244,250V,200mA,DO-34	
DG05	0401-000005	DIODE-SWITCHING	1N4148,100V,200MA,DO-35	
DR01	0401-000005	DIODE-SWITCHING	1N4148,100V,200MA,DO-35	
DR02	0401-000005	DIODE-SWITCHING	1N4148,100V,200MA,DO-35	
DR03	0401-000004	DIODE-SWITCHING	1SS244,250V,200mA,DO-34	
DR04	0401-000004	DIODE-SWITCHING	1SS244,250V,200mA,DO-34	
DR05	0401-000005	DIODE-SWITCHING	1N4148,100V,200MA,DO-35	
EY1	6042-000002	EYELET	ID1.5,OD2,L3.1,SN,BSS3-E/EH	
EY2	6042-000001	EYELET	ID2.2,OD2.7,L3.1,SN,BSS3-E/EH	
EY3	6042-000001	EYELET	ID2.2,OD2.7,L3.1,SN,BSS3-E/EH	
G2	BH71-40300A	PIN-HINGE	BRASS,D2.36,SN,HEAT/SINK	
GND	BH71-40300A	PIN-HINGE	BRASS,D2.36,SN,HEAT/SINK	
IC101	1201-001409	IC-VIDEOAMP	2506,DIP,28P,600MIL,SINGLE	
IC104	1204-001529	IC-OSDPROCESSOR	KS2501-09,DIP,24P,300MI	
LB01	2701-000190	INDUCTOR-AXIAL	470nH,10%,4x9.8mm	
LG01	2701-000190	INDUCTOR-AXIAL	470nH,10%,4x9.8mm	
LJP1	BH39-40306D	CBF-HARNES	.80MM,BLK,1015,AWG22	
LR01	2701-000190	INDUCTOR-AXIAL	470nH,10%,4x9.8mm	
MP2.0	BH41-00013A	PCB-DISPLAY	FR-1,1LAYER,1.6T	
Q101	0501-000122	TR-SMALLSIGNAL	2N3904,NPN,625mW,TO-92,TP	
Q102	0501-000122	TR-SMALLSIGNAL	2N3904,NPN,625mW,TO-92,TP	
QB01	0501-000140	TR-SMALLSIGNAL	2N5551,NPN,625mW,TO-92	
QB02	0501-000138	TR-SMALLSIGNAL	2N5401,PNP,625mW,TO-92,TP	
QG01	0501-000140	TR-SMALLSIGNAL	2N5551,NPN,625mW,TO-92	
QG02	0501-000138	TR-SMALLSIGNAL	2N5401,PNP,625mW,TO-92,TP	
QR01	0501-000140	TR-SMALLSIGNAL	2N5551,NPN,625mW,TO-92	
QR02	0501-000138	TR-SMALLSIGNAL	2N5401,PNP,625mW,TO-92,TP	
R101	2001-000290	R-CARBON	10KOHM,5%,1/8W,AA,TP,1.8X3.2MM	
R102	2001-000281	R-CARBON	1000HM,5%,1/8W,AA,TP,1.8X3.2MM	
R103	2001-001138	R-CARBON(S)	3900HM,5%,1/2W,AA,TP,2.4X6.4	
R104	2001-001138	R-CARBON(S)	3900HM,5%,1/2W,AA,TP,2.4X6.4	
R105	2001-000290	R-CARBON	10KOHM,5%,1/8W,AA,TP,1.8X3.2MM	
R106	2001-000429	R-CARBON	1KOHM,5%,1/8W,AA,TP,1.8X3.2MM	
R107	2001-000429	R-CARBON	1KOHM,5%,1/8W,AA,TP,1.8X3.2MM	
R108	2001-000857	R-CARBON	5600HM,5%,1/8W,AA,TP,1.8X3.2MM	
R109	2001-000290	R-CARBON	10KOHM,5%,1/8W,AA,TP,1.8X3.2MM	

Loc. No.	Code No.	Description	Specification	Remarks
R110	2001-000812	R-CARBON	5.6KOHM,5%,1/8W,AA,TP,1.8X3.2MM	
R111	2001-000563	R-CARBON	27KOHM,5%,1/8W,AA,TP,1.8X3.2MM	
R113	2001-000429	R-CARBON	1KOHM,5%,1/8W,AA,TP,1.8X3.2MM	
R114	2001-000780	R-CARBON	470OHM,5%,1/8W,AA,TP,1.8X3.2MM	
R115	2001-000577	R-CARBON	2KOHM,5%,1/8W,AA,TP,1.8X3.2MM	
R116	2001-000290	R-CARBON	10KOHM,5%,1/8W,AA,TP,1.8X3.2MM	
R117	2001-000362	R-CARBON	150OHM,5%,1/8W,AA,TP,1.8X3.2MM	
R118	2001-000281	R-CARBON	100OHM,5%,1/8W,AA,TP,1.8X3.2MM	
R119	2001-000281	R-CARBON	100OHM,5%,1/8W,AA,TP,1.8X3.2MM	
R141	2001-000005	R-CARBON	390ohm,5%,1/8W,AA,TP,1.8x3.2mm	
R142	2001-000005	R-CARBON	390ohm,5%,1/8W,AA,TP,1.8x3.2mm	
R143	2001-000005	R-CARBON	390ohm,5%,1/8W,AA,TP,1.8x3.2mm	
R144	2001-000005	R-CARBON	390ohm,5%,1/8W,AA,TP,1.8x3.2mm	
RB01	2001-000969	R-CARBON	75OHM,5%,1/8W,AA,TP,1.8X3.2MM	
RB02	2001-000969	R-CARBON	75OHM,5%,1/8W,AA,TP,1.8X3.2MM	
RB03	2001-000005	R-CARBON	390ohm,5%,1/8W,AA,TP,1.8x3.2mm	
RB04	2001-000302	R-CARBON	100HM,5%,1/8W,AA,TP,1.8X3.2MM	
RB08	2001-000027	R-CARBON	100OHM,5%,1/4W,AA,TP,2.4X6.4MM	
RB09	2001-000962	R-CARBON	75KOHM,5%,1/4W,AA,TP,2.4X6.4MM	
RB10	2001-000705	R-CARBON	390HM,5%,1/2W,AA,TP,3.3X9MM	
RB11	2001-000281	R-CARBON	100OHM,5%,1/8W,AA,TP,1.8X3.2MM	
RB12	2001-000449	R-CARBON	2.2KOHM,5%,1/8W,AA,TP,1.8X3.2MM	
RB13	2001-001000	R-CARBON	82KOHM,5%,1/8W,AA,TP,1.8X3.2MM	
RG01	2001-000969	R-CARBON	75OHM,5%,1/8W,AA,TP,1.8X3.2MM	
RG02	2001-000969	R-CARBON	75OHM,5%,1/8W,AA,TP,1.8X3.2MM	
RG03	2001-000005	R-CARBON	390ohm,5%,1/8W,AA,TP,1.8x3.2mm	
RG04	2001-000302	R-CARBON	100HM,5%,1/8W,AA,TP,1.8X3.2MM	
RG05	2001-000004	R-CARBON	200KOHM,5%,1/8W,AA,TP,1.8X3.2MM	
RG08	2001-000027	R-CARBON	100OHM,5%,1/4W,AA,TP,2.4X6.4MM	
RG09	2001-000962	R-CARBON	75KOHM,5%,1/4W,AA,TP,2.4X6.4MM	
RG10	2001-000705	R-CARBON	390HM,5%,1/2W,AA,TP,3.3X9MM	
RG11	2001-000281	R-CARBON	100OHM,5%,1/8W,AA,TP,1.8X3.2MM	
RG12	2001-000449	R-CARBON	2.2KOHM,5%,1/8W,AA,TP,1.8X3.2MM	
RG13	2001-001000	R-CARBON	82KOHM,5%,1/8W,AA,TP,1.8X3.2MM	
RR01	2001-000969	R-CARBON	75OHM,5%,1/8W,AA,TP,1.8X3.2MM	
RR02	2001-000969	R-CARBON	75OHM,5%,1/8W,AA,TP,1.8X3.2MM	
RR03	2001-000005	R-CARBON	390ohm,5%,1/8W,AA,TP,1.8x3.2mm	
RR04	2001-000302	R-CARBON	100HM,5%,1/8W,AA,TP,1.8X3.2MM	
RR08	2001-000027	R-CARBON	100OHM,5%,1/4W,AA,TP,2.4X6.4MM	
RR09	2001-000962	R-CARBON	75KOHM,5%,1/4W,AA,TP,2.4X6.4MM	
RR10	2001-000705	R-CARBON	390HM,5%,1/2W,AA,TP,3.3X9MM	
RR11	2001-000281	R-CARBON	100OHM,5%,1/8W,AA,TP,1.8X3.2MM	
RR12	2001-000449	R-CARBON	2.2KOHM,5%,1/8W,AA,TP,1.8X3.2MM	
RR13	2001-001000	R-CARBON	82KOHM,5%,1/8W,AA,TP,1.8X3.2MM	
S/VID	6502-000001	CABLECLAMP	DAWH-5NB,D15,L35,NTR,NYLON66	
SK101	1405-001064	SURGEABSORBER	400V,20%,AXIAL	
SK102	4715-000001	SURGEABSORBER	1KV,+50-10%	

7 Electrical Parts List

Loc. No.	Code No.	Description	Specification	Remarks
SKB01	4715-000102	SURGEABSORBER	200V,20%,1000A,RADIAL	
SKG01	4715-000102	SURGEABSORBER	200V,20%,1000A,RADIAL	
SKR01	4715-000102	SURGEABSORBER	200V,20%,1000A,RADIAL	
V_BOTTOM	BH39-40361A	CBF-HARNESS	40MM,BLK,UL1015,AWG22	

Others

Loc. No.	Code No.	Description	Specification	Remarks	
⚠	CRT	BH03-00015A	CRT-COLOR	0.28,M41QAR361X114(T4/S-2),DYNA	
		BH03-10342B	CRT-COLOR	0.28,M41QAR361X111(A/S2),D	
	PBA UNIT	BH94-00048C	ASSY,PCB	DP17L*	
	B/D ASS'Y CODE	BH98-00036C1	ASSY,PCB/MAIN	DP17L*	
		BH98-00037C	ASSY,PCB/VIDEO	DP17L*	
	S/CABLE	BH39-00016A	CBF-SIGNAL	1550MM,IVORY(IV01),2990	
	MAGNET	3302-000006	MAGNET-RUBBER	AF,14G,1620-1980G,0.58-0.9	
		BH27-00015A	COIL DEGAUSSING-ASS'Y	290*265*1100MM,9.6	
	P/CORD	BH39-10007A	CBF POWER/CORD	DET,H05VV-F,250V/6A,IVY,1830MM	
		BH39-10339E	CBF POWER/CORD	DET,SVT,125V 7A/10A,IVY,1830MM	

7-3 Different Parts List (CDT)

Maker	SDD 0.28				TSB		Philips		Remarks
Descriptions	Mini-Neck		Normal (29Ø)		Mini-Neck		Normal (29Ø)		
R516	MF 1/4W 160K	2004-000368	MF 1/4W 150K	2004-000327	MF 1/4W 150K	2004-000327	MF 1/4W 150K	2004-000327	
R527	CF 1/8W 27K	2001-000563	CF 1/8W 47K	2001-000786	CF 1/8W 27K	2001-000563	CF 1/8W 47K	2001-000786	
R520	CF 1/8W 2.7K	2001-000472	CF 1/8W 1.5K	2001-000241	CF 1/8W 2.7K	2001-000472	CF 1/8W 1.5K	2001-000241	
R428	M.O 3W 270	2003-000608	M.O 3W 390	2003-000672	M.O 3W 270	2003-000608	M.O 3W 430	2003-000695	
R423	CF 1/8W 2.7K	2001-000472	CF 1/8W 1.8K	2001-000258	CF 1/8W 2.7K	2001-000472	CF 1/8W 1.8K	2001-000258	
R418	CF 1/8W 2.2K	2001-000449	CF 1/8W 1.2K	2001-000221	CF 1/8W 2.2K	2001-000449	CF 1/8W 1.2K	2001-000221	
R419	CF 1/8W 180K	2001-000397	CF 1/8W 200K	2001-000004	CF 1/8W 180K	2001-000397	CF 1/8W 200K	2001-000004	
R431	WW 3W 0.82	2005-001071	MO 3W 0.6	2005-000407	WW 3W 0.82	2005-001071	WW 3W 0.82	2005-001071	
R425	CF 1/4W 1K	2001-000042	CF 1/4W 1.2K	2001-000044	CF 1/4W 1K	2001-000042	CF 1/4W 1.2K	2001-000044	
R424	MF 1/4W 12K	2004-000284	MF 1/4W 12K	2004-000284	MF 1/4W 12K	2004-000284	MF 1/4W 9.1K	2004-001329	
R315, R309	MF 1/4W 3.3	2004-001814	MF 1/4W 2.4	2004-004014	MF 1/4W 3.3	2004-001814	MF 1/4W 2.4	2004-004014	
R211	CF 1/8W 680	2001-000613	CF 1/8W 560	2001-000857	CF 1/8W 680	2001-000613	CF 1/8W 560	2001-000857	
C415	ELE-CAP 160V 1 μ F	2401-000043	ELE-CAP 100V 4.7 μ F	2401-001218	ELE-CAP 160V 1 μ F	2401-000043	ELE-CAP 100V 4.7 μ F	2401-001218	
C620, C407	ELE-CAP 63V 150 μ F	2401-000540	ELE-CAP 100V 120 μ F	—	ELE-CAP 63V 150 μ F	2401-000540	ELE-CAP 100V 120 μ F	—	
Q402	IRF640	0505-001309	IRF634	0505-001181	IRF640	0505-001309	IRF634	0505-001181	
T401	HDT	BH26-00027A	HDT(N)	—	HDT	BH26-00027A	HDT(N)	—	
T501	TRANS FBT(SEMCO)	BH26-00025A	TRANS FBT(SEMCO)	BH26-00037A	TRANS FBT(SEMCO)	BH26-00025A	TRANS FBT(SEMCO)	BH26-00037A	
T601	TRANS POWER (45V)	BH26-00021A	TRANS POWER (52V)	BH26-00046A	TRANS POWER (45V)	BH26-00021A	TRANS POWER (52V)	BH26-00046A	
SK01	SDD MINI SOCKET	3704-001081	NORMAL SOCKET	3704-001014	TSB MINI SOCKET	3704-001042	NORMAL SOCKET	3704-001014	

8 Block Diagrams

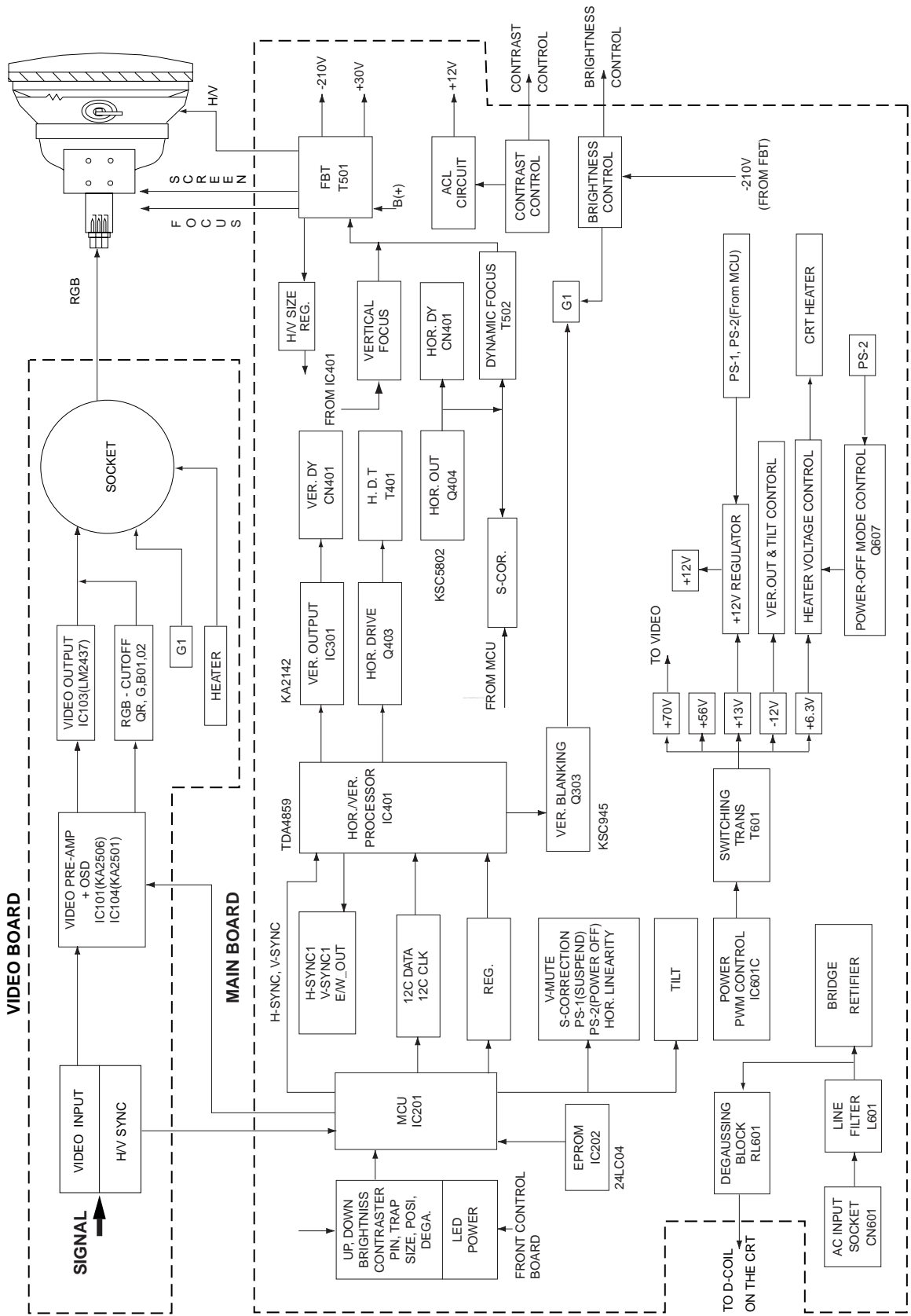

Memo

9 Wiring Diagram

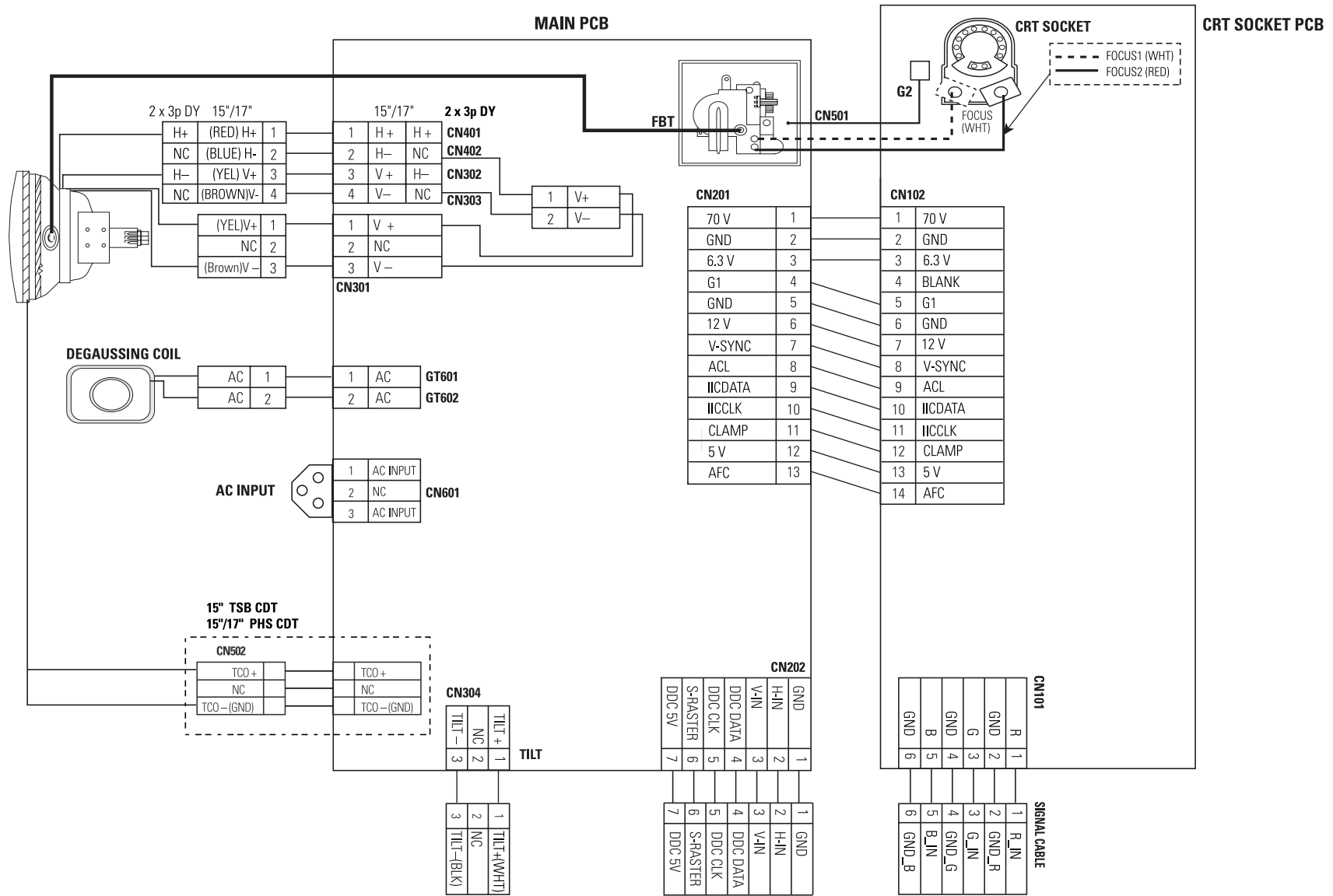

15 PIN
D-SUB
refer to pin
assignment
of
product spec.

10 Schematic Diagrams

10-1 SMPS Part Schematic Diagram

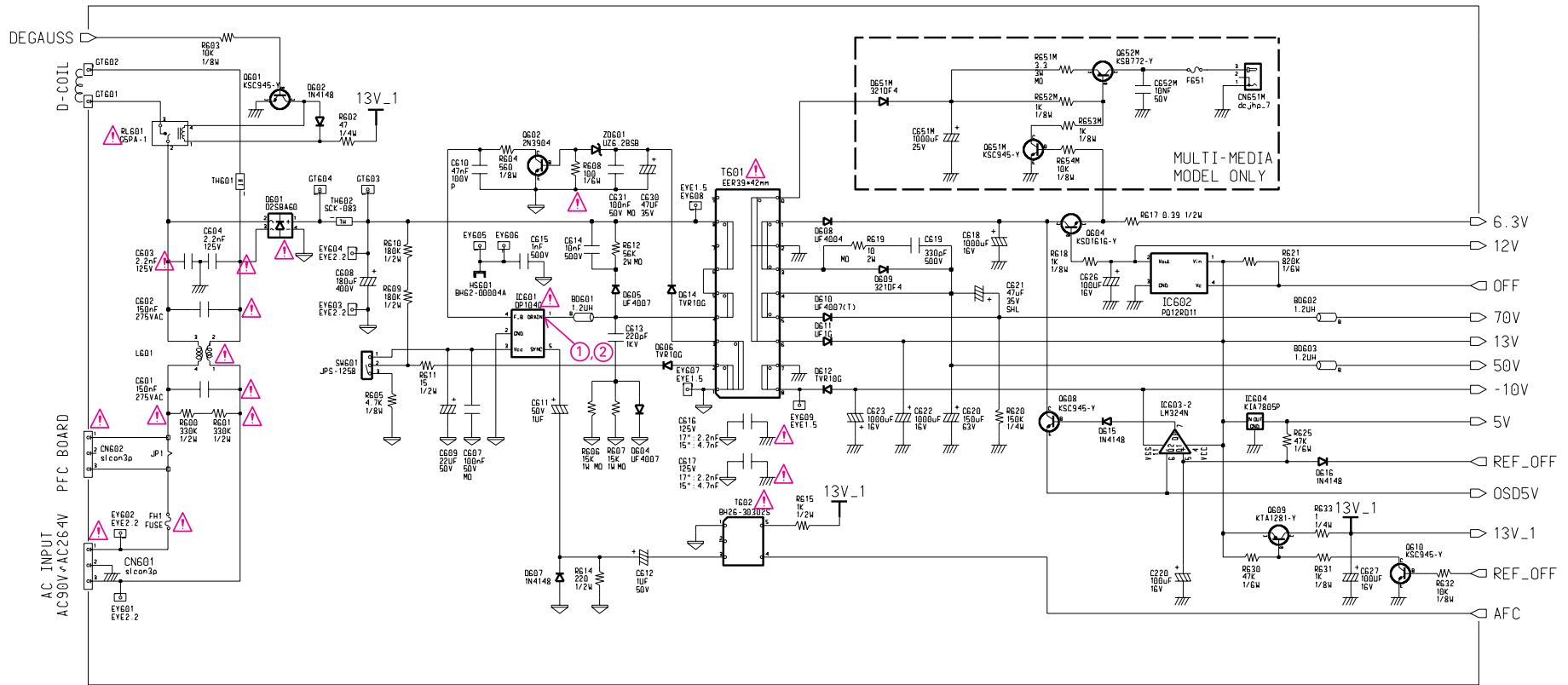

Table 10-1. IC601 (DP104C)

Pin #	MODES	
	1024 x 768 / 85 Hz	640 x 480 / 60 Hz
1	285 V	286 V
2	0.8 mV	0.6 mV
3	18.1 V	18.0 V
4	1.51 V	2.01 V
5	4.98 V	4.98

Unit: Vrms

Table 10-2. IC602 (78R12)

Pin #	MODES	
	1024 x 768 / 85 Hz	640 x 480 / 60 Hz
1	13.57 V	13.50
2	12.05	12.05
3	-17.0 mV	-15.5 mV
4	4.99 V	4.99 V

Unit: Vrms

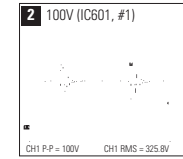
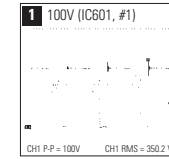

10-2 Micom Part Schematic Diagram

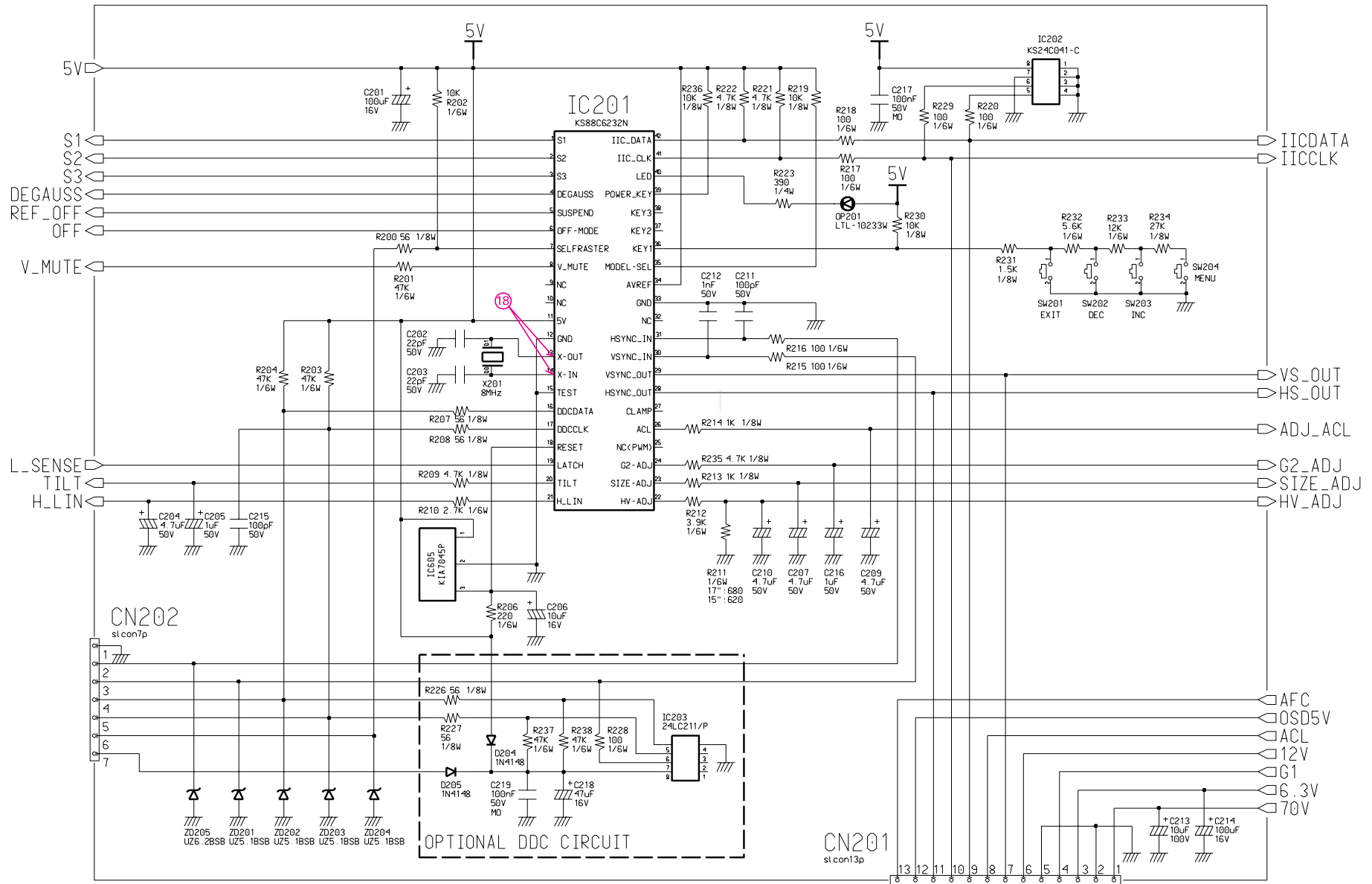
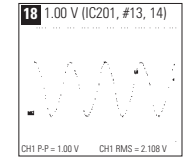

Table 10-3. IC201 (KS88C6231N)

# Pin #	MODES		# Pin #	MODES	
	1024 x 768 / 85 Hz	640 x 480 / 60 Hz		1024 x 768 / 85 Hz	640 x 480 / 60 Hz
1	5.01 V	0.47 mV	22	1.02 V	1.02 V
2	5.01 V	-2.0 mV	23	2.91 V	0.31 V
3	5.01 V	-3.2 mV	24	1.14 V	1.04 V
4	-4.9 mV	-4.4 mV	25	7.5 mV	-8.7 mV
5	5.00 V	5.00 V	26	3.99 V	3.99 V
6	4.9 V	4.90 V	27	4.93 V	5.0 V
7	31.2 mV	30.8 mV	28	4.73 V	4.49 V
8	7.96 mV	-7.4 mV	29	11.3 mV	-11.4 mV
9	9.1 mV	-8.5 mV	30	4.5 mV	4.49 V
10	9.9 mV	-9.4 mV	31	0.314 V	3.98 V
11	5.12 V	5.12 V	32	15.3 mV	-14.6 mV
12	15.3 mV	-14.5 mV	33	15.6 mV	-14.8 mV
13	1.13 V	1.13 V	34	5.12 V	5.12 V
14	1.68 V	1.70 V	35	5.11 V	5.11 V
15	15.5 mV	-14 mV	36	5.11 V	5.11 V
16	4.13 mV - 3.9 V	41.3 V - 3.9 V	37	5.11 V	5.11 V
17	3.66 V	3.67 V	38	5.11 V	5.11 V
18	4.99 V	4.99 V	39	5.11 V	5.11 V
19	4.31 V	4.34 V	40	0.145 V	0.146 V
20	2.49 V	2.49 V	41	5.12 V	5.12 V
21	2.44	0.6 V	42	5.12	5.12 V

Unit: Vrms



10-3 H/V OSC & Vertical Part Schematic Diagram

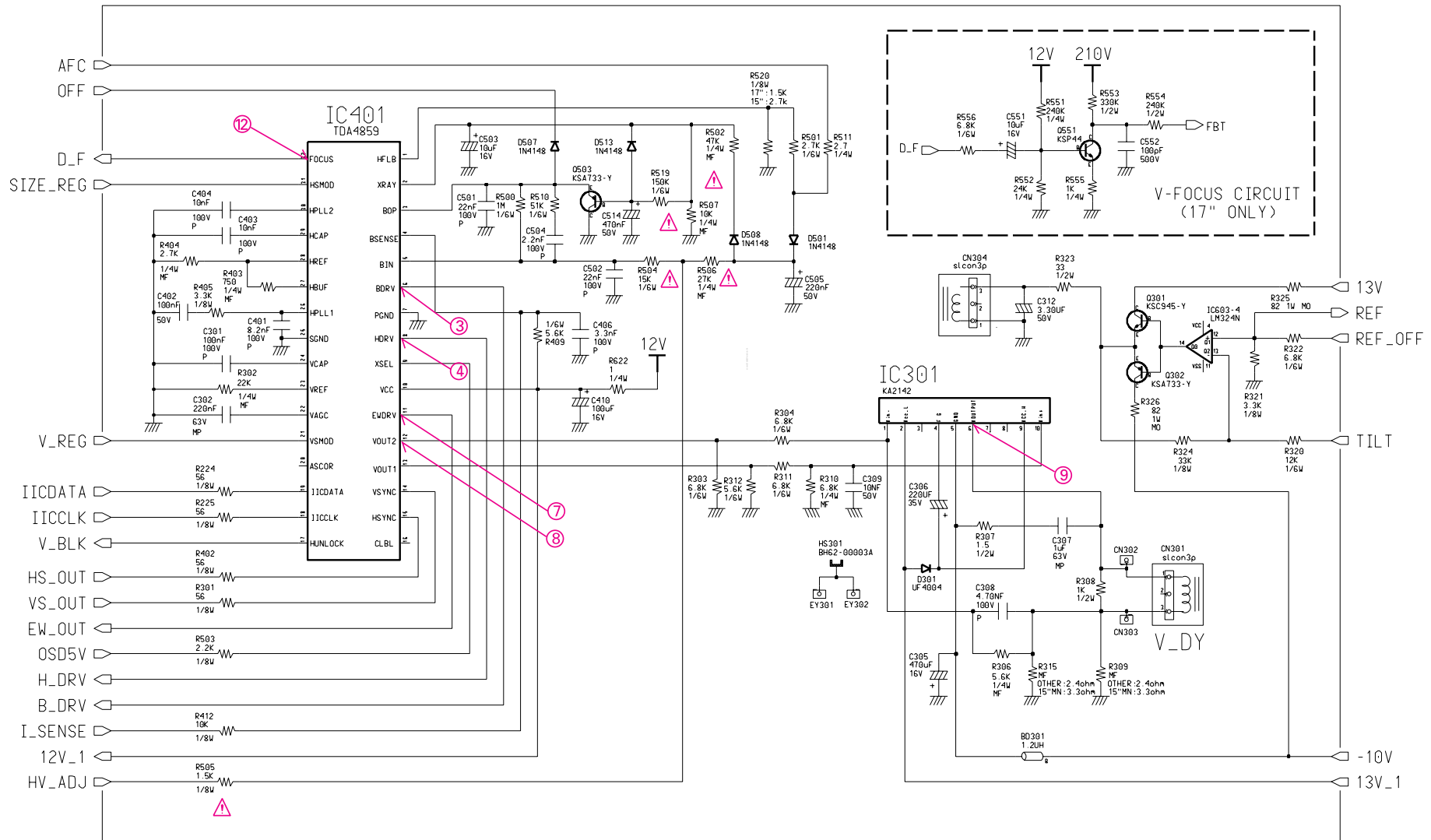

10 Schematic Diagrams

Table 10-5. IC301 (KA2142)

Pin #	MODES	
	800 x 600 / 85 Hz	640 x 480 / 60 Hz
1	0.64	0.64
2	13.2	13.0
3	1.5 mV	0.1 mV
4	-10.5	-10.6
5	-11.0	-10.9
6	-3.9 mV	-1.6 mV
7	0 mV	0.1 mV
8	0.1 mV	0.1 mV
9	12.9 V	12.6 V
10	0.64 V	0.64 V

Unit: Vrms

Table 10-6. IC603 (LM324N)

Pin #	MODES	
	1024 x 768 / 85 Hz	640 x 480 / 60 Hz
1	12.01	11.8
2	3.06	3.60
3	5.12	5.12
4	13.5	13.3
5	5.12	5.11
6	5.12	5.12
7	6.51	6.43
8	0.66	3.96
9	1.63	1.63
10	1.63	1.63
11	11.19	-11.1
12	1.63	1.63
13	1.63	1.63
14	0.70	-0.68

Unit: Vrms

Table 10-7 IC401 (TDA4859)

Pin #	MODES		Pin #	MODES	
	1024 x 768 85 Hz	640 x 480 / 60 Hz		1024 x 768 85 Hz	640 x 480 / 60 Hz
1	0.33 V	-0.15 V	17	24.7 mV	23.9 mV
2	5.64 V	5.68 V	18	5.12 V	5.12 V
3	4.45 V	3.89 V	19	5.12 V	5.12 V
4	2.15 V	1.39 V	20	4.02 V	4.04 V
5	2.48 V	2.48 V	21	5.01 V	5.01 V
6	3.54 V	6.48 V	22	2.69 V	3.17 V
7	-15.4 mV	-14.5 mV	23	3.02 V	3.03 V
8	0.964 V	0.93 V	24	2.66	2.67 V
9	2.01 V	2.02 V	25	-15.4 mV	-14.7 mV
10	11.7 V	11.7 V	26	3.86 V	3.86 V
11	2.73 V	1.86 V	27	1.54 V	2.51 V
12	1.38 V	1.38 V	28	2.57 V	2.56V
13	1.29 V	1.29 V	29	4.54 V	4.51 V
14	-11.3 mV	-11.4 mV	30	5.47 V	5.00 V
15	4.73 V	4.49 V	31	5.47 V	4.99
16	0.76 V	0.64 V	32	6.11 V	6.08

Unit: Vrms

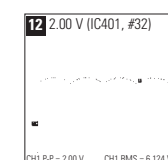
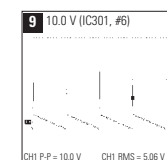
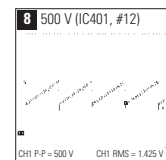
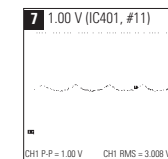
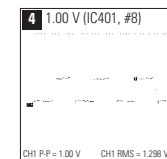
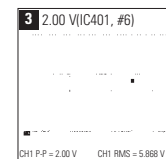

10-4 Deflection Part Schematic Diagram

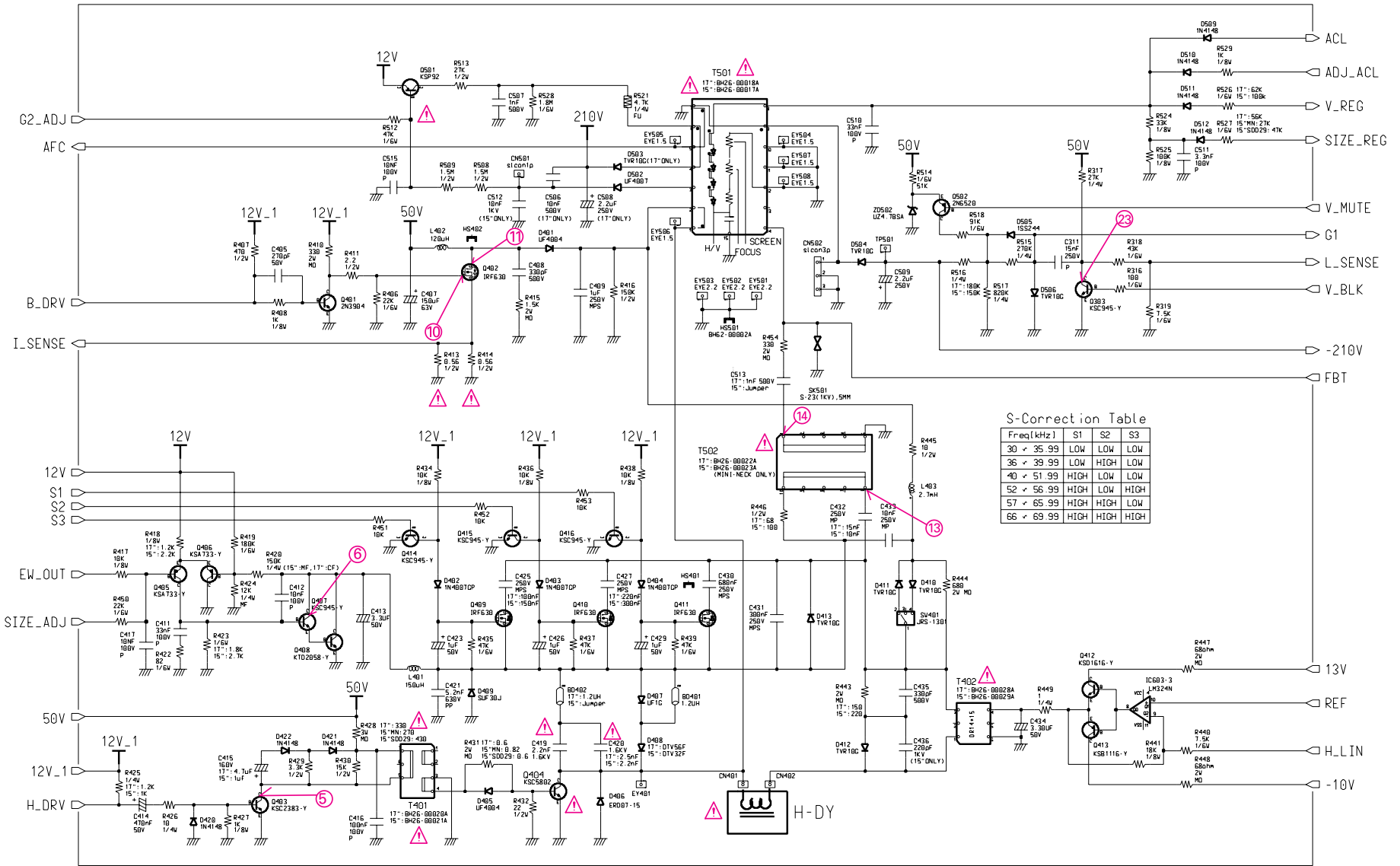

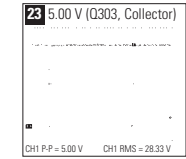
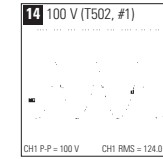
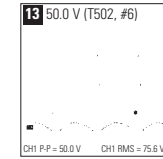
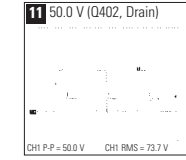
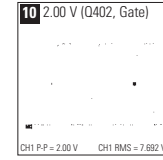
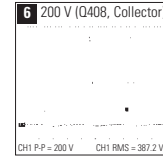
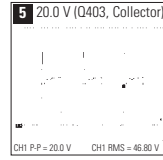

10-5 Video Part Schematic Diagram

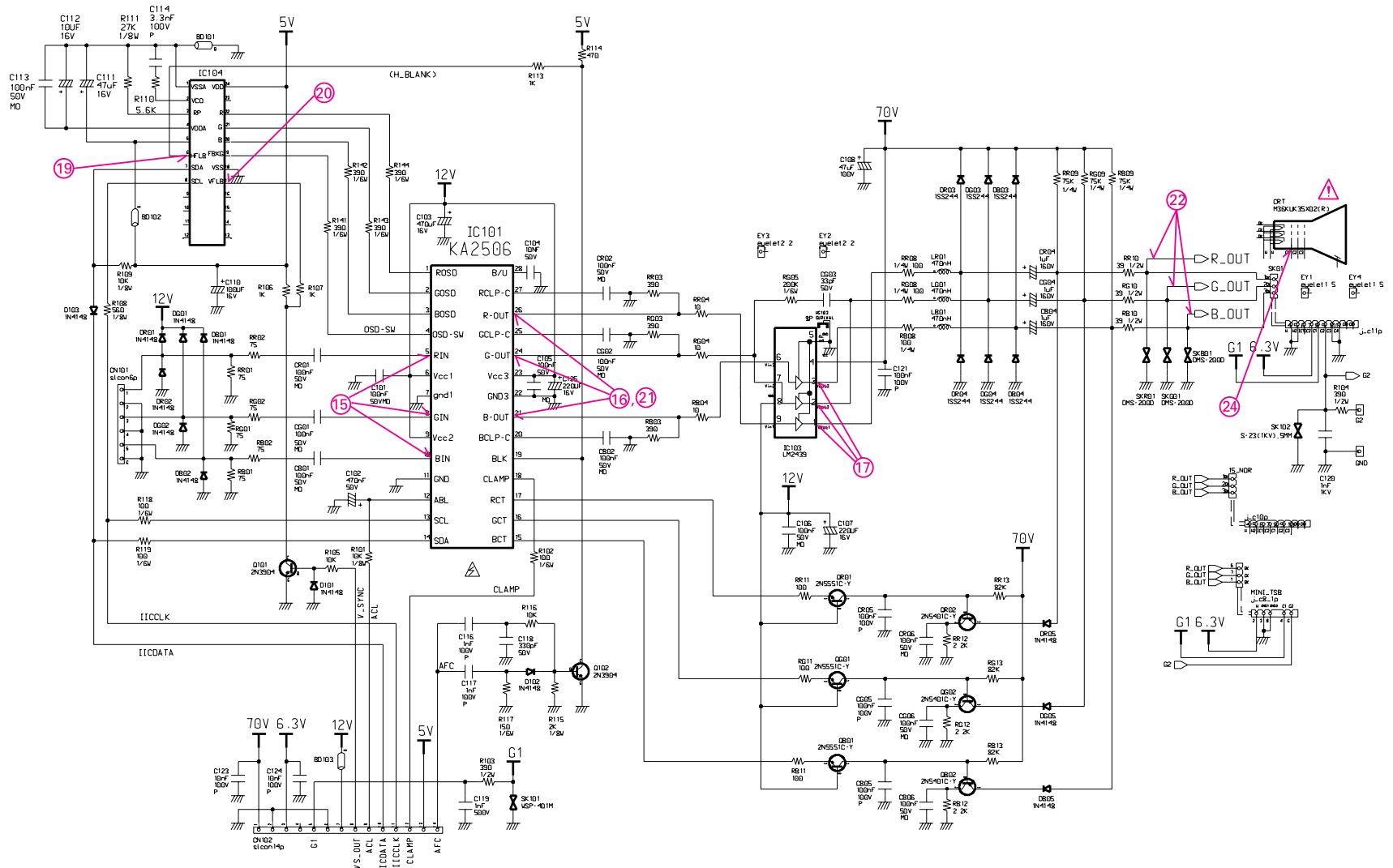

Table 10-8. IC101 (KA2506)

Pin #	MODES		Pin #	MODES	
	1024 x 768 / 85 Hz	640 x 480 / 60 Hz		1024 x 768 / 85 Hz	640 x 480 / 60 Hz
1	4.6 mV	3.2 mV	15	11.2 V	11.2 V
2	4.5 mV	3.2 mV	16	11.2 V	11.2 V
3	4.4 mV	3.0 mV	17	11.2 V	11.2 V
4	4.0 mV	2.8 mV	18	4.73 V	4.49 V
5	2.42 V	2.45 V	19	4.01 V	4.55 V
6	11.8 V	11.8 V	20	4.35 V	4.34 V
7	1.06 mV	1.0 mV	21	2.42	2.56 V
8	2.42 V	2.44 V	22	1.6 mV	1.5 mV
9	11.85 V	11.8 V	23	11.8 V	11.8 V
10	2.41 V	2.43 V	24	2.40	2.53 V
11	1.44 mV	1.39 mV	25	4.29	4.27 V
12	4.22 V	4.15 V	26	2.55	2.68 V
13	5.11 V	5.11 V	27	4.31	4.29 V
14	5.11 V	5.11 V	28	99.1 mV	99.5 mV

Unit: Vrms

Table 10-9. IC103 (LM2437)

Pin #	MODES	
	800 x 600 / 85 Hz	640 x 480 / 60 Hz
1	38.5	36.9
2	39.9	38.1
3	GND	GND
4	2.4 V	2.53
5	2.55	2.68
6	11.8	11.8
7	2.4 V	2.4 V
8	72.8	73.2
9	42.5	40.2

Unit: Vrms

Table 13-10. IC104 (KS2501 ~ 09)

Pin #	MODES	
	1024 x 768 / 85 Hz	640 x 480 / 60 Hz
1	1.3 mV	NC
2	2.24 V	NC
3	1.26 V	NC
4	1.27 V	NC
5	4.93	4.91
6	3.99	1.9 mV
7	5.11	4.9
8	5.11	5.3 V
9	NC	5.5 V
10	NC	5.6 V
11	NC	NC
12	NC	4.93

Unit: Vrms

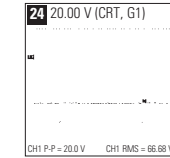
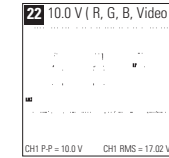
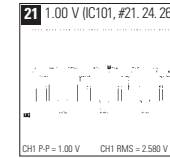
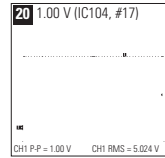
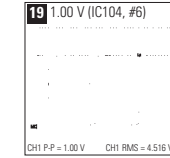
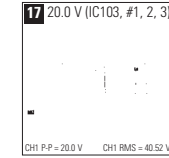
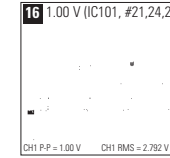
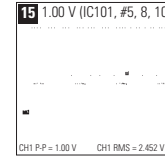

Memo