

## Features

- **Gain-bandwidth Product: 10 MHz**
- **Low Noise: 8.2 nV/ $\sqrt{\text{Hz}}$ (f= 1kHz)**
- **Slew Rate: 7 V/ $\mu\text{s}$**
- **Offset Voltage: 50  $\mu\text{V}$  (max)**
- **EMIRR IN+: 88 dB( under 2.4GHz)**
- **Low THD+N: 0.0005%**
- **Supply Range: 2.2 V to 5.5 V**
- **Supply Current: 1.4 mA/ch**
- **Low Input Bias Current: 0.3pA Typical**
- **Rail-to-Rail I/O**
- **High Output Current: 70 mA (1.0V Drop)**
- **-40°C to 125°C Operation Range**
- **Robust 6kV HBM and 2kV CDM ESD Rating**

## Applications

- Sensor Signal Conditioning
- Consumer Audio
- Multi-Pole Active Filters
- Control-Loop Amplifiers
- Communications
- Security
- Scanners

## Description

The TP2311 series products are very high precision amplifiers featuring very low noise, low offset voltage, high bandwidth, low input bias current and low temperature drift making them the ideal choice for applications requiring both high DC accuracy and AC performance. The combination of precision, low noise, and high bandwidth provides the user with outstanding value and flexibility relative to similar competitive parts.

Applications for these amplifiers include precision active filters, medical and analytical instrumentation, precision power supply controls, and industrial controls requiring high gains. Featuring low THD+N, the TP2311 series is also excellent for consumer audio applications, particularly for single-supply systems.

The TP2311 is single channel version available in 8-pin SOIC and 5-pin SOT23 packages. The TP2312 is dual channel version available in 8-pin SOIC, SOT and MSOP packages. The TP2314 is quad channel version available in 14-pin SOIC and TSSOP packages.

3PEAK and the 3PEAK logo are registered trademarks of 3PEAK INCORPORATED. All other trademarks are the property of their respective owners.

## Pin Configuration (Top View)

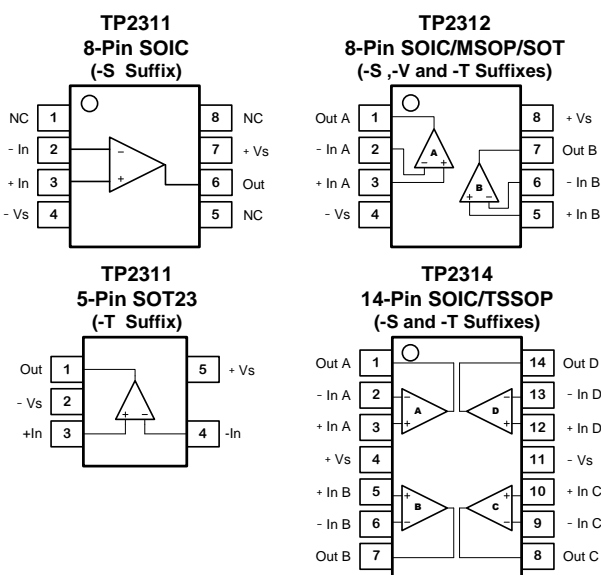

EMIRR IN+ vs. Frequency

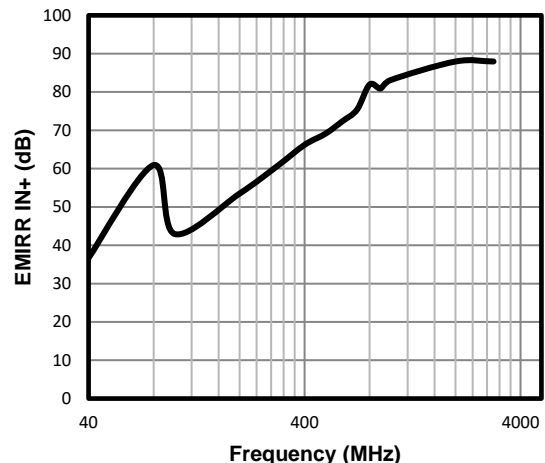

## TP2311 / TP2312 / TP2314

### 10MHz Bandwidth, Low Noise Precision Op-amps

#### Order Information

Model Name	Order Number	Package	Transport Media, Quantity	Marking Information
TP2311	TP2311-SR	8-Pin SOIC	Tape and Reel, 4,000	TP2311 XXXX <sup>Note 2</sup>
	TP2311-TR	5-Pin SOT23	Tape and Reel, 3,000	311XX <sup>Note 1</sup>
TP2312	TP2312-SR	8-Pin SOIC	Tape and Reel, 4,000	TP2312 XXXX <sup>Note 2</sup>
	TP2312-VR	8-Pin MSOP	Tape and Reel, 3,000	TP2312 XXXX <sup>Note 2</sup>
	TP2312-TR	8-Pin SOT23	Tape and Reel, 3,000	312XX <sup>Note 1</sup>
TP2314	TP2314-SR	14-Pin SOIC	Tape and Reel, 2,500	TP2314 XXXX <sup>Note 2</sup>
	TP2314-TR	14-Pin TSSOP	Tape and Reel, 3,000	TP2314 XXXX <sup>Note 2</sup>

Note 1: XX is the date code.

Note 2: XXXX is the date code.

10MHz Bandwidth, Low Noise Precision Op-amps

**Absolute Maximum Ratings** Note 1

Supply Voltage: $V^+ - V^-$ <small>Note 2</small> .....7.0V	Operating Temperature Range.....-40°C to 125°C
Input Voltage..... $V^- - 0.3$ to $V^+ + 0.3$	Maximum Junction Temperature..... 150°C
Input Current: +IN, -IN <small>Note 3</small> ..... $\pm 20$ mA	Storage Temperature Range..... -65°C to 150°C
Output Short-Circuit Duration <small>Note 4</small> ..... Indefinite	Lead Temperature (Soldering, 10 sec) ..... 260°C
Current at Supply Pins..... $\pm 60$ mA	

**Note 1:** Stresses beyond those listed under Absolute Maximum Ratings may cause permanent damage to the device. Exposure to any Absolute Maximum Rating condition for extended periods may affect device reliability and lifetime.

**Note 2:** The op amp supplies must be established simultaneously, with, or before, the application of any input signals.

**Note 3:** The inputs are protected by ESD protection diodes to each power supply. If the input extends more than 500mV beyond the power supply, the input current should be limited to less than 10mA.

**Note 4:** A heat sink may be required to keep the junction temperature below the absolute maximum. This depends on the power supply voltage and how many amplifiers are shorted. Thermal resistance varies with the amount of PC board metal connected to the package. The specified values are for short traces connected to the leads.

**ESD, Electrostatic Discharge Protection**

Symbol	Parameter	Condition	Minimum Level	Unit
HBM	Human Body Model ESD	MIL-STD-883H Method 3015.8	6	kV
CDM	Charged Device Model ESD	JEDEC-EIA/JESD22-C101E	2	kV

**Thermal Resistance**

Package Type	$\theta_{JA}$	$\theta_{JC}$	Unit
5-Pin SOT23	250	81	°C/W
8-Pin SOIC	158	43	°C/W
8-Pin MSOP	210	45	°C/W
8-Pin SOT23	196	70	°C/W
14-Pin SOIC	120	36	°C/W
14-Pin TSSOP	180	35	°C/W

# TP2311 / TP2312 / TP2314

## 10MHz Bandwidth, Low Noise Precision Op-amps

### Electrical Characteristics

The specifications are at  $T_A = 27^\circ\text{C}$ .  $V_S = +2.2\text{ V to }+5.5\text{ V}$ , or  $\pm 1.1\text{ V to } \pm 2.75\text{ V}$ ,  $R_L = 2\text{ k}\Omega$ ,  $C_L = 100\text{ pF}$ . Unless otherwise noted.

SYMBOL	PARAMETER	CONDITIONS	MIN	TYP	MAX	UNITS
$V_{OS}$	Input Offset Voltage	$V_{CM} = V_{DD}/2$	-50	$\pm 4$	+50	$\mu\text{V}$
$V_{OS\ TC}$	Input Offset Voltage Drift	$-40^\circ\text{C to }125^\circ\text{C}$		1	2	$\mu\text{V}/^\circ\text{C}$
$I_B$	Input Bias Current	$T_A = 27^\circ\text{C}$		0.3		$\text{pA}$
		$T_A = 85^\circ\text{C}$		150		$\text{pA}$
		$T_A = 125^\circ\text{C}$		300		$\text{pA}$
$I_{OS}$	Input Offset Current		0.001	0.1	$\text{pA}$	
$V_n$	Input Voltage Noise	$f = 0.1\text{ Hz to }10\text{ Hz}$		3.14		$\mu\text{V}_{PP}$
$e_n$	Input Voltage Noise Density	$f = 1\text{ kHz}$		8.2		$\text{nV}/\sqrt{\text{Hz}}$
$i_n$	Input Current Noise	$f = 1\text{ kHz}$		2		$\text{fA}/\sqrt{\text{Hz}}$
$C_{IN}$	Input Capacitance	Differential		7.76		$\text{pF}$
		Common Mode		6.87		
CMRR	Common Mode Rejection Ratio	$V_{CM} = 2.5\text{ V}$	90	106	130	$\text{dB}$
$V_{CM}$	Common-mode Input Voltage Range		$V - 0.1$		$V + 0.1$	$\text{V}$
PSRR	Power Supply Rejection Ratio	$V_{CM} = 2.5\text{ V}$	82	100	130	$\text{dB}$
$A_{VOL}$	Open-Loop Large Signal Gain	$R_{LOAD} = 1\text{ k}\Omega$	100	130	150	$\text{dB}$
$V_{OL}, V_{OH}$	Output Swing from Supply Rail	$R_{LOAD} = 100\text{ k}\Omega$	10	20	50	$\text{mV}$
$R_{OUT}$	Closed-Loop Output Impedance	$G = 1, f = 1\text{ MHz}, I_{OUT} = 0$		0.2		$\Omega$
$R_O$	Open-Loop Output Impedance	$f = 1\text{ kHz}, I_{OUT} = 0$		125		$\Omega$
$I_{SC}$	Output Short-Circuit Current	Sink or source current	100	130		$\text{mA}$
$V_{DD}$	Supply Voltage		2.2		5.5	$\text{V}$
$I_Q$	Quiescent Current per Amplifier			1.4	1.95	$\text{mA}$
PM	Phase Margin	$R_{LOAD} = 1\text{ k}\Omega, C_{LOAD} = 60\text{ pF}$		60		$^\circ$
GM	Gain Margin	$R_{LOAD} = 1\text{ k}\Omega, C_{LOAD} = 60\text{ pF}$		8		$\text{dB}$
GBWP	Gain-Bandwidth Product	$f = 1\text{ kHz}$		10		$\text{MHz}$
SR	Slew Rate	$A_V = 1, V_{OUT} = 0\text{ V to }10\text{ V}, C_{LOAD} = 100\text{ pF}, R_{LOAD} = 2\text{ k}\Omega$	3.0	7		$\text{V}/\mu\text{s}$
FPBW	Full Power Bandwidth <sup>Note 1</sup>			414		$\text{kHz}$
$t_s$	Settling Time, 0.1% Settling Time, 0.01%	$A_V = -1, 1\text{ V Step}$		0.85		$\mu\text{s}$
				0.85		
THD+N	Total Harmonic Distortion and Noise	$f = 1\text{ kHz}, A_V = 1, R_L = 2\text{ k}\Omega, V_{OUT} = 1\text{ V}_{p-p}$		0.0005		$\%$
$X_{talk}$	Channel Separation	$f = 1\text{ kHz}, R_L = 2\text{ k}\Omega$		110		$\text{dB}$

**Note 1:** Full power bandwidth is calculated from the slew rate  $\text{FPBW} = \text{SR}/\pi \cdot V_{P-P}$

10MHz Bandwidth, Low Noise Precision Op-amps

Typical Performance Characteristics

$V_S = \pm 2.75V$ ,  $V_{CM} = 0V$ ,  $R_L = \text{Open}$ , unless otherwise specified.

Offset Voltage Production Distribution

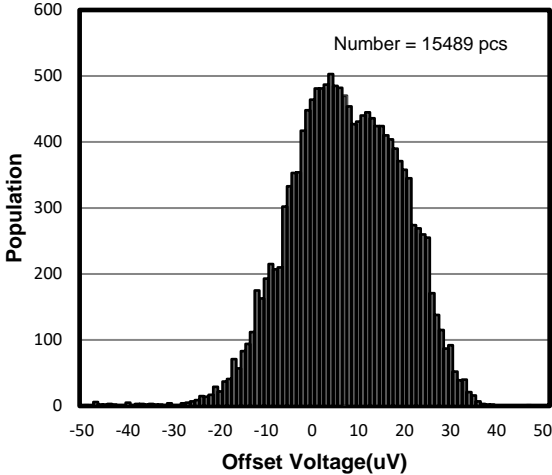

Unity Gain Bandwidth vs. Temperature

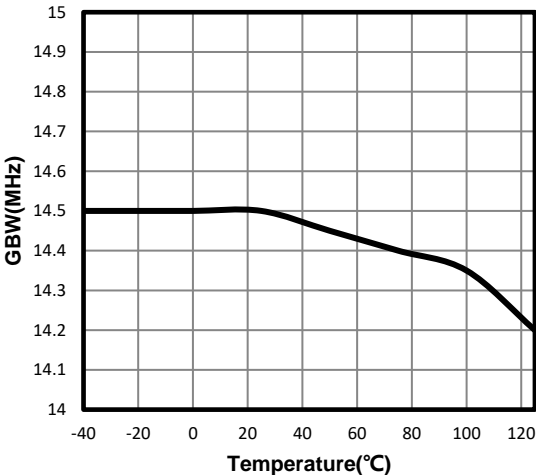

Open-Loop Gain and Phase

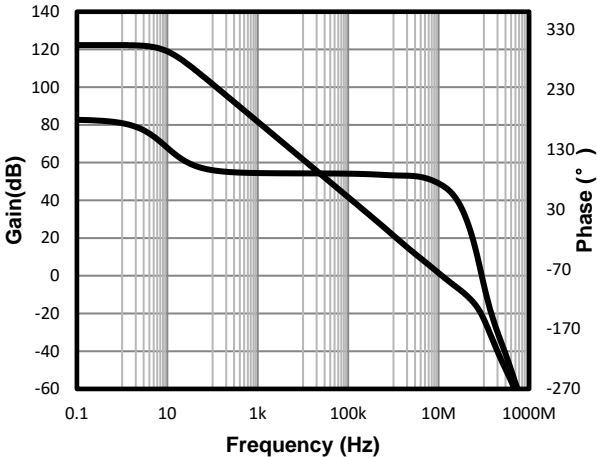

Input Voltage Noise Spectral Density

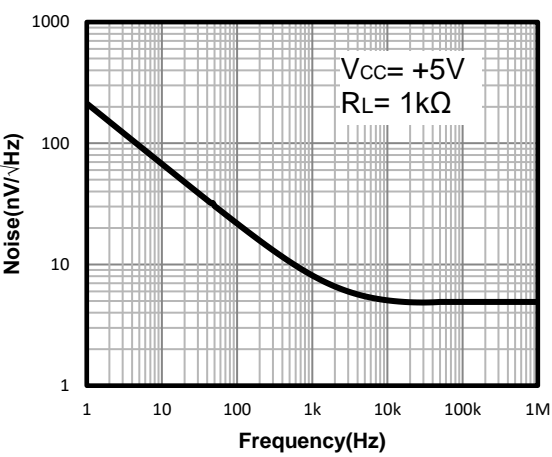

Input Bias Current vs. Temperature

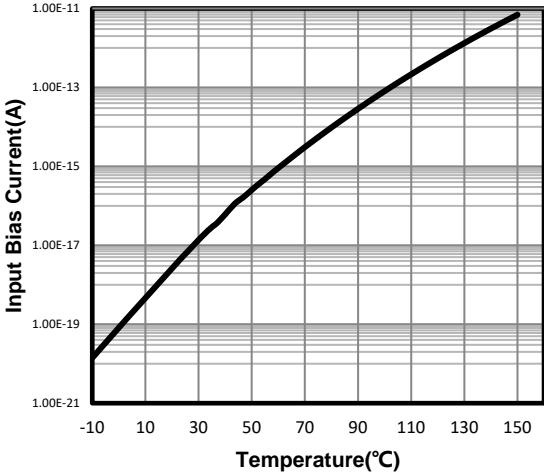

Input Bias Current vs. Input Common Mode Voltage

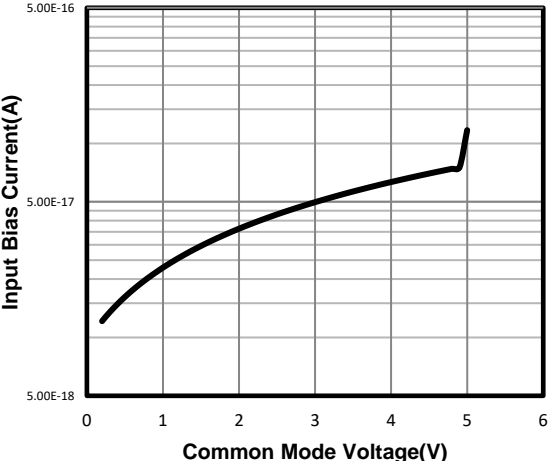

10MHz Bandwidth, Low Noise Precision Op-amps  
**Typical Performance Characteristics**

$V_S = \pm 2.75V$ ,  $V_{CM} = 0V$ ,  $R_L = \text{Open}$ , unless otherwise specified. (Continued)

Common Mode Rejection Ratio

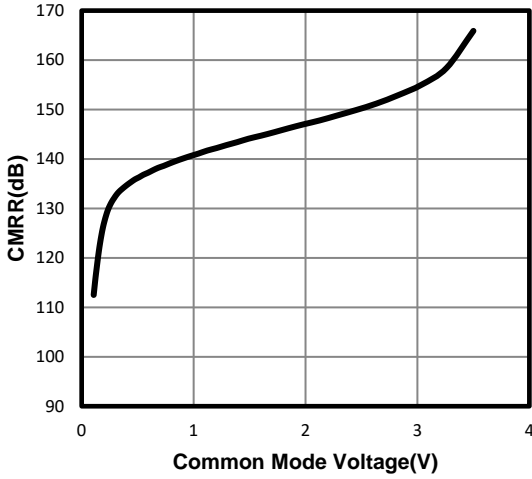

CMRR vs. Frequency

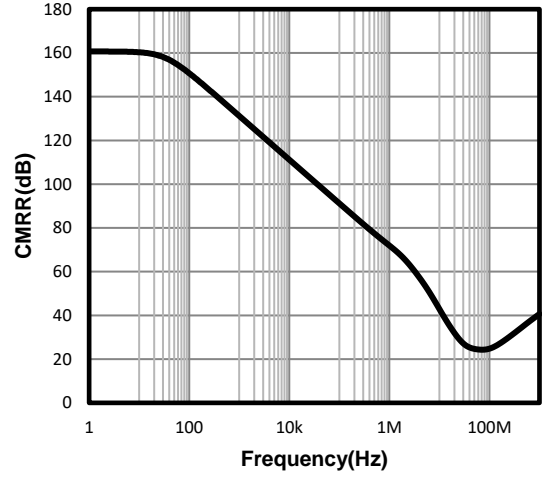

Quiescent Current vs. Temperature

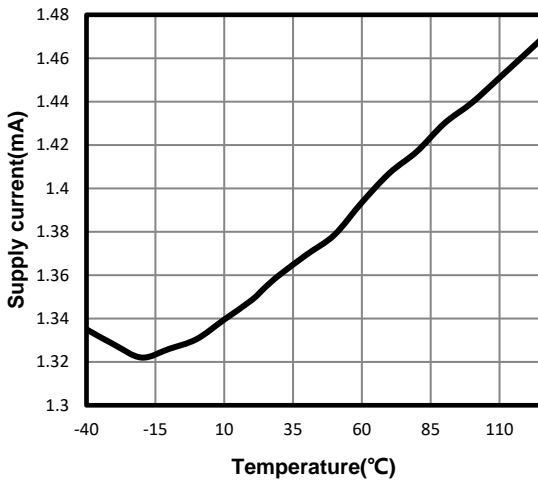

Short Circuit Current vs. Temperature

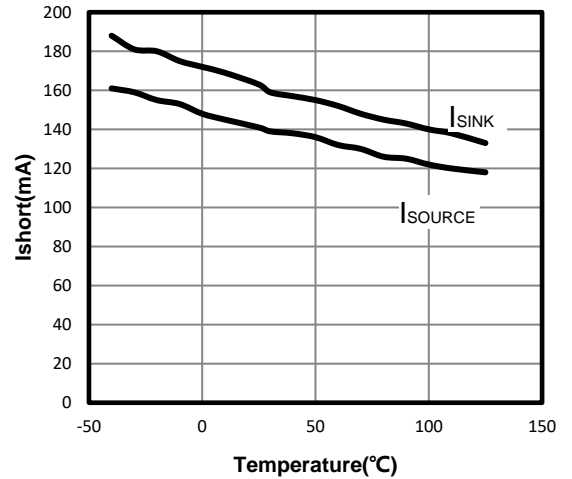

Power-Supply Rejection Ratio

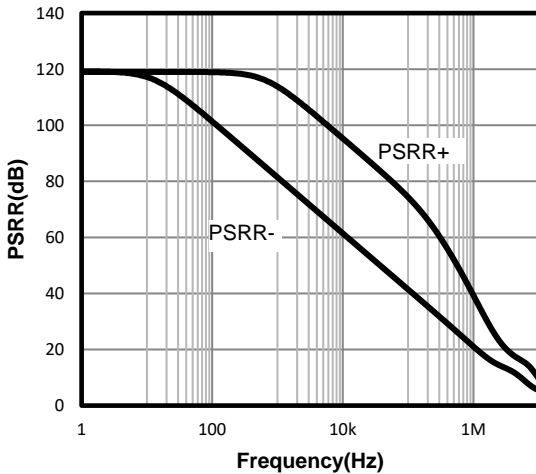

Quiescent Current vs. Supply Voltage

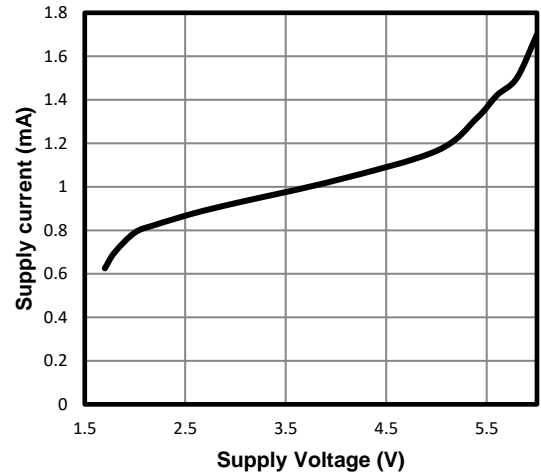

10MHz Bandwidth, Low Noise Precision Op-amps

Typical Performance Characteristics

$V_s = \pm 2.75V$ ,  $V_{CM} = 0V$ ,  $R_L = \text{Open}$ , unless otherwise specified. (Continued)

Power-Supply Rejection Ratio vs. Temperature

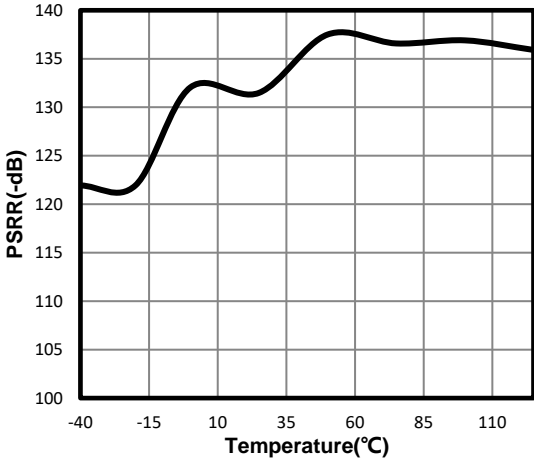

CMRR vs. Temperature

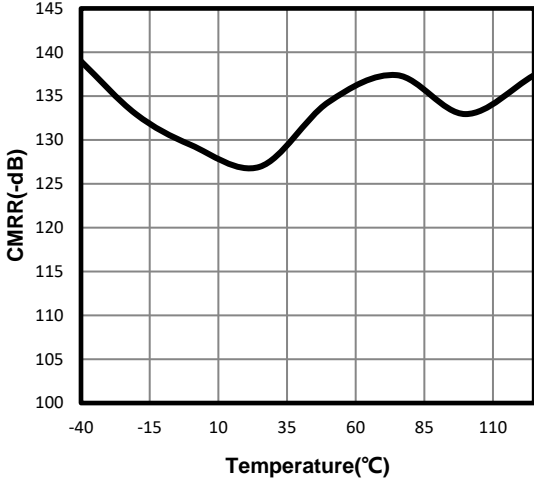

EMIRR IN+ vs. Frequency

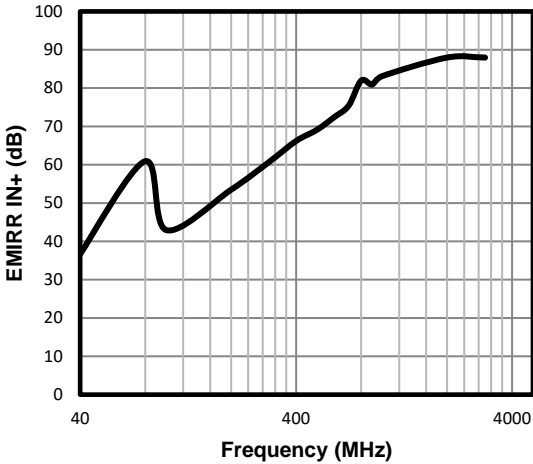

Large-Scale Step Response

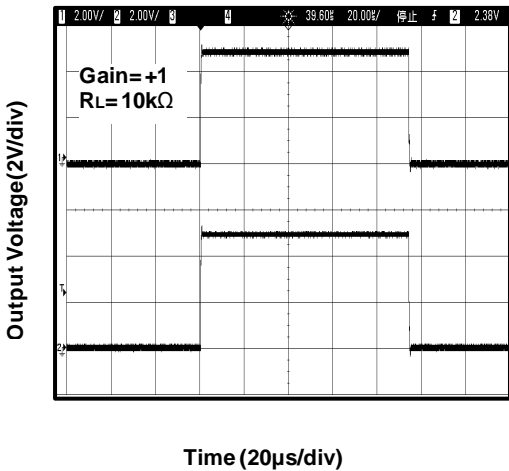

Negative Over-Voltage Recovery

Positive Over-Voltage Recovery

10MHz Bandwidth, Low Noise Precision Op-amps

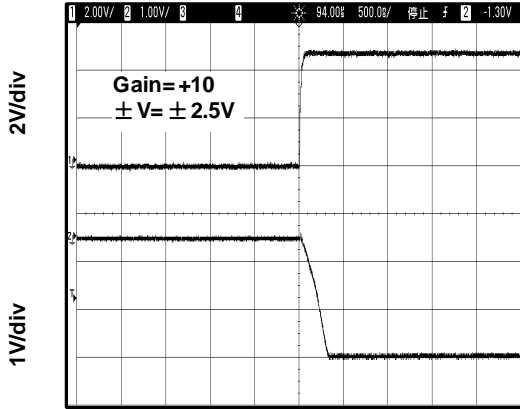

Time (500ns/div)

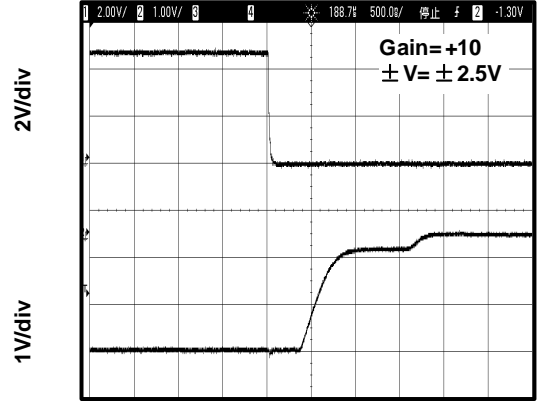

Time (500ns/div)

Typical Performance Characteristics

$V_S = \pm 2.75V$ ,  $V_{CM} = 0V$ ,  $R_L = \text{Open}$ , unless otherwise specified. (Continued)

0.1 Hz TO 10 Hz Input Voltage Noise

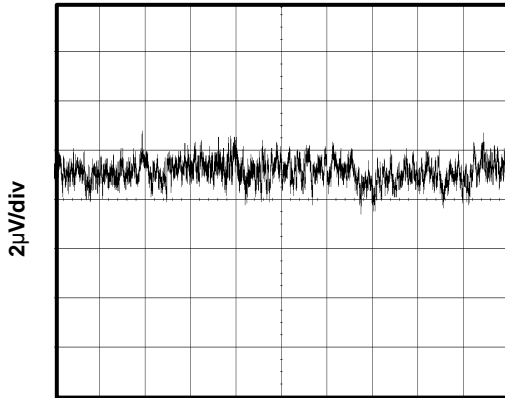

5s/div

Offset Voltage vs Common-Mode Voltage

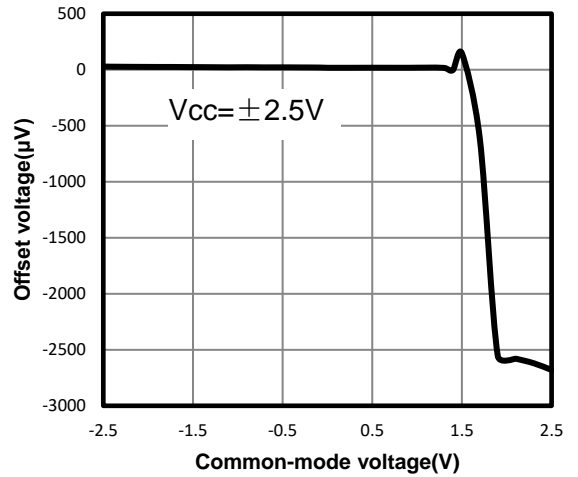

Positive Output Swing vs. Load Current

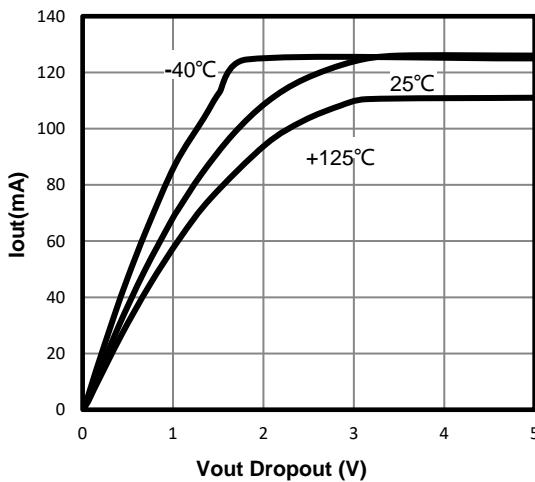

Negative Output Swing vs. Load Current

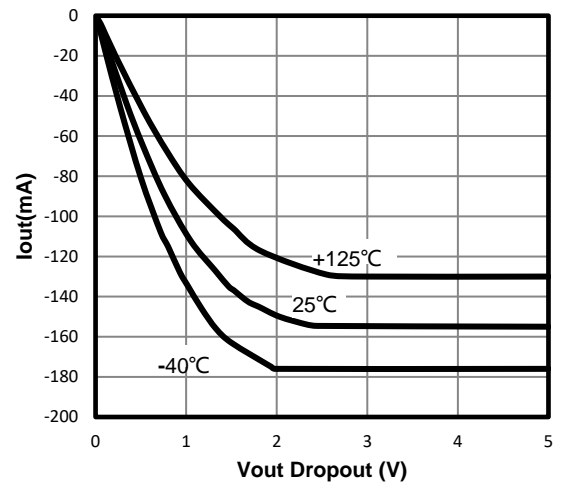



## Pin Functions

**-IN:** Inverting Input of the Amplifier.

**+IN:** Non-Inverting Input of Amplifier.

**OUT:** Amplifier Output. The voltage range extends to within mV of each supply rail.

**V+ or +Vs:** Positive Power Supply. Typically the voltage is from 2.2V to 5.5V. Split supplies are possible as long as the voltage between V+ and V- is between 2.2V and 5.5V. A bypass capacitor of 0.1 $\mu$ F as close to the part as

possible should be used between power supply pins or between supply pins and ground.

**V- or -Vs:** Negative Power Supply. It is normally tied to ground. It can also be tied to a voltage other than ground as long as the voltage between V+ and V- is from 2.2V to 5.5V. If it is not connected to ground, bypass it with a capacitor of 0.1 $\mu$ F as close to the part as possible.

## Operation

The TP2311 series op amps can operate on a single-supply voltage (2.2 V to 5.5 V), or a split-supply voltage ( $\pm 1.1$  V to  $\pm 2.75$  V), making them highly versatile and easy to use. The power-supply pins should have local bypass ceramic capacitors (typically 0.001  $\mu$ F to 0.1  $\mu$ F). These amplifiers are fully specified from +2.2 V to +5.5 V and over the extended temperature range of  $-40^{\circ}\text{C}$  to  $+125^{\circ}\text{C}$ . Parameters that can exhibit variance with regard to operating voltage or temperature are presented in the Typical Characteristics.

## Applications Information

### Input ESD Diode Protection

The TP2311 incorporates internal electrostatic discharge (ESD) protection circuits on all pins. In the case of input and output pins, this protection primarily consists of current-steering diodes connected between the input and power-supply pins. These ESD protection diodes also provide in-circuit input overdrive protection, as long as the current is limited to 10 mA as stated in the Absolute Maximum Ratings table. Many input signals are inherently current-limited to less than 10 mA; therefore, a limiting resistor is not required. Figure 1 shows how a series input resistor ( $R_S$ ) may be added to the driven input to limit the input current. The added resistor contributes thermal noise at the amplifier input and the value should be kept to the minimum in noise-sensitive applications.

10MHz Bandwidth, Low Noise Precision Op-amps

Current-limiting resistor required if input voltage exceeds supply rails by >0.5V.

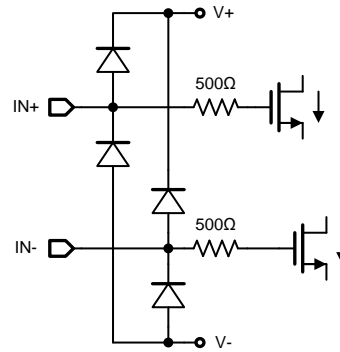
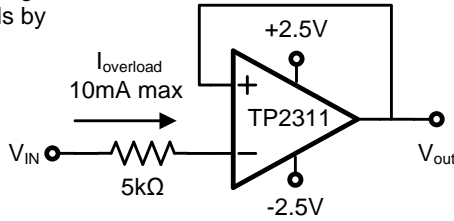

INPUT ESD DIODE CURRENT LIMITING- UNITY GAIN

Figure1. Input ESD Diode

PHASE REVERSAL

The TP2311 op amps are designed to be immune to phase reversal when the input pins exceed the supply voltages, therefore providing further in-system stability and predictability. Figure 2 shows the input voltage exceeding the supply voltage without any phase reversal.

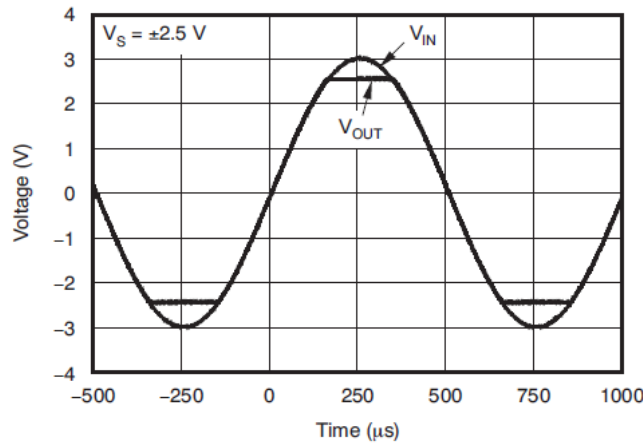

Figure 2. No Phase Reversal

EMI SUSCEPTIBILITY AND INPUT FILTERING

Operational amplifiers vary in susceptibility to electromagnetic interference (EMI). If conducted EMI enters the device, the dc offset observed at the amplifier output may shift from the nominal value while EMI is present. This shift is a result of signal rectification associated with the internal semiconductor junctions. While all operational amplifier pin functions can be affected by EMI, the input pins are likely to be the most susceptible. The TP2311 operational amplifier family incorporates an internal input low-pass filter that reduces the amplifier response to EMI. Both common-mode and differential mode filtering are provided by the input filter. The filter is designed for a cutoff frequency of approximately 500 MHz (-3 dB), with a roll-off of 20 dB per decade.

10MHz Bandwidth, Low Noise Precision Op-amps

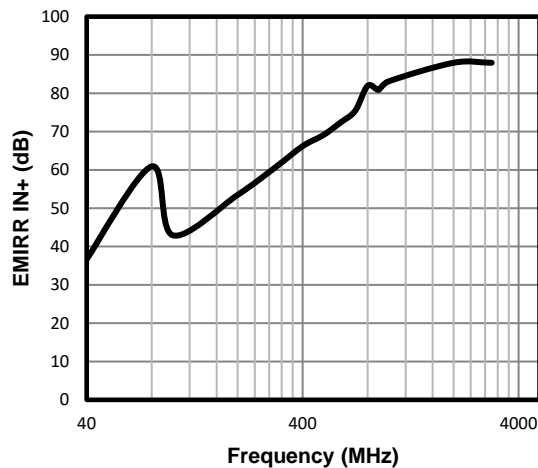

Figure 3. TP2311 EMIRR IN+ vs Frequency

ACTIVE FILTER

The TP2311 is well-suited for active filter applications that require a wide bandwidth, fast slew rate, low-noise, single-supply operational amplifier. Figure 4 shows a 20-kHz, second-order, low-pass filter using the multiple-feedback (MFB) topology. The components have been selected to provide a maximally-flat Butterworth response. Beyond the cutoff frequency, roll-off is  $-40$  dB/dec. The Butterworth response is ideal for applications that require predictable gain characteristics, such as the anti-aliasing filter used in front of an ADC.

One point to observe when considering the MFB filter is that the output is inverted, relative to the input. If this inversion is not required, or not desired, a noninverting output can be achieved through one of these options:

1. adding an inverting amplifier;
2. adding an additional second-order MFB stage;

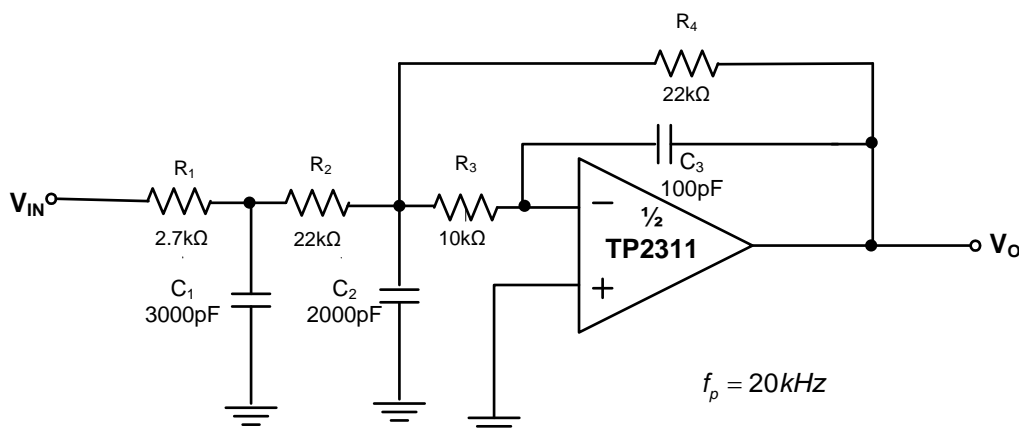

Figure 4. TP2311 Configured as a Three-Pole, 20-kHz, Sallen-Key Filter

PCB Surface Leakage

## 10MHz Bandwidth, Low Noise Precision Op-amps

In applications where low input bias current is critical, Printed Circuit Board (PCB) surface leakage effects need to be considered. Surface leakage is caused by humidity, dust or other contamination on the board. Under low humidity conditions, a typical resistance between nearby traces is  $10^{12}\Omega$ . A 5V difference would cause 5pA of current to flow, which is greater than the TP2311/2312/2314 OPA's input bias current at  $+27^\circ\text{C}$  ( $\pm 3\text{pA}$ , typical). It is recommended to use multi-layer PCB layout and route the OPA's -IN and +IN signal under the PCB surface.

The effective way to reduce surface leakage is to use a guard ring around sensitive pins (or traces). The guard ring is biased at the same voltage as the sensitive pin. An example of this type of layout is shown in Figure 1 for Inverting Gain application.

### 1. For Non-Inverting Gain and Unity-Gain Buffer:

- Connect the non-inverting pin ( $V_{IN+}$ ) to the input with a wire that does not touch the PCB surface.
- Connect the guard ring to the inverting input pin ( $V_{IN-}$ ). This biases the guard ring to the Common Mode input voltage.

### 2. For Inverting Gain and Trans-impedance Gain Amplifiers (convert current to voltage, such as photo detectors):

- Connect the guard ring to the non-inverting input pin ( $V_{IN+}$ ). This biases the guard ring to the same reference voltage as the op-amp (e.g.,  $V_{DD}/2$  or ground).
- Connect the inverting pin ( $V_{IN-}$ ) to the input with a wire that does not touch the PCB surface.

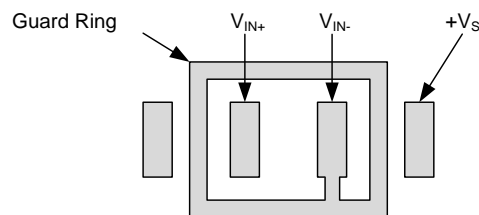

Figure 5 The Layout of Guard Ring

## Power Supply Layout and Bypass

The TP2311/2312/2314 OPA's power supply pin ( $V_{DD}$  for single-supply) should have a local bypass capacitor (i.e.,  $0.01\mu\text{F}$  to  $0.1\mu\text{F}$ ) within 2mm for good high frequency performance. It can also use a bulk capacitor (i.e.,  $1\mu\text{F}$  or larger) within 100mm to provide large, slow currents. This bulk capacitor can be shared with other analog parts.

Ground layout improves performance by decreasing the amount of stray capacitance and noise at the OPA's inputs and outputs. To decrease stray capacitance, minimize PCB board lengths and resistor leads, and place external components as close to the op amps' pins as possible.

## Proper Board Layout

To ensure optimum performance at the PCB level, care must be taken in the design of the board layout. To avoid leakage currents, the surface of the board should be kept clean and free of moisture. Coating the surface creates a barrier to moisture accumulation and helps reduce parasitic resistance on the board.

Keeping supply traces short and properly bypassing the power supplies minimizes power supply disturbances due to output current variation, such as when driving an ac signal into a heavy load. Bypass capacitors should be connected as closely as possible to the device supply pins. Stray capacitances are a concern at the outputs and the inputs of the amplifier. It is recommended that signal traces be kept at least 5mm from supply lines to minimize coupling.

**10MHz Bandwidth, Low Noise Precision Op-amps**

A variation in temperature across the PCB can cause a mismatch in the Seebeck voltages at solder joints and other points where dissimilar metals are in contact, resulting in thermal voltage errors. To minimize these thermocouple effects, orient resistors so heat sources warm both ends equally. Input signal paths should contain matching numbers and types of components, where possible to match the number and type of thermocouple junctions. For example, dummy components such as zero value resistors can be used to match real resistors in the opposite input path. Matching components should be located in close proximity and should be oriented in the same manner. Ensure leads are of equal length so that thermal conduction is in equilibrium. Keep heat sources on the PCB as far away from amplifier input circuitry as is practical.

The use of a ground plane is highly recommended. A ground plane reduces EMI noise and also helps to maintain a constant temperature across the circuit board.

# TP2311 / TP2312 / TP2314

10MHz Bandwidth, Low Noise Precision Op-amps

## Tape and Reel Information

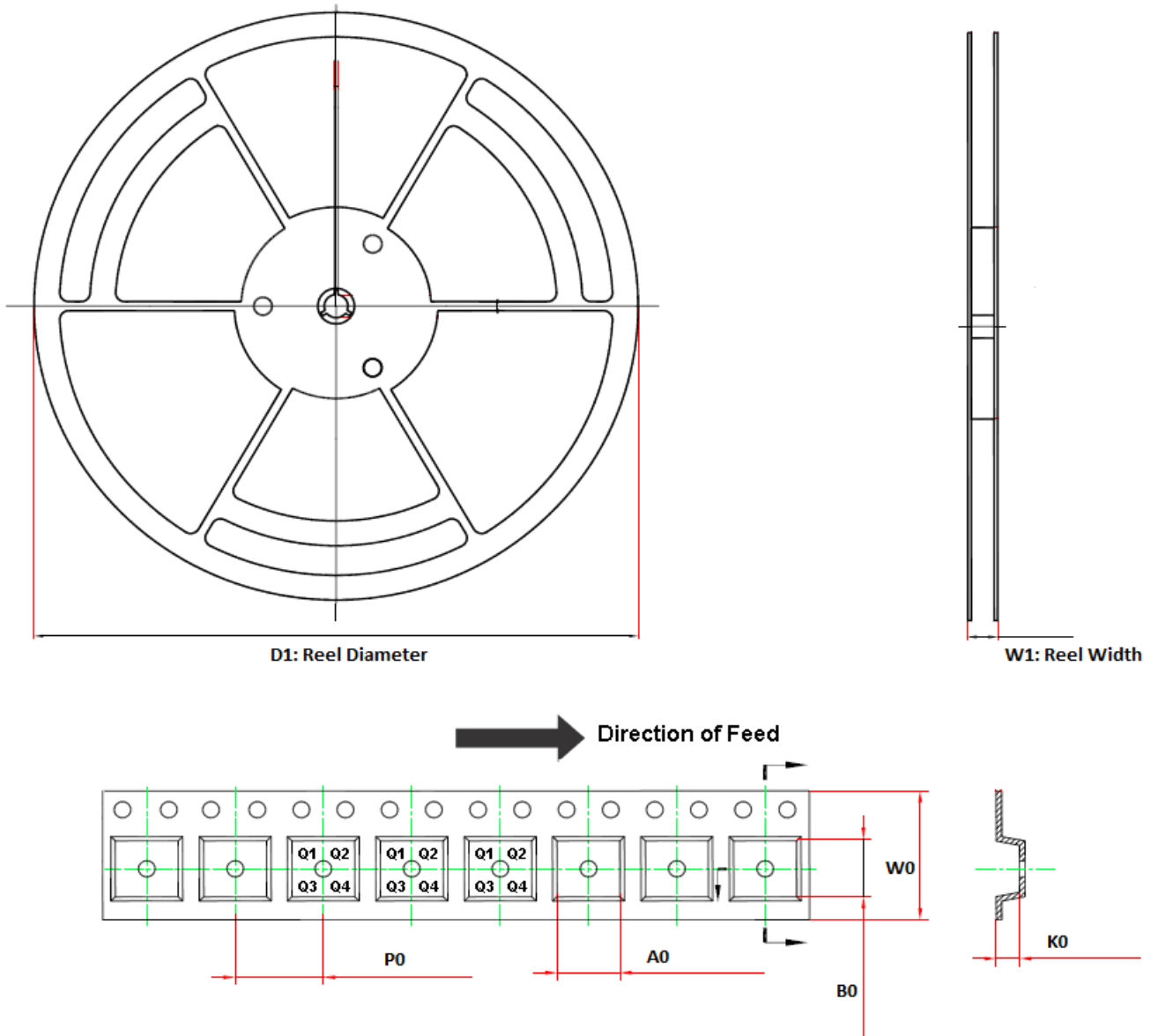

Order Number	Package	D1	W1	A0	B0	K0	P0	W0	Pin1 Quadrant
TP2311-TR	5-Pin SOT23	180.0	13.1	3.2	3.2	1.4	4.0	8.0	Q3
TP2311-SR	8-Pin SOIC	330.0	17.6	6.4	5.4	2.1	8.0	12.0	Q1
TP2312-SR	8-Pin SOIC	330.0	17.6	6.4	5.4	2.1	8.0	12.0	Q1
TP2312-VR	8-Pin MSOP	330.0	17.6	5.2	3.3	1.5	8.0	12.0	Q1
TP2314-SR	14-Pin SOIC	330.0	21.6	6.5	9.0	2.1	8.0	16.0	Q1
TP2314-TR	14-Pin TSSOP	330.0	17.6	6.8	5.4	1.2	8.0	12.0	Q1

Package Outline Dimensions

SOT23-5

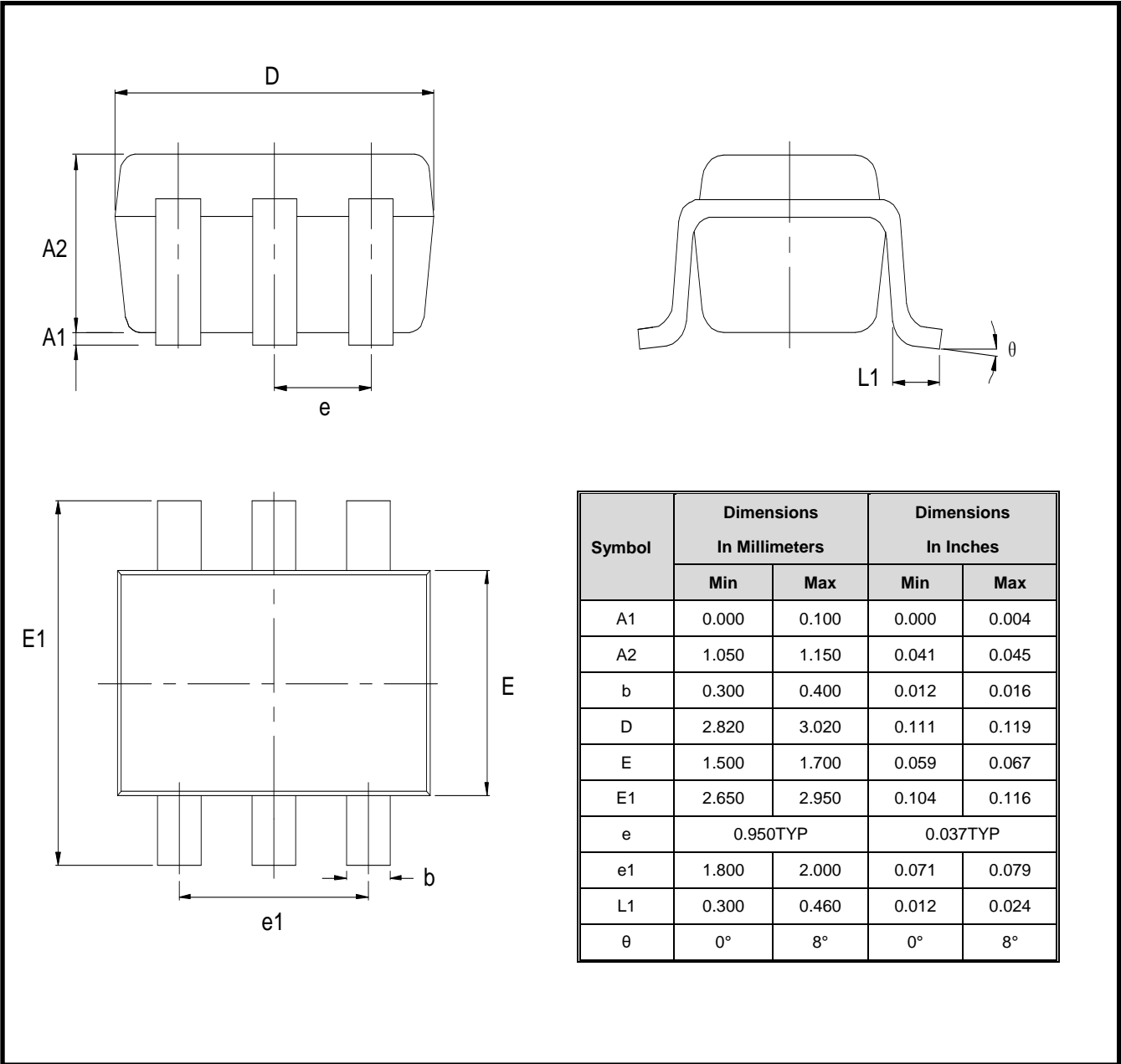

Symbol	Dimensions In Millimeters		Dimensions In Inches	
	Min	Max	Min	Max
A1	0.000	0.100	0.000	0.004
A2	1.050	1.150	0.041	0.045
b	0.300	0.400	0.012	0.016
D	2.820	3.020	0.111	0.119
E	1.500	1.700	0.059	0.067
E1	2.650	2.950	0.104	0.116
e	0.950TYP		0.037TYP	
e1	1.800	2.000	0.071	0.079
L1	0.300	0.460	0.012	0.024
theta	0°	8°	0°	8°

# TP2311 / TP2312 / TP2314

## 10MHz Bandwidth, Low Noise Precision Op-amps

### Package Outline Dimensions

SOT-23-8

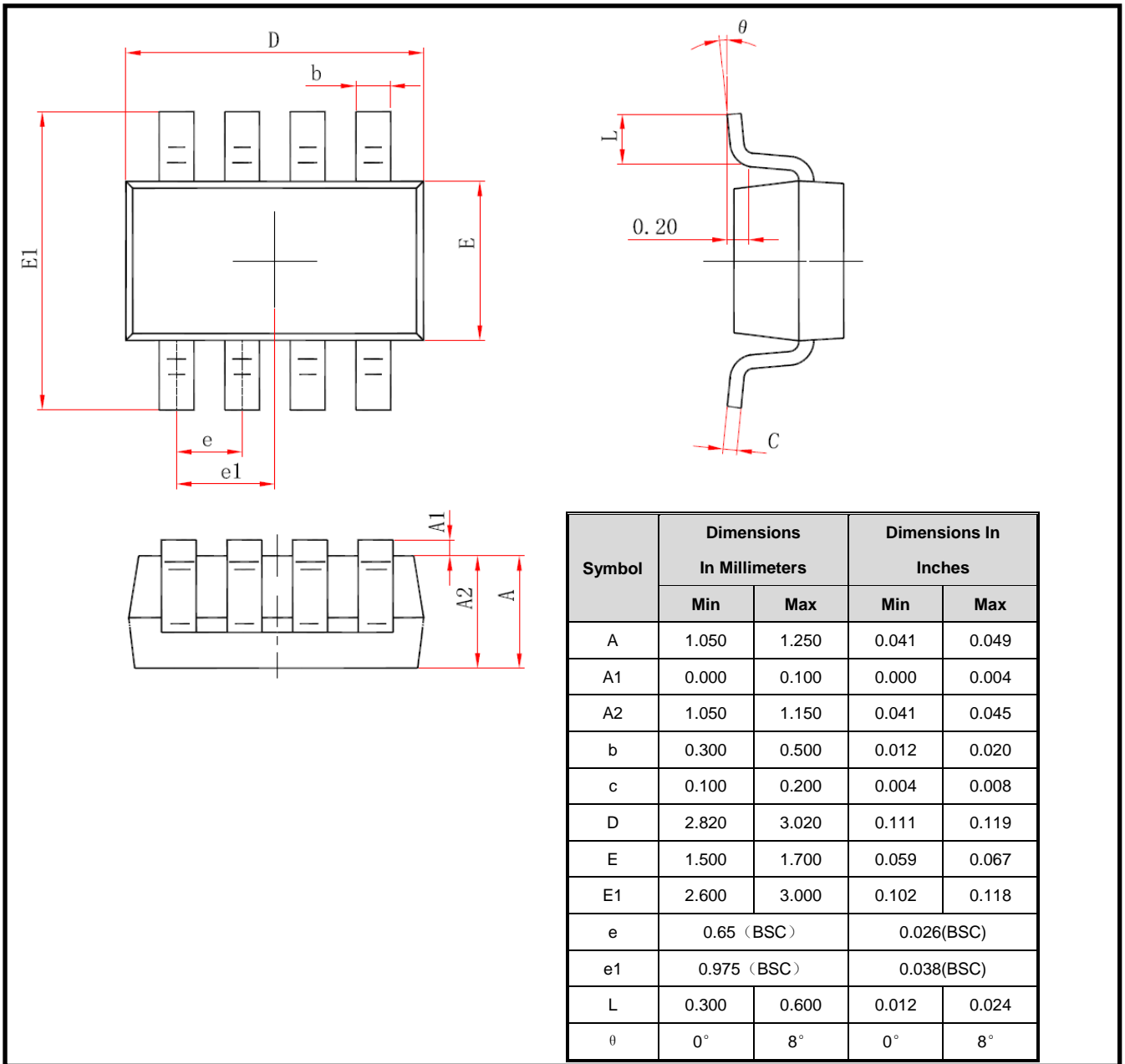



Package Outline Dimensions

SO-8 (SOIC-8)

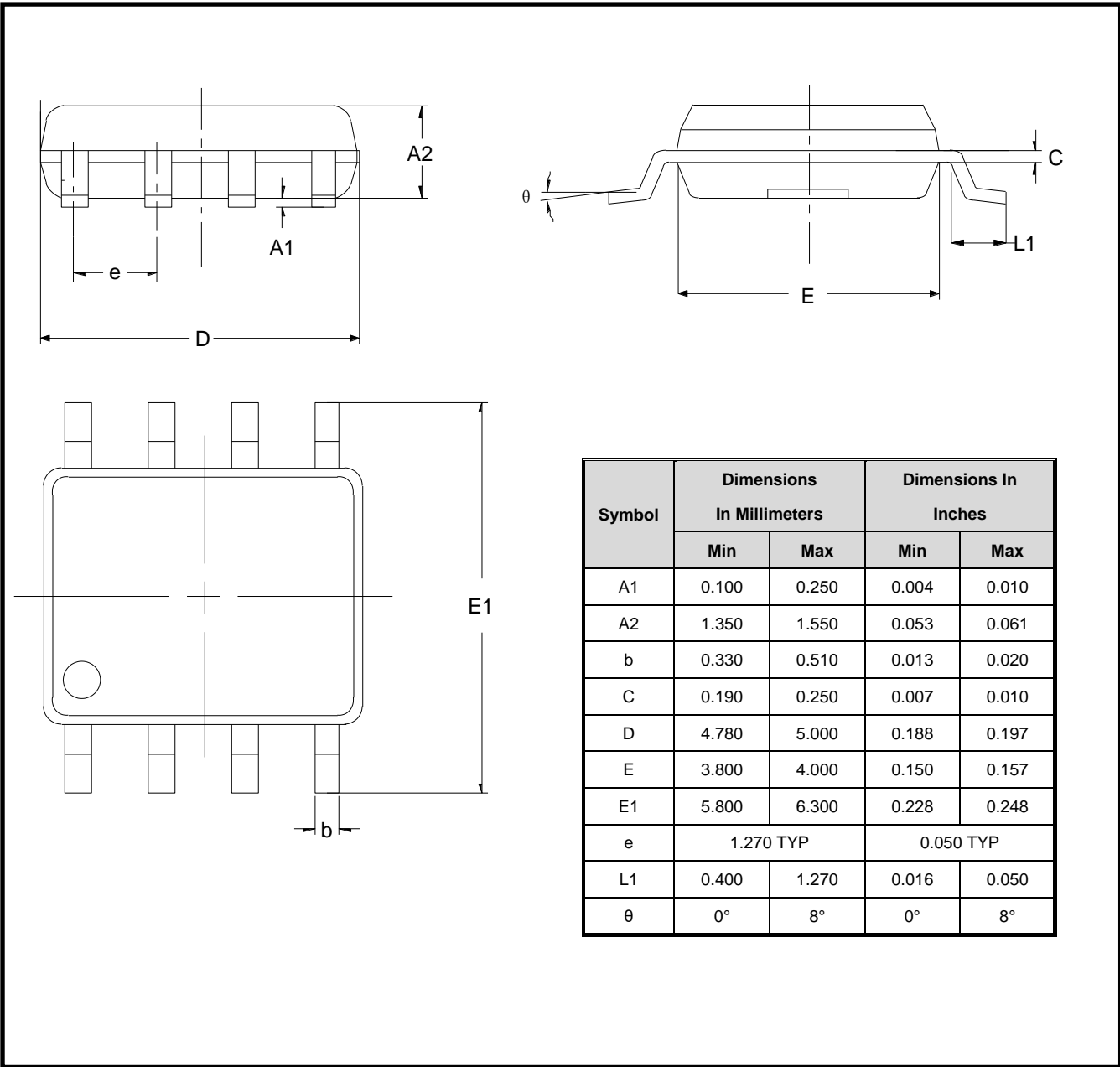

# TP2311 / TP2312 / TP2314

## 10MHz Bandwidth, Low Noise Precision Op-amps

### Package Outline Dimensions

MSOP-8

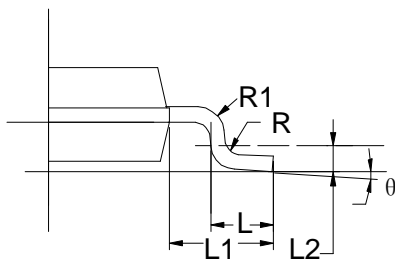
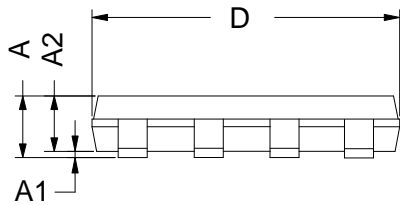
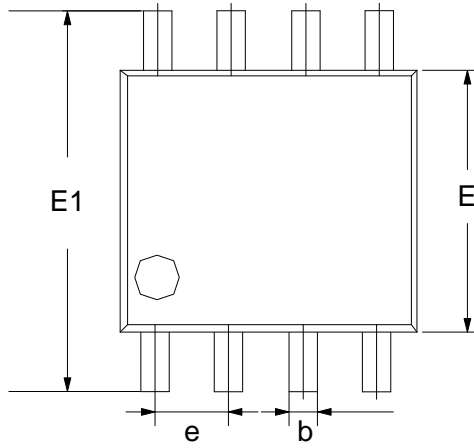

Symbol	Dimensions In Millimeters		Dimensions In Inches	
	Min	Max	Min	Max
A	0.800	1.200	0.031	0.047
A1	0.000	0.200	0.000	0.008
A2	0.760	0.970	0.030	0.038
b	0.30 TYP		0.012 TYP	
C	0.15 TYP		0.006 TYP	
D	2.900	3.100	0.114	0.122
e	0.65 TYP		0.026	
E	2.900	3.100	0.114	0.122
E1	4.700	5.100	0.185	0.201
L1	0.410	0.650	0.016	0.026
θ	0°	6°	0°	6°

Package Outline Dimensions

TSSOP-14

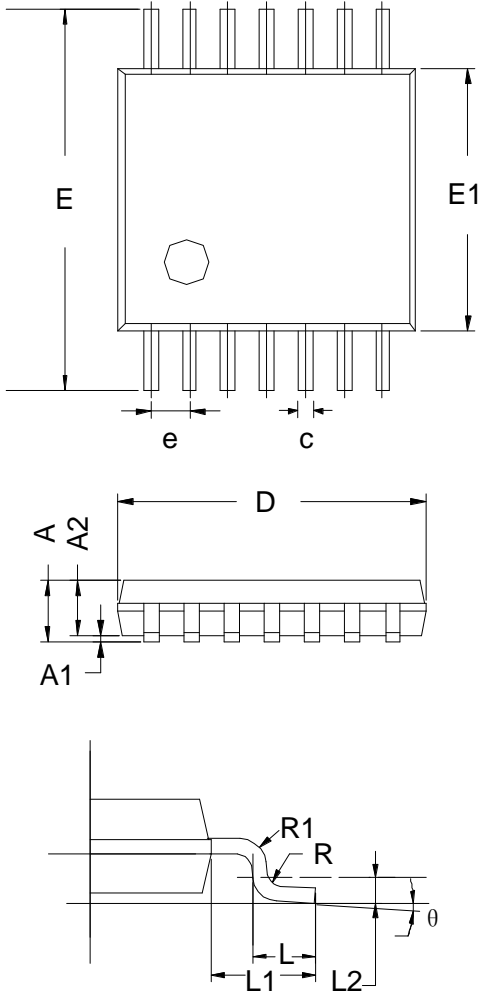

Symbol	Dimensions In Millimeters		
	MIN	TYP	MAX
A	-	-	1.20
A1	0.05	-	0.15
A2	0.90	1.00	1.05
b	0.20	-	0.28
c	0.10	-	0.19
D	4.86	4.96	5.06
E	6.20	6.40	6.60
E1	4.30	4.40	4.50
e	0.65 BSC		
L	0.45	0.60	0.75
L1	1.00 REF		
L2	0.25 BSC		
R	0.09	-	-
θ	0°	-	8°

# TP2311 / TP2312 / TP2314

## 10MHz Bandwidth, Low Noise Precision Op-amps

### Package Outline Dimensions

SO-14 (SOIC-14)

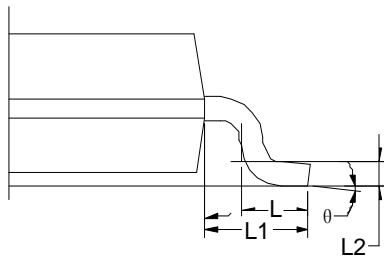
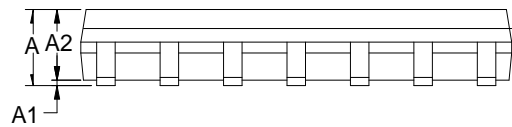
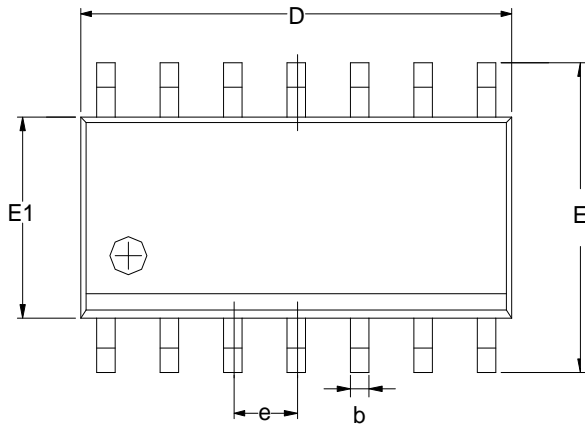

Symbol	Dimensions In Millimeters		
	MIN	TYP	MAX
A	1.35	1.60	1.75
A1	0.10	0.15	0.25
A2	1.25	1.45	1.65
b	0.36		0.49
D	8.53	8.63	8.73
E	5.80	6.00	6.20
E1	3.80	3.90	4.00
e	1.27 BSC		
L	0.45	0.60	0.80
L1	1.04 REF		
L2	0.25 BSC		
θ	0°		8°