



P-Channel Enhancement Mode Vertical DMOS FETs

Features

- ▶ Low threshold (-2.4V max.)
- ▶ High input impedance
- ▶ Low input capacitance (125pF max.)
- ▶ Fast switching speeds
- ▶ Low on-resistance
- ▶ Free from secondary breakdown
- ▶ Low input and output leakage

Applications

- ▶ Logic level interfaces - ideal for TTL and CMOS
- ▶ Solid state relays
- ▶ Battery operated systems
- ▶ Photo voltaic drives
- ▶ Analog switches
- ▶ General purpose line drivers
- ▶ Telecom switches

General Description

This low threshold enhancement-mode (normally-off) transistor utilizes a vertical DMOS structure and Supertex's well-proven silicon-gate manufacturing process. This combination produces a device with the power handling capabilities of bipolar transistors and with the high input impedance and positive temperature coefficient inherent in MOS devices. Characteristic of all MOS structures, this device is free from thermal runaway and thermally-induced secondary breakdown.

Supertex's vertical DMOS FETs are ideally suited to a wide range of switching and amplifying applications where very low threshold voltage, high breakdown voltage, high input impedance, low input capacitance, and fast switching speeds are desired.

Ordering Information

| Device | Package Options | | | BV _{DSS} /BV _{DGS} (V) | R _{DS(ON)} (max) (Ω) | V _{GS(th)} (max) (V) | I _{D(ON)} (min) (A) |
|--------|-----------------|-------------------|----------|---|-------------------------------------|-------------------------------------|------------------------------------|
| | TO-92 | TO-243AA (SOT-89) | Die* | | | | |
| TP2540 | TP2540N3-G | TP2540N8-G | TP2540ND | -400 | 25 | -2.4 | -0.4 |

-G indicates package is RoHS compliant ('Green')
* MIL visual screening available.



Absolute Maximum Ratings

| Parameter | Value |
|-----------------------------------|-------------------|
| Drain-to-source voltage | BV _{DSS} |
| Drain-to-gate voltage | BV _{DGS} |
| Gate-to-source voltage | ±20V |
| Operating and storage temperature | -55°C to +150°C |
| Soldering temperature* | +300°C |

Absolute Maximum Ratings are those values beyond which damage to the device may occur. Functional operation under these conditions is not implied. Continuous operation of the device at the absolute rating level may affect device reliability. All voltages are referenced to device ground.

* Distance of 1.6mm from case for 10 seconds.

Pin Configurations

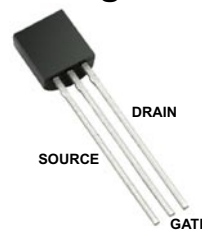

TO-92 (N3)

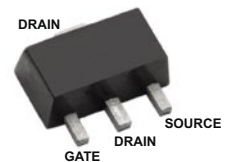

TO-243AA (SOT-89) (N8)

Product Marking

SiTP
2 5 4 0
YYWW

YY = Year Sealed
WW = Week Sealed
_____ = "Green" Packaging

Package may or may not include the following marks: Si or

TO-92 (N3)

TP5DW

W = Code for week sealed
_____ = "Green" Packaging

Package may or may not include the following marks: Si or

TO-243AA (SOT-89) (N8)

Thermal Characteristics

| Package | I_D (continuous) [†] (mA) | I_D (pulsed) (A) | Power Dissipation @ $T_A = 25^\circ\text{C}$ (W) | θ_{jc} $^\circ\text{C/W}$ | θ_{ja} $^\circ\text{C/W}$ | I_{DR} [‡] (mA) | I_{DRM} (A) |
|-------------------|--|--------------------------|--|-------------------------------------|-------------------------------------|-------------------------------|------------------|
| TO-92 | -86 | -0.6 | 0.74 | 125 | 170 | -86 | -0.6 |
| TO-243AA (SOT-89) | -125 | -1.2 | 1.6 [‡] | 15 | 78 [‡] | -125 | -1.2 |

[†] I_D (continuous) is limited by max rated T_j .
[‡] Mounted on FR5 board, 25mm x 25mm x 1.57mm.

Electrical Characteristics ($T_A = 25^\circ\text{C}$ unless otherwise specified)

| Sym | Parameter | Min | Typ | Max | Units | Conditions |
|---------------------|--|------|------|------|----------------------|---|
| BV_{DSS} | Drain-to-source breakdown voltage | -400 | - | - | V | $V_{GS} = 0V, I_D = -2.0mA$ |
| $V_{GS(th)}$ | Gate threshold voltage | -1.0 | - | -2.4 | V | $V_{GS} = V_{DS}, I_D = -1.0mA$ |
| $\Delta V_{GS(th)}$ | Change in $V_{GS(th)}$ with temperature | - | - | 4.8 | mV/ $^\circ\text{C}$ | $V_{GS} = V_{DS}, I_D = -1.0mA$ |
| I_{GSS} | Gate body leakage | - | - | -100 | nA | $V_{GS} = \pm 20V, V_{DS} = 0V$ |
| I_{DSS} | Zero gate voltage drain current | - | - | -10 | μA | $V_{GS} = 0V, V_{DS} = \text{Max Rating}$ |
| | | - | - | -1.0 | mA | $V_{DS} = 0.8 \text{ Max Rating}, V_{GS} = 0V, T_A = 125^\circ\text{C}$ |
| $I_{D(ON)}$ | On-state drain current | -0.2 | -0.3 | - | A | $V_{GS} = -4.5V, V_{DS} = -25V$ |
| | | -0.4 | -1.1 | - | | $V_{GS} = -10V, V_{DS} = -25V$ |
| $R_{DS(ON)}$ | Static drain-to-source on-state resistance | - | 20 | 30 | Ω | $V_{GS} = -4.5V, I_D = -100mA$ |
| | | - | 19 | 25 | | $V_{GS} = -10V, I_D = -100mA$ |
| $\Delta R_{DS(ON)}$ | Change in $R_{DS(ON)}$ with temperature | - | - | 0.75 | %/ $^\circ\text{C}$ | $V_{GS} = -10V, I_D = -100mA$ |
| G_{FS} | Forward transconductance | 100 | 175 | - | mmho | $V_{DS} = -25V, I_D = -100mA$ |
| C_{ISS} | Input capacitance | - | 60 | 125 | pF | $V_{GS} = 0V, V_{DS} = -25V, f = 1.0 \text{ MHz}$ |
| C_{OSS} | Common source output capacitance | - | 20 | 70 | | |
| C_{RSS} | Reverse transfer capacitance | - | 10 | 25 | | |
| $t_{d(ON)}$ | Turn-on delay time | - | - | 10 | ns | $V_{DD} = -25V, I_D = -0.4A, R_{GEN} = 25\Omega$ |
| t_r | Rise time | - | - | 10 | | |
| $t_{d(OFF)}$ | Turn-off delay time | - | - | 20 | | |
| t_f | Fall time | - | - | 13 | | |
| V_{SD} | Diode forward voltage drop | - | - | -1.8 | V | $V_{GS} = 0V, I_{SD} = -100mA$ |
| t_{rr} | Reverse recovery time | - | 300 | - | ns | $V_{GS} = 0V, I_{SD} = -100mA$ |

Notes:

- All D.C. parameters 100% tested at 25°C unless otherwise stated. (Pulse test: 300µs pulse, 2% duty cycle.)
- All A.C. parameters sample tested.

Switching Waveforms and Test Circuit

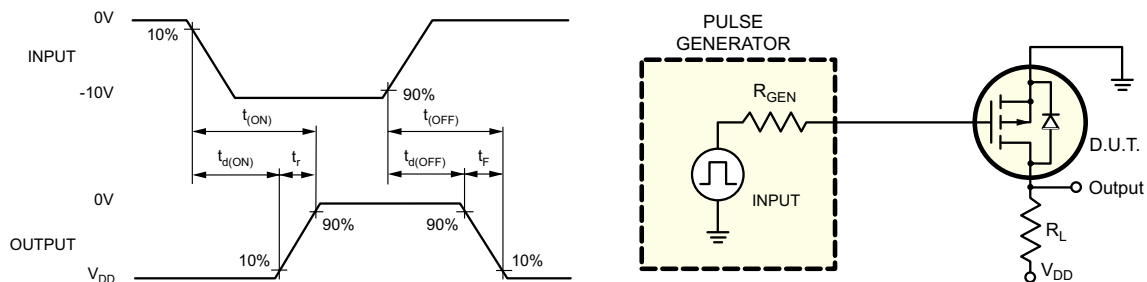

Typical Performance Curves

Output Characteristics

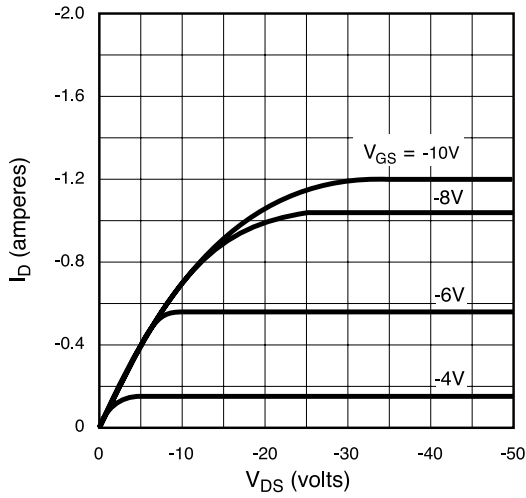

Saturation Characteristics

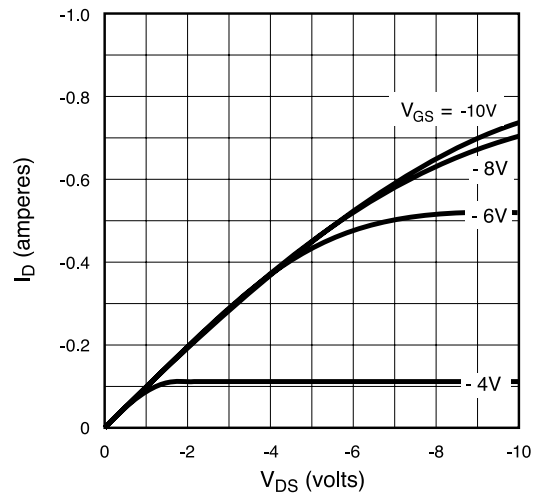

Transconductance vs. Drain Current

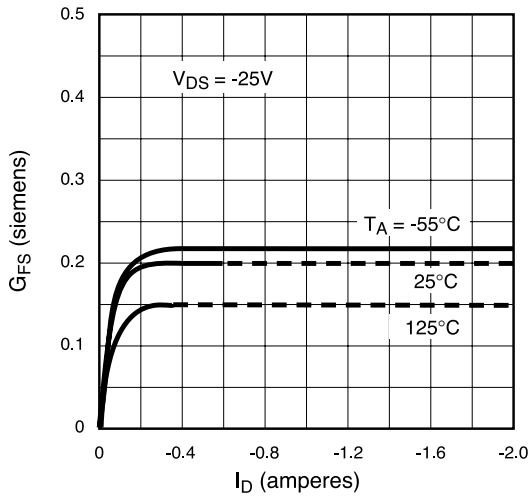

Power Dissipation vs. Ambient Temperature

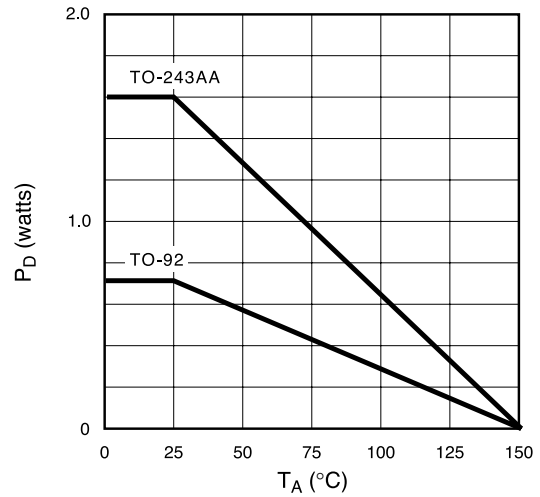

Maximum Rated Safe Operating Area

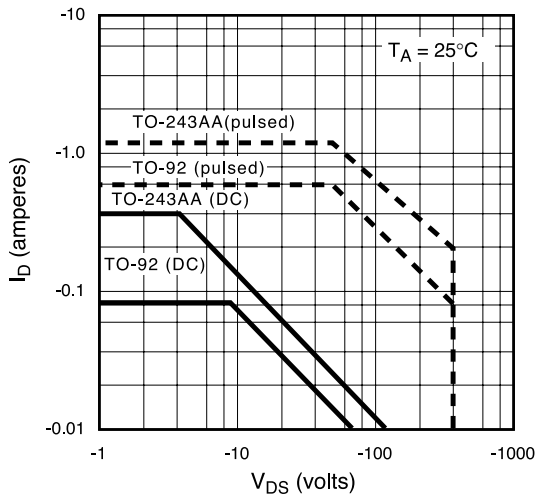

Thermal Response Characteristics

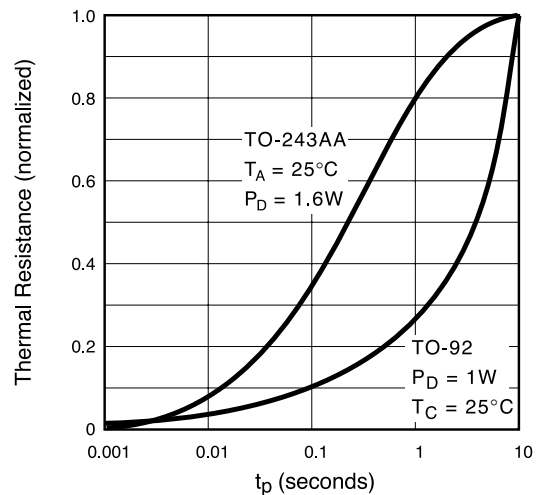

Typical Performance Curves (cont.)

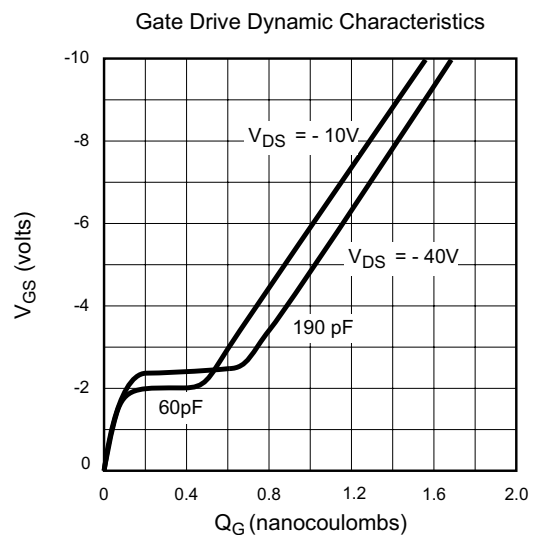
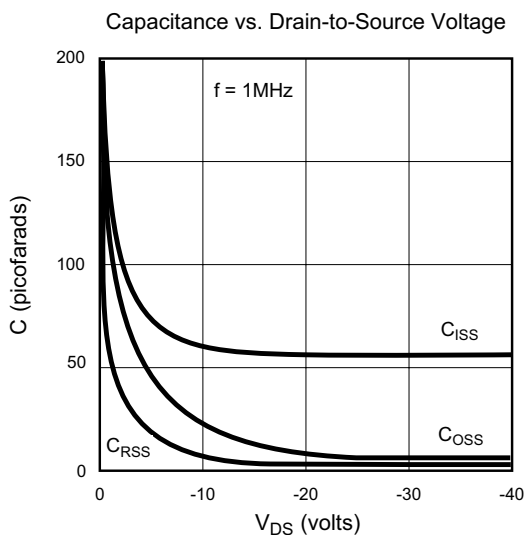
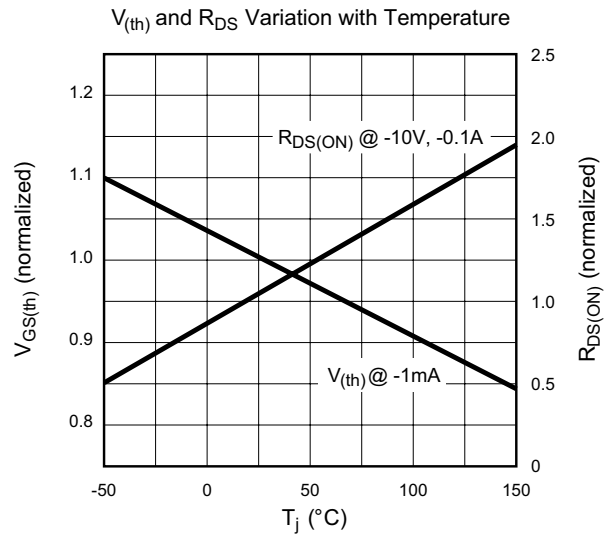
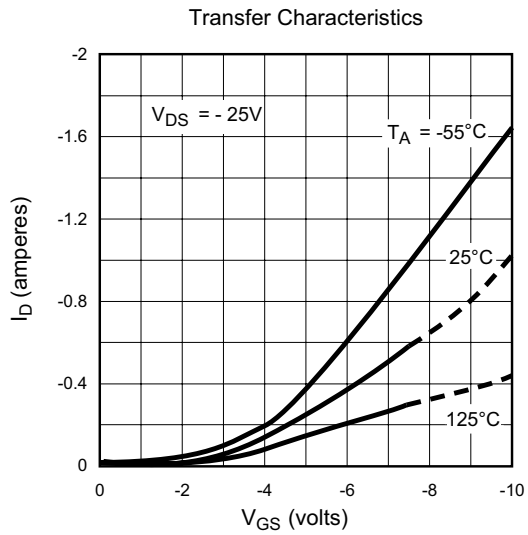
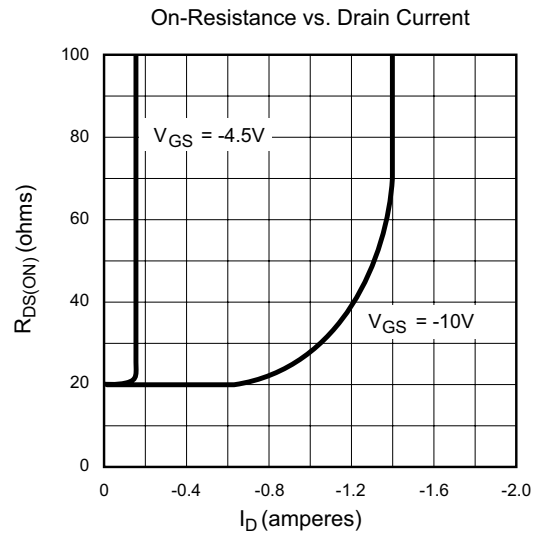
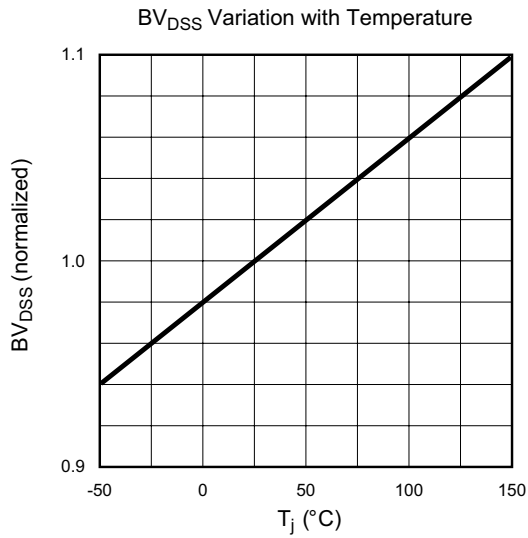

3-Lead TO-92 Package Outline (N3)

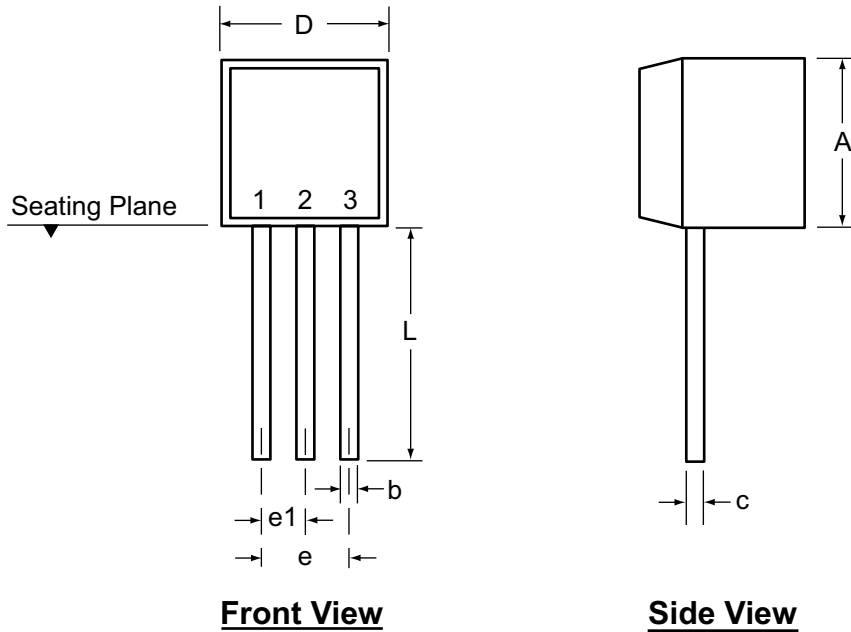

| Symbol | A | b | c | D | E | E1 | e | e1 | L | |
|------------------------|-----|------|-------------------|-------------------|------|------|------|------|------|-------|
| Dimensions (inches) | MIN | .170 | .014 [†] | .014 [†] | .175 | .125 | .080 | .095 | .045 | .500 |
| | NOM | - | - | - | - | - | - | - | - | - |
| | MAX | .210 | .022 [†] | .022 [†] | .205 | .165 | .105 | .105 | .055 | .610* |

JEDEC Registration TO-92.

* This dimension is not specified in the JEDEC drawing.

† This dimension differs from the JEDEC drawing.

Drawings not to scale.

Supertex Doc.#: DSPD-3TO92N3, Version E041009.

3-Lead TO-243AA (SOT-89) Package Outline (N8)

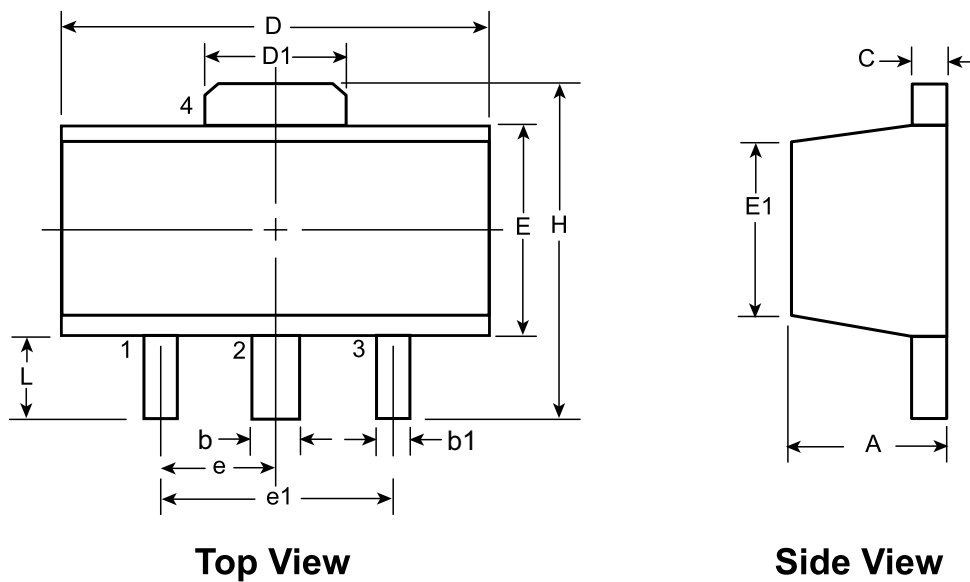

| Symbol | | A | b | b1 | C | D | D1 | E | E1 | e | e1 | H | L |
|-----------------|-----|------|------|------|------|------|------|------|-------|----------|----------|------|------|
| Dimensions (mm) | MIN | 1.40 | 0.44 | 0.36 | 0.35 | 4.40 | 1.62 | 2.29 | 2.00† | 1.50 BSC | 3.00 BSC | 3.94 | 0.89 |
| | NOM | - | - | - | - | - | - | - | - | | | - | - |
| | MAX | 1.60 | 0.56 | 0.48 | 0.44 | 4.60 | 1.83 | 2.60 | 2.29 | | | 4.25 | 1.20 |

JEDEC Registration TO-243, Variation AA, Issue C, July 1986.

† This dimension differs from the JEDEC drawing

Drawings not to scale.

Supertex Doc. #: DSPD-3TO243AAN8, Version E051509.

(The package drawing(s) in this data sheet may not reflect the most current specifications. For the latest package outline information go to <http://www.supertex.com/packaging.html>.)

Supertex inc. does not recommend the use of its products in life support applications, and will not knowingly sell them for use in such applications unless it receives an adequate "product liability indemnification insurance agreement." Supertex inc. does not assume responsibility for use of devices described, and limits its liability to the replacement of the devices determined defective due to workmanship. No responsibility is assumed for possible omissions and inaccuracies. Circuitry and specifications are subject to change without notice. For the latest product specifications refer to the Supertex inc. website: <http://www.supertex.com>.