

DESCRIPTION: Wide Input Non-Isolated & Regulated Single Output

TP78XX-2 series switching regulators are ideal replacement for TP78xx linear regulators and LDOs. The efficiency of up to 92% means that very little energy is wasted as heat so there is no need for any heat sinks with their additional space and mounting costs. They are widely used in industrial control, instrumentation, and electric power applications.

FEATURES

ROHS Compliant	Wide input non-isolated, regulated single output	Efficiency up to 93%
Short circuit protection, Thermal shutdown	Temperature range: -40°C ~ +85°C	Low ripple noise
SIP package	No heat sink required	Industry standard pinout

SELECTION GUIDE

Part Number	Input Voltage (VDC)		Output		Efficiency (%)	
	Nominal	Range	Voltage (VDC)	Current (mA)	Vin (Min)	Vin(Max)
TP781.5-2	12	4.75~18	1.5	2000	79	76
TP781.8-2	12	4.75~18	1.8	2000	81	79
TP782.5-2	12	4.75~18	2.5	2000	85	83
TP783.3-2	12	4.75~18	3.3	2000	87	86
TP785.0-2	12	7-18	5.0	2000	91	88
TP786.5-2	12	8.5-18	6.5	2000	92	91

The above part number with "L" Suffix are 90° bent pins power converters, for example TP78L1.5-2L.

OUTPUT CHARACTERISTICS

Parameter	Conditions	Min	Typ.	Max.	Units
Output voltage accuracy	100% full load, input voltage range		±2	±3	
Line regulation	Vin=min. to max, at full load		±0.5	±0.75	%
Load regulation	10% to 100% load		±0.5	±1.0	
Ripple & Noise	20MHz bandwidth,(refer to figure 3)		25	45	mvp-p
Short circuit protection			Continuous, auto-recovery		
Thermal shutdown	Internal IC junction		150		°C
Output current limit			5000		mA
Switching frequency	Full load, input voltage range	300	340	380	KHz
Dynamic load stability				±100	mA
Quiescent current	Vin from min to max and at 0% load		5	10	mA
Temperature coefficient	-40°C~+85°C			±0.03	%/°C
Max capacitance load				1000	µF

All specifications typical at TA=25°C, nominal input voltage and rated output current unless otherwise specified.

COMMON SPECIFICATIONS

Parameter	Conditions	Min.	Typ.	Max.	Units
Storage humidity range				95	
Operating temp. range	Power derating (above 71°C)	-40		85	
Storage temp. range		-55		125	°C
Storage temp. Range Temp rise at full load				100	
Lead temperature	1.5mm from case for 10 seconds			300	
Cooling		Free air convection			
Case material		Plastic (UL94-V0)			
MTBF	25°C (MIL-HDBK-217F)	2000			k hours
Weight			4.0		g

TEMPERATURE DERATING GRAPHS

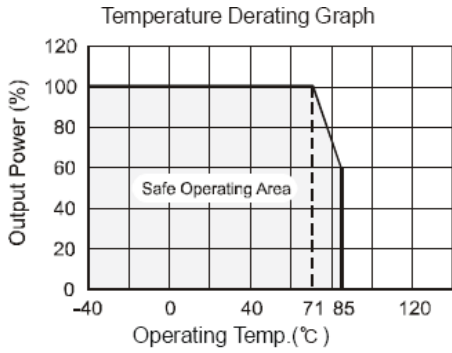

EXTERNAL CAPACITOR TABLE

Part Number	C1(Ceramic Capacitor)	C2(Ceramic Capacitor)
TP781.5-2	10 μ F/25V	22 μ F/6.3V
TP781.8-2	10 μ F/25V	22 μ F/6.3V
TP782.5-2	10 μ F/25V	22 μ F/6.3V
TP783.3-2	10 μ F/25V	22 μ F/6.3V
TP785.0-2	10 μ F/25V	22 μ F/16V
TP786.5-2	10 μ F/25V	22 μ F/16V

STANDARD APPLICATION CIRCUIT

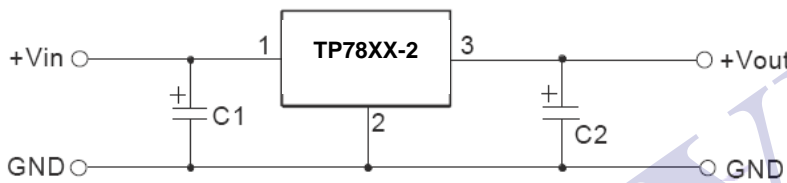

- Note:
1. C1 and C2 are required and should be fitted close to the converter pins.
 2. The capacitance of C1,C2 sees external capacitor table, it can be increased properly if required, and tantalum or low ESR electrolytic capacitors may also suffice.
 3. No parallel connection or plug and play.

TEST CONFIGURATIONS (TA=25°C)

1. Efficiency and Output Voltage Ripple Test

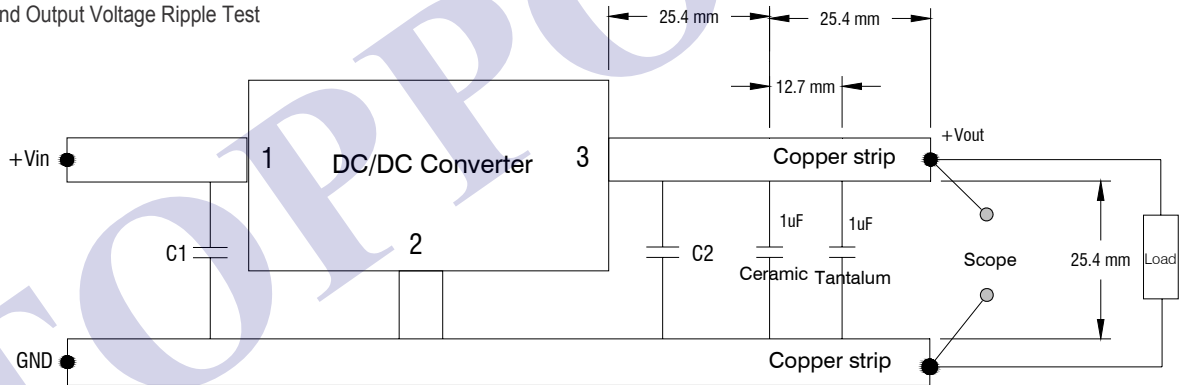

2. Start-up and Load Transient Response Test

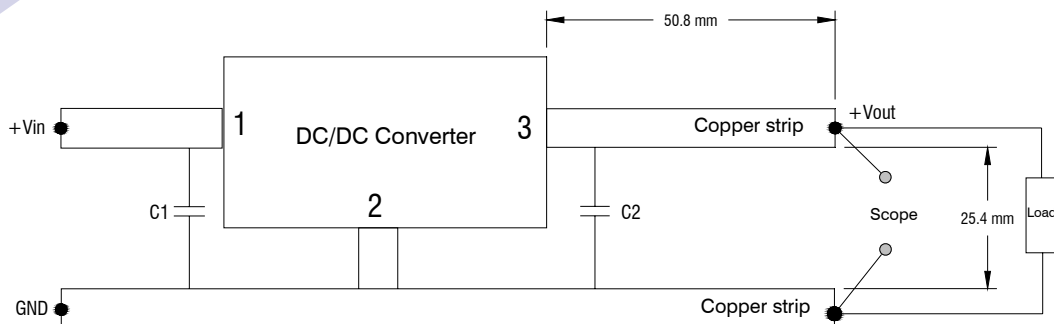

MECHANICAL DIMENSIONS

SIP Package

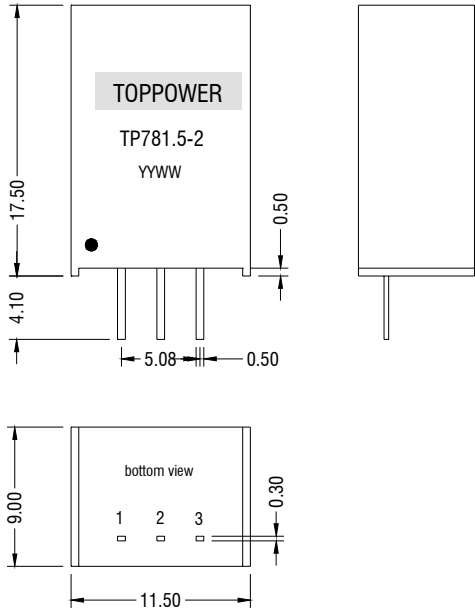

All dimensions in mm ±0.25. All pins on a 2.54mm pitch.

90° bent pins power converters(part number with "L" Suffix)

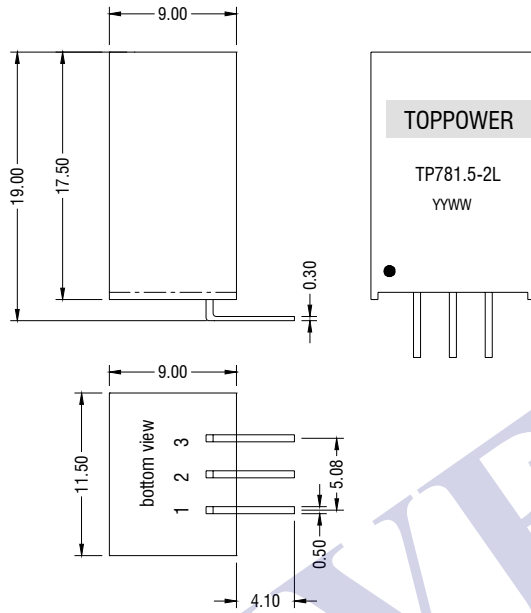

PIN CONNECTIONS

Pin	Function
1	+Vin
2	GND
3	+Vout

RECOMMENDED FOOTPRINT DETAILS

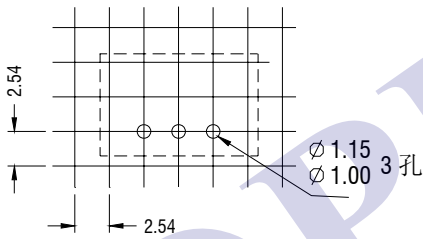

Unless otherwise stated all dimensions in mm ±0.5mm.

90° bent pins power converters(part number with "L" Suffix)

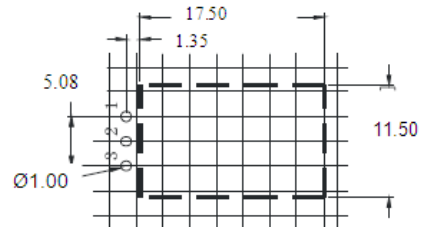

Unless otherwise stated all dimensions in mm ±0.5mm.

TUBE OUTLINE DIMENSIONS

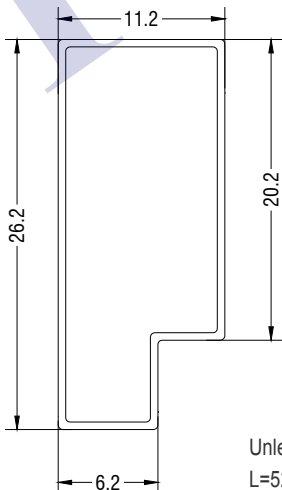

Unless otherwise stated all dimensions in mm ±0.5mm.
 L=520mm ±2mm Packaging quantity:44PCS
 L=220mm ±2mm Packaging quantity:17PCS

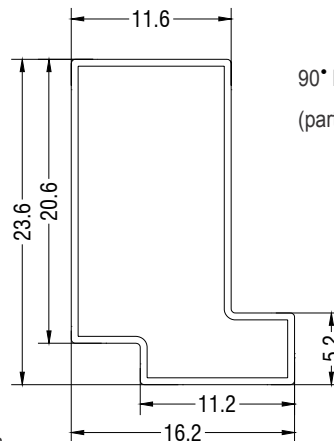

90° bent pins power converters
(part number with "L" Suffix)