

## Features

- Supply Voltage: 1.75 V to 5.5 V
- Offset Voltage:  $\pm 1.5$  mV Maximum
- GPWP: 300 kHz, Slew Rate: 0.15 V/ $\mu$ s
- Rail-to-Rail Input and Output
- 0.1-Hz to 10-Hz Voltage Noise: 1  $\mu$ V<sub>PP</sub>
- No Significant Output Glitch when Power on and off
- Low Power: 25  $\mu$ A Maximum per Channel
- $-40^{\circ}\text{C}$  to  $125^{\circ}\text{C}$  Operation Temperature Range

## Applications

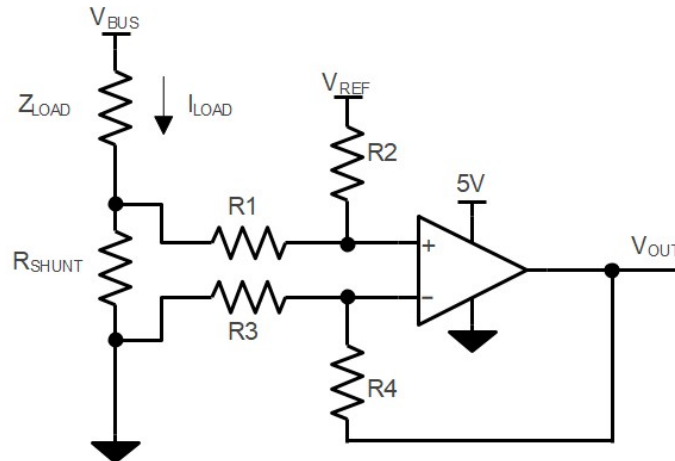
- Sensor Signal Conditioning
- Instrumentation
- Industrial Control
- IoT Device

## Description

The TPA653x series op-amps are CMOS single, dual, and quad RRIO op-amps with low offset, low power, and stable high-frequency response. They incorporate 3PEAK's proprietary and patented design techniques to achieve 300-kHz bandwidth, 0.15-V/ $\mu$ s slew rate, and low distortion while drawing only 25  $\mu$ A of quiescent current per amplifier which is suitable for low-power applications.

The TPA653x series op-amps have 1- $\mu$ V<sub>PP</sub> voltage noise at 0.1 Hz to 10 Hz, because the bipolar transistor with low 1/f noise is used as the input stage.

## Typical Application Circuit



$$V_{OUT} = (I_{LOAD} \times R_{SHUNT}) \times (R_2 / R_1) + V_{REF}$$

$$\text{When } R_3 = R_1, R_2 = R_4, R_{SHUNT} \ll R_1$$

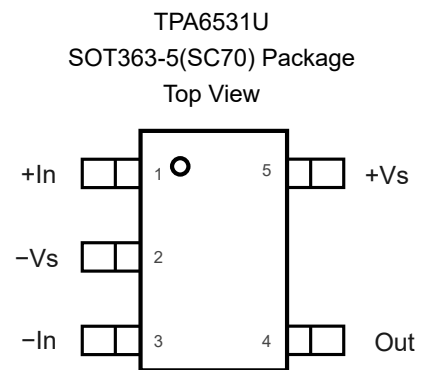
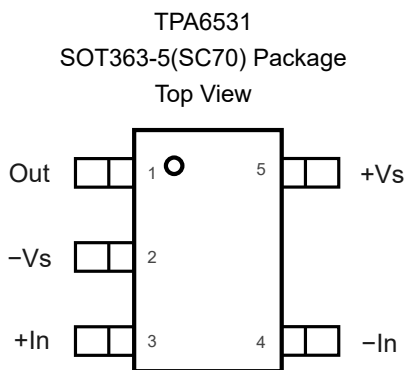
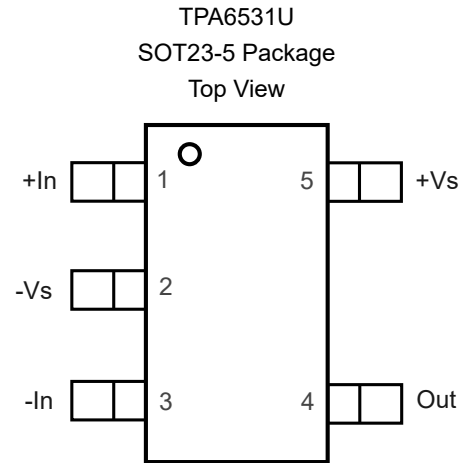
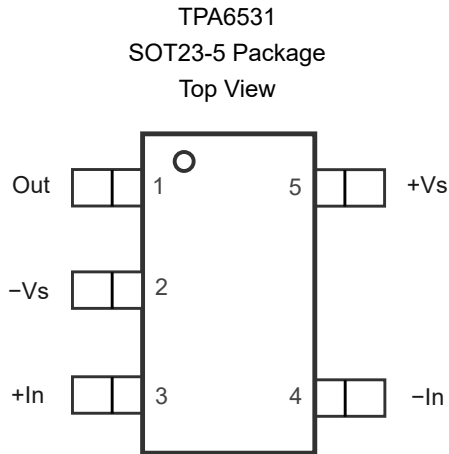
## Table of Contents

<b>Features</b> .....	1
<b>Applications</b> .....	1
<b>Description</b> .....	1
<b>Typical Application Circuit</b> .....	1
<b>Revision History</b> .....	3
<b>Pin Configuration and Functions</b> .....	4
<b>Specifications</b> .....	8
Absolute Maximum Ratings <sup>(1)</sup> .....	8
ESD, Electrostatic Discharge Protection.....	8
Recommended Operating Conditions.....	8
Thermal Information.....	8
Electrical Characteristics.....	10
Typical Performance Characteristics.....	12
<b>Detailed Description</b> .....	17
Overview.....	17
Functional Block Diagram.....	17
Feature Description.....	17
<b>Application and Implementation</b> .....	19
Application Information .....	19
<b>Tape and Reel Information</b> .....	20
<b>Package Outline Dimensions</b> .....	22
SOT353-5.....	22
SOT363-6.....	23
SOT23-5.....	24
SOT23-6.....	25
SOP8.....	26
MSOP8.....	27
TSSOP14.....	28
SOP14.....	29
<b>Order Information</b> .....	30
<b>IMPORTANT NOTICE AND DISCLAIMER</b> .....	31

## Revision History

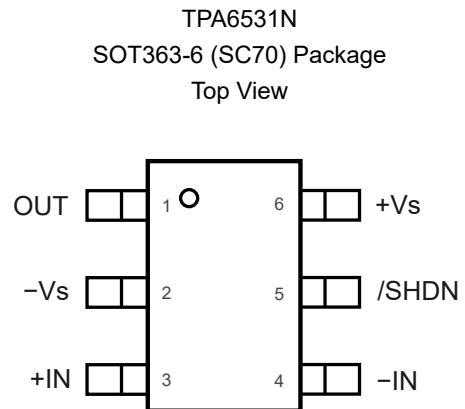
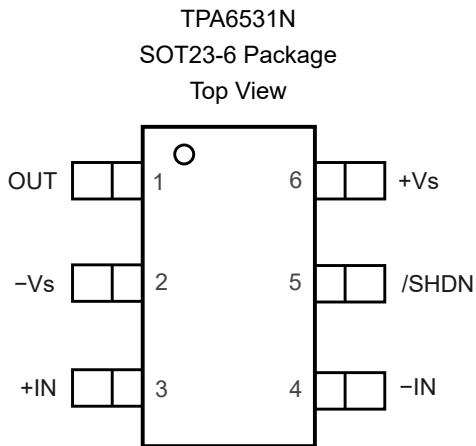
Date	Revision	Notes
2022-08-15	Rev.A.0	Initial version.
2023-02-25	Rev.A.1	Updated the minimum supply voltage to 1.75V.

## Pin Configuration and Functions

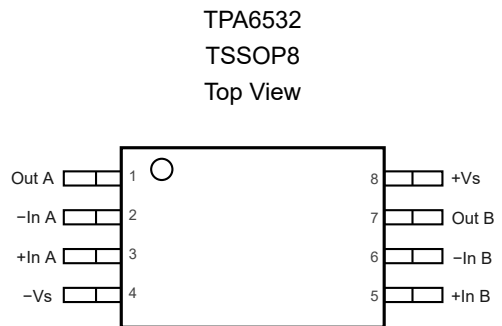
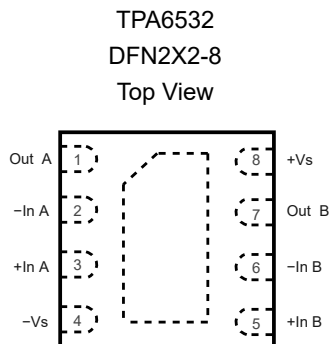
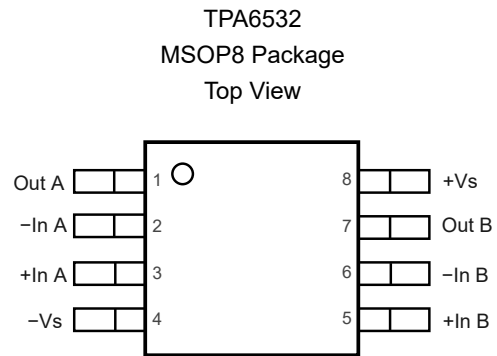
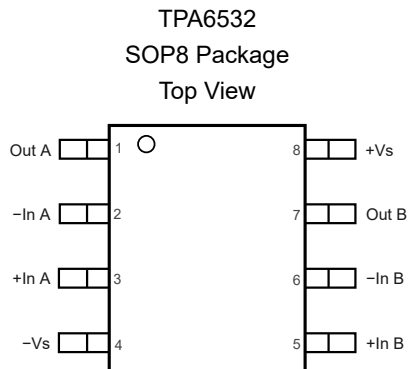


**Table 1. Pin Functions: TPA6531, TPA6531U**

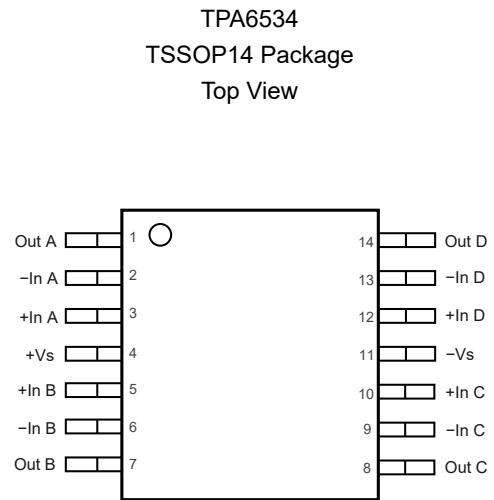
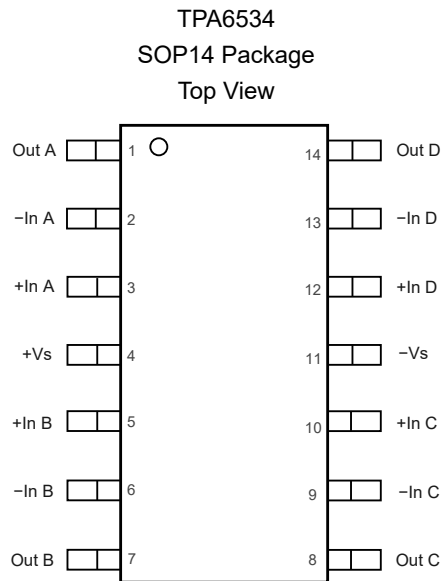
Pin No.		Name	I/O	Description
TPA6531	TPA6531U			
1	4	Out	Output	Output
2	2	-Vs		Negative power supply
3	1	+In	Input	Noninverting input
4	3	-In	Input	Inverting input
5	5	+Vs		Positive power supply


**Table 2. Pin Functions: TPA6531N**

Pin No.	Name	I/O	Description
1	Out	Output	Output
2	-Vs		Negative power supply
3	+In	Input	Noninverting input
4	-In	Input	Inverting input
5	/SHDN	Input	Shut down input, the device is shut down when the low-level input voltage is on the input; the device is active when the high-level input voltage is on the input. The device is active in default with a 10-M $\Omega$ internal pull-up resistor.
6	+Vs		Positive power supply


**Table 3. Pin Functions: TPA6532**

Pin No.	Name	I/O	Description
1	Out A	Output	Output
2	-In A	Input	Inverting input
3	+In A	Input	Noninverting input
4	-Vs		Negative power supply
5	+In B	Input	Noninverting input
6	-In B	Input	Inverting input
7	Out B	Output	Output
8	+Vs		Positive power supply



**Table 4. Pin Functions: TPA6534**

Pin No.	Name	I/O	Description
1	Out A	Output	Output
2	-In A	Input	Inverting input
3	+In A	Input	Noninverting input
4	+Vs		Positive power supply
5	+In B	Input	Noninverting input
6	-In B	Input	Inverting input
7	Out B	Output	Output power supply
8	Out C	Output	Output power supply
9	-In C	Input	Inverting input
10	+In C	Input	Noninverting input
11	-Vs		Negative power supply
12	+In D	Input	Noninverting input
13	-In D	Input	Inverting input
14	Out D	Output	Output

## Specifications

### Absolute Maximum Ratings <sup>(1)</sup>

Parameter		Min	Max	Unit
	Supply Voltage, (+V <sub>S</sub> ) – (–V <sub>S</sub> )		6.5	V
	Input Voltage	(–V <sub>S</sub> ) – 0.3	(+V <sub>S</sub> ) + 0.3	V
	Differential Input Voltage	(–V <sub>S</sub> ) – (+V <sub>S</sub> )	(+V <sub>S</sub> ) – (–V <sub>S</sub> )	V
	Input Current: +IN, –IN <sup>(2)</sup>	–10	+10	mA
	Output Voltage	(–V <sub>S</sub> ) – 0.3	(+V <sub>S</sub> ) + 0.3	V
	Output Short-Circuit Duration <sup>(3)</sup>		Infinite	
T <sub>J</sub>	Maximum Operating Junction Temperature		150	°C
T <sub>A</sub>	Operating Temperature Range	–40	125	°C
T <sub>STG</sub>	Storage Temperature Range	–65	150	°C
T <sub>L</sub>	Lead Temperature (Soldering 10 sec)		260	°C

(1) Stresses beyond those listed under Absolute Maximum Ratings may cause permanent damage to the device. Exposure to any Absolute Maximum Rating condition for extended periods may affect device reliability and lifetime.

(2) The inputs are protected by ESD protection diodes to each power supply. If the input extends more than 300 mV beyond the power supply, the input current should be limited to less than 10 mA.

(3) A heat sink may be required to keep the junction temperature below the absolute maximum. This depends on the power supply voltage and how many amplifiers are shorted. Thermal resistance varies with the amount of PC board metal connected to the package. The specified values are for short traces connected to the leads.

### ESD, Electrostatic Discharge Protection

Parameter		Condition	Minimum Level	Unit
HBM	Human Body Model ESD	ANSI/ESDA/JEDEC JS-001 <sup>(1)</sup>	2	kV
CDM	Charged Device Model ESD	ANSI/ESDA/JEDEC JS-002 <sup>(2)</sup>	1	kV

(1) JEDEC document JEP155 states that 500-V HBM allows safe manufacturing with a standard ESD control process.

(2) JEDEC document JEP157 states that 250-V CDM allows safe manufacturing with a standard ESD control process.

### Recommended Operating Conditions

Parameter		Min	Typ	Max	Unit
V <sub>S</sub>	Supply Voltage, (+V <sub>S</sub> ) – (–V <sub>S</sub> )	1.75		5.5	V
T <sub>A</sub>	Operating Temperature Range	–40		125	°C

### Thermal Information

Package Type	θ <sub>JA</sub>	θ <sub>Jc</sub>	Unit
SOT353-5 (SC70)	400	150	°C/W
SOT23-5	250	81	°C/W



Package Type	$\theta_{JA}$	$\theta_{JC}$	Unit
SOT23-6	250	81	°C/W
SOP8	158	43	°C/W
MSOP8	210	45	°C/W
TSSOP8	191	44	°C/W
SOP14	120	36	°C/W
TSSOP14	180	35	°C/W

## Electrical Characteristics

All test conditions:  $V_S = 5\text{ V}$ ,  $T_A = 25^\circ\text{C}$ ,  $R_L = 10\text{ k}\Omega$ ,  $C_L = 100\text{ pF}$ , unless otherwise noted.

Parameter	Conditions	$T_A$	Min	Typ	Max	Unit	
<b>Power Supply</b>							
$V_S$	Supply Voltage Range		1.75		5.5	V	
$I_Q$	Quiescent Current per Amplifier	$V_S = 1.75\text{ V to }5.5\text{ V}$ , TPA6531	$-40^\circ\text{C to }125^\circ\text{C}$	20	30	$\mu\text{A}$	
					35	$\mu\text{A}$	
		$V_S = 1.75\text{ V to }5.5\text{ V}$ , TPA6532/ TPA6534	$-40^\circ\text{C to }125^\circ\text{C}$	12	25	$\mu\text{A}$	
					30	$\mu\text{A}$	
PSRR	Power Supply Rejection Ratio	$V_S = 1.9\text{ V to }5.5\text{ V}$		90	110	dB	
			$-40^\circ\text{C to }125^\circ\text{C}$	85		dB	
	Power On Time			30		$\mu\text{s}$	
<b>Shutdown, TPA6531N only</b>							
	Quiescent Current in Shutdown Mode			0.5		$\mu\text{A}$	
			$-40^\circ\text{C to }125^\circ\text{C}$			$\mu\text{A}$	
	Input Low Voltage	Shutdown			$0.15 \cdot V_S$	V	
	Input High Voltage	Active		$0.85 \cdot V_S$		V	
	Input Current		$-40^\circ\text{C to }125^\circ\text{C}$	0.5	2	$\mu\text{A}$	
	Turn on time			30		$\mu\text{s}$	
	Turn off time			10		$\mu\text{s}$	
<b>Input Characteristics</b>							
$V_{OS}$	Input Offset Voltage	$V_{CM} = 0\text{ V to }5\text{ V}$		-1.5	0.1	1.5	mV
			$-40^\circ\text{C to }125^\circ\text{C}$	-3		3	mV
		$V_S = 1.75\text{ V}$ , $V_{CM} = 0.875\text{ V}$		-3	0.5	3	mV
$V_{OSTC}$	Input Offset Voltage Drift		$-40^\circ\text{C to }125^\circ\text{C}$	1		$\mu\text{V}/^\circ\text{C}$	
$I_B$	Input Bias Current	$V_{CM} = 0\text{ V}$		25		nA	
			$-40^\circ\text{C to }125^\circ\text{C}$	50		nA	
$I_{OS}$	Input Offset Current	$V_{CM} = 0\text{ V}$		1		nA	
$I_B$	Input Bias Current	$V_{CM} = 5\text{ V}$		10		nA	
			$-40^\circ\text{C to }125^\circ\text{C}$	30		nA	
$I_B$	Input Offset Current	$V_{CM} = 5\text{ V}$		1		nA	
$C_{IN}$	Input Capacitance	Differential Mode		2		pF	
		Common Mode		4		pF	
$A_v$	Open-loop Voltage Gain	$V_O = 0.1\text{ V to }4.9\text{ V}$ , $R_L = 100\text{ k}\Omega$		80	90	dB	
			$-40^\circ\text{C to }125^\circ\text{C}$	70		dB	

Parameter		Conditions	T <sub>A</sub>	Min	Typ	Max	Unit
V <sub>CMR</sub>	Common-mode Input Voltage Range		-40°C to 125°C	(-V <sub>S</sub> )		(+V <sub>S</sub> )	V
CMRR	Common Mode Rejection Ratio	V <sub>CM</sub> = 0 V to 3.5 V		80	95		dB
			-40°C to 125°C	75			dB
		V <sub>CM</sub> = 0 V to 5 V		70	85		dB
			-40°C to 125°C	65			dB
<b>Output Characteristics</b>							
	Output Voltage Swing from Positive Rail	V <sub>S</sub> = 5.5 V, R <sub>L</sub> = 10 kΩ to V <sub>S</sub> /2			3	10	mV
			-40°C to 125°C			15	mV
		V <sub>S</sub> = 5.5 V, R <sub>L</sub> = 2 kΩ to V <sub>S</sub> /2			10	30	mV
			-40°C to 125°C			40	mV
	Output Voltage Swing from Negative Rail	V <sub>S</sub> = 5.5 V, R <sub>L</sub> = 10 kΩ to V <sub>S</sub> /2			3	10	mV
			-40°C to 125°C			15	mV
		V <sub>S</sub> = 5.5 V, R <sub>L</sub> = 2 kΩ to V <sub>S</sub> /2			8	15	mV
			-40°C to 125°C			20	mV
I <sub>SC</sub>	Output Short-Circuit Current	V <sub>S</sub> = 5.5 V, Source		80	90		mA
			-40°C to 125°C	50			mA
		V <sub>S</sub> = 5.5 V, Sink		190	240		mA
			-40°C to 125°C	140			mA
<b>AC Specifications</b>							
GBW	Gain-Bandwidth Product				300		kHz
SR	Slew Rate	G = 1, 2 V step			0.15		V/μs
t <sub>OR</sub>	Overload Recovery				20		μs
t <sub>S</sub>	Settling Time, 0.1%	G = 1, 2 V step			10		μs
	Settling Time, 0.01%				12		μs
PM	Phase Margin	R <sub>L</sub> = 10 K, C <sub>L</sub> = 100 pF			60		°
GM	Gain Margin	R <sub>L</sub> = 10 K, C <sub>L</sub> = 100 pF			15		dB
	Channel Separation	f = 100 kHz			-100		dB
<b>Noise Performance</b>							
E <sub>N</sub>	Input Voltage Noise	f = 0.1 Hz to 10 Hz			1		μV <sub>PP</sub>
e <sub>N</sub>	Input Voltage Noise Density	f = 1 kHz			40		nV/√Hz
i <sub>N</sub>	Input Current Noise	f = 1 kHz			300		fA/√Hz
THD+N	Total Harmonic Distortion and Noise	f = 1 kHz, G = 1, R <sub>L</sub> = 10 kΩ, V <sub>OUT</sub> = 6 V <sub>RMS</sub>			0.005		%

Typical Performance Characteristics

All test conditions:  $V_S = 5\text{ V}$ ,  $T_A = +25^\circ\text{C}$ , unless otherwise noted.

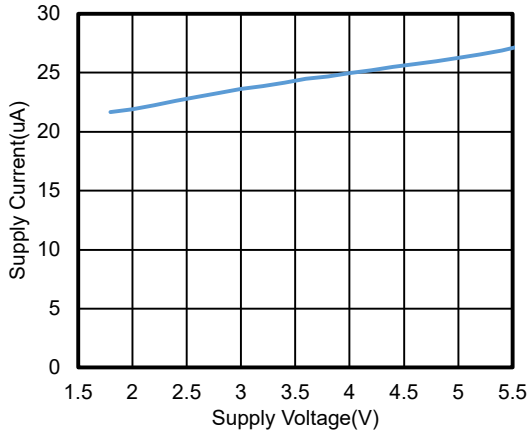


Figure 1. Supply Current vs Supply Voltage, 2ch

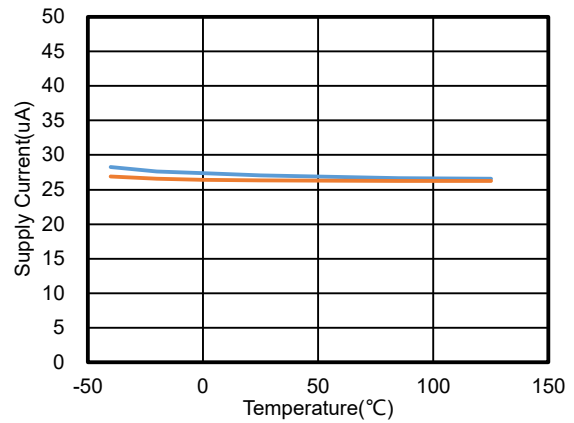


Figure 2. Supply Current vs Temperature, 2ch, 2pcs

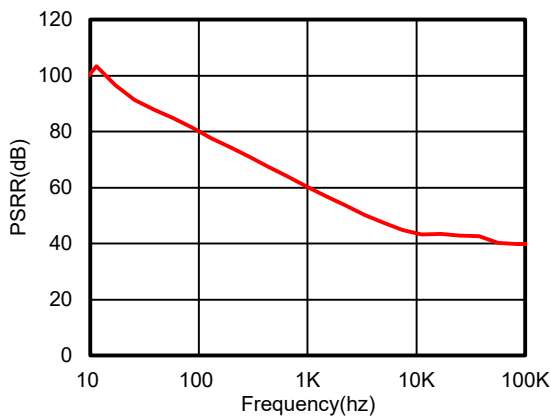


Figure 3. PSRR+ vs Frequency

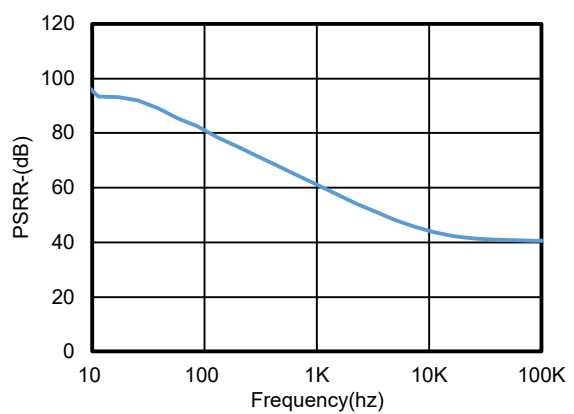


Figure 4. PSRR- vs Frequency

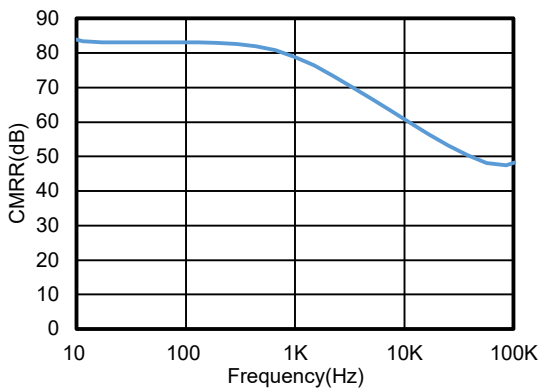


Figure 5. CMRR vs Frequency

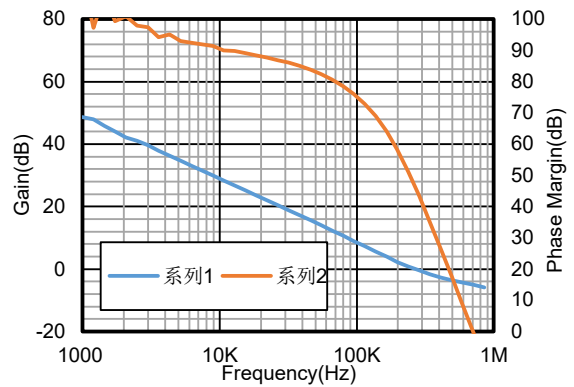


Figure 6. Open Loop Gain and Phase Margin vs Frequency,  $R_L = 10\text{ k}\Omega$ ,  $C_L = 100\text{ pF}$

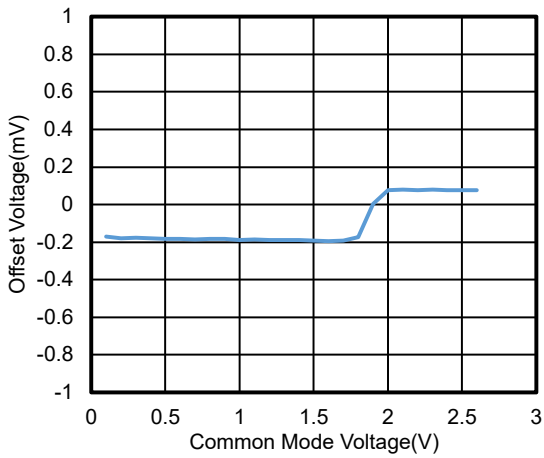


Figure 7.  $V_{OS}$  vs  $V_{CM}$ ,  $V_S = 2.7\text{ V}$

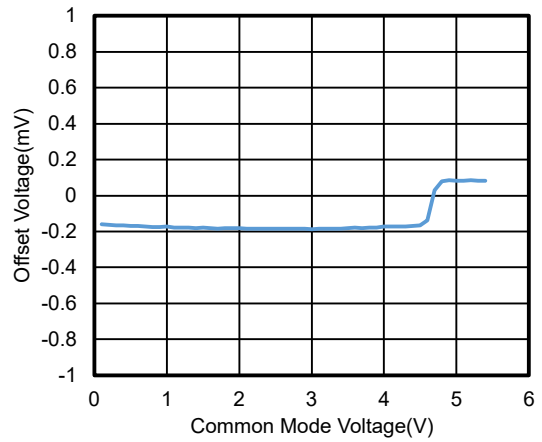


Figure 8.  $V_{OS}$  vs  $V_{CM}$ ,  $V_S = 5.5\text{ V}$

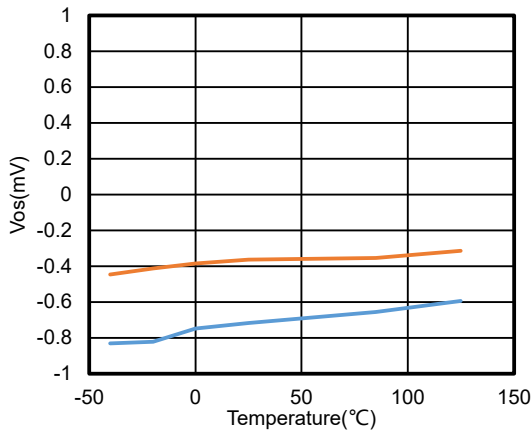


Figure 9.  $V_{OS}$  vs Temperature, 2 pcs

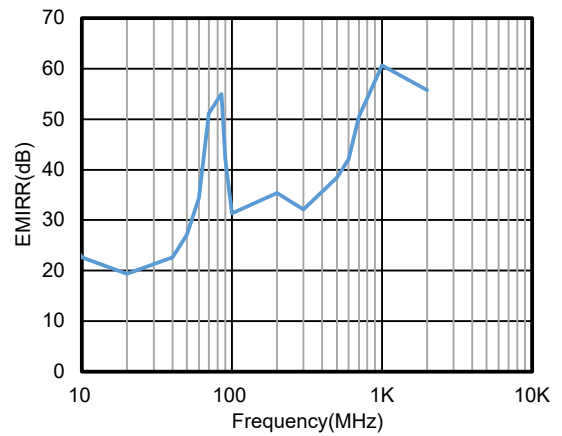


Figure 10. EMIRR vs Frequency

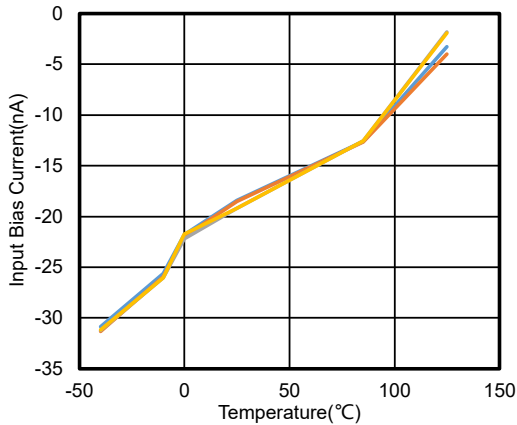


Figure 11.  $I_B$  vs Temperature

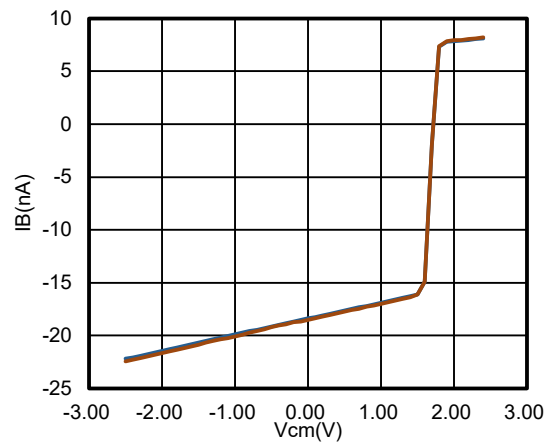


Figure 12.  $I_B$  vs Common Voltage,  $(-V_S) = -2.5\text{ V}$ ,  $(+V_S) = 2.5\text{ V}$

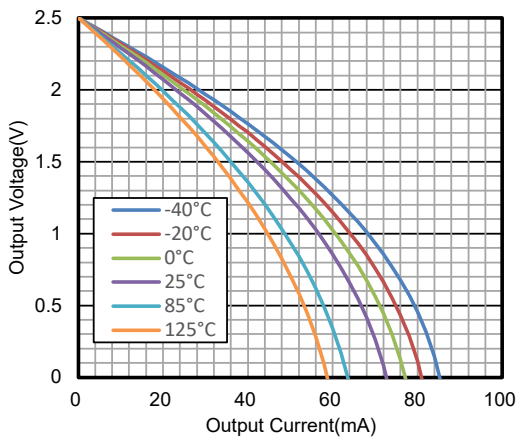


Figure 13. Output Voltage vs Output Current, (-Vs) = -2.5 V, (+Vs) = 2.5 V

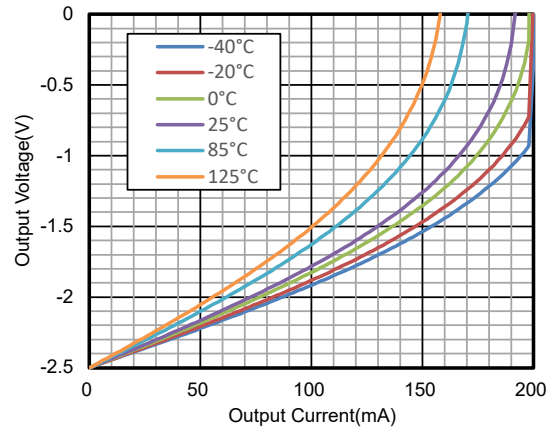


Figure 14. Output Voltage vs Output Current, (-Vs) = -2.5 V, (+Vs) = 2.5 V

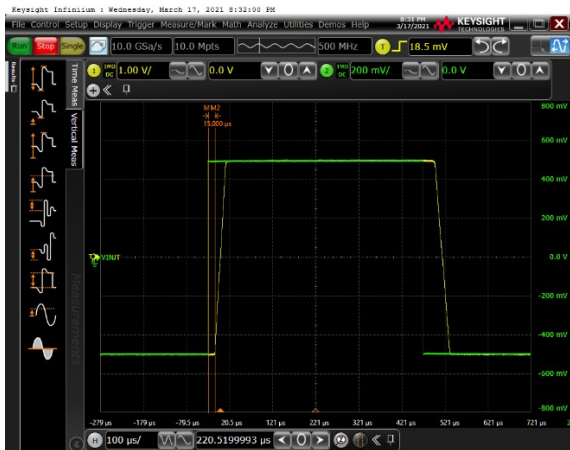


Figure 15. Overload Recovery at Negative Rail



Figure 16. Overload Recovery at Positive Rail



Figure 17. 100-mV Small Signal Step Response

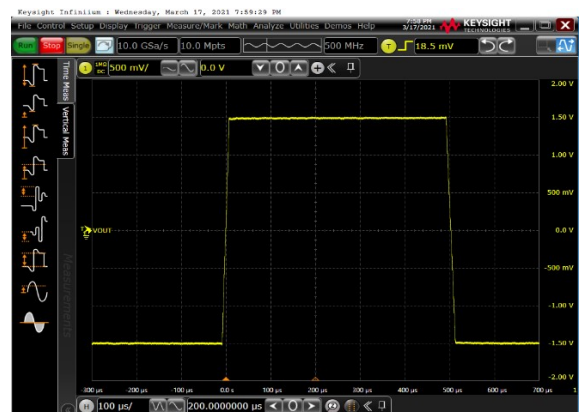


Figure 18. 2-V Large Signal Step Response

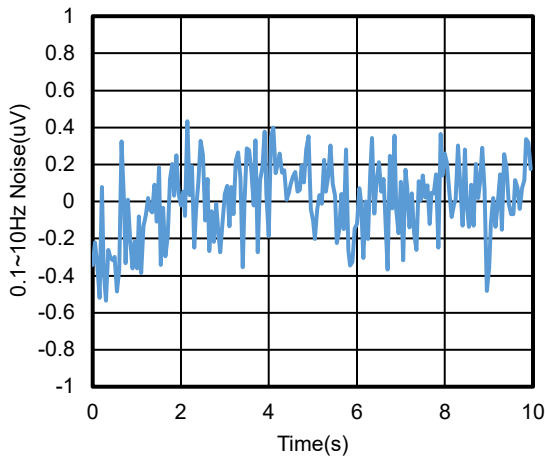


Figure 19. 0.1-Hz to 10-Hz Voltage Noise,  $V_{CM} = 1\text{ V}$

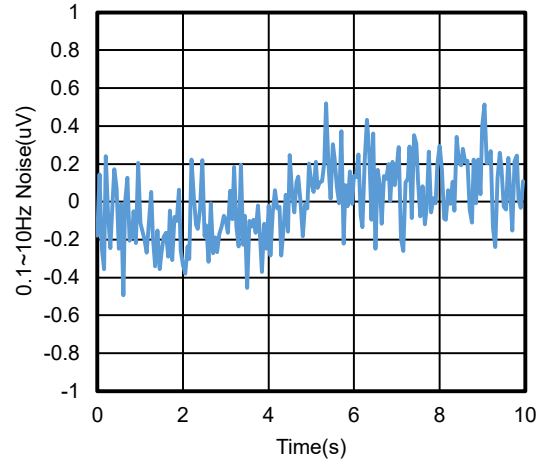


Figure 20. 0.1-Hz to 10-Hz Voltage Noise,  $V_{CM} = 4\text{ V}$

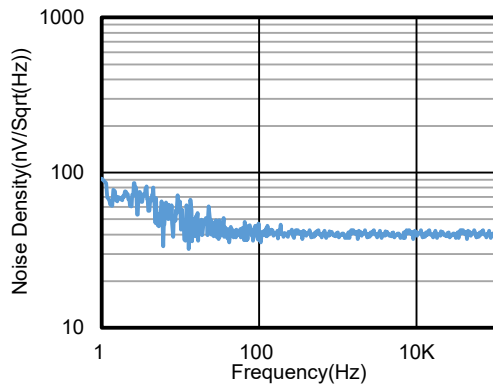


Figure 21. Voltage Noise Spectral Density vs Frequency,  $V_{CM} = 1\text{ V}$

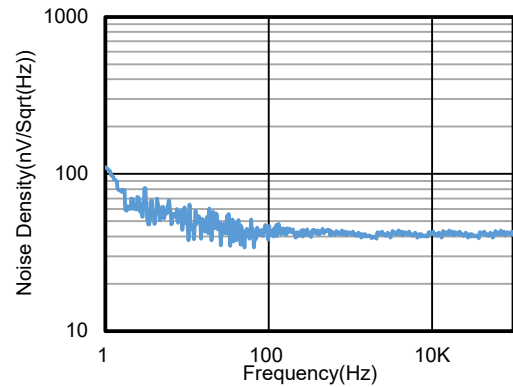


Figure 22. Voltage Noise Spectral Density vs Frequency,  $V_{CM} = 4\text{ V}$

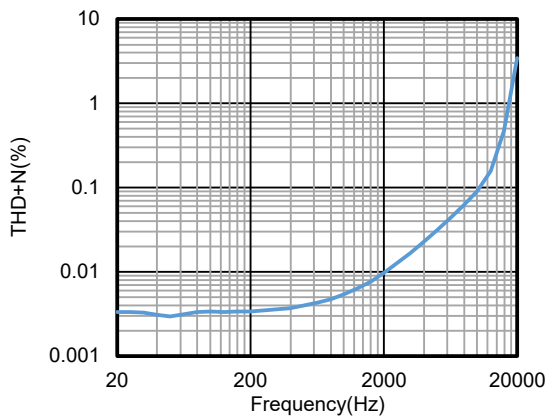


Figure 23. THD vs Frequency,  $G = 1$ ,  $V_{IN} = 1\text{ V}_{RMS}$

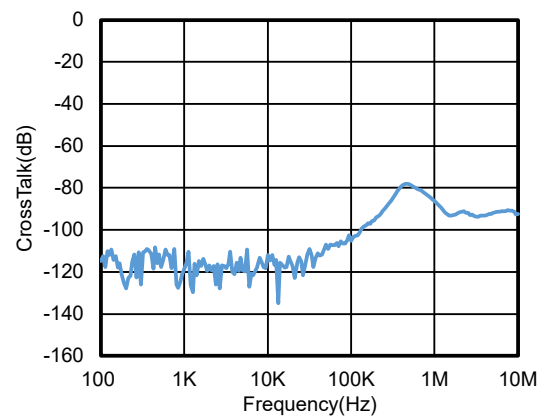


Figure 24. Crosstalk vs Frequency, TPA6532

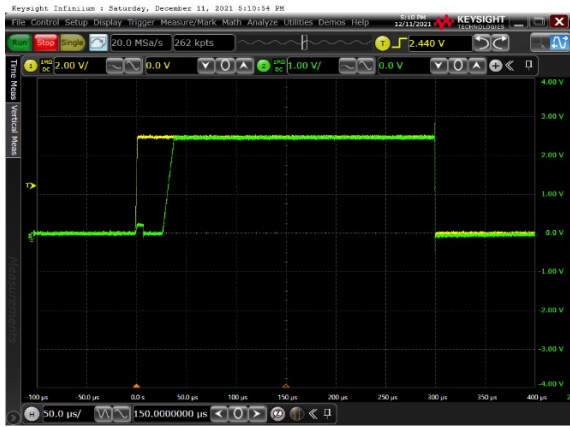


Figure 25. Power On and Off Behavior  $G = 1$ ,  $V_{IN} = 0.5\text{ V}$  during Power On and Off Yellow:  $+V_S$ ; Green: Output

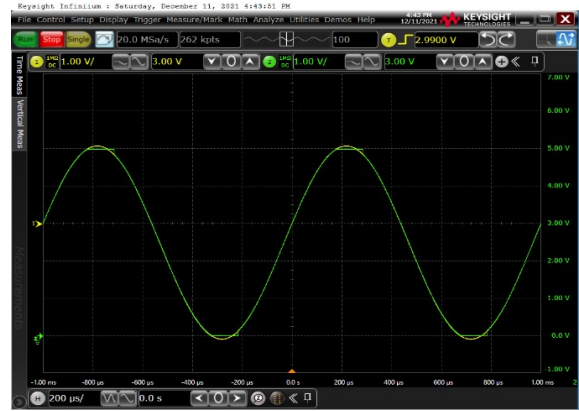


Figure 26. No Phase Reversal Yellow: Input; Green: Output



## Detailed Description

### Overview

The TPA653x series op amps can operate on a single-supply voltage (1.75 V to 5.5 V), or a split-supply voltage ( $\pm 0.875$  V to  $\pm 2.75$  V), making them highly versatile and easy to use. The power-supply pins should have local bypass ceramic capacitors (typically 0.01  $\mu$ F to 0.1  $\mu$ F). These amplifiers are fully specified from 1.75 V to 5.5 V and over the extended temperature range of  $-40^{\circ}\text{C}$  to  $+125^{\circ}\text{C}$ . Parameters that can exhibit variance with regard to operating voltage or temperature are presented in the [Typical Performance Characteristics](#).

### Functional Block Diagram

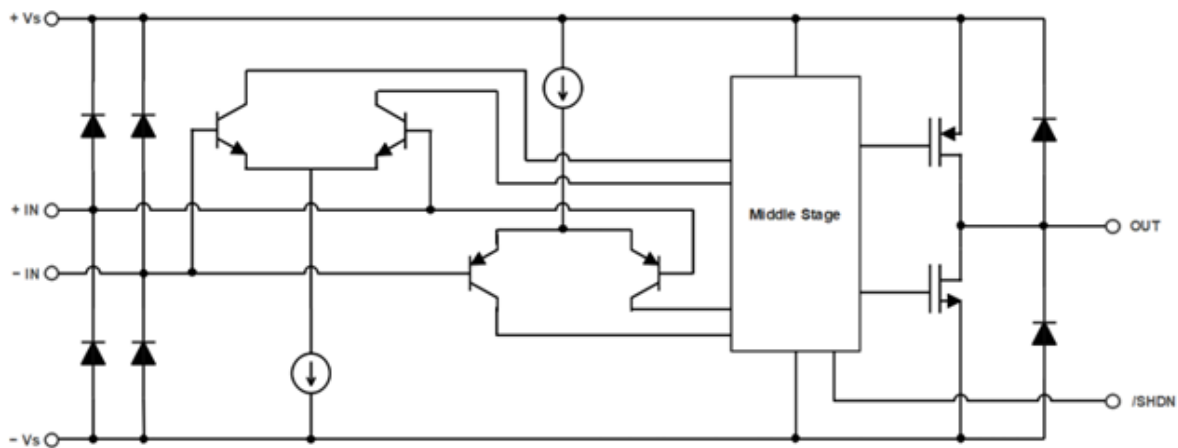


Figure 27. Functional Block Diagram

## Feature Description

### Operating Voltage

The TPA653x family of op amplifiers is designed for single supply operation from 1.75 V to 5.5 V or dual supply operation from  $\pm 0.875$  V to  $\pm 2.75$  V.

### Lower Power

The TPA653x family only draws a maximum 25- $\mu$ A current per channel, it is suitable for low-power application.

### Shutdown

The TPA6531N device supports the shutdown feature, the device uses the /SHDN pin to control the work mode, the device shuts down when the voltage of /SHDN pin is low; the device is activated when the voltage of /SHDN pin is high. The device is active in default by a 10-M $\Omega$  internal pull-up resistor connected to the /SHDN pin.

### Rail-to-Rail Input

The input common-mode voltage range of the TPA653x family extends 100 mV beyond the supply rails. This performance is achieved with a complementary input stage: a PNP input differential pair in parallel with an NPN input differential pair. The PNP pair is active for inputs from 100 mV below the negative supply to approximately  $(+V_S) - 1.5$  V, whereas the NPN pair is

active for input voltages close to the positive rail, typically  $(+V_S) - 1.5\text{ V}$  to 100 mV above the positive supply. There is around 200 mV transition region at  $(+V_S) - 1.5\text{ V}$  where both pairs are on. Within this transition region, PSRR, CMRR, offset voltage, offset drift, and THD can degrade compared to that operating outside this region.

**Rail-to-Rail Output**

The TPA653x family delivers rail-to-rail output swing capability with a class-AB output stage. Different load conditions change the ability of the amplifier to swing close to the rails.

**Low 1/f Input Voltage Noise**

The TPA653x family uses bipolar transistor as input pair which brings very low 1/f voltage noise, the 1/f corner frequency of the device is lower than 100 Hz. The input voltage noise at 0.1 to 10 Hz is  $1\ \mu\text{V}_{\text{PP}}$ , so the device is very suitable for applications that need low noise within the low-frequency range.

## Application and Implementation

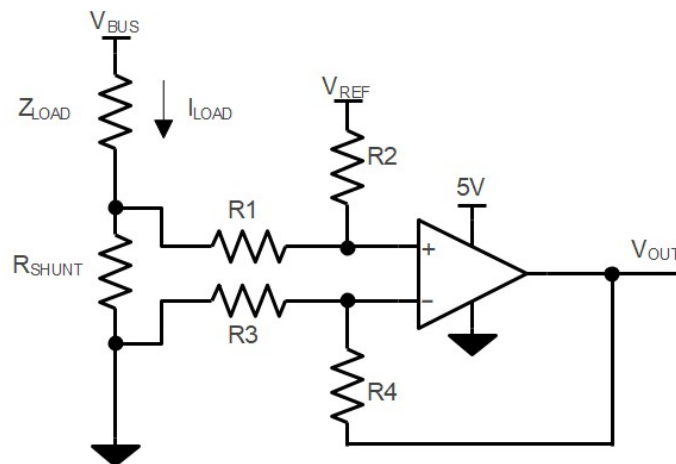
Note

Information in the following application sections is not part of the 3PEAK's component specification and 3PEAK does not warrant its accuracy or completeness. 3PEAK's customers are responsible for determining suitability of components for their purposes. Customers should validate and test their design implementation to confirm system functionality.

## Application Information

### Low Side Current Sensing Application

Figure 28 shows the TPA653x configured in a low-side current sensing application. The low-side current sensing method consists of placing a sense resistor between the load and the circuit ground. The voltage dropping across the resistor is amplified by different amplifier circuits with the TPA653x. The  $V_{REF}$  can be used to add bias voltage to output voltage. Particular attention must be paid to the matching and precision of R1, R2, R3, and R4, to maximize the accuracy of the measurement.



$$V_{OUT} = (I_{LOAD} \times R_{SHUNT}) \times (R2 / R1) + V_{REF}$$

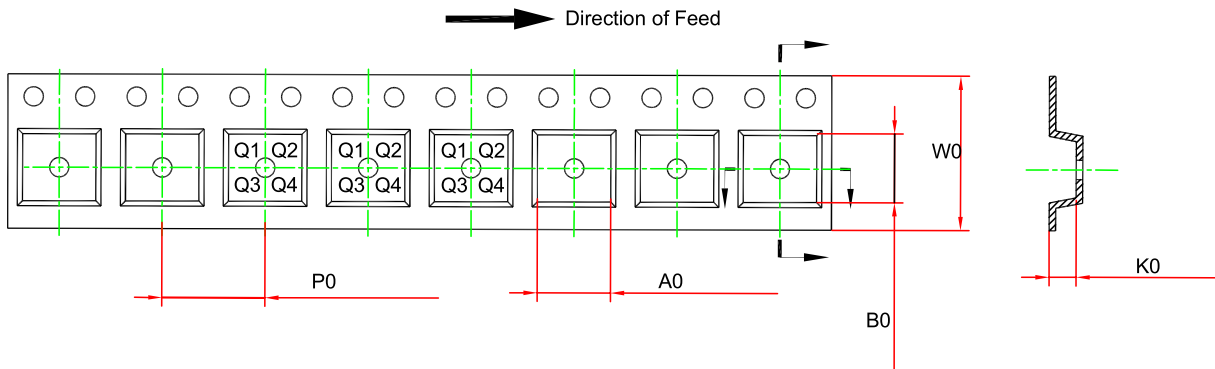
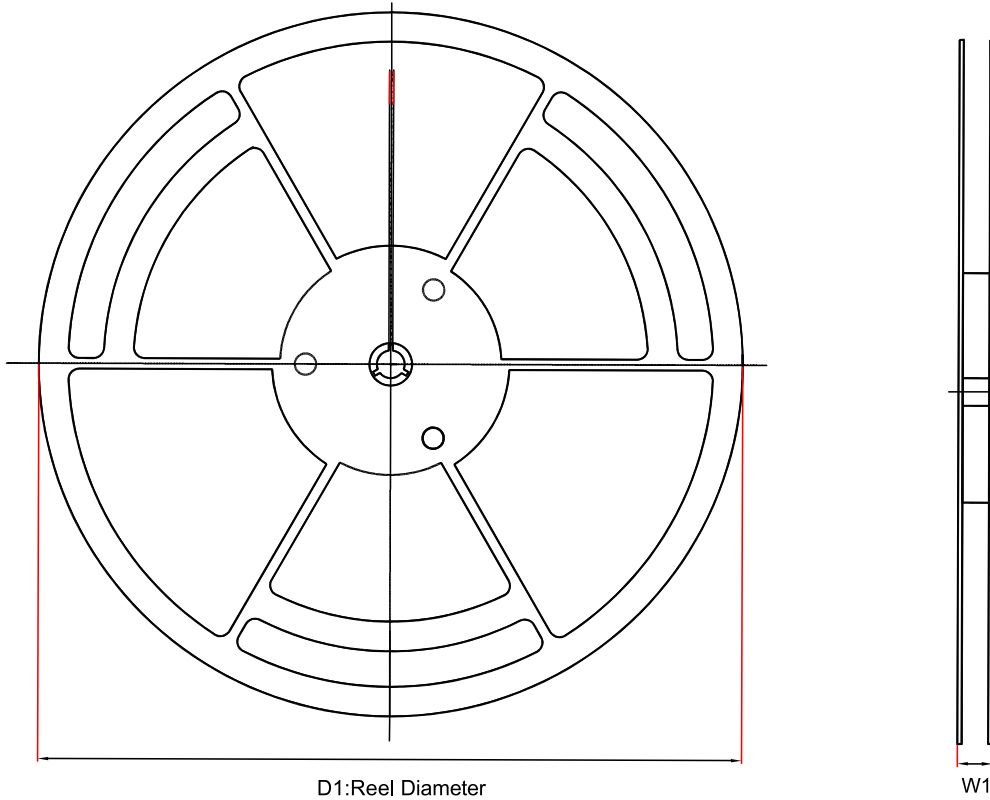
$$\text{When } R3 = R1, R2 = R4, R_{SHUNT} \ll R1$$

**Figure 28. Dual Supply Operation Connections**

### Power Supply Recommendations

Place 0.1- $\mu$ F bypass capacitors close to the power supply pins for reducing coupling errors from the noisy or high-impedance power supplies.

### Tape and Reel Information

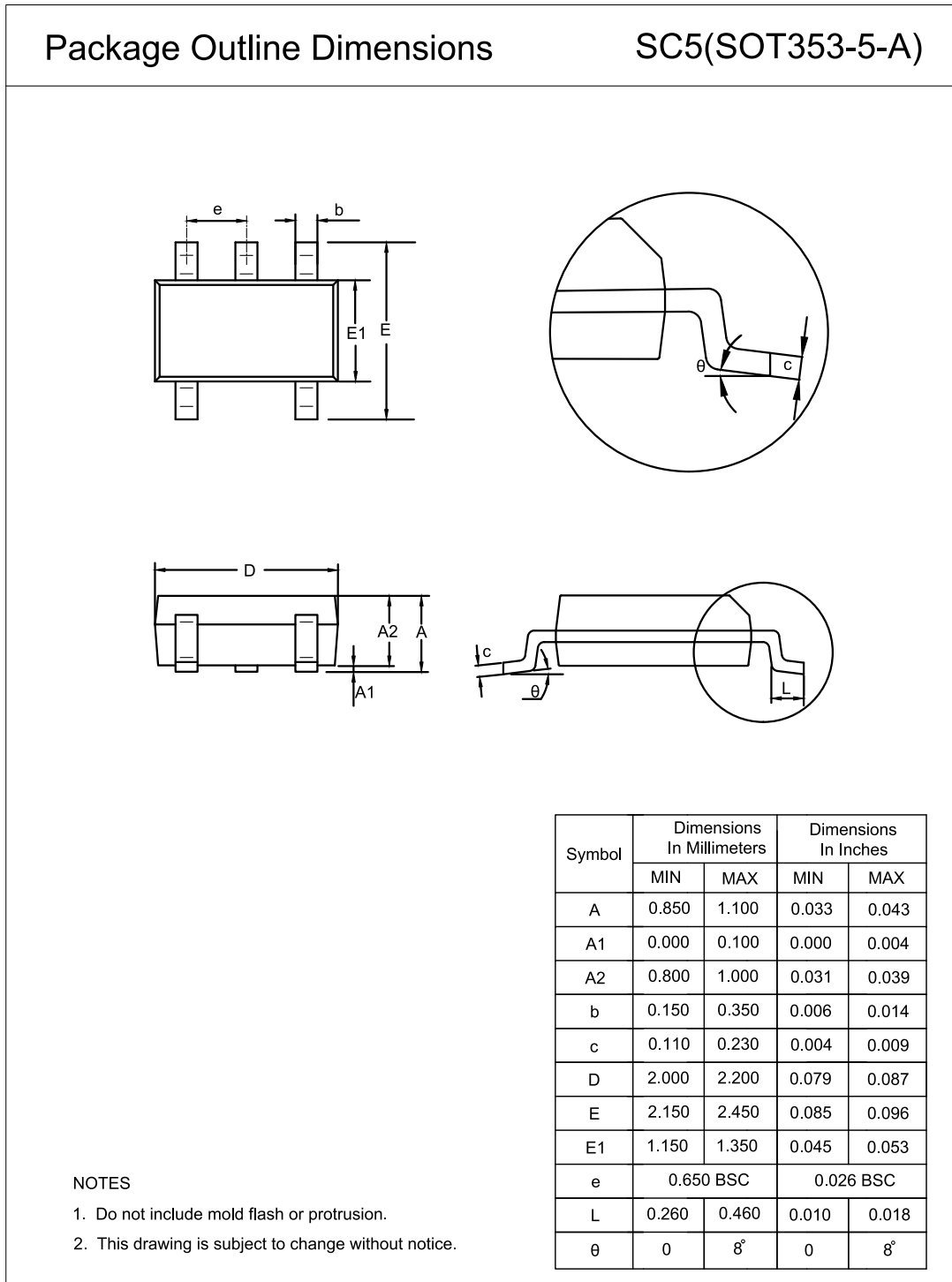


Order Number	Package	D1 (mm)	W1 (mm)	A0 (mm)	B0 (mm)	K0 (mm)	P0 (mm)	W0 (mm)	Pin1 Quadrant
TPA6531-SC5R	SOT353-5 (SC70)	178.0	12.3	2.4	2.5	1.2	4.0	8.0	Q3
TPA6531-S5TR	SOT23-5	180.0	13.1	3.2	3.2	1.4	4.0	8.0	Q3
TPA6531U-S5TR	SOT23-5	180.0	13.1	3.2	3.2	1.4	4.0	8.0	Q3
TPA6531N-S6TR	SOT23-6	180.0	13.1	3.2	3.2	1.4	4.0	8.0	Q3
TPA6532-SO1R	SOP8	330.0	17.6	6.4	5.4	2.1	8.0	12.0	Q1

Order Number	Package	D1 (mm)	W1 (mm)	A0 (mm)	B0 (mm)	K0 (mm)	P0 (mm)	W0 (mm)	Pin1 Quadrant
TPA6532-VS1R	MSOP8	330.0	17.6	5.2	3.3	1.5	8.0	12.0	Q1
TPA6534-SO2R	SOP14	330.0	21.6	6.5	9.0	2.1	8.0	16.0	Q1
TPA6534-TS2R	TSSOP14	330.0	17.6	6.8	5.4	1.2	8.0	12.0	Q1

Package Outline Dimensions

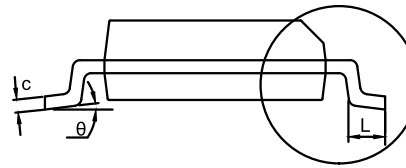
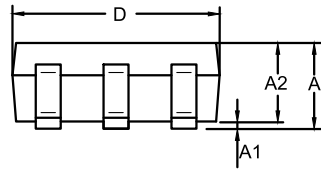
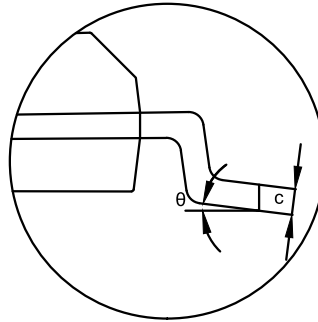
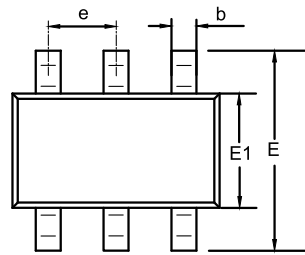
SOT353-5



SOT363-6

Package Outline Dimensions

SC6(SOT363-6-A)



Symbol	Dimensions In Millimeters		Dimensions In Inches	
	MIN	MAX	MIN	MAX
A	0.850	1.100	0.033	0.043
A1	0.000	0.100	0.000	0.004
A2	0.800	1.000	0.031	0.039
b	0.150	0.350	0.006	0.014
c	0.080	0.230	0.003	0.009
D	2.000	2.200	0.079	0.087
E	2.150	2.450	0.085	0.096
E1	1.150	1.350	0.045	0.053
e	0.650 BSC		0.026 BSC	
L	0.260	0.460	0.010	0.018
θ	0	8°	0	8°

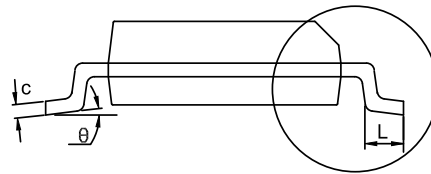
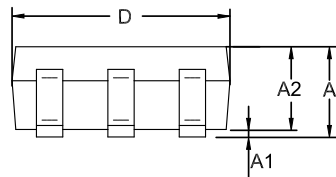
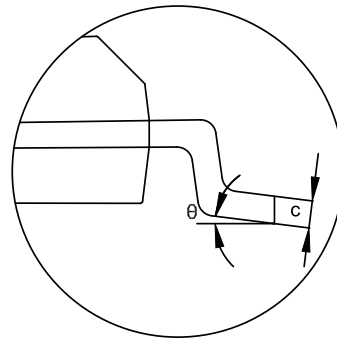
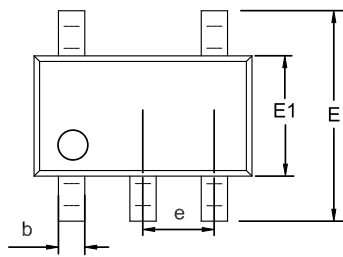
NOTES

1. Do not include mold flash or protrusion.
2. This drawing is subject to change without notice.

SOT23-5

Package Outline Dimensions

S5T(SOT23-5-A)



Symbol	Dimensions In Millimeters		Dimensions In Inches	
	MIN	MAX	MIN	MAX
A	1.050	1.250	0.041	0.049
A1	0.000	0.150	0.000	0.006
A2	1.000	1.200	0.039	0.047
b	0.280	0.500	0.011	0.020
c	0.100	0.230	0.004	0.009
D	2.820	3.020	0.111	0.119
E	2.600	3.000	0.102	0.118
E1	1.500	1.720	0.059	0.068
e	0.950 BSC		0.037 BSC	
L	0.300	0.600	0.012	0.024
$\theta$	0	8°	0	8°

NOTES

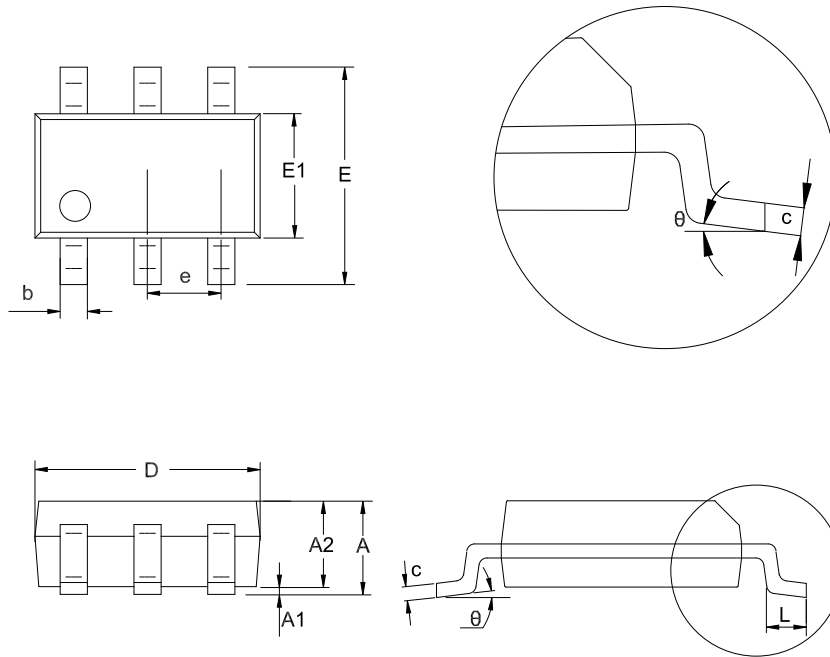
1. Do not include mold flash or protrusion.
2. This drawing is subject to change without notice.



SOT23-6

Package Outline Dimensions

S6T(SOT23-6-A)



Symbol	Dimensions In Millimeters		Dimensions In Inches	
	MIN	MAX	MIN	MAX
A	1.050	1.250	0.041	0.049
A1	0.000	0.150	0.000	0.006
A2	1.000	1.200	0.039	0.047
b	0.280	0.500	0.011	0.020
c	0.100	0.230	0.004	0.009
D	2.820	3.020	0.111	0.119
E	2.600	3.000	0.102	0.118
E1	1.500	1.720	0.059	0.068
e	0.950 BSC		0.037 BSC	
L	0.300	0.600	0.012	0.024
theta	0	8°	0	8°

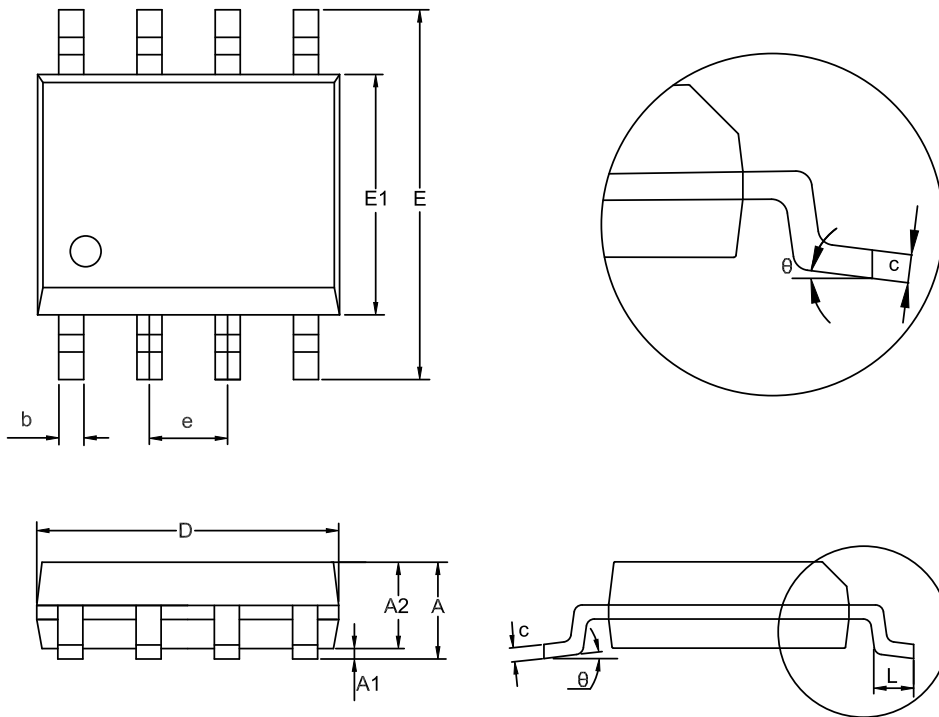
NOTES

1. Do not include mold flash or protrusion.
2. This drawing is subject to change without notice.

SOP8

Package Outline Dimensions

SO1(SOP-8-A)



Symbol	Dimensions In Millimeters		Dimensions In Inches	
	MIN	MAX	MIN	MAX
A	1.350	1.750	0.053	0.069
A1	0.050	0.250	0.002	0.010
A2	1.250	1.550	0.049	0.061
b	0.330	0.510	0.013	0.020
c	0.170	0.250	0.007	0.010
D	4.700	5.100	0.185	0.201
E	5.800	6.200	0.228	0.244
E1	3.800	4.000	0.150	0.157
e	1.270 BSC		0.050 BSC	
L	0.400	1.000	0.016	0.039
theta	0	8°	0	8°

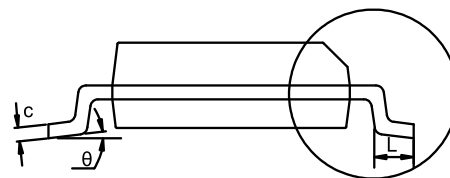
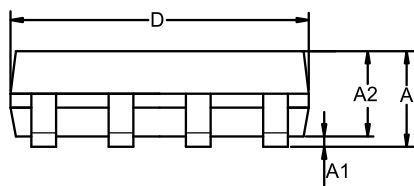
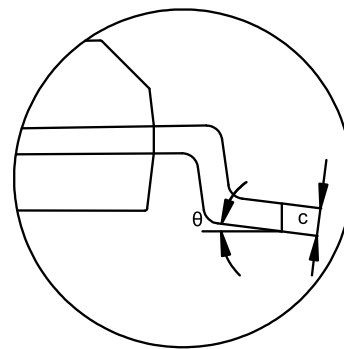
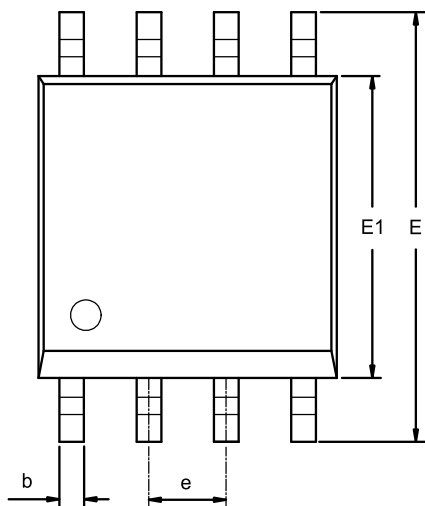
NOTES

1. Do not include mold flash or protrusion.
2. This drawing is subject to change without notice.

MSOP8

Package Outline Dimensions

VS1(MSOP-8-A)



Symbol	Dimensions In Millimeters		Dimensions In Inches	
	MIN	MAX	MIN	MAX
A	0.800	1.100	0.031	0.043
A1	0.020	0.150	0.001	0.006
A2	0.750	0.950	0.030	0.037
b	0.250	0.380	0.010	0.015
c	0.090	0.230	0.004	0.009
D	2.900	3.100	0.114	0.122
E	4.700	5.100	0.185	0.201
E1	2.900	3.100	0.114	0.122
e	0.650 BSC		0.026 BSC	
L	0.400	0.800	0.016	0.031
$\theta$	0	8°	0	8°

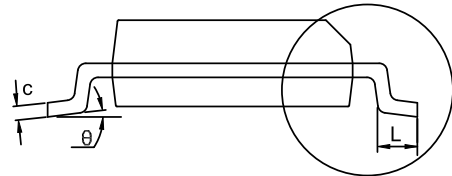
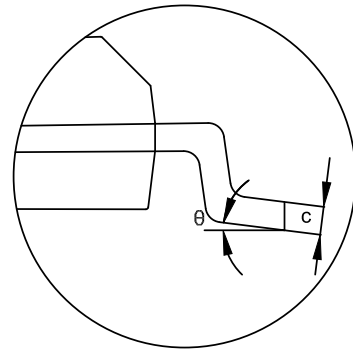
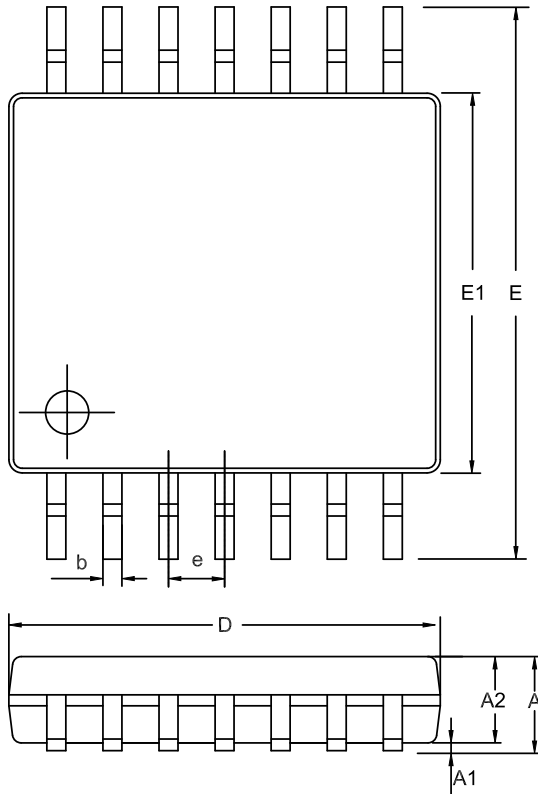
NOTES

1. Do not include mold flash or protrusion.
2. This drawing is subject to change without notice.

TSSOP14

Package Outline Dimensions

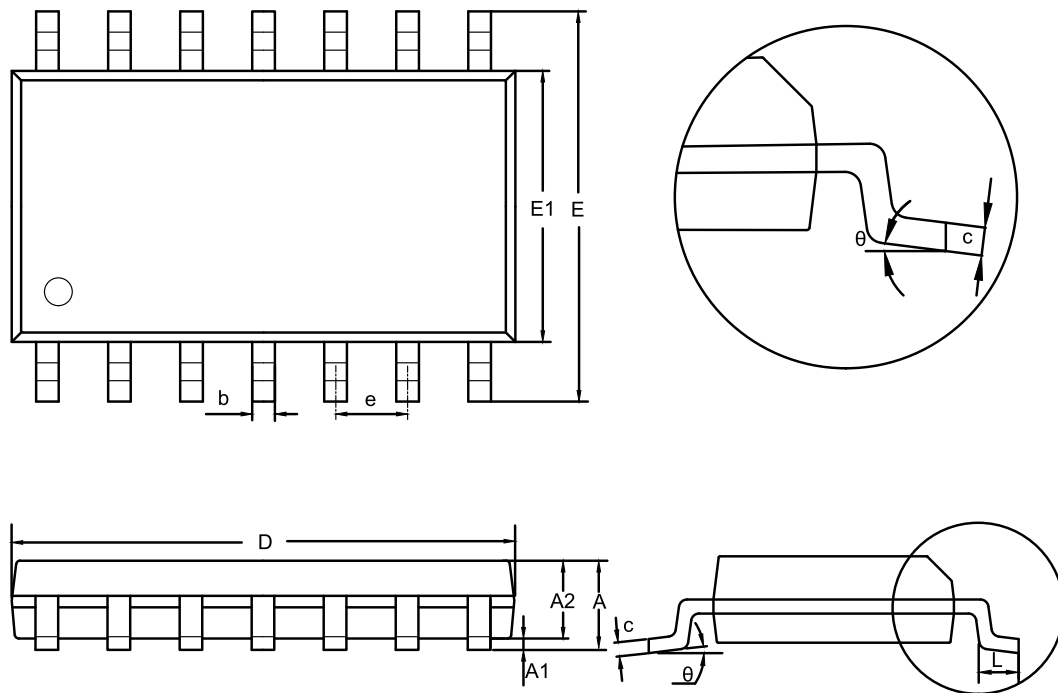
TS2(TSSOP-14-A)



Symbol	Dimensions In Millimeters		Dimensions In Inches	
	MIN	MAX	MIN	MAX
A	0.900	1.200	0.035	0.047
A1	0.050	0.150	0.002	0.006
A2	0.800	1.050	0.031	0.041
b	0.190	0.300	0.007	0.012
c	0.090	0.200	0.004	0.008
D	4.900	5.100	0.193	0.201
E	6.200	6.600	0.244	0.260
E1	4.300	4.500	0.169	0.177
e	0.650 BSC		0.026 BSC	
L	0.450	0.750	0.018	0.030
$\theta$	0	8°	0	8°

NOTES

1. Do not include mold flash or protrusion.
2. This drawing is subject to change without notice.

**SOP14**
**Package Outline Dimensions**
**SO2(SOP-14-A)**


Symbol	Dimensions In Millimeters		Dimensions In Inches	
	MIN	MAX	MIN	MAX
A	1.350	1.750	0.053	0.069
A1	0.050	0.250	0.002	0.010
A2	1.250	1.650	0.049	0.065
b	0.310	0.510	0.012	0.020
c	0.100	0.250	0.004	0.010
D	8.450	8.850	0.333	0.348
E	5.800	6.200	0.228	0.244
E1	3.800	4.000	0.150	0.157
e	1.270 BSC		0.050 BSC	
L	0.400	1.270	0.016	0.050
θ	0	8°	0	8°

**NOTES**

1. Do not include mold flash or protrusion.
2. This drawing is subject to change without notice.

**Order Information**

Order Number	Operating Temperature Range	Package	Marking Information	MSL	Transport Media, Quantity	Eco Plan
TPA6531-SC5R	-40 to 125°C	SOT353 (SC70-5)	653	3	Tape and Reel, 3000	Green
TPA6531U-SC5R <sup>(1)</sup>	-40 to 125°C	SOT353 (SC70-5)	63U	3	Tape and Reel, 3000	Green
TPA6531-S5TR	-40 to 125°C	SOT23-5	653	3	Tape and Reel, 3000	Green
TPA6531U-S5TR	-40 to 125°C	SOT23-5	63U	3	Tape and Reel, 3000	Green
TPA6531N-S6TR	-40 to 125°C	SOT23-6	63N	3	Tape and Reel, 3000	Green
TPA6531N-SC6R <sup>(1)</sup>	-40 to 125°C	SOT363 (SC70-6)	63N	3	Tape and Reel, 3000	Green
TPA6532-SO1R	-40 to 125°C	SOP8	A6532	3	Tape and Reel, 4000	Green
TPA6532-DF4R <sup>(1)</sup>	-40 to 125°C	DFN2X2-8	653	3	Tape and Reel, 3000	Green
TPA6532-TS1R <sup>(1)</sup>	-40 to 125°C	TSSOP8	A6532	3	Tape and Reel, 3000	Green
TPA6532-VS1R	-40 to 125°C	MSOP8	A6532	3	Tape and Reel, 3000	Green
TPA6534-SO2R	-40 to 125°C	SOP14	A6534	3	Tape and Reel, 2500	Green
TPA6534-TS2R	-40 to 125°C	TSSOP14	A6534	3	Tape and Reel, 3000	Green

(1) For future products, contact the 3PEAK factory for more information and sample.

**Green:** 3PEAK defines "Green" to mean RoHS compatible and free of halogen substances.

## IMPORTANT NOTICE AND DISCLAIMER

**Copyright**© 3PEAK 2012-2023. All rights reserved.

**Trademarks.** Any of the 思瑞浦 or 3PEAK trade names, trademarks, graphic marks, and domain names contained in this document /material are the property of 3PEAK. You may NOT reproduce, modify, publish, transmit or distribute any Trademark without the prior written consent of 3PEAK.

**Performance Information.** Performance tests or performance range contained in this document/material are either results of design simulation or actual tests conducted under designated testing environment. Any variation in testing environment or simulation environment, including but not limited to testing method, testing process or testing temperature, may affect actual performance of the product.

**Disclaimer.** 3PEAK provides technical and reliability data (including data sheets), design resources (including reference designs), application or other design recommendations, networking tools, security information and other resources "As Is". 3PEAK makes no warranty as to the absence of defects, and makes no warranties of any kind, express or implied, including without limitation, implied warranties as to merchantability, fitness for a particular purpose or non-infringement of any third-party's intellectual property rights. Unless otherwise specified in writing, products supplied by 3PEAK are not designed to be used in any life-threatening scenarios, including critical medical applications, automotive safety-critical systems, aviation, aerospace, or any situations where failure could result in bodily harm, loss of life, or significant property damage. 3PEAK disclaims all liability for any such unauthorized use.

This page intentionally left blank