

TOSHIBA Intelligent Power Device High Voltage Monolithic Silicon Power IC

# TPD4112K

The TPD4112K is a DC brush less motor driver using high voltage PWM control. It is fabricated by high voltage SOI process.

It contains bootstrap circuit, PWM circuit, 3-phase decode logic, level shift high-side driver, low-side driver, IGBT outputs, FRDs, over current and under voltage protection circuits, and thermal shutdown circuit.

It is easy to control a DC brush less motor by applying a signal from a motor controller and a hall amp/ hall IC to the TPD4112K.

## Features

- Bootstrap circuit gives simple high side supply.
- Bootstrap diode is built in.
- PWM and 3-phase decoder circuit are built in.
- 3-phase bridge output using IGBTs.
- Outputs Rotation pulse signals.
- FRDs are built in.
- Incorporating over current and under voltage protection, and thermal shutdown.
- Package: 23-pin HZIP.
- It corresponds to the hall amp input and the hall IC input.

This product has a MOS structure and is sensitive to electrostatic discharge. When handling this product, ensure that the environment is protected against electrostatic discharge.

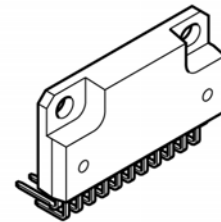

HZIP23-P-1.27F (LBR)

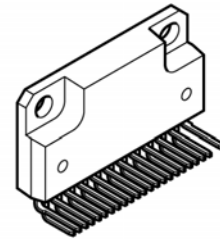

HZIP23-P-1.27G (LBF)

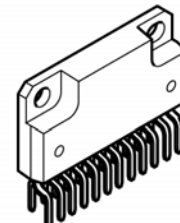

HZIP23-P-1.27H (LB2)

### Weight

HZIP23-P-1.27F : 6.1 g (typ.)

HZIP23-P-1.27G : 6.1 g (typ.)

HZIP23-P-1.27H : 6.1 g (typ.)

**Pin Assignment**

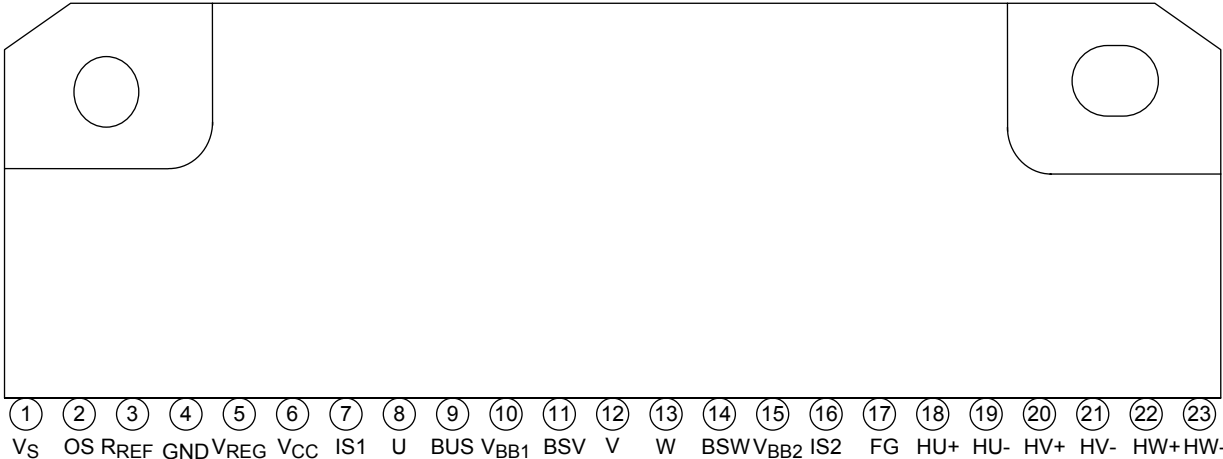

**Marking**

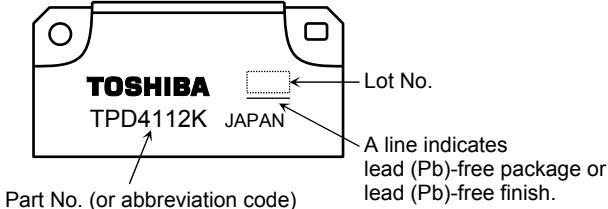

**Block Diagram**

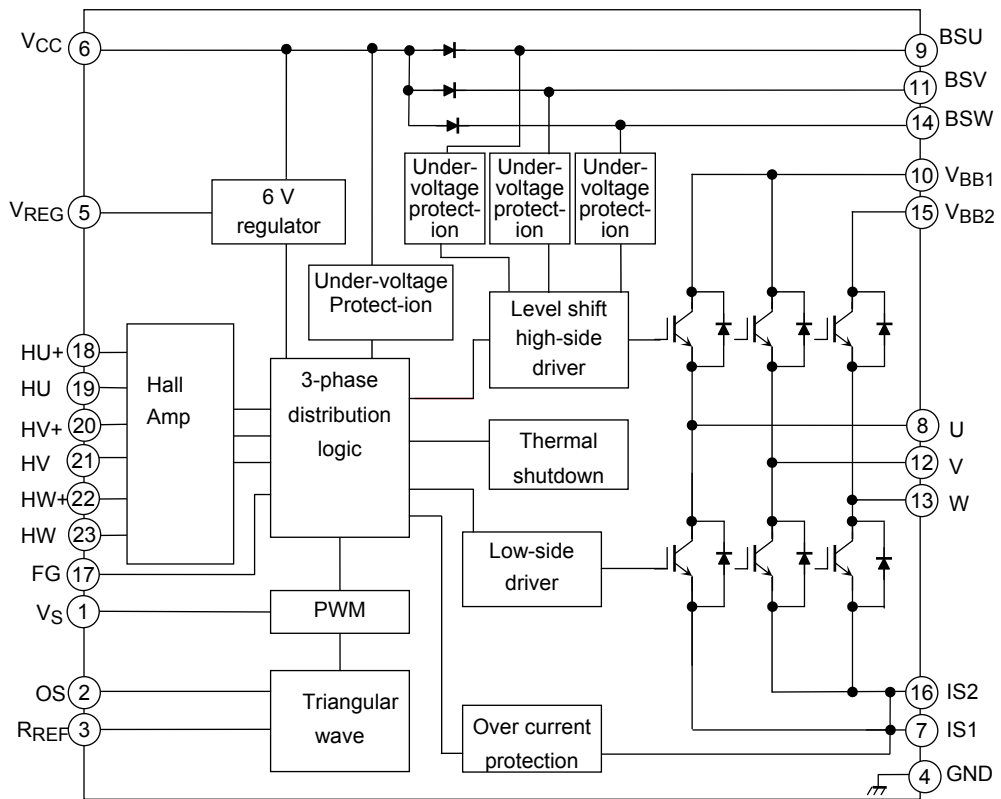

**Pin Description**

Pin No.	Symbol	Pin Description
1	V <sub>S</sub>	Speed control signal input pin. (PWM reference voltage input pin)
2	OS	PWM triangular wave oscillation frequency setup pin (Connect a capacitor to this pin.)
3	R <sub>REF</sub>	PWM triangular wave oscillation frequency setup pin (Connect a resistor to this pin.)
4	GND	Ground pin
5	V <sub>REG</sub>	6 V regulator output pin
6	V <sub>CC</sub>	Control power supply pin
7	IS1	IGBT emitter/FRD anode pin (Connect a current detecting resistor to this pin.)
8	U	U-phase output pin
9	BUS	U-phase bootstrap capacitor connecting pin
10	V <sub>BB1</sub>	U and V-phase high-voltage power supply input pin
11	BSV	V-phase bootstrap capacitor connecting pin
12	V	V-phase output pin
13	W	W-phase high-voltage power supply input pin
14	BSW	W-phase bootstrap capacitor connecting pin
15	V <sub>BB2</sub>	W-phase high-voltage power supply input pin
16	IS2	IGBT emitter/FRD anode pin (Connect a current detecting resistor to this pin.)
17	FG	Rotation pulse output pin. (open drain)
18	HU+	U-phase hall sensor signal input pin (Hall IC can be used.)
19	HU-	U-phase hall sensor signal input pin (Hall IC can be used.)
20	HV+	V-phase hall sensor signal input pin (Hall IC can be used.)
21	HV-	V-phase hall sensor signal input pin (Hall IC can be used.)
22	HW+	W-phase hall sensor signal input pin (Hall IC can be used.)
23	HW-	W-phase hall sensor signal input pin (Hall IC can be used.)

**Equivalent Circuit of Input Pins**

**Internal circuit diagram of HU+, HU-, HV+, HV-, HW+, HW- input pins**

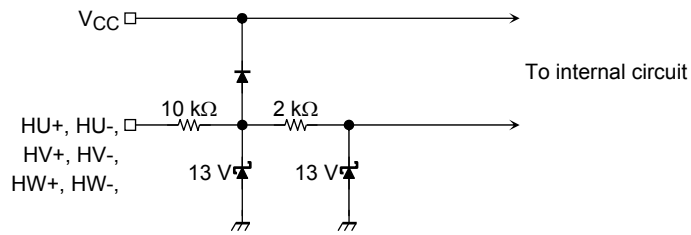

**Internal circuit diagram of Vs pin**

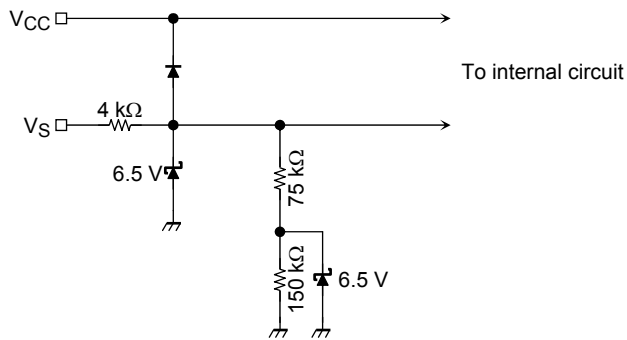

**Internal circuit diagram of FG pin**

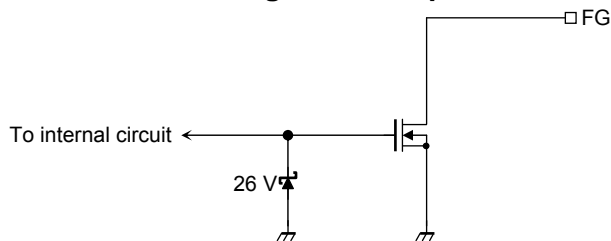

**Timing Chart**

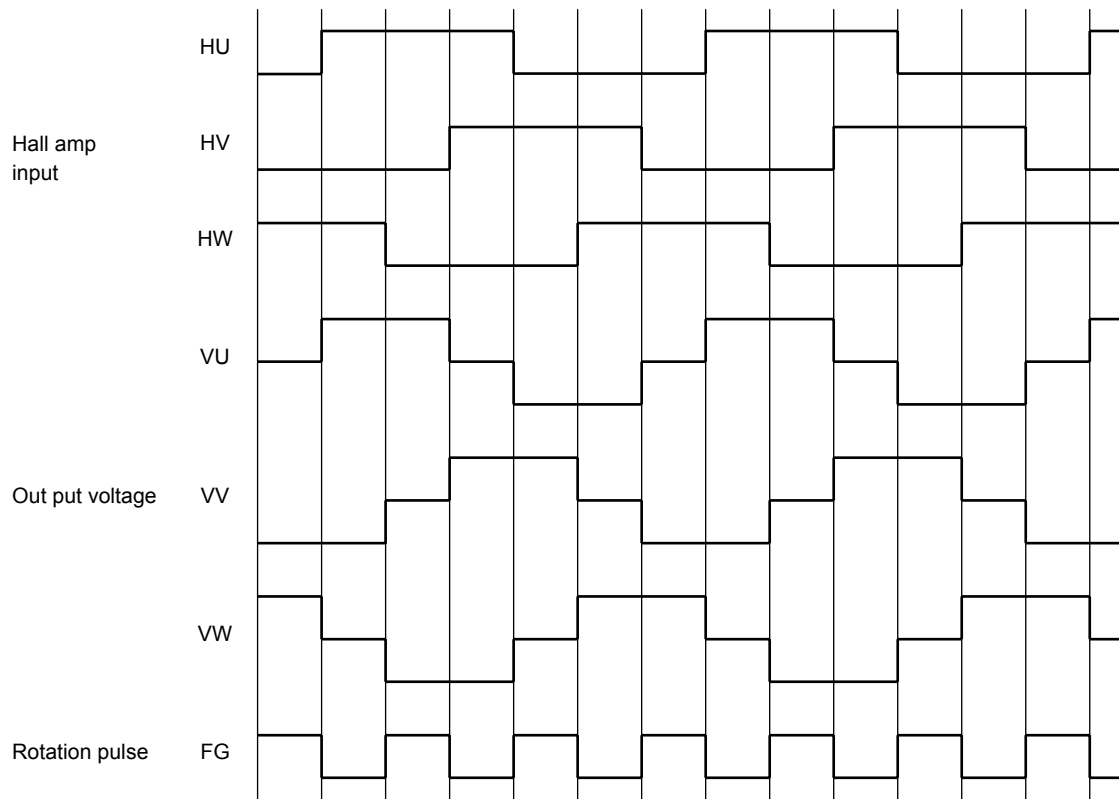

\* : As for "H", a hall amp input state shows the state of IN+>IN - .

**Truth Table**

Hall amp Input			U Phase		V Phase		W Phase		FG
HU	HV	HW	Upper Arm	Lower Arm	Upper Arm	Lower Arm	Upper Arm	Lower Arm	
H	L	H	ON	OFF	OFF	ON	OFF	OFF	L
H	L	L	ON	OFF	OFF	OFF	OFF	ON	H
H	H	L	OFF	OFF	ON	OFF	OFF	ON	L
L	H	L	OFF	ON	ON	OFF	OFF	OFF	H
L	H	H	OFF	ON	OFF	OFF	ON	OFF	L
L	L	H	OFF	OFF	OFF	ON	ON	OFF	H
L	L	L	OFF	OFF	OFF	OFF	OFF	OFF	L
H	H	H	OFF	OFF	OFF	OFF	OFF	OFF	L

\* : As for "H", a hall amp input state shows the state of IN+>IN - .

## Absolute Maximum Ratings (Ta = 25°C)

Characteristics	Symbol	Rating	Unit
Power supply voltage	V <sub>BB</sub>	500	V
	V <sub>CC</sub>	20	V
Output current (DC)	I <sub>out</sub>	1	A
Output current (pulse)	I <sub>out</sub>	2	A
Input voltage (except V <sub>S</sub> )	V <sub>IN</sub>	-0.5 to V <sub>REG</sub> + 0.5	V
Input voltage (only V <sub>S</sub> )	V <sub>V<sub>S</sub></sub>	8.2	V
V <sub>REG</sub> current	I <sub>REG</sub>	50	mA
Power dissipation (Ta = 25°C)	P <sub>C</sub>	4	W
Power dissipation (Tc = 25°C)	P <sub>C</sub>	20	W
Operating junction temperature	T <sub>jopr</sub>	-20 to 135	°C
Junction temperature	T <sub>j</sub>	150	°C
Storage temperature	T <sub>stg</sub>	-55 to 150	°C
Lead-heat sink isolation voltage	V <sub>hs</sub>	1000 (1 min)	V <sub>rms</sub>

## Electrical Characteristics (Ta = 25°C)

Characteristics	Symbol	Test Condition	Min	Typ.	Max	Unit
Operating power supply voltage	V <sub>BB</sub>	—	50	—	400	V
	V <sub>CC</sub>	—	13.5	15	17.5	
Current dissipation	I <sub>BB</sub>	V <sub>BB</sub> = 400 V Duty cycle = 0%	—	—	0.5	mA
	I <sub>CC</sub>	V <sub>CC</sub> = 15 V Duty cycle = 0%	—	1.8	10	
	I <sub>BS (ON)</sub>	V <sub>BS</sub> = 15 V, high side ON	—	210	470	
	I <sub>BS (OFF)</sub>	V <sub>BS</sub> = 15V, high side OFF	—	200	415	
Hall amp input sensitivity	VHSENS(HA)	—	50	—	—	mvp-p
Hall amp Input current	IHB(HA)	—	-2	0	2	μA
Hall amp this minister input	CMVIN(HA)	—	0	—	8	V
Hall amp hysteresis width	VIN(HA)	—	20	30	50	mV
Hall amp input voltage L H	VLH(HA)	—	5	15	25	
Hall amp input voltage H L	VHL(HA)	—	-15	-15	-5	
Output saturation voltage	V <sub>CEsatH</sub>	V <sub>CC</sub> = 15 V, I <sub>C</sub> = 0.5 A	—	2.3	3.0	V
	V <sub>CesatL</sub>	V <sub>CC</sub> = 15 V, I <sub>C</sub> = 0.5 A	—	2.3	3.0	
FRD forward voltage	V <sub>FH</sub>	I <sub>F</sub> = 0.5 A, high side	—	1.4	2.1	V
	V <sub>FL</sub>	I <sub>F</sub> = 0.5 A, low side	—	1.4	1.8	
FRD forward voltage	V <sub>F (BSD)</sub>	I <sub>F</sub> = 500 μA	—	0.8	1.2	V
PWM ON-duty cycle	PWMMIN	—	0	—	—	%
	PWMMAX	—	—	—	100	
PWM ON-duty cycle, 0%	V <sub>Vs0%</sub>	PWM = 0%	1.7	2.1	2.5	V
PWM ON-duty cycle, 100%	V <sub>Vs100%</sub>	PWM = 100%	4.9	5.4	6.1	V
PWM ON-duty voltage range	V <sub>VsW</sub>	V <sub>Vs100%</sub> – V <sub>Vs0%</sub>	2.8	3.3	3.8	V
Output all-OFF voltage	V <sub>VsOFF</sub>	Output all OFF	1.1	1.3	1.5	V
Regulator voltage	V <sub>REG</sub>	V <sub>CC</sub> = 15 V, I <sub>O</sub> = 30 mA	5	6	7	V
Speed control voltage range	V <sub>S</sub>	—	0	—	6.5	V
FG output saturation voltage	V <sub>FGsat</sub>	V <sub>CC</sub> = 15 V, I <sub>FG</sub> = 20 mA	—	—	0.5	V
Current control voltage	V <sub>R</sub>	—	0.46	0.5	0.54	V
Thermal shutdown temperature	TSD	—	135	—	185	°C
Thermal shutdown hysteresis	ΔTSD	—	—	50	—	°C
V <sub>CC</sub> under voltage protection	V <sub>CCUVD</sub>	—	10	11	12	V
V <sub>CC</sub> under voltage protection recovery	V <sub>CCUVR</sub>	—	10.5	11.5	12.5	V
V <sub>BS</sub> under voltage protection	V <sub>BSUVD</sub>	—	9	10	11	V
V <sub>BS</sub> under voltage protection recovery	V <sub>BSUVR</sub>	—	9.5	10.5	11.5	V
Refresh operating ON voltage	T <sub>RFON</sub>	Refresh operation	1.1	1.3	1.5	V
Refresh operating OFF voltage	T <sub>RFOFF</sub>	Refresh operation OFF	3.1	3.8	4.6	V
Triangular wave frequency	f <sub>c</sub>	R = 27 kΩ, C = 1000 pF	16.5	20	25	kHz
Output on delay time	t <sub>on</sub>	V <sub>BB</sub> = 280 V, V <sub>CC</sub> = 15 V, I <sub>C</sub> = 0.5 A	—	2.5	3	μs
Output off delay time	t <sub>off</sub>	V <sub>BB</sub> = 280 V, V <sub>CC</sub> = 15 V, I <sub>C</sub> = 0.5 A	—	1.8	3	μs
FRD reverse recovery time	t <sub>rr</sub>	V <sub>BB</sub> = 280 V, V <sub>CC</sub> = 15 V, I <sub>C</sub> = 0.5 A	—	200	—	ns



## Application Circuit Example

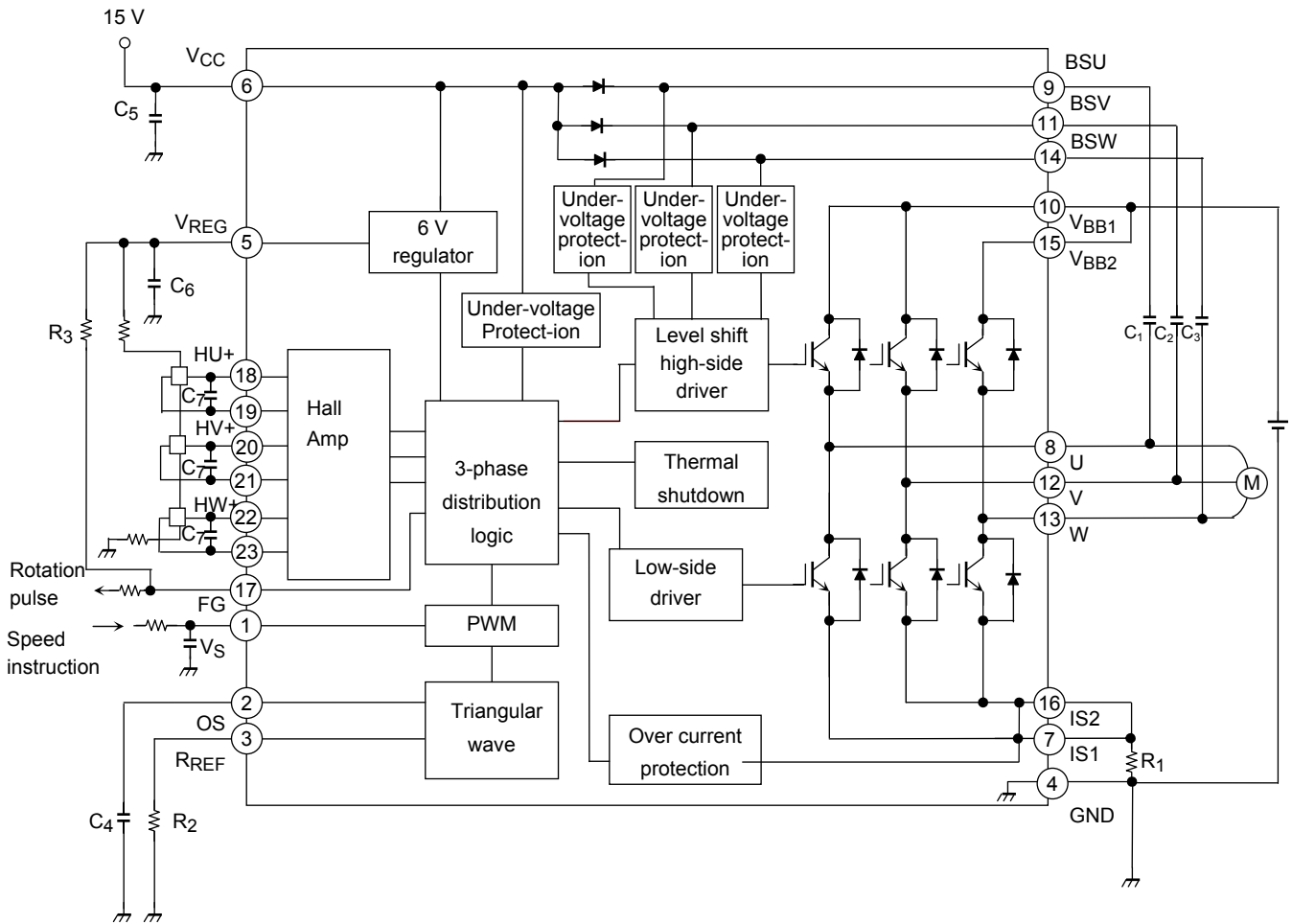

**External Parts**

Standard external parts are shown in the following table.

Part	Recommended Value	Purpose	Remarks
C <sub>1</sub> , C <sub>2</sub> , C <sub>3</sub>	25 V/2.2 μF	Bootstrap capacitor	(Note 1)
R <sub>1</sub>	0.62 Ω ± 1% (1 W)	Current detection	(Note 2)
C <sub>4</sub>	10 V/1000 pF ± 5%	PWM frequency setup	(Note 3)
R <sub>2</sub>	27 kΩ ± 5%	PWM frequency setup	(Note 3)
C <sub>5</sub>	25 V/10 μF	Control power supply stability	(Note 4)
C <sub>6</sub>	10 V/0.1 μF	V <sub>REG</sub> power supply stability	(Note 4)
R <sub>3</sub>	5.1 kΩ	FG pin pull-up resistor	(Note 5)
C <sub>7</sub>	TBD	Input power supply stability	(Note 6)

Note 1: The required bootstrap capacitance value varies according to the motor drive conditions. The IC can operate at above the V<sub>BS</sub> undervoltage level, however, it is recommended that the capacitor voltage be greater than or equal to 13.5 V to keep the power dissipation small. The capacitor is biased by V<sub>CC</sub> and must be sufficiently derated for it.

Note 2: The following formula shows the detection current: I<sub>O</sub> = V<sub>R</sub> ÷ R<sub>IS</sub> (V<sub>R</sub> = 0.5 V typ.)  
Do not exceed a detection current of 1 A when using the IC.

Note 3: With the combination of C<sub>os</sub> and R<sub>REF</sub> shown in the table, the PWM frequency is around 20 kHz. The IC intrinsic error factor is around 10%.

The PWM frequency is broadly expressed by the following formula. (In this case, the stray capacitance of the printed circuit board needs to be considered.)

$$f_{PWM} = 0.65 \div \{C_{os} \times (R_{REF} + 4.25 \text{ k}\Omega)\} \quad [\text{Hz}]$$

R<sub>REF</sub> creates the reference current of the PWM triangular wave charge/discharge circuit. If R<sub>REF</sub> is set too small it exceeds the current capacity of the IC internal circuits and the triangular wave distorts. Set R<sub>REF</sub> to at least 9 kΩ.

Note 4: When using the IC, some adjustment is required in accordance with the use environment. When mounting, place as close to the base of the IC leads as possible to improve the noise elimination.

Note 5: The FG pin is open drain. Note that when the FG pin is connected to a power supply with a voltage higher than or equal to the V<sub>CC</sub>, a protection circuit is triggered so that the current flows continuously. If not using the FG pin, connect to the GND.

Note 6: If noise is detected on the Input signal pin, add a capacitor between inputs.

**Handling precautions**

- (1) When switching the power supply to the circuit on/off, ensure that V<sub>S</sub> < V<sub>VSOFF</sub> (all IGBT outputs off). At that time, either the V<sub>CC</sub> or the V<sub>BB</sub> can be turned on/off first. Note that if the power supply is switched off as described above, the IC may be destroyed if the current regeneration route to the V<sub>BB</sub> power supply is blocked when the V<sub>BB</sub> line is disconnected by a relay or similar while the motor is still running.
- (2) The triangular wave oscillator circuit, with externally connected C<sub>OS</sub> and R<sub>REF</sub>, charges and discharges minute amounts of current. Therefore, subjecting the IC to noise when mounting it on the board may distort the triangular wave or cause malfunction. To avoid this, attach external parts to the base of the IC leads or isolate them from any tracks or wiring which carries large current.
- (3) The PWM of this IC is controlled by the on/off state of the high-side IGBT.
- (4) In the state where V<sub>BB</sub> voltage is low, and Duty100%, if a motor is made to lock, after load release may be unable to reboot. This is the high side ON of a just before lock, when a motor is locked in the state where V<sub>BB</sub> voltage is low. It is because time becomes long, bootstrap voltage falls, the decrease voltage protection of a high side operates and a high side output serves as OFF. In this case, since the level shift pulse for making a high side turn on is ungenerable, it cannot reboot. A level shift pulse is generated from the edge of a hole sensor output and the edge of a hall sensor output edge of an internal PWM signal, neither of the edge exists by the motor lock and Duty100% command. In order to reboot after lock, it is required for a high side input signal to enter in the state where it recovered to voltage with high side power supply voltage higher 0.5v than a decrease voltage protection voltage value. Since a high side input signal is created by the above-mentioned level shift pulse, it can reboot

by making Duty of PWM less than 100%, or turning a motor from the outside compulsorily, and creating edge to a hall sensor output. In order to enable the reboot after a lock as a system, it is necessary to restrict and obtain on motor specification so that the maximum of Duty may become less than 100%.

## Description of Protection Function

### (1) Over current protection

The IC incorporates the over current protection circuit to protect itself against over current at startup or when a motor is locked. This protection function detects voltage generated in the current detection resistor connected to the IS pin. When this voltage exceeds  $V_R = 0.5 \text{ V}$  (typ.), the high-side IGBT output, which is on, temporarily shuts down after a mask period, preventing any additional current from flowing to the IC. The next PWM ON signal releases the shutdown state.

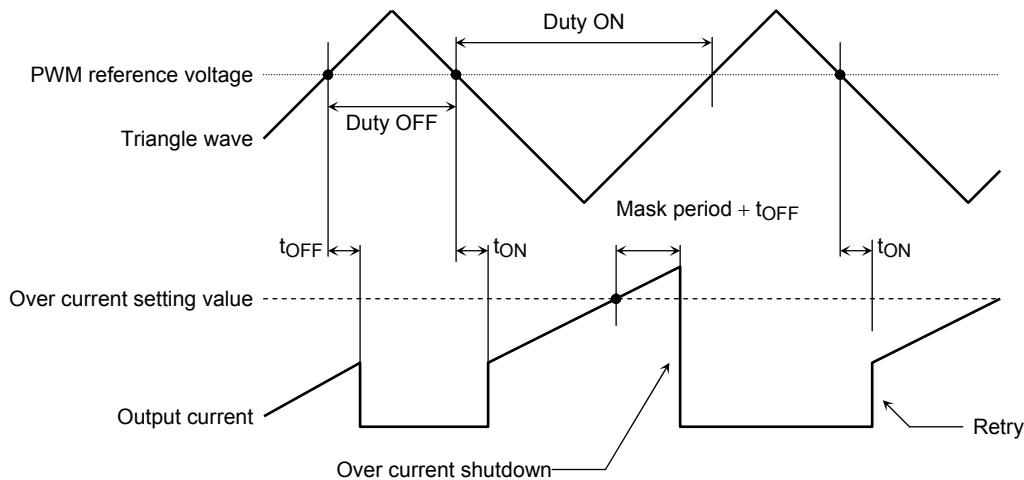

### (2) Under voltage protection

The IC incorporates the under voltage protection circuit to prevent the IGBT from operating in unsaturated mode when the  $V_{CC}$  voltage or the  $V_{BS}$  voltage drops.

When the  $V_{CC}$  power supply falls to the IC internal setting ( $V_{CCUVD} = 11 \text{ V}$  typ.), all IGBT outputs shut down regardless of the input. This protection function has hysteresis. When the  $V_{CCUVR}$  ( $= 11.5 \text{ V}$  typ.) reaches  $0.5 \text{ V}$  higher than the shutdown voltage, the IC is automatically restored and the IGBT is turned on again by the input.

When the  $V_{BS}$  supply voltage drops ( $V_{BSUVD} = 10 \text{ V}$  typ.), the high-side IGBT output shuts down. When the  $V_{BSUVR}$  ( $= 10.5 \text{ V}$  typ.) reaches  $0.5 \text{ V}$  higher than the shutdown voltage, the IGBT is turned on again by the input signal.

### (3) Thermal shutdown

The IC incorporates the thermal shutdown circuit to protect itself against the abnormal state when its temperature rises excessively.

When the temperature of this chip rises due to external causes or internal heat generation and the internal setting TSD, all IGBT outputs shut down regardless of the input. This protection function has hysteresis ( $\Delta TSD = 50^\circ\text{C}$  typ.). When the chip temperature falls to  $TSD - \Delta TSD$ , the chip is automatically restored and the IGBT is turned on again by the input.

Because the chip contains just one temperature detection location, when the chip heats up due to the IGBT, for example, the differences in distance from the detection location in the IGBT (the source of the heat) cause differences in the time taken for shutdown to occur. Therefore, the temperature of the chip may rise higher than the thermal shutdown temperature when the circuit started to operate.

**Description of Bootstrap Capacitor Charging and Its Capacitance**

The IC uses bootstrapping for the power supply for high-side drivers. The bootstrap capacitor is charged by turning on the low-side IGBT of the same arm (approximately 1/5 of PWM cycle) while the high-side IGBT controlled by PWM is off. (For example, to drive at 20 kHz, it takes approximately 10 ms per cycle to charge the capacitor.) When the VS voltage exceeds 3.8 V (55% duty), the low-side IGBT is continuously in the off state. This is because when the PWM on-duty becomes larger, the arm is short-circuited while the low-side IGBT is on. Even in this state, because PWM control is being performed on the high-side IGBT, the regenerative current of the diode flows to the low-side FRD of the same arm, and bootstrap capacitor is charged. Note that when the on-duty is 100%, diode regenerative current does not flow; thus, the bootstrap capacitor is not charged.

When driving a motor at 100 % duty cycle, take the voltage drop at 100% duty (see the figure below) into consideration to determine the capacitance of the bootstrap capacitor.

Capacitance of the bootstrap capacitor = Consumption current (max) of the high-side driver × Maximum drive time / (VCC - VF (BSD) + VF (FRD) - 13.5) [F]

VF (BSD) : Bootstrap diode forward voltage

VF (FRD) : Flywheel diode forward voltage

Care must be taken for aging and temperature change of the capacitor.

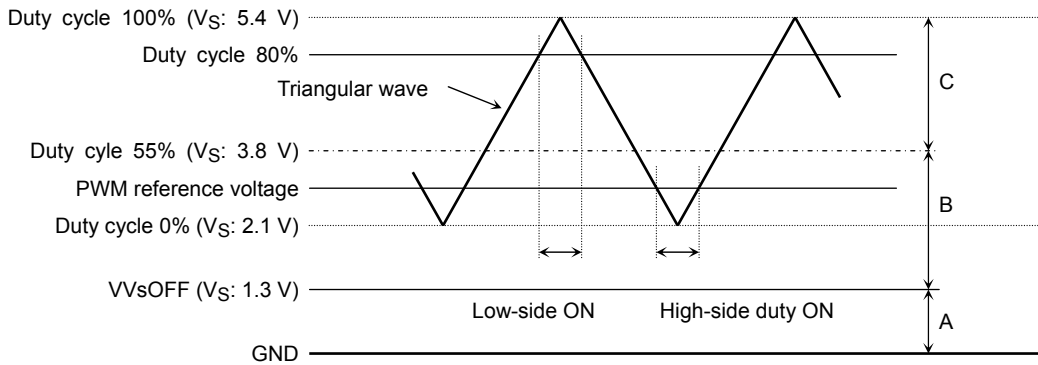

V <sub>S</sub> Range	IGBT Operation
A	Both high- and low-side OFF.
B	Charging range. Low-side IGBT refreshing on the phase the high-side IGBT in PWM.
C	No charging range. High-side at PWM according to the timing chart. low-side no refreshing.

**Safe Operating Area**

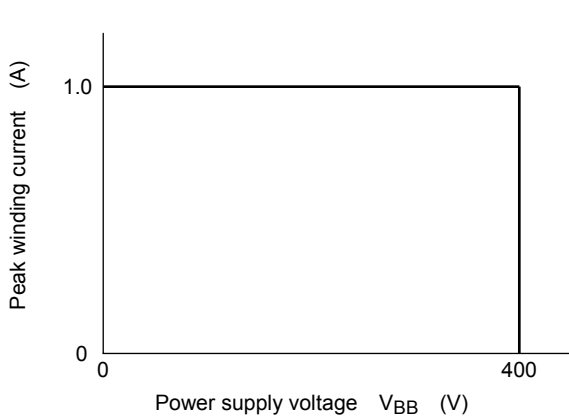

Figure 1 SOA at Tj = 135°C

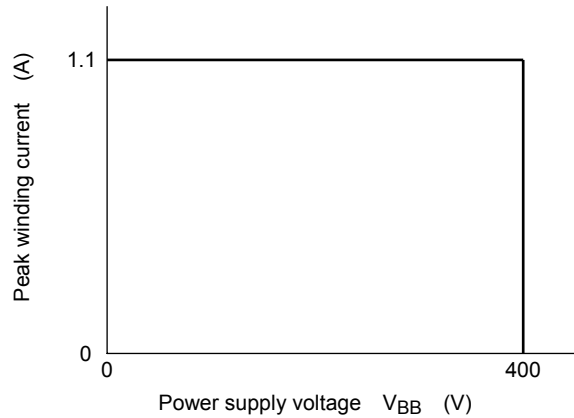
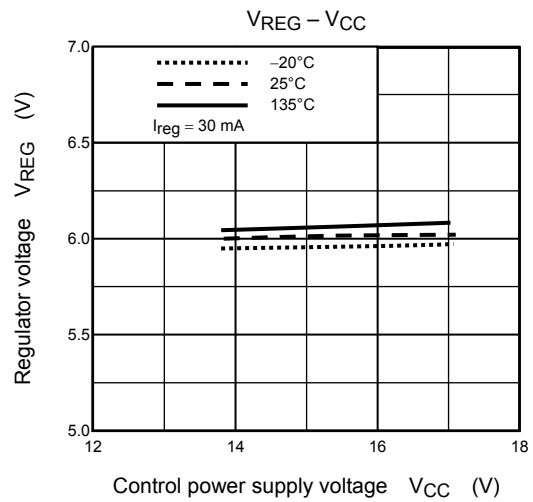
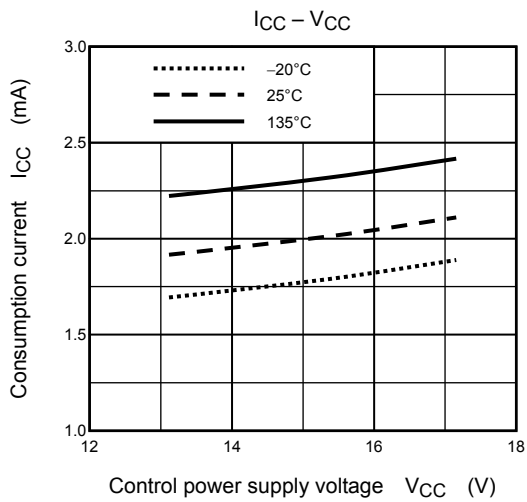
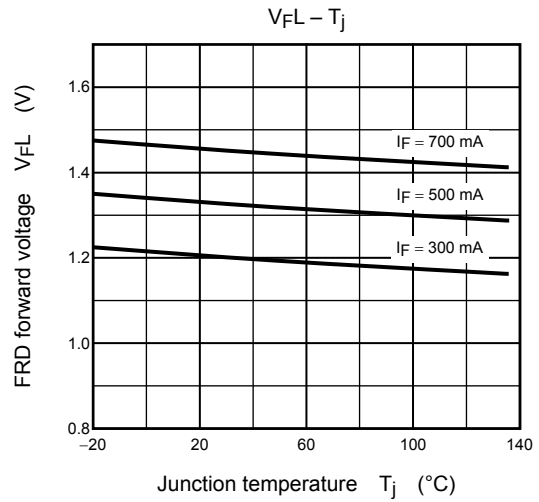
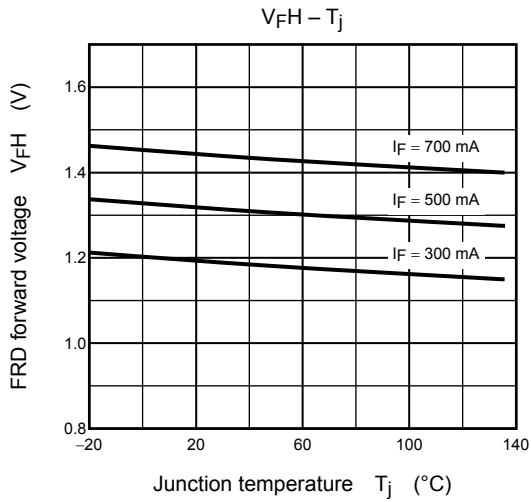
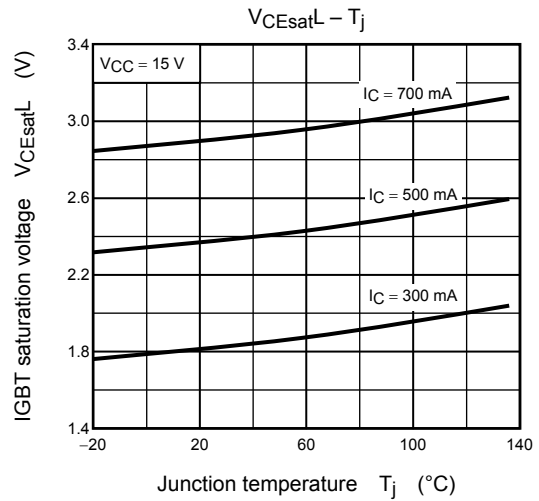
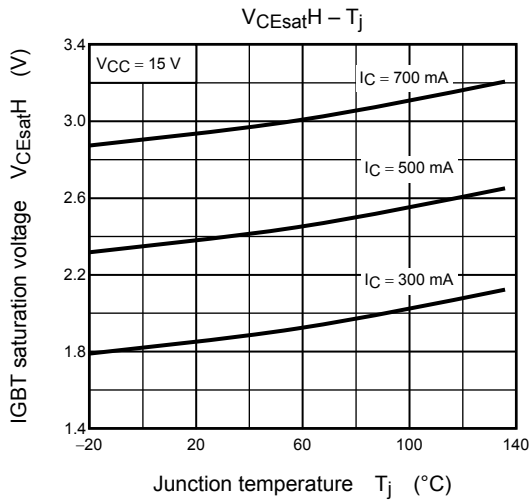
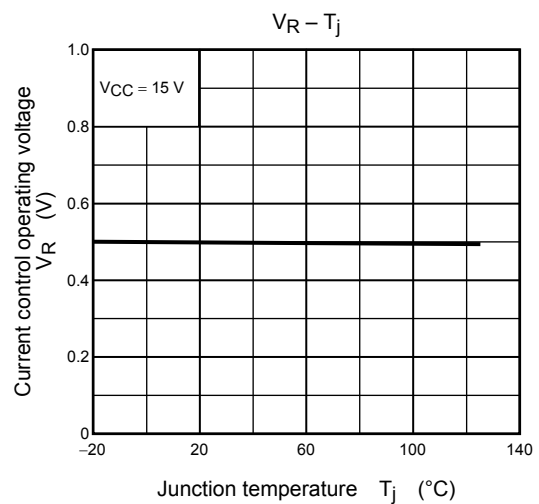
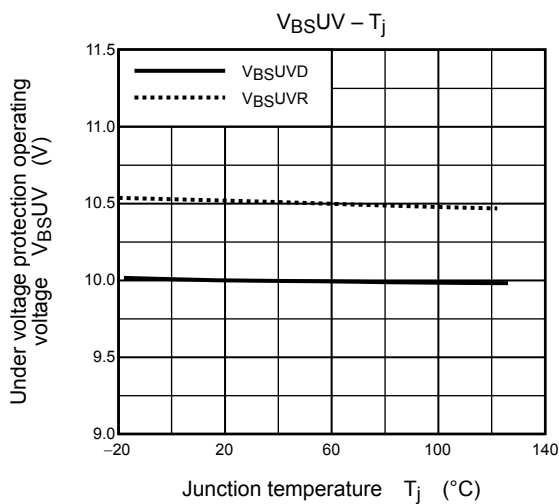
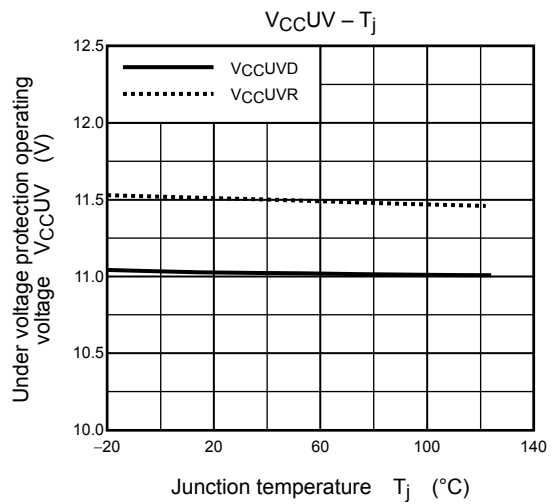
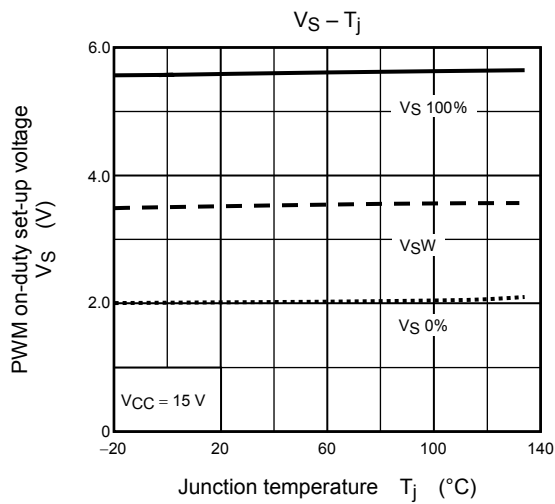
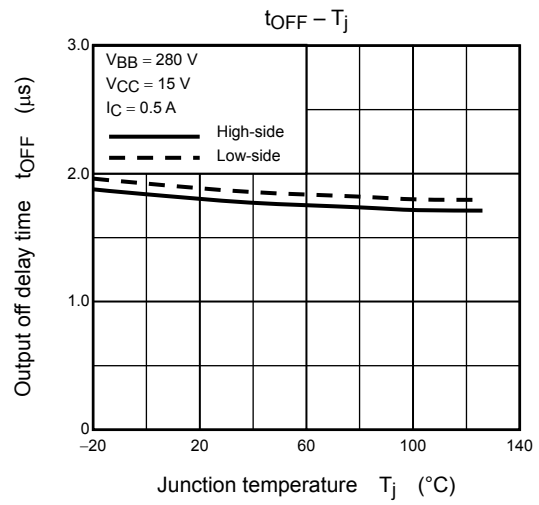
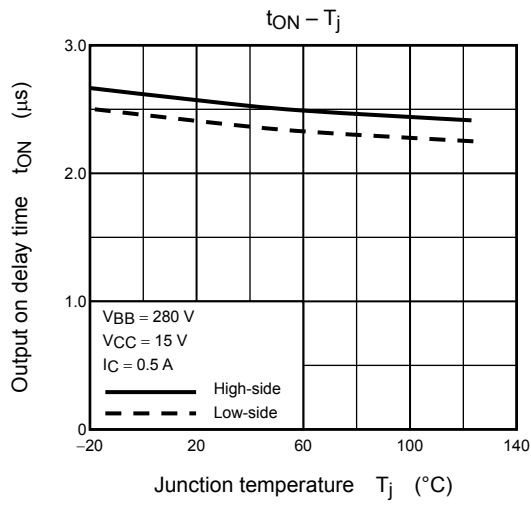

Figure 2 SOA at Tc = 95°C

Note 1: The above safe operating areas are Tj = 135°C (Figure 1) and Tc = 95°C (Figure 2). If the temperature exceeds these, the safe operation areas reduce.

Note 2: The above safe operating areas include the over current protection operation area.





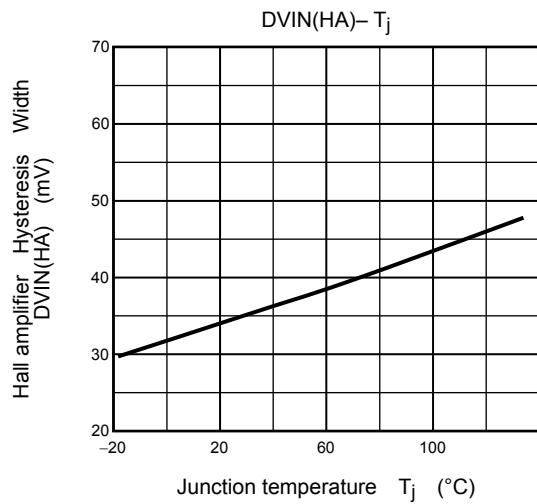
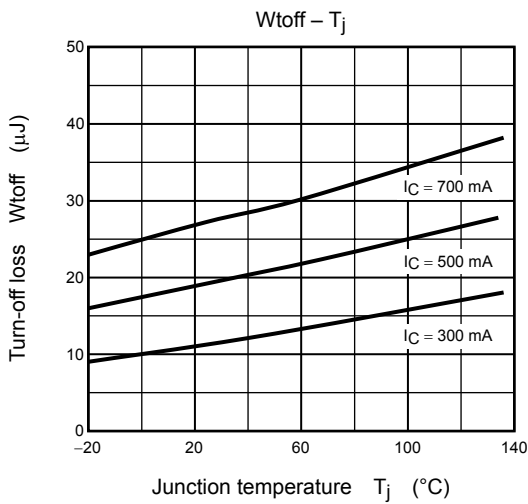
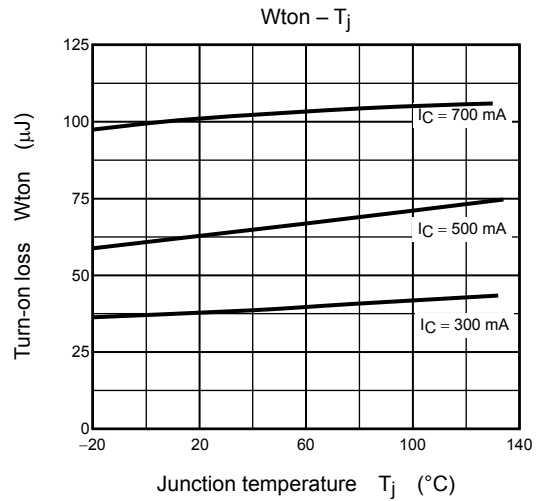
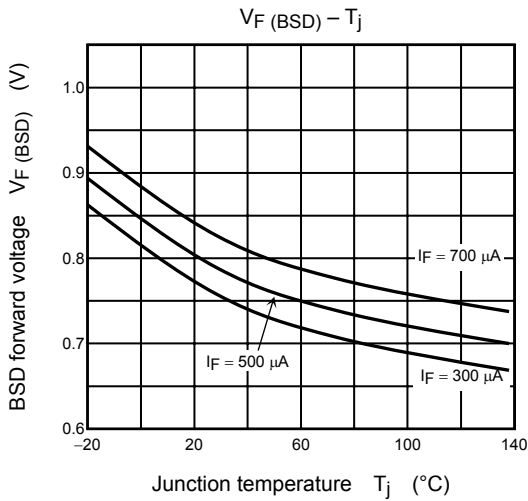
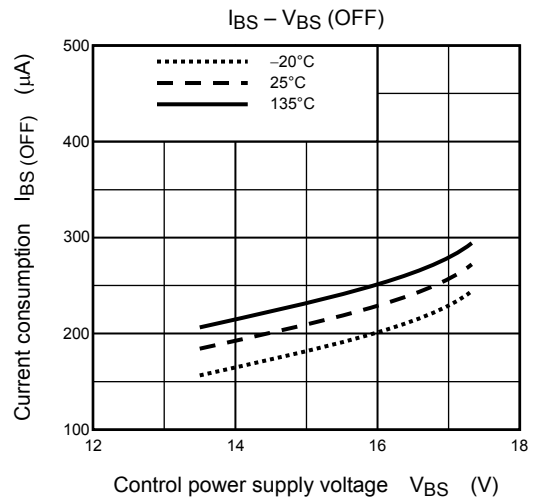
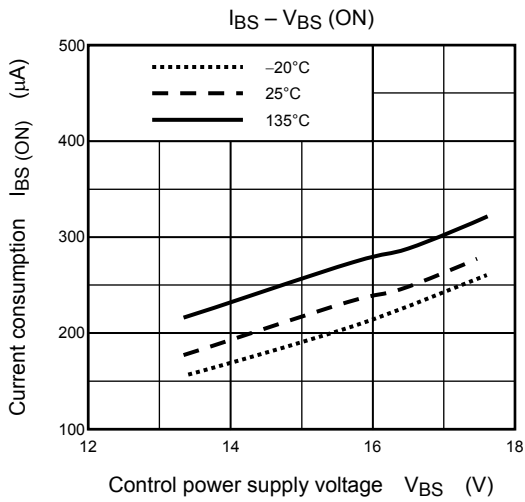

**Test Circuits**

**IGBT Saturation Voltage (U-phase low side)**

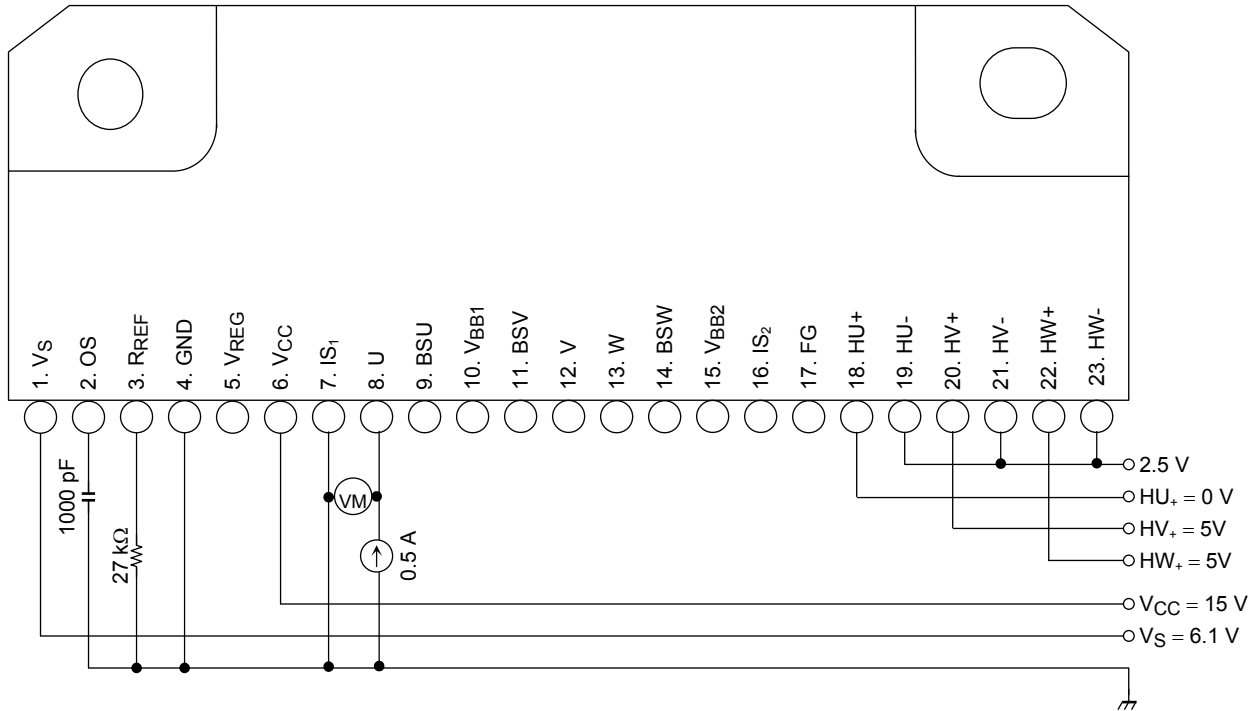

**FRD Forward Voltage (U-phase low side)**

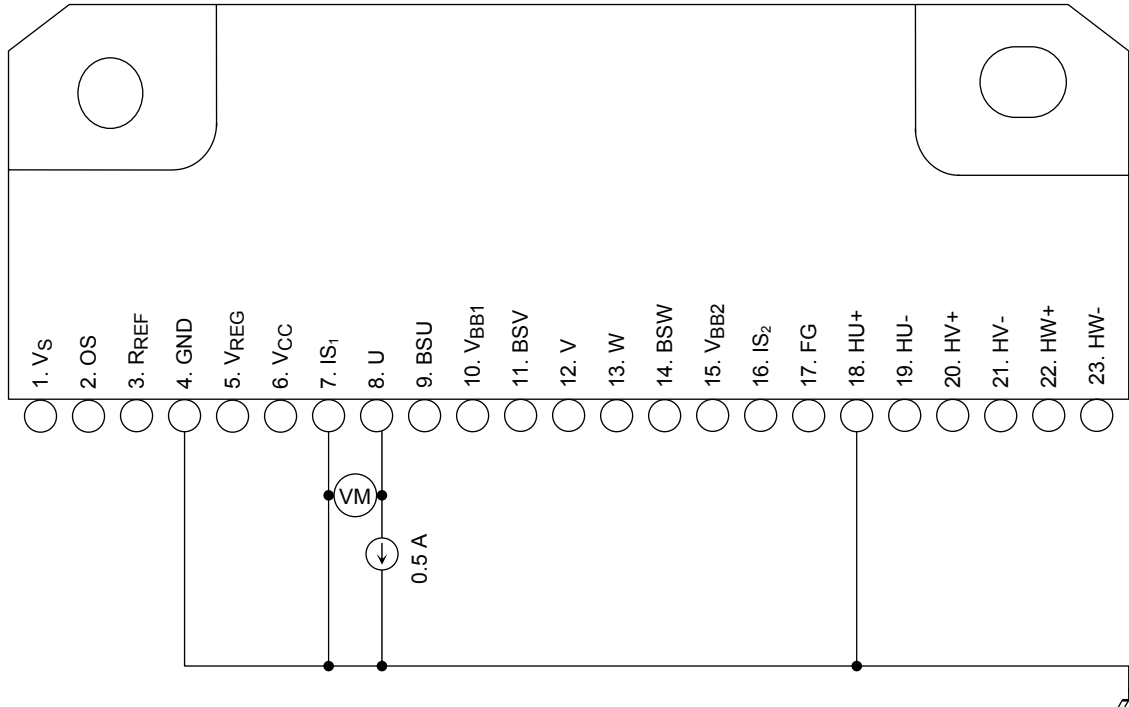



**V<sub>CC</sub> Current Dissipation**

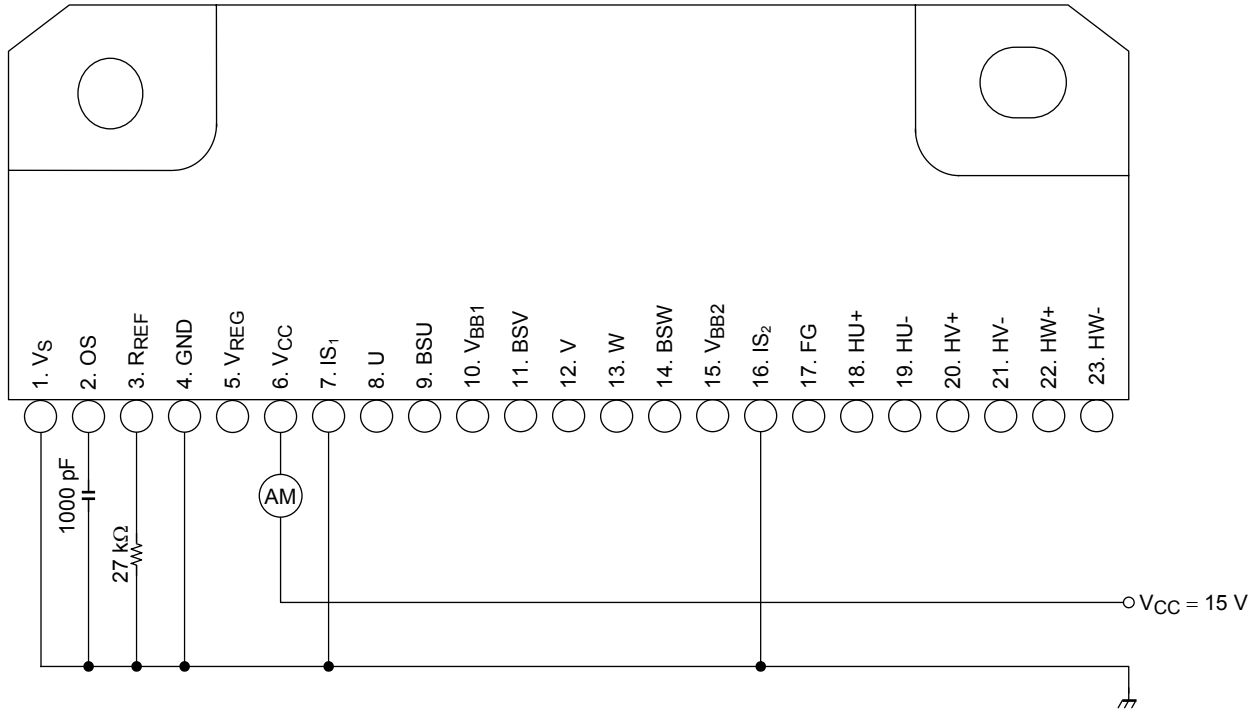

**Regulator Voltage**

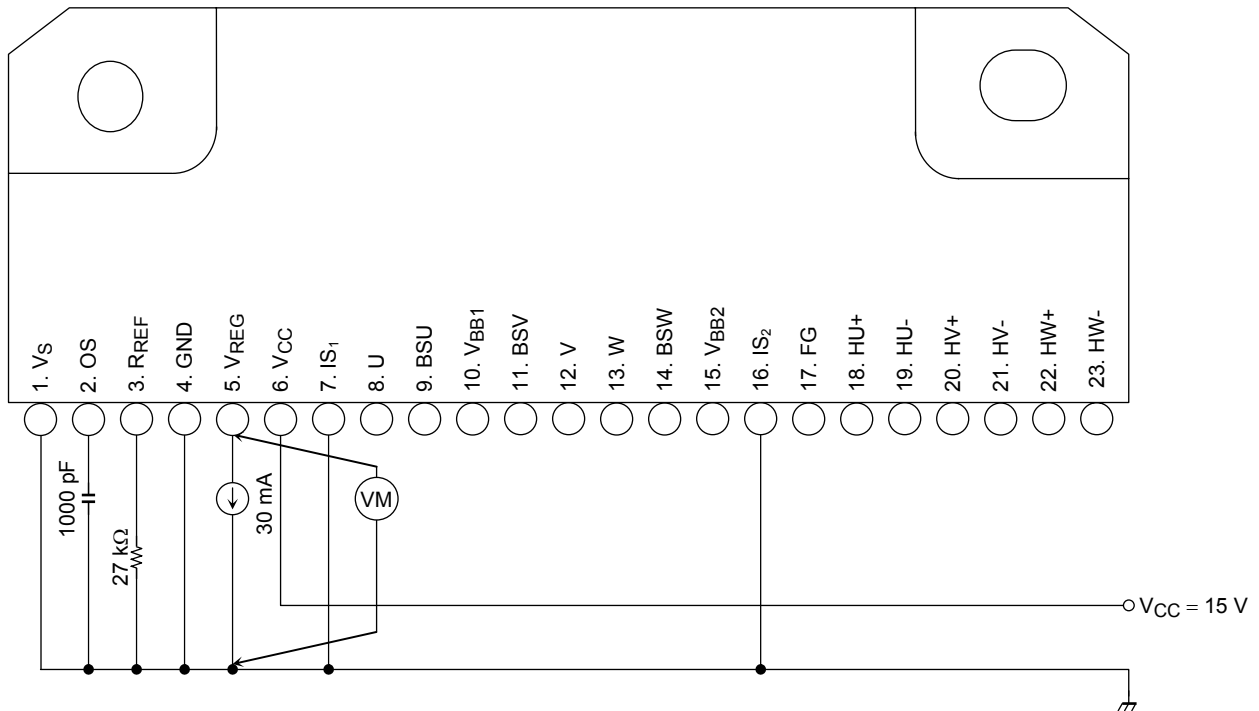

Output ON/OFF Delay Time (U-phase low side)

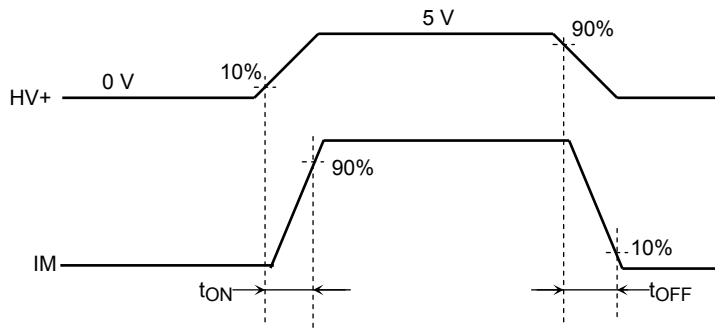
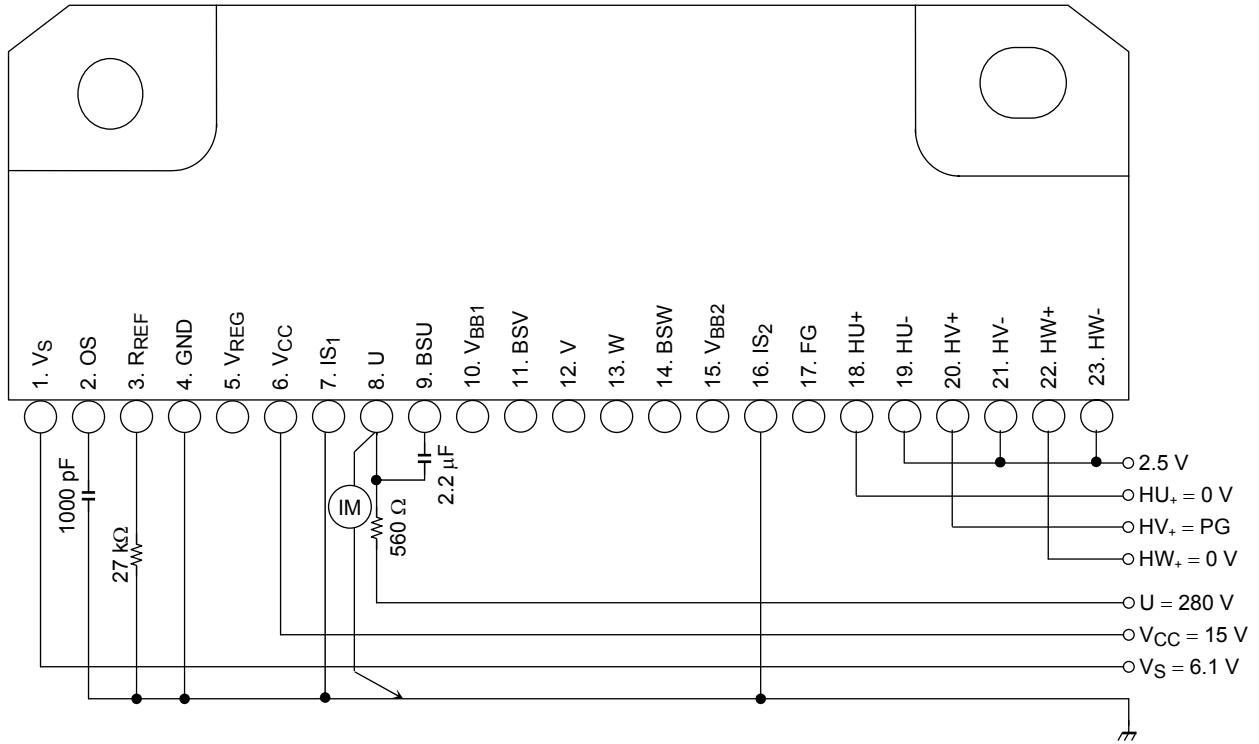

**PWM ON-duty Setup Voltage (U-phase high side)**

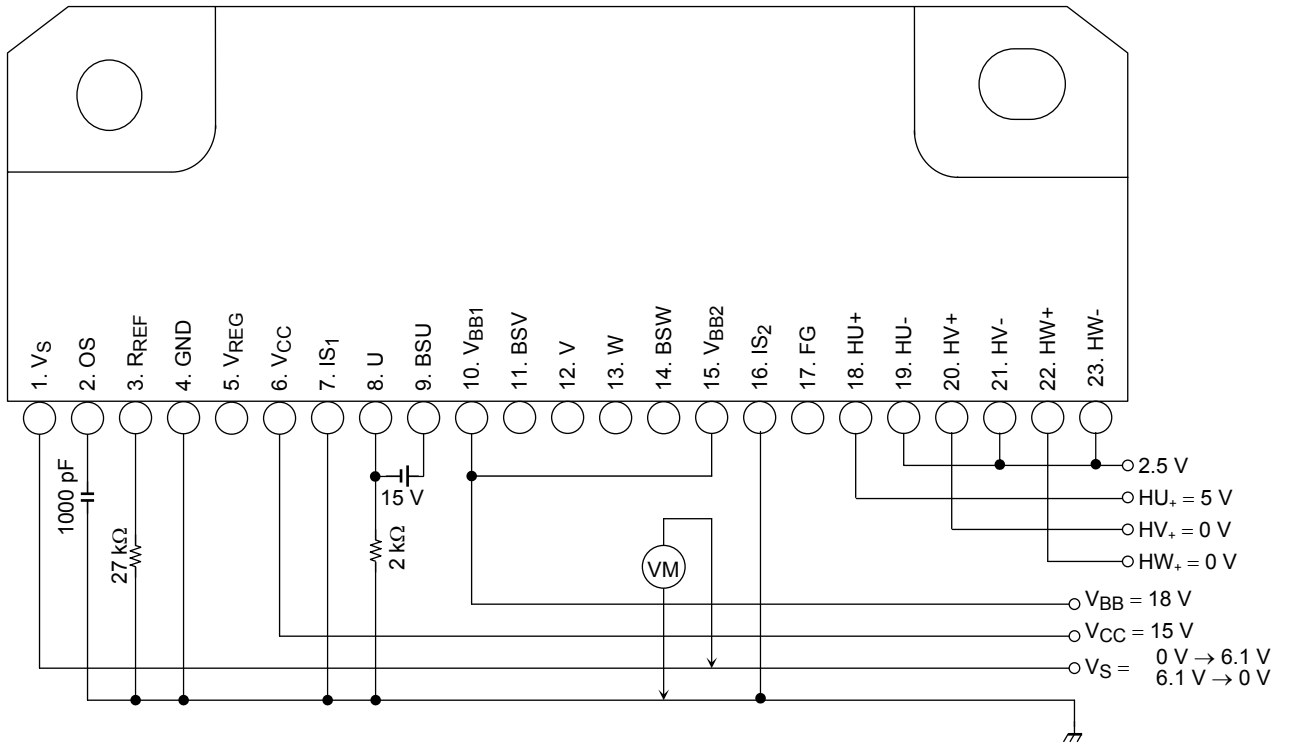

Note: Sweeps the VS pin voltage to increase and monitors the U pin.  
 When output is turned off from on, the PWM = 0%. When output is full on, the PWM = 100%.

**VCC Under voltage Protection Operation/Recovery Voltage (U-phase low side)**

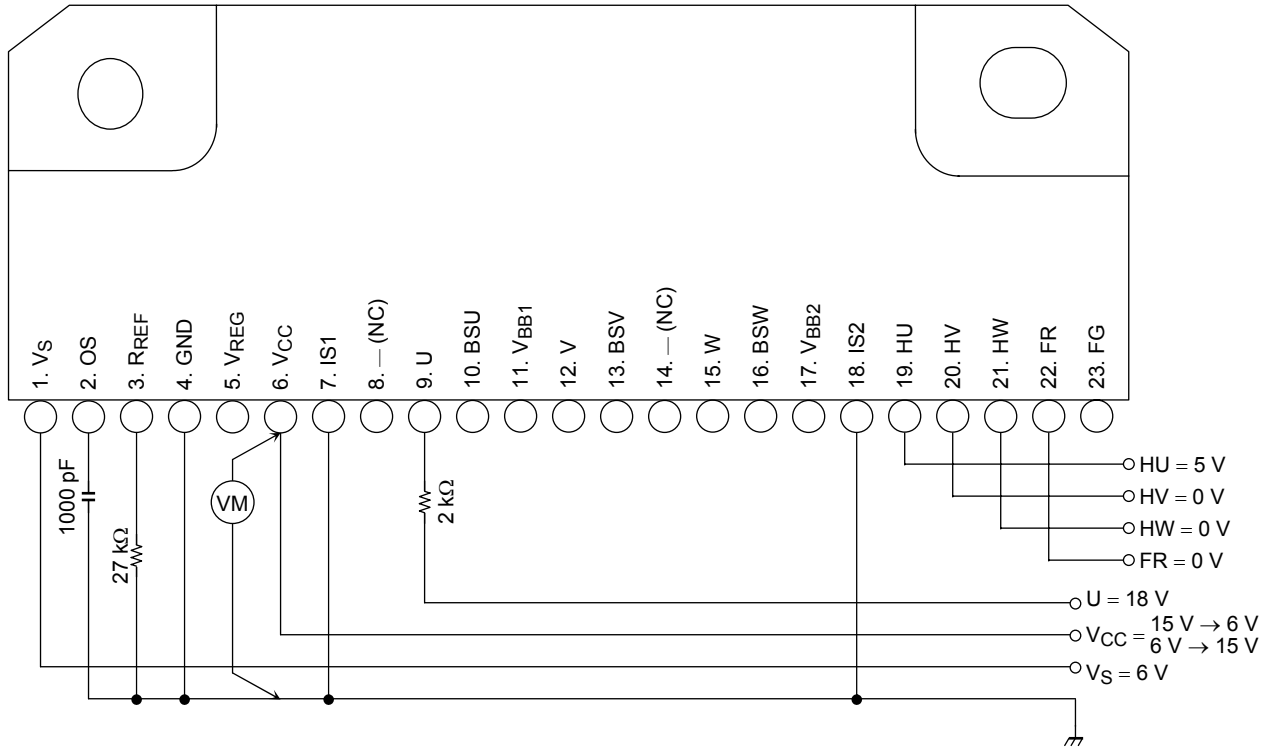

Note: Sweeps the VCC pin voltage from 15 V to decrease and monitors the U pin voltage. The VCC pin voltage when output is off defines the under voltage protection operating voltage. Also sweeps from 6 V to increase. The VCC pin voltage when output is on defines the under voltage protection recovery voltage.

**VBS Under voltage Protection Operation/Recovery Voltage (U-phase high side)**

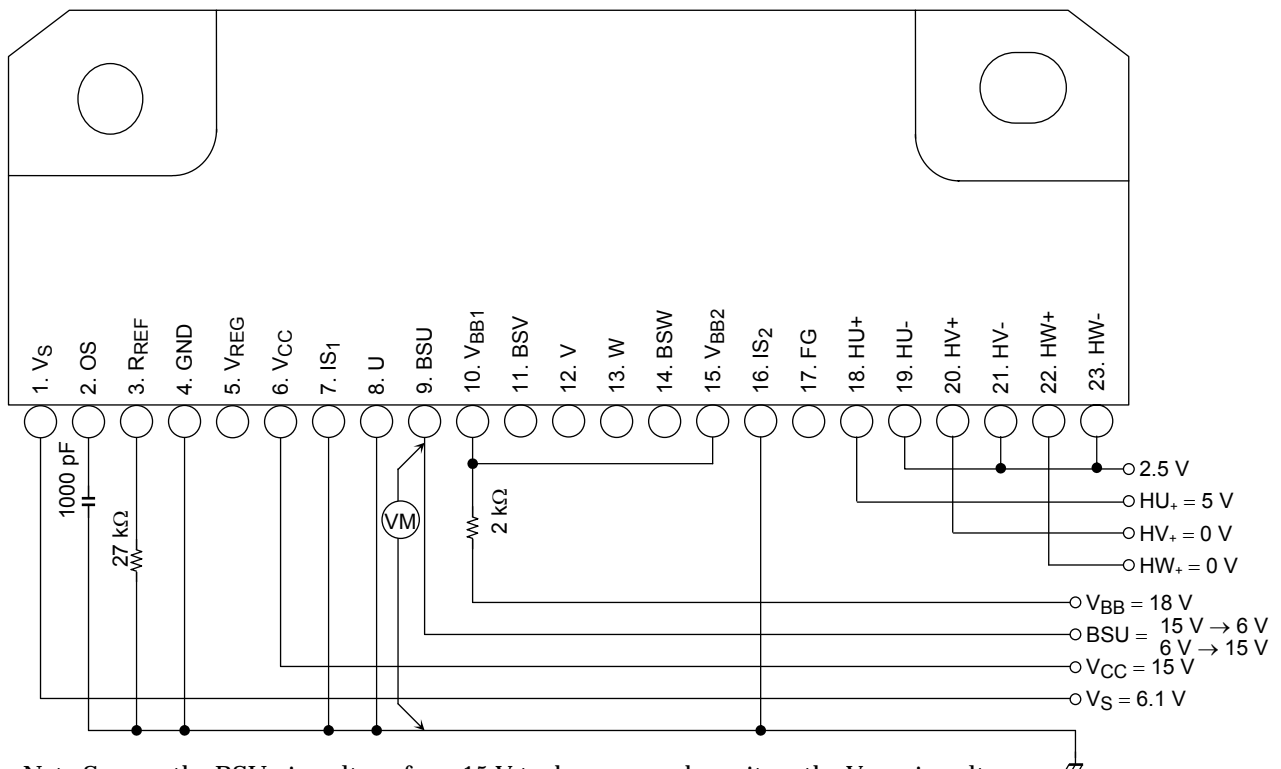

Note: Sweeps the BSU pin voltage from 15 V to decrease and monitors the VBB pin voltage. The BSU pin voltage when output is off defines the under voltage protection operating voltage. Also sweeps the BSU pin voltage from 6 V to increase and change the VS voltage at 6 V → 0 V → 6V. The BSU pin voltage when output is on defines the under voltage protection recovery voltage.

**Current Control Operating Voltage (U-phase high side)**

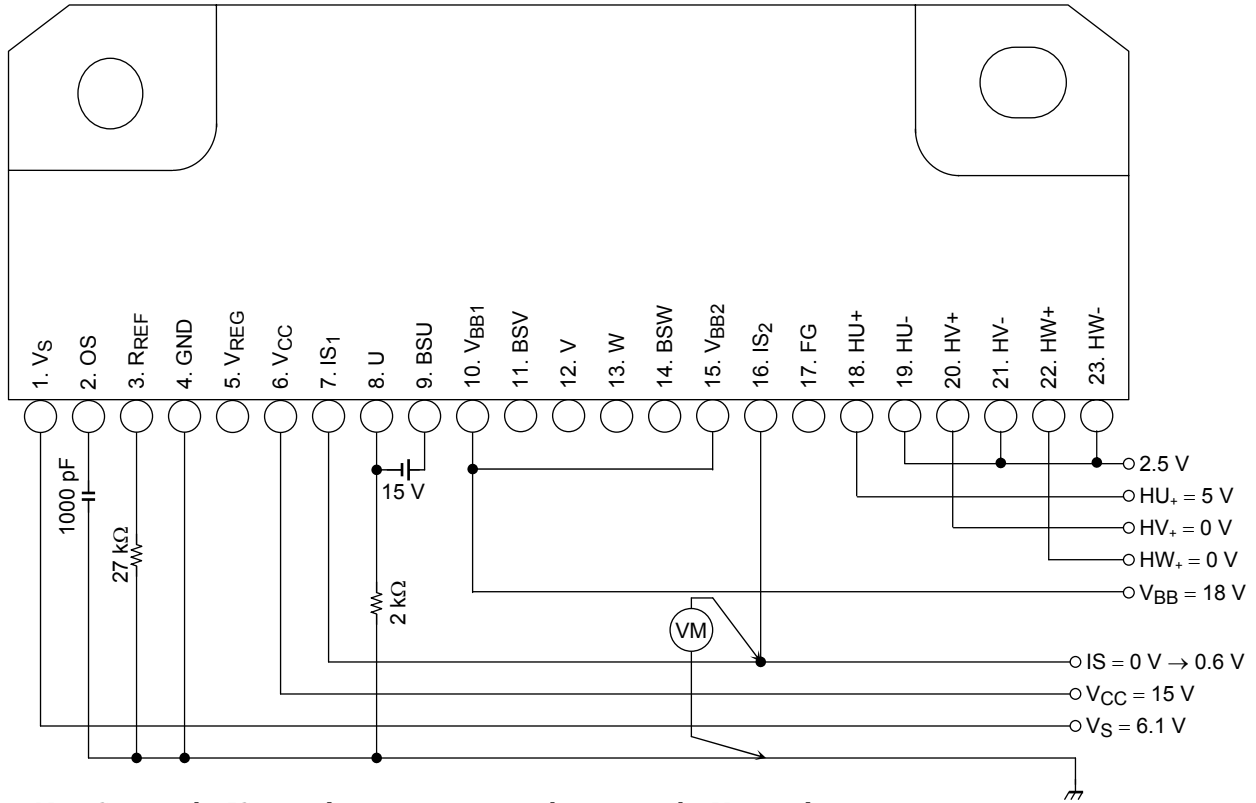

Note: Sweeps the IS pin voltage to increase and monitors the U pin voltage.  
 The IS pin voltage when output is off defines the current control operating voltage.

**V<sub>BS</sub> Current Consumption (U-phase high side)**

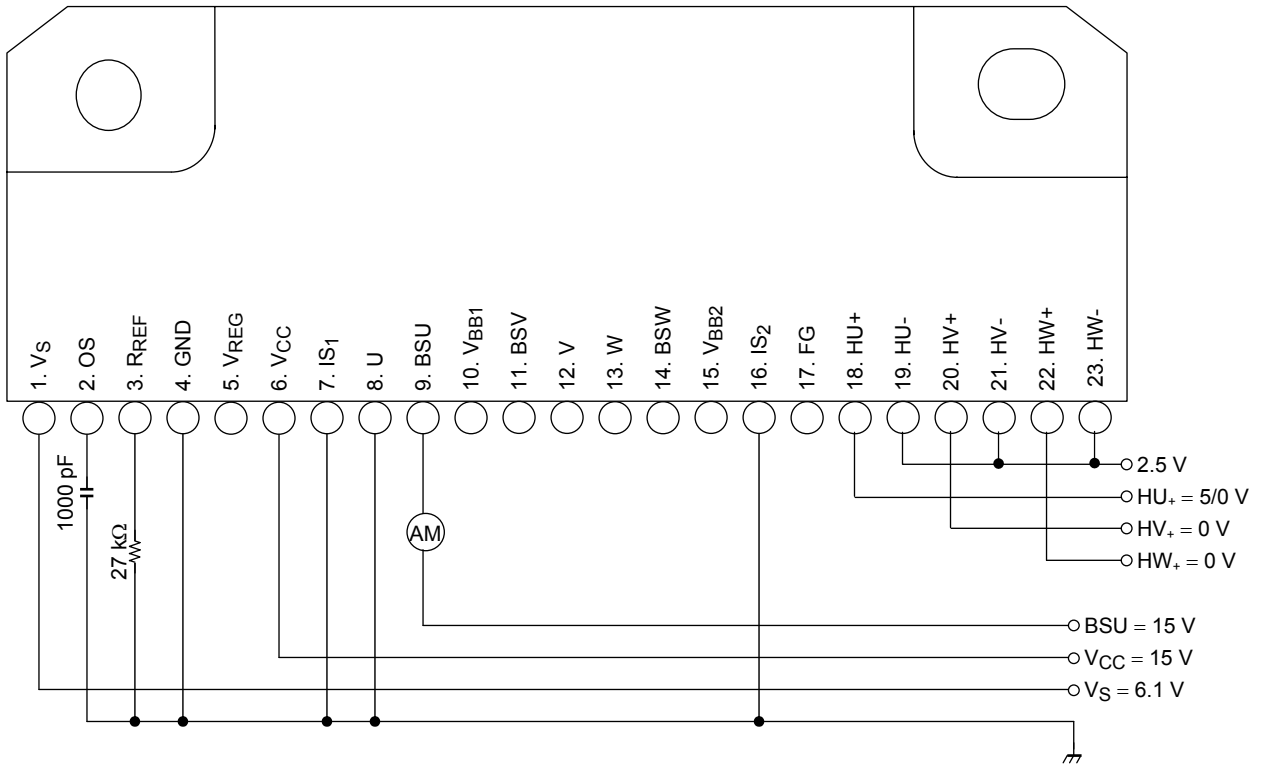

**BSD Forward Voltage (U-phase)**

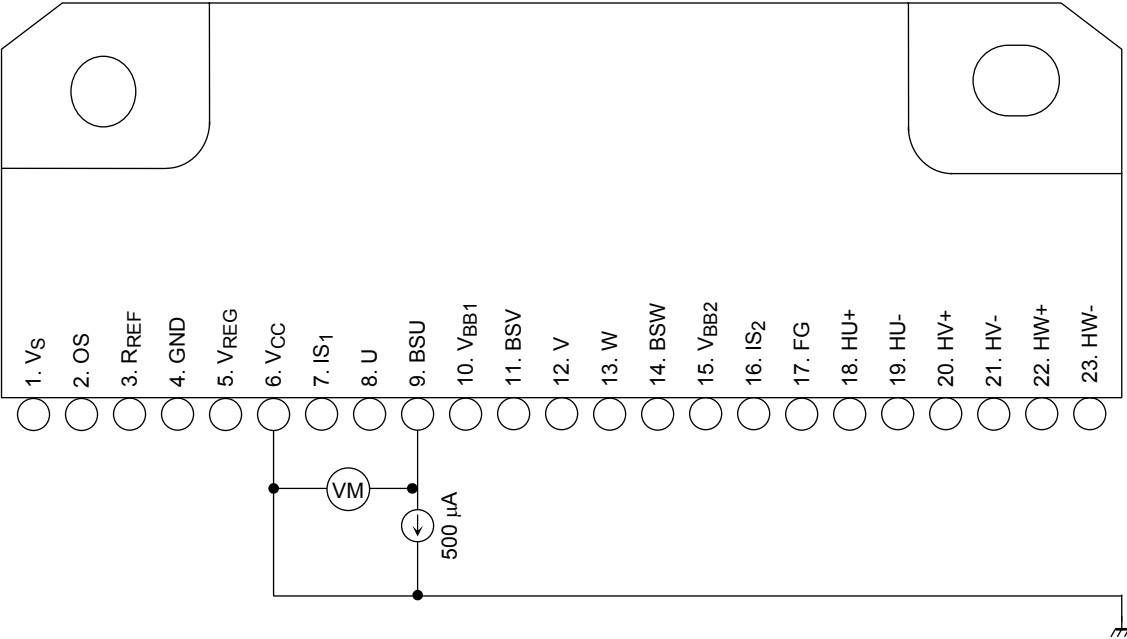

**Turn-On/Off Loss (low-side IGBT + high-side FRD)**

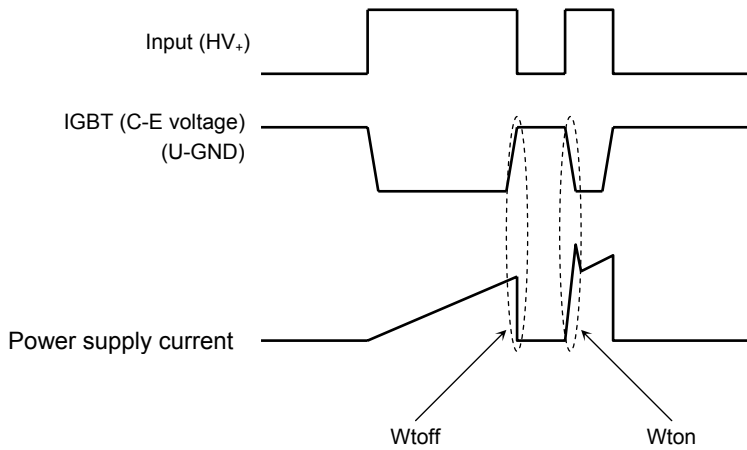
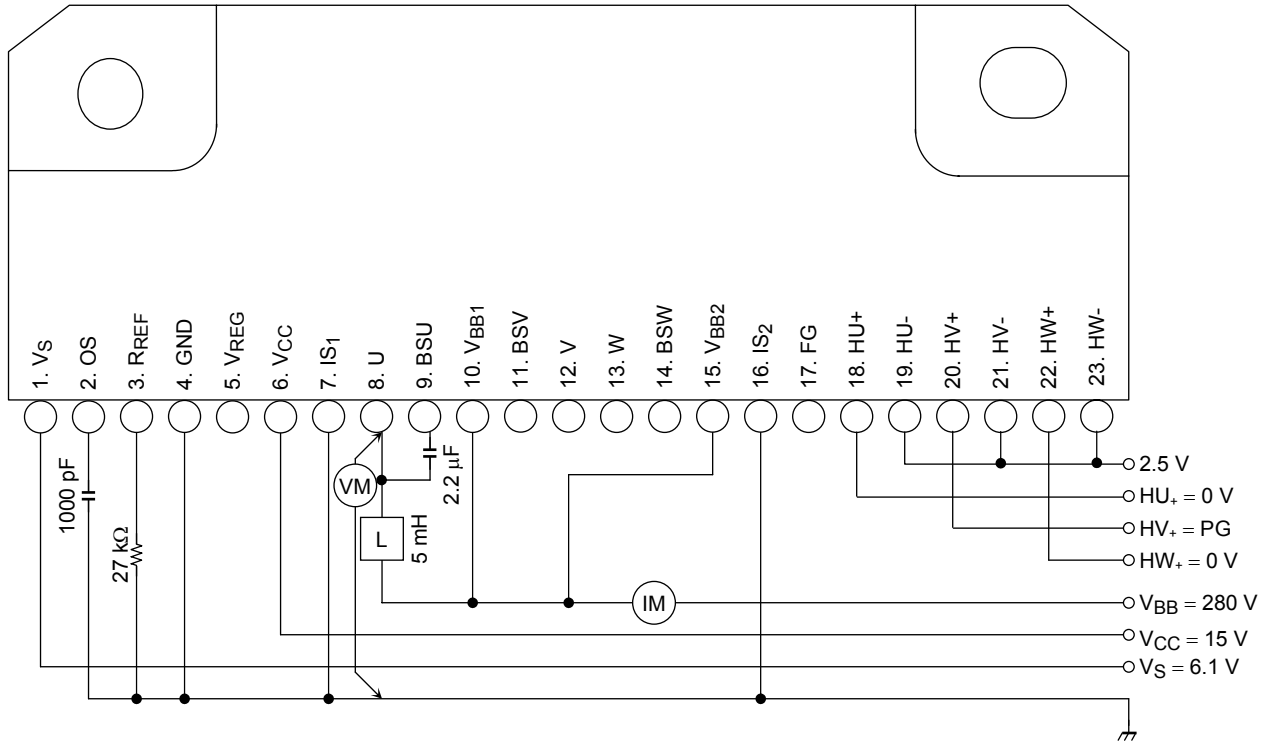



## Package Dimensions

HZIP23-P-1.27F

Unit: mm

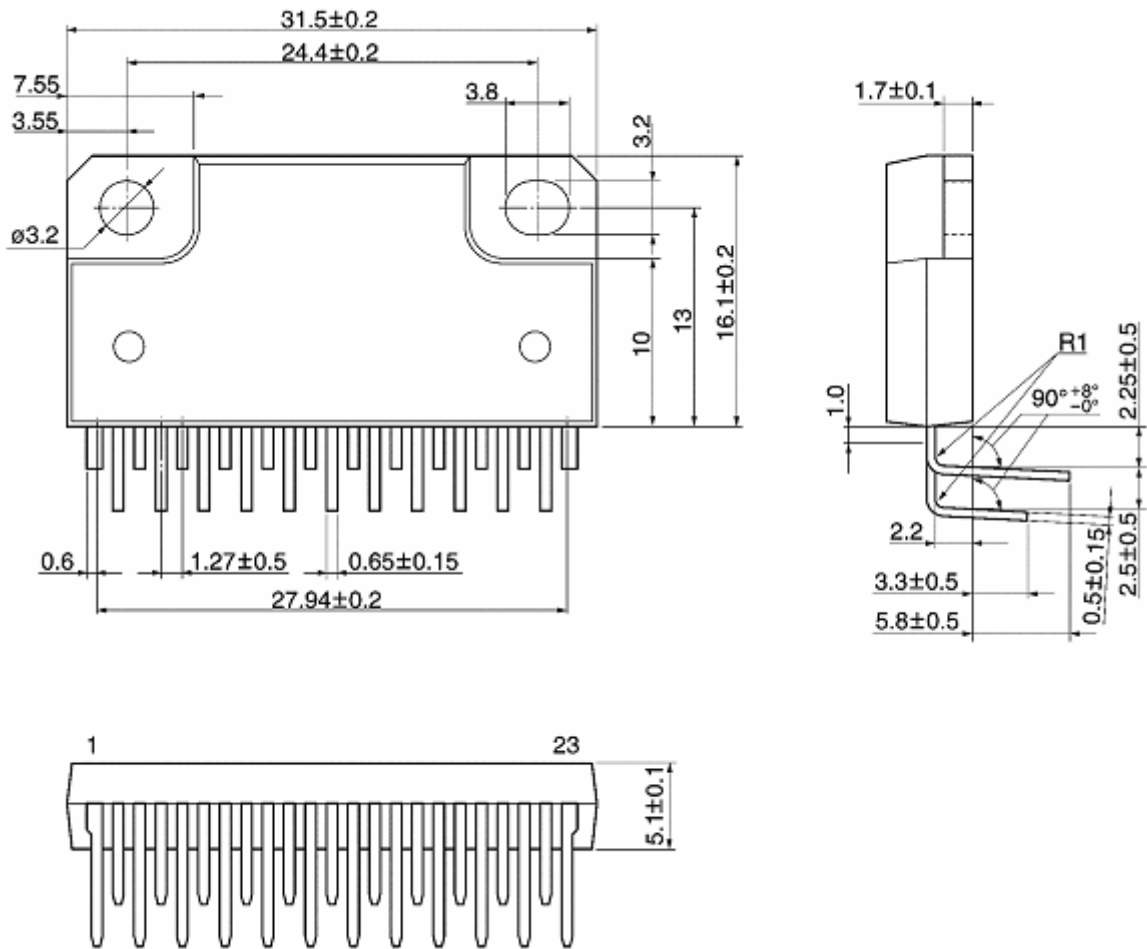

Weight: 6.1 g (typ.)



**Package Dimensions**

HZIP23-P-1.27H

Unit: mm

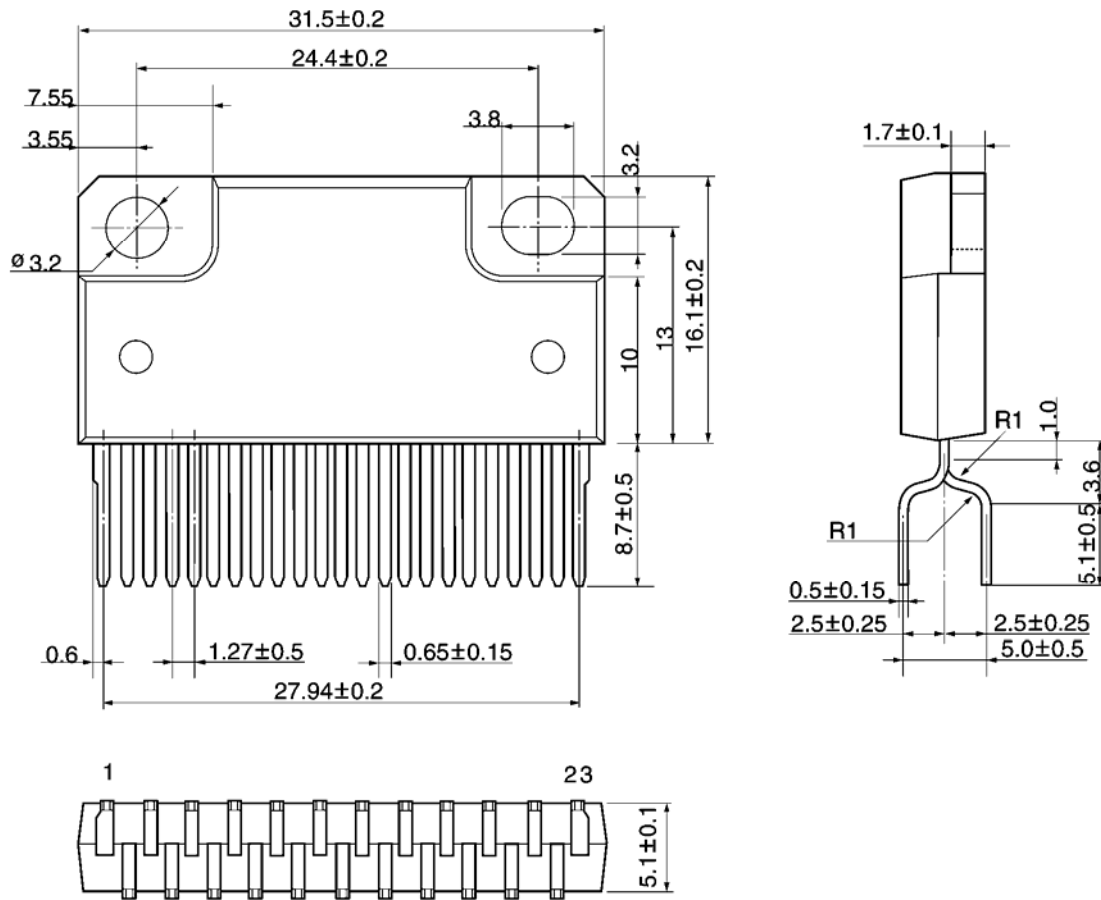

Weight: 6.1 g (typ.)

**RESTRICTIONS ON PRODUCT USE**

000707EBA

- TOSHIBA is continually working to improve the quality and reliability of its products. Nevertheless, semiconductor devices in general can malfunction or fail due to their inherent electrical sensitivity and vulnerability to physical stress. It is the responsibility of the buyer, when utilizing TOSHIBA products, to comply with the standards of safety in making a safe design for the entire system, and to avoid situations in which a malfunction or failure of such TOSHIBA products could cause loss of human life, bodily injury or damage to property.  
In developing your designs, please ensure that TOSHIBA products are used within specified operating ranges as set forth in the most recent TOSHIBA products specifications. Also, please keep in mind the precautions and conditions set forth in the "Handling Guide for Semiconductor Devices," or "TOSHIBA Semiconductor Reliability Handbook" etc..
- The TOSHIBA products listed in this document are intended for usage in general electronics applications (computer, personal equipment, office equipment, measuring equipment, industrial robotics, domestic appliances, etc.). These TOSHIBA products are neither intended nor warranted for usage in equipment that requires extraordinarily high quality and/or reliability or a malfunction or failure of which may cause loss of human life or bodily injury ("Unintended Usage"). Unintended Usage include atomic energy control instruments, airplane or spaceship instruments, transportation instruments, traffic signal instruments, combustion control instruments, medical instruments, all types of safety devices, etc.. Unintended Usage of TOSHIBA products listed in this document shall be made at the customer's own risk.
- The products described in this document are subject to the foreign exchange and foreign trade laws.
- The information contained herein is presented only as a guide for the applications of our products. No responsibility is assumed by TOSHIBA CORPORATION for any infringements of intellectual property or other rights of the third parties which may result from its use. No license is granted by implication or otherwise under any intellectual property or other rights of TOSHIBA CORPORATION or others.
- The information contained herein is subject to change without notice.