

# TPS2202, TPS2202Y DUAL-SLOT PC CARD POWER-INTERFACE SWITCHES FOR SERIAL PCMCIA CONTROLLERS

SLVS103A – DECEMBER 1994 – REVISED AUGUST 1995

- Fully Integrated  $V_{CC}$  and  $V_{pp}$  Switching for Dual-Slot PC Card Interface
- Saves PCMCIA Controller I/O Leads by Utilizing 3-Lead Serial Interface
- Meets PCMCIA Standards
- Internal Charge Pump (No External Capacitors Required) – 12-V Supply Can Be Disabled Except for Flash Programming
- Short Circuit and Thermal Protection
- Space-Saving 30-Pin SSOP(DB) Package
- Compatible With 3.3-V, 5-V and 12-V PC Cards
- Power Saving  $I_{DD} = 83 \mu A$  Typ,  $I_Q = 1 \mu A$
- Low  $r_{DS(on)}$  (160-m $\Omega$   $V_{CC}$  Switch)
- Break-Before-Make Switching
- ESD Protection Up to 2 kV Per Mil-STD-883C, Method 3015

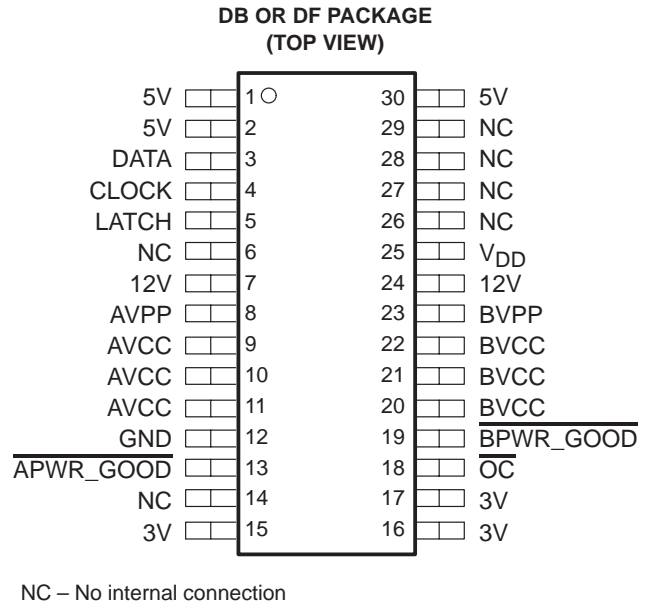

## description

The TPS2202 PC Card (PCMCIA) power-interface switch provides an integrated power-management solution for two PC Cards. All of the discrete power MOSFETs, a logic section, current limiting, thermal protection, and power-good reporting for PC Card control are combined on a single integrated circuit (IC), using Texas Instruments LinBiCMOS™ process. The circuit allows the distribution of 3-V, 5-V, and/or 12-V card power by means of a reduced I/O serial interface. The current-limiting feature eliminates the need for fuses, which reduces component count and improves reliability; current-limit reporting can help the user isolate a system fault to a bad card.

The TPS2202 maximizes battery life by using an internal charge pump to generate its own switch-drive voltage. Therefore, the 12-V supply can be powered down and only brought out of standby when flash memory needs to be written to or erased. End equipment for the TPS2202 includes notebook computers, desktop computers, personal digital assistants (PDAs), digital cameras, handterminals, and bar-code scanners.

## typical PC-card power-distribution application

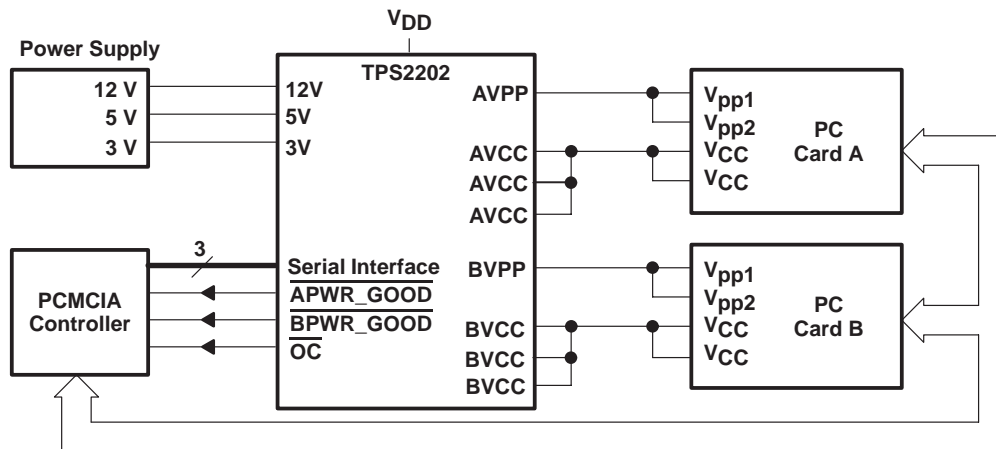

LinBiCMOS is a trademark of Texas Instruments Incorporated.

PRODUCTION DATA information is current as of publication date. Products conform to specifications per the terms of Texas Instruments standard warranty. Production processing does not necessarily include testing of all parameters.



POST OFFICE BOX 655303 • DALLAS, TEXAS 75265

Copyright © 1995, Texas Instruments Incorporated

# TPS2202, TPS2202Y DUAL-SLOT PC CARD POWER-INTERFACE SWITCHES FOR SERIAL PCMCIA CONTROLLERS

SLVS103A – DECEMBER 1994 – REVISED AUGUST 1995

## AVAILABLE OPTIONS

| T <sub>J</sub> | PACKAGED DEVICES         |                    | CHIP FORM (Y) |
|----------------|--------------------------|--------------------|---------------|
|                | SHINK SMALL-OUTLINE (DB) | SMALL-OUTLINE (DF) |               |
| -40°C to 150°C | TPS2202IDB               | TPS2202IDF         | TPS2202Y      |

† The DF package is only available left-end taped and reeled (indicated by the LE suffix on the device type; e.g., TPS2202IDFLE).

## Terminal Functions

| TERMINAL NAME   | NO.                   | I/O | DESCRIPTION                                                                                  |
|-----------------|-----------------------|-----|----------------------------------------------------------------------------------------------|
| 3V              | 15, 16, 17            | I   | 3-V V <sub>CC</sub> input for card power                                                     |
| 5V              | 1, 2, 30              | I   | 5-V V <sub>CC</sub> input for card power                                                     |
| 12V             | 7, 24                 | I   | 12-V V <sub>PP</sub> input for card power                                                    |
| AVCC            | 9, 10, 11             | O   | Switched output that delivers 0 V, 3.3 V, 5 V, or high impedance                             |
| AVPP            | 8                     | O   | Switched output that delivers 0 V, 3.3 V, 5 V, 12 V, or high impedance                       |
| APWR_GOOD       | 13                    | O   | Logic-level power-ready output that stays low as long as AVPP is within limits.              |
| BVCC            | 20, 21, 22            | O   | Switched output that delivers 0 V, 3.3 V, 5 V, or high impedance                             |
| BVPP            | 23                    | O   | Switched output that delivers 0 V, 3.3 V, 5 V, 12 V, or high impedance                       |
| BPWR_GOOD       | 19                    | O   | Logic-level power-ready output that stays low as long as BVPP is within limits.              |
| CLOCK           | 4                     | I   | Logic-level clock for serial data word                                                       |
| DATA            | 3                     | I   | Logic-level serial data word                                                                 |
| GND             | 12                    |     | Ground                                                                                       |
| LATCH           | 5                     | I   | Logic-level latch for serial data word                                                       |
| NC              | 6, 14, 26, 27, 28, 29 |     | No internal connection                                                                       |
| OC              | 18                    | O   | Logic-level overcurrent reporting output that goes low when an overcurrent condition exists. |
| V <sub>DD</sub> | 25                    |     | 5-V power to chip                                                                            |

# TPS2202, TPS2202Y DUAL-SLOT PC CARD POWER-INTERFACE SWITCHES FOR SERIAL PCMCIA CONTROLLERS

SLVS103A – DECEMBER 1994 – REVISED AUGUST 1995

## TPS2202Y chip information

This chip, when properly assembled, displays characteristics similar to the TPS2202. Thermal compression or ultrasonic bonding may be used on the doped aluminum bonding pads. The chips may be mounted with conductive epoxy or a gold-silicon preform.

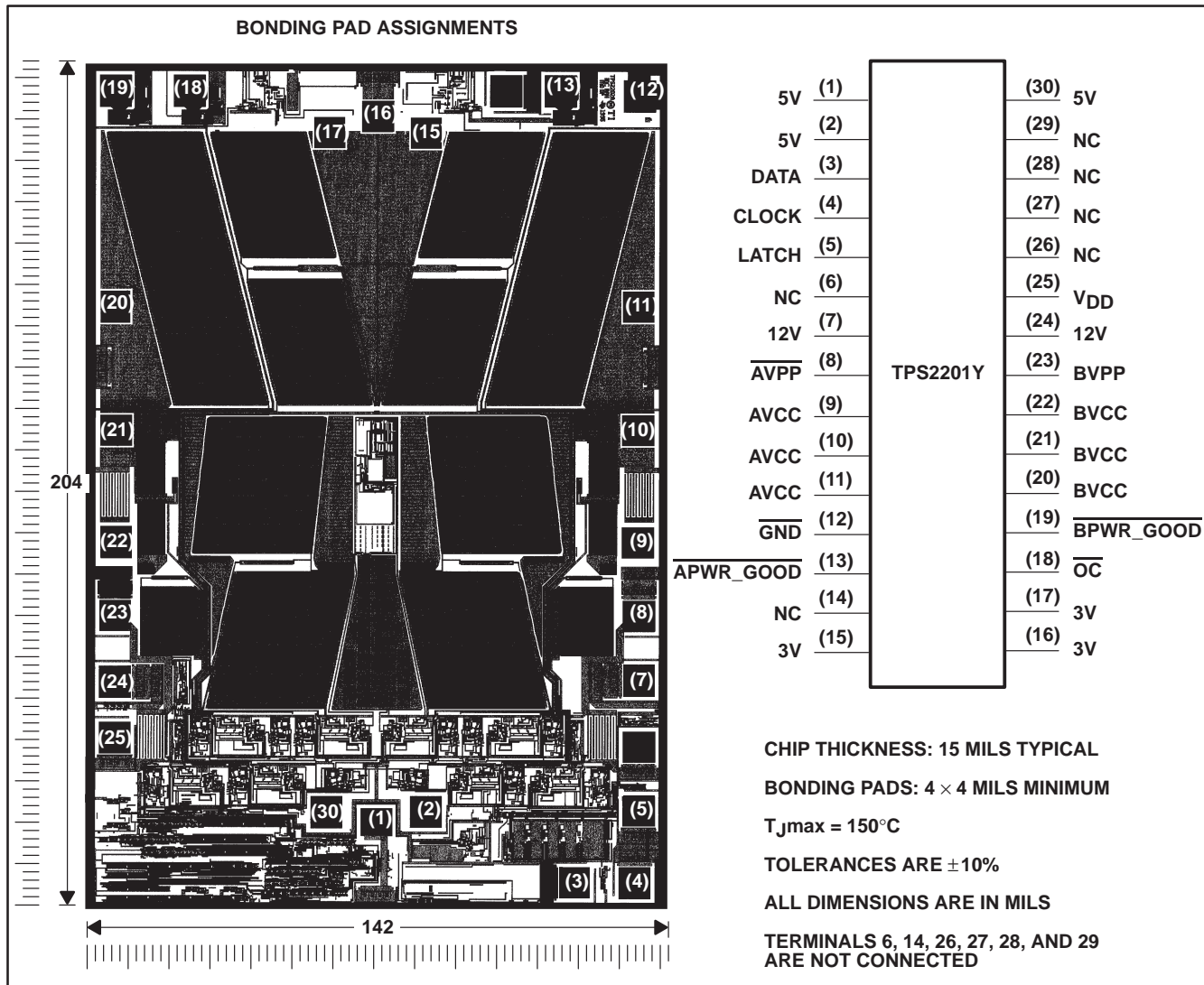



TPS2202, TPS2202Y  
**DUAL-SLOT PC CARD POWER-INTERFACE SWITCHES  
 FOR SERIAL PCMCIA CONTROLLERS**

SLVS103A – DECEMBER 1994 – REVISED AUGUST 1995

**electrical characteristics,  $T_A = 25^\circ\text{C}$ ,  $V_{DD} = 5\text{ V}$  (unless otherwise noted)**

**dc characteristics**

| PARAMETER                                                         |                               | TEST CONDITIONS                                                                                             | TPS2202 |       |      | UNIT          |
|-------------------------------------------------------------------|-------------------------------|-------------------------------------------------------------------------------------------------------------|---------|-------|------|---------------|
|                                                                   |                               |                                                                                                             | MIN     | TYP   | MAX  |               |
| Switch resistances <sup>†</sup>                                   | 5 V to xVCC                   |                                                                                                             |         |       | 160  | m $\Omega$    |
|                                                                   | 3 V to xVCC                   |                                                                                                             |         |       | 225  |               |
|                                                                   | 5 V to xVPP                   |                                                                                                             |         |       | 6    | $\Omega$      |
|                                                                   | 3 V to xVPP                   |                                                                                                             |         |       | 6    |               |
|                                                                   | 12 V to xVPP                  |                                                                                                             |         |       | 1    |               |
| Clamp low voltage                                                 |                               | $I_{pp}$ at 10 mA                                                                                           |         |       | 0.8  | V             |
| Clamp low voltage                                                 |                               | $I_{CC}$ at 10 mA                                                                                           |         |       | 0.8  | V             |
| Leakage current                                                   | $I_{pp}$ High-impedance state | $T_A = 25^\circ\text{C}$                                                                                    |         | 1     | 10   | $\mu\text{A}$ |
|                                                                   |                               | $T_A = 85^\circ\text{C}$                                                                                    |         |       | 50   |               |
|                                                                   | $I_{CC}$ High-impedance state | $T_A = 25^\circ\text{C}$                                                                                    |         | 1     | 10   |               |
|                                                                   |                               | $T_A = 85^\circ\text{C}$                                                                                    |         |       | 50   |               |
| Input current                                                     | $I_{DD}$                      | $V_O(\text{AVCC}) = V_O(\text{BVCC}) = 5\text{ V}$ ,<br>$V_O(\text{AVPP}) = V_O(\text{BVPP}) = 12\text{ V}$ |         | 83    | 150  | $\mu\text{A}$ |
|                                                                   | $I_{DD}$ in shutdown          | $V_O(\text{BVCC}) = V_O(\text{AVCC}) = V_O(\text{AVPP}) = V_O(\text{BVPP}) = \text{high Z}$                 |         |       | 1    | $\mu\text{A}$ |
| Power-ready threshold, $\overline{\text{PWR\_GOOD}}$              |                               |                                                                                                             | 10.72   | 11.05 | 11.4 | V             |
| Power-ready hysteresis, $\overline{\text{PWR\_GOOD}}$ (12-V mode) |                               |                                                                                                             |         | 50    |      | mV            |
| Short-circuit output-current limit                                | $I_O(\text{xVCC})$            | $T_J = 85^\circ\text{C}$ ,<br>Output powered up into a short to GND                                         | 0.75    | 1.3   | 1.9  | A             |
|                                                                   | $I_O(\text{xVPP})$            |                                                                                                             | 120     | 200   | 400  | mA            |

<sup>†</sup> Pulse-testing techniques maintain junction temperature close to ambient temperature; thermal effects must be taken into account separately.

**switching characteristics<sup>‡</sup>**

| PARAMETER                                  |                                        | TEST CONDITIONS    | TPS2202 |     |     | UNIT |
|--------------------------------------------|----------------------------------------|--------------------|---------|-----|-----|------|
|                                            |                                        |                    | MIN     | TYP | MAX |      |
| $t_r$ Output rise time                     |                                        | $V_O(\text{xVCC})$ |         | 1.2 |     | ms   |
|                                            |                                        | $V_O(\text{xVPP})$ |         | 5   |     |      |
| $t_f$ Output fall time                     |                                        | $V_O(\text{xVCC})$ |         | 10  |     | ms   |
|                                            |                                        | $V_O(\text{xVPP})$ |         | 14  |     |      |
| $t_{pd}$ Propagation delay (see Figure 1§) | LATCH $\uparrow$ to $V_O(\text{xVPP})$ | $t_{on}$           |         | 5.8 |     | ms   |
|                                            |                                        | $t_{off}$          |         | 18  |     |      |
|                                            | LATCH $\uparrow$ to xVCC (3 V)         | $t_{on}$           |         | 5.8 |     | ms   |
|                                            |                                        | $t_{off}$          |         | 28  |     |      |
|                                            | LATCH $\uparrow$ to xVCC (5 V)         | $t_{on}$           |         | 4   |     | ms   |
|                                            |                                        | $t_{off}$          |         | 30  |     |      |

<sup>‡</sup> Refer to Parameter Measurement Information

<sup>§</sup> Propagation delays are with  $C_L = 100\ \mu\text{F}$ .

**TPS2202, TPS2202Y**  
**DUAL-SLOT PC CARD POWER-INTERFACE SWITCHES**  
**FOR SERIAL PCMCIA CONTROLLERS**

SLVS103A – DECEMBER 1994 – REVISED AUGUST 1995

**electrical characteristics,  $T_A = 25^\circ\text{C}$ ,  $V_{DD} = 5\text{ V}$  (unless otherwise noted) (continued)**

**logic section**

| PARAMETER               | TEST CONDITIONS     | TPS2202        |     | UNIT          |
|-------------------------|---------------------|----------------|-----|---------------|
|                         |                     | MIN            | MAX |               |
| Logic input current     |                     |                | 1   | $\mu\text{A}$ |
| Logic input high level  |                     | 2.7            |     | V             |
| Logic input low level   |                     |                | 0.8 | V             |
| Logic output high level | $I_O = 1\text{ mA}$ | $V_{DD} - 0.4$ |     | V             |
| Logic output low level  |                     | 0.4            |     | V             |

**dc characteristics**

| PARAMETER                                                         | TEST CONDITIONS               | TPS2202Y                                                                                                    |       |     | UNIT          |
|-------------------------------------------------------------------|-------------------------------|-------------------------------------------------------------------------------------------------------------|-------|-----|---------------|
|                                                                   |                               | MIN                                                                                                         | TYP   | MAX |               |
| Leakage current                                                   | $I_{pp}$ High-impedance state |                                                                                                             | 1     |     | $\mu\text{A}$ |
|                                                                   | $I_{CC}$ High-impedance state |                                                                                                             | 1     |     |               |
| Input current                                                     | $I_{DD}$                      | $V_O(\text{AVCC}) = V_O(\text{BVCC}) = 5\text{ V}$ ,<br>$V_O(\text{AVPP}) = V_O(\text{BVPP}) = 12\text{ V}$ |       |     | $\mu\text{A}$ |
| Power-ready threshold, $\overline{\text{PWR\_GOOD}}$              |                               |                                                                                                             | 11.05 |     | V             |
| Power-ready hysteresis, $\overline{\text{PWR\_GOOD}}$ (12-V mode) |                               |                                                                                                             | 50    |     | mV            |

**switching characteristics†**

| PARAMETER                                  | TEST CONDITIONS                        | TPS2202Y  |     |     | UNIT |
|--------------------------------------------|----------------------------------------|-----------|-----|-----|------|
|                                            |                                        | MIN       | TYP | MAX |      |
| $t_r$ Output rise time                     | $V_O(\text{xVCC})$                     |           | 1.2 |     | ms   |
|                                            | $V_O(\text{xVPP})$                     |           | 5   |     |      |
| $t_f$ Output fall time                     | $V_O(\text{xVCC})$                     |           | 10  |     | ms   |
|                                            | $V_O(\text{xVPP})$                     |           | 14  |     |      |
| $t_{pd}$ Propagation delay (see Figure 1‡) | LATCH $\uparrow$ to $V_O(\text{xVPP})$ | $t_{on}$  | 5.8 |     | ms   |
|                                            |                                        | $t_{off}$ | 18  |     |      |
|                                            | LATCH $\uparrow$ to xVCC               | $t_{on}$  | 5.8 |     | ms   |
|                                            |                                        | $t_{off}$ | 28  |     |      |
|                                            | LATCH $\uparrow$ to xVCC               | $t_{on}$  | 4   |     | ms   |
|                                            |                                        | $t_{off}$ | 30  |     |      |

† Refer to Parameter Measurement Information

‡ Propagation delays are with  $C_L = 100\ \mu\text{F}$ .



**PARAMETER MEASUREMENT INFORMATION**

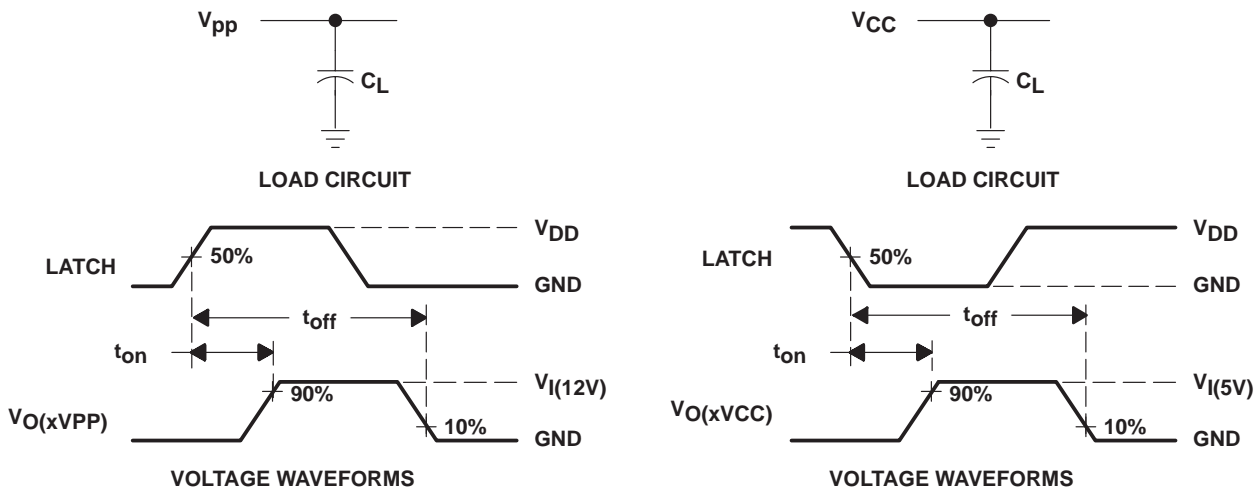

**Figure 1. Test Circuits and Voltage Waveforms**

**Table of Timing Diagrams**

|                                                                           | FIGURE |
|---------------------------------------------------------------------------|--------|
| Serial-Interface Timing                                                   | 2      |
| xVCC Propagation Delay and Rise Times With 1- $\mu$ F Load, 3-V Switch    | 3      |
| xVCC Propagation Delay and Fall Times With 1- $\mu$ F Load, 3-V Switch    | 4      |
| xVCC Propagation Delay and Rise Times With 100- $\mu$ F Load, 3-V Switch  | 5      |
| xVCC Propagation Delay and Fall Times With 100- $\mu$ F Load, 3-V Switch  | 6      |
| xVCC Propagation Delay and Rise Times With 1- $\mu$ F Load, 5-V Switch    | 7      |
| xVCC Propagation Delay and Fall Times With 1- $\mu$ F Load, 5-V Switch    | 8      |
| xVCC Propagation Delay and Rise Times With 100- $\mu$ F Load, 5-V Switch  | 9      |
| xVCC Propagation Delay and Fall Times With 100- $\mu$ F Load, 5-V Switch  | 10     |
| xVPP Propagation Delay and Rise Times With 1- $\mu$ F Load, 12-V Switch   | 11     |
| xVPP Propagation Delay and Fall Times With 1- $\mu$ F Load, 12-V Switch   | 12     |
| xVPP Propagation Delay and Rise Times With 100- $\mu$ F Load, 12-V Switch | 13     |
| xVPP Propagation Delay and Fall Times With 100- $\mu$ F Load, 12-V Switch | 14     |

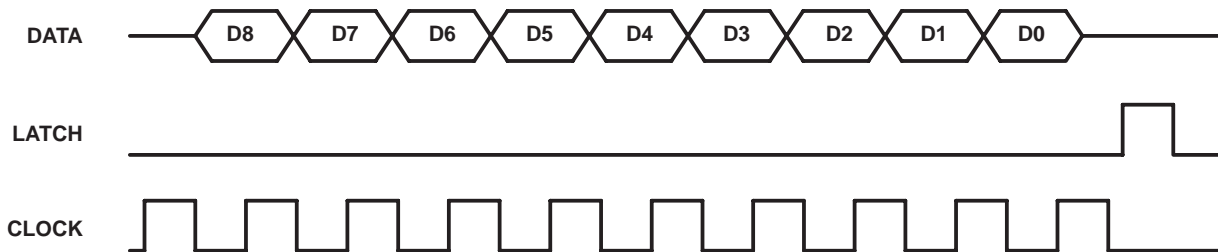

NOTE A. Data is clocked in on the a positive leading edge of the clock. The latch should occur before next positive leading edge of the clock. For definition of D0–D8, see control logic table.

**Figure 2. Serial-Interface Timing**

PARAMETER MEASUREMENT INFORMATION

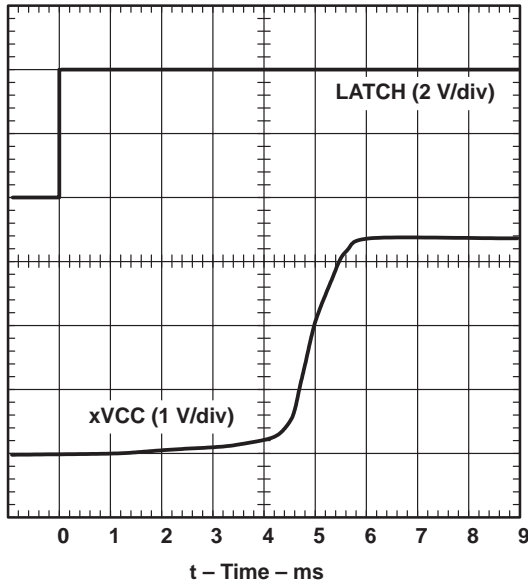

Figure 3. xVCC Propagation Delay and Rise Times With 1- $\mu$ F Load, 3-V Switch

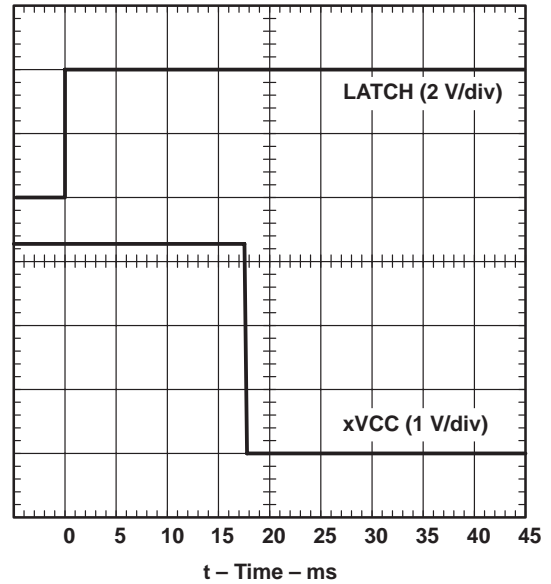

Figure 4. xVCC Propagation Delay and Fall Times With 1- $\mu$ F Load, 3-V Switch

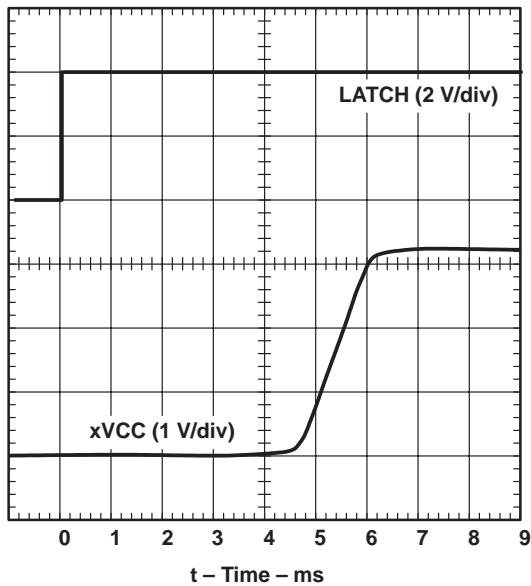

Figure 5. xVCC Propagation Delay and Rise Times With 100- $\mu$ F Load, 3-V Switch

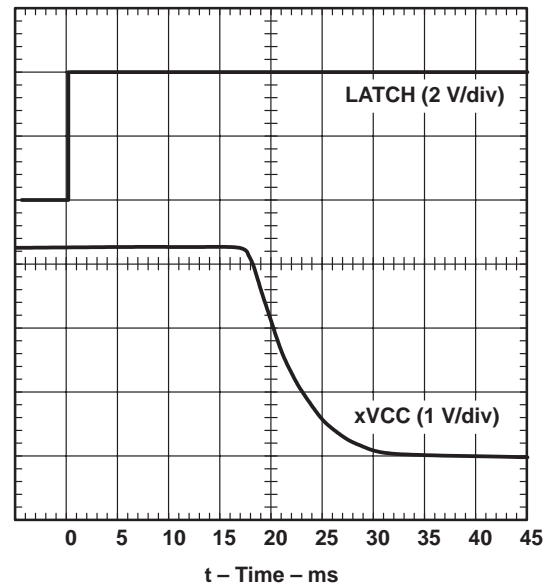
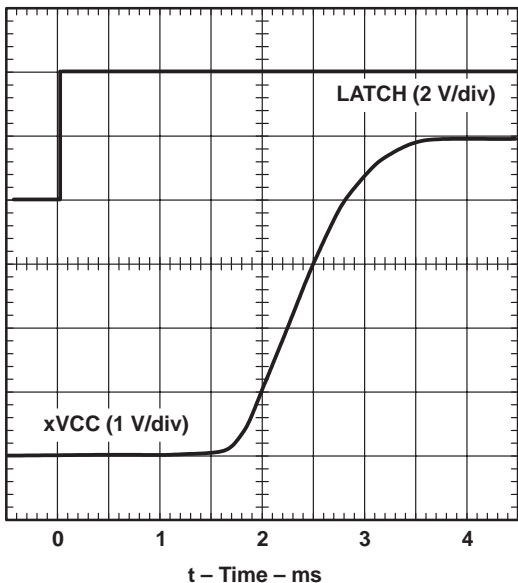

Figure 6. xVCC Propagation Delay and Fall Times With 100- $\mu$ F Load, 3-V Switch



**PARAMETER MEASUREMENT INFORMATION**



**Figure 7. xVCC Propagation Delay and Rise Times With 1- $\mu$ F Load, 5-V Switch**

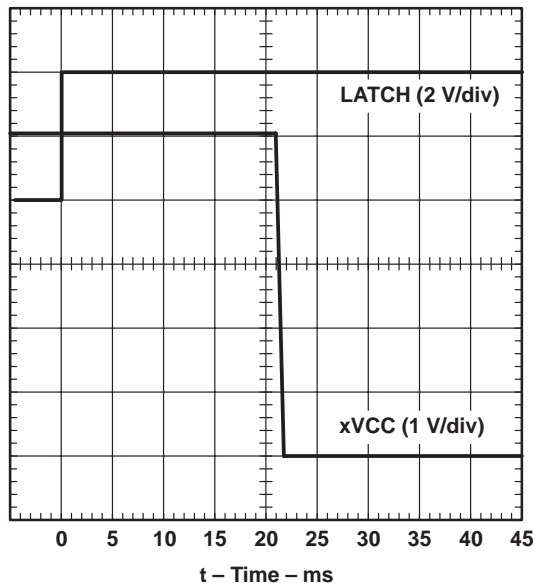

**Figure 8. xVCC Propagation Delay and Fall Times With 1- $\mu$ F Load, 5-V Switch**

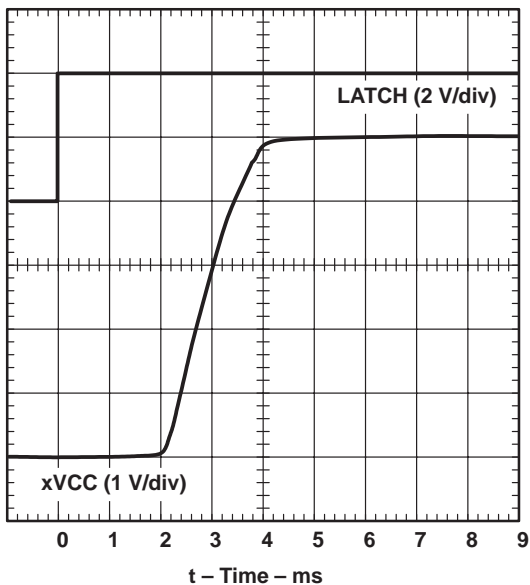

**Figure 9. xVCC Propagation Delay and Rise Times With 100- $\mu$ F Load, 5-V Switch**

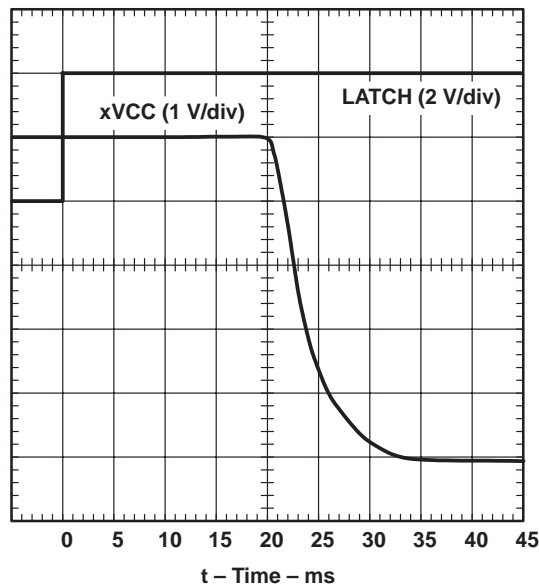

**Figure 10. xVCC Propagation Delay and Fall Times With 100- $\mu$ F Load, 5-V Switch**

TPS2202, TPS2202Y  
 DUAL-SLOT PC CARD POWER-INTERFACE SWITCHES  
 FOR SERIAL PCMCIA CONTROLLERS

SLVS103A – DECEMBER 1994 – REVISED AUGUST 1995

PARAMETER MEASUREMENT INFORMATION

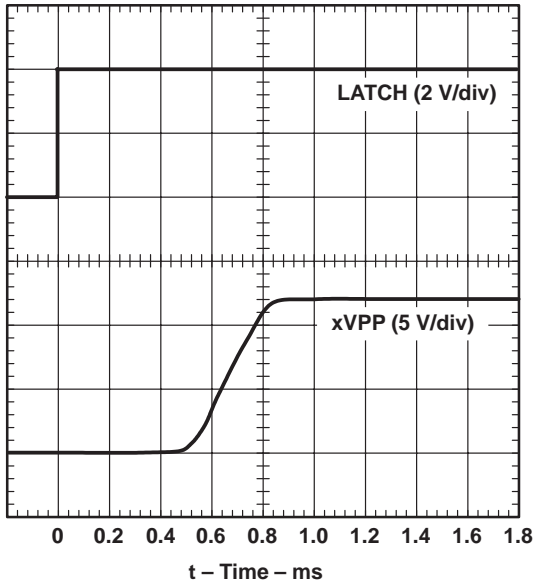

Figure 11. xVPP Propagation Delay and Rise Times With 1- $\mu$ F Load, 12-V Switch

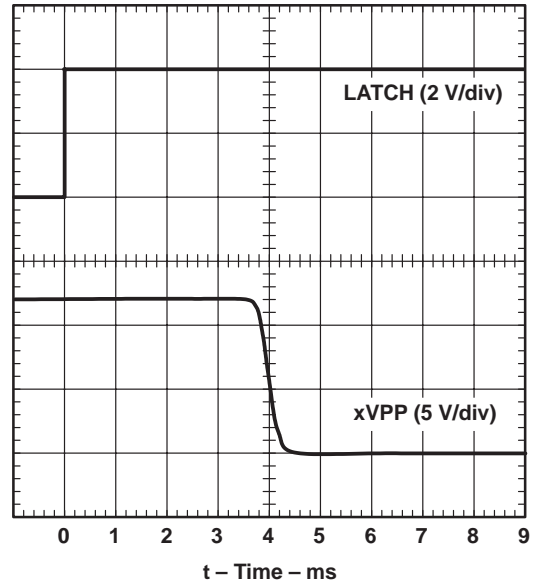

Figure 12. xVPP Propagation Delay and Fall Times With 1- $\mu$ F Load, 12-V Switch

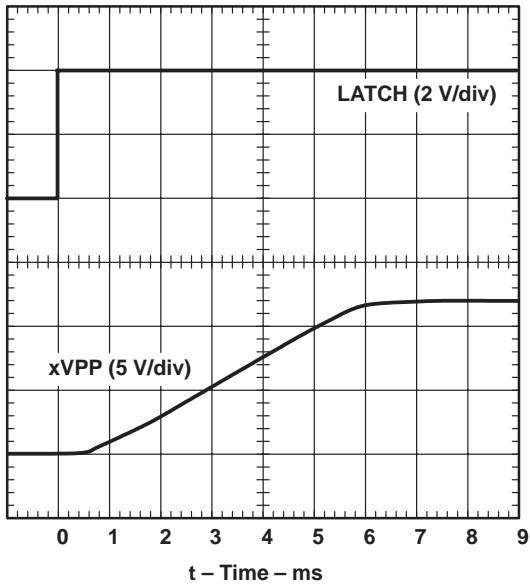

Figure 13. xVPP Propagation Delay and Rise Times With 100- $\mu$ F Load, 12-V Switch

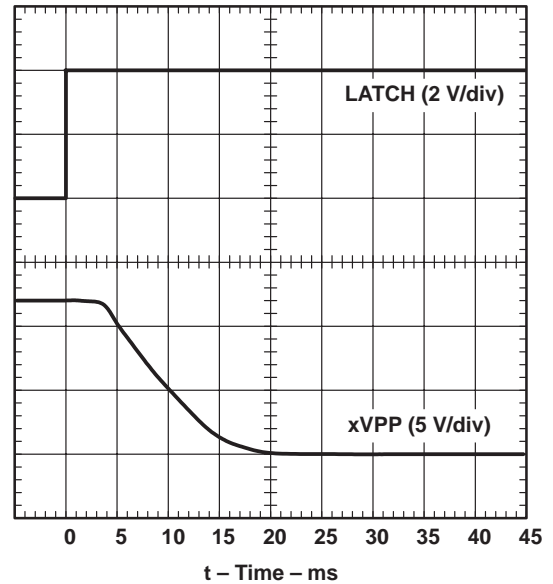

Figure 14. xVPP Propagation Delay and Fall Times With 100- $\mu$ F Load, 12-V Switch

TPS2202, TPS2202Y  
**DUAL-SLOT PC CARD POWER-INTERFACE SWITCHES  
 FOR SERIAL PCMCIA CONTROLLERS**

SLVS103A – DECEMBER 1994 – REVISED AUGUST 1995

**TYPICAL CHARACTERISTICS†**

**Table of Graphs**

|                |                                                      |                         | FIGURE |
|----------------|------------------------------------------------------|-------------------------|--------|
| $I_{DD}$       | Supply current                                       | vs Junction temperature | 15     |
| $r_{DS(on)}$   | Static drain-source on-state resistance, 3-V switch  | vs Junction temperature | 16     |
| $r_{DS(on)}$   | Static drain-source on-state resistance, 5-V switch  | vs Junction temperature | 17     |
| $r_{DS(on)}$   | Static drain-source on-state resistance, 12-V switch | vs Junction temperature | 18     |
| $V_O(xVCC)$    | Output voltage, 5-V switch                           | vs Output current       | 19     |
| $V_O(xVCC)$    | Output voltage, 3-V switch                           | vs Output current       | 20     |
| $xV_{pp}$      | Output voltage, $V_{pp}$ switch                      | vs Output current       | 21     |
| $I_{SC}(xVCC)$ | Short-circuit current, 5-V switch                    | vs Junction temperature | 22     |
| $I_{SC}(xVPP)$ | Short-circuit current, 12-V switch                   | vs Junction temperature | 23     |

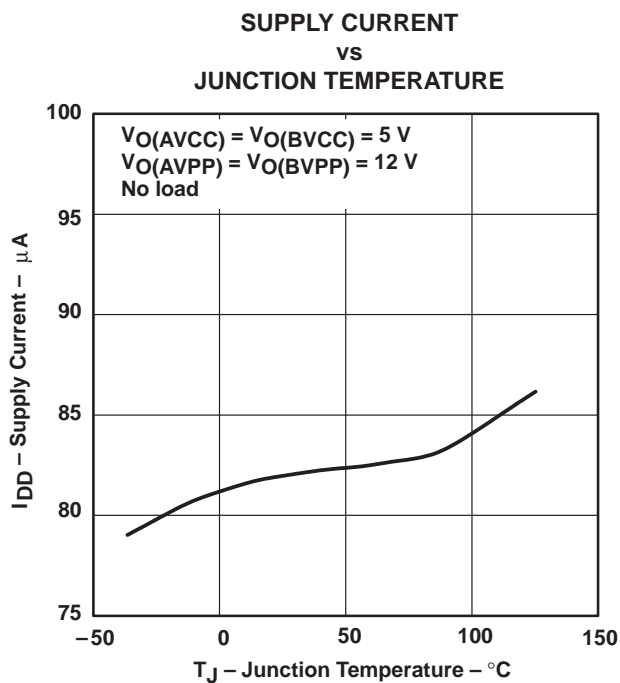

**Figure 15**

† t = pulse tested

**TPS2202, TPS2202Y**  
**DUAL-SLOT PC CARD POWER-INTERFACE SWITCHES**  
**FOR SERIAL PCMCIA CONTROLLERS**

SLVS103A – DECEMBER 1994 – REVISED AUGUST 1995

**TYPICAL CHARACTERISTICS†**

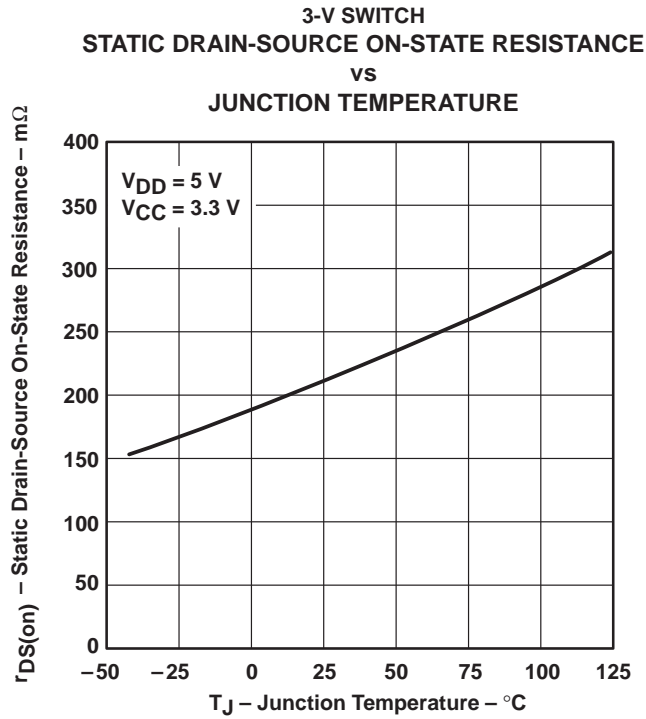

**Figure 16**

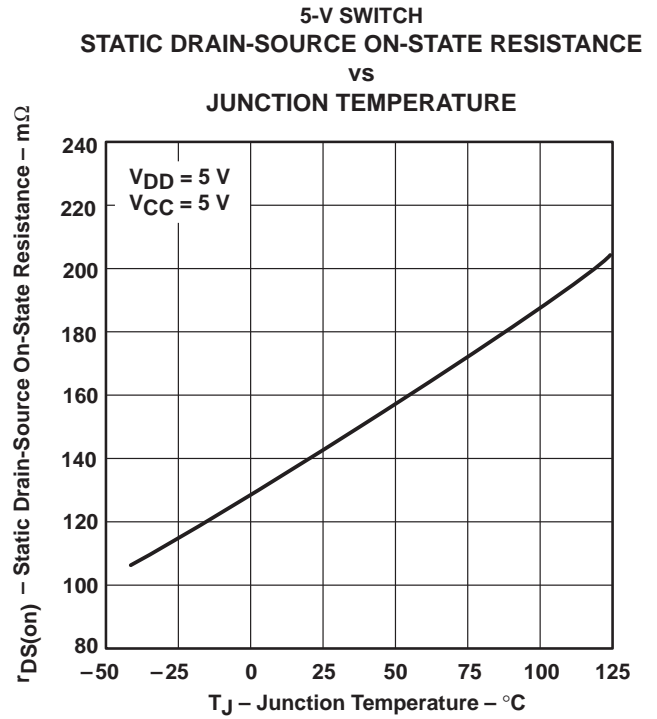

**Figure 17**

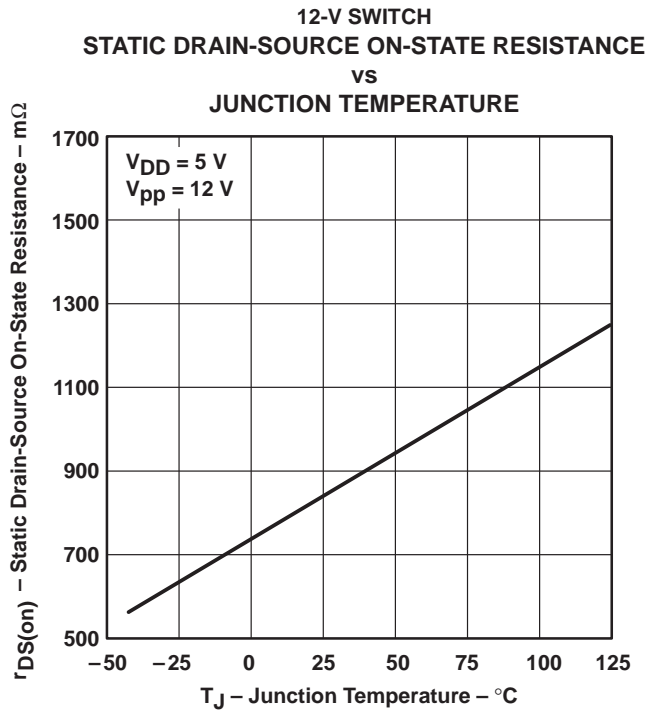

**Figure 18**

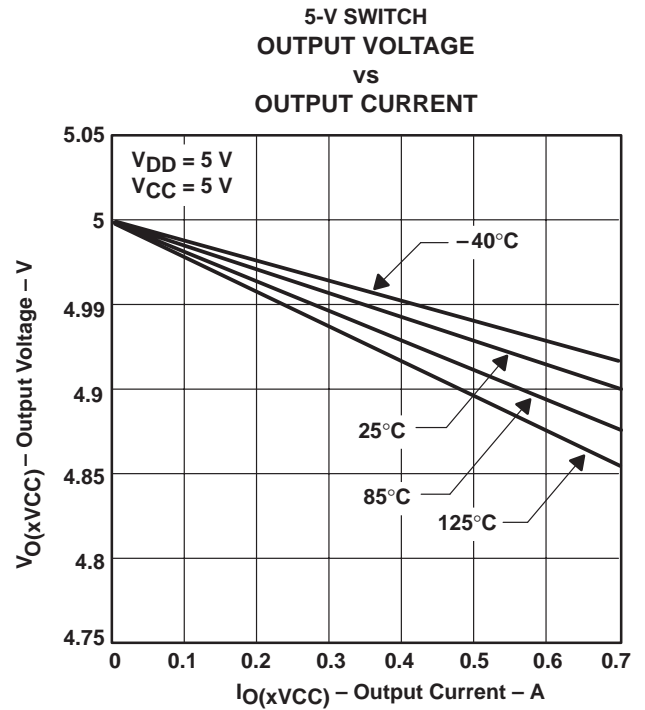

**Figure 19**

† t = pulse tested

TYPICAL CHARACTERISTICS†

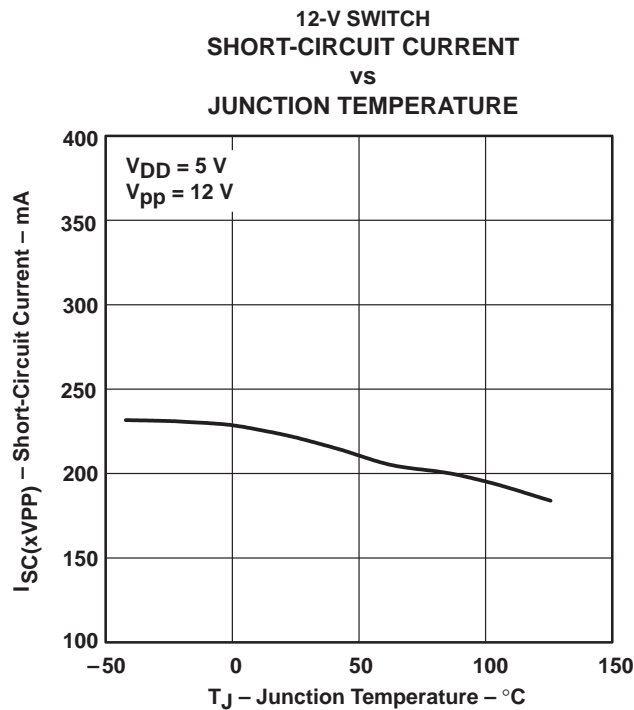
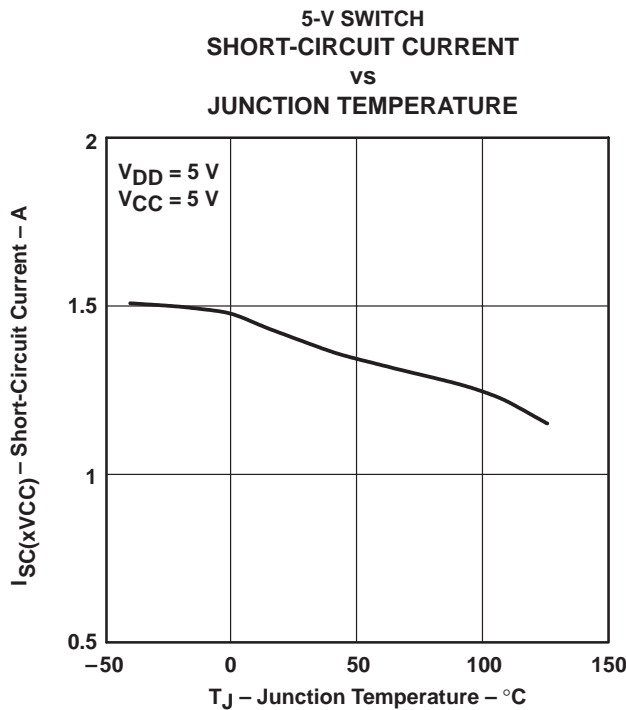
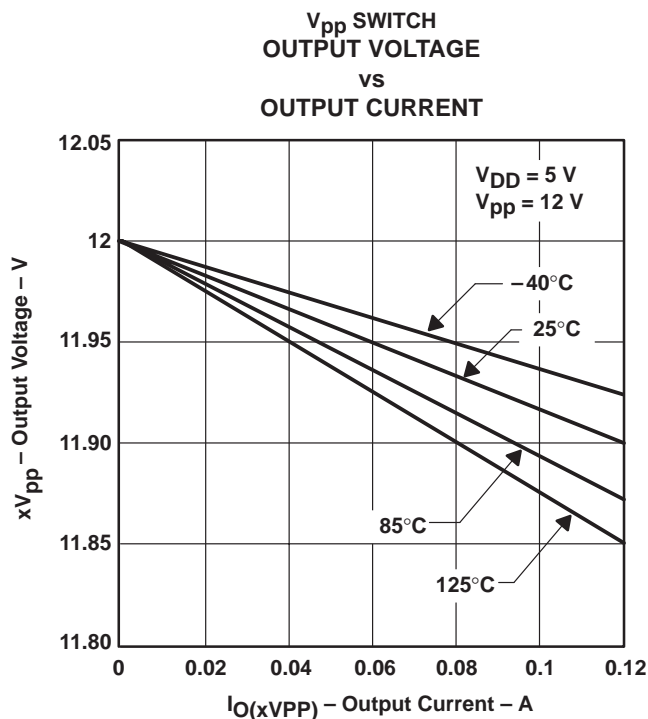
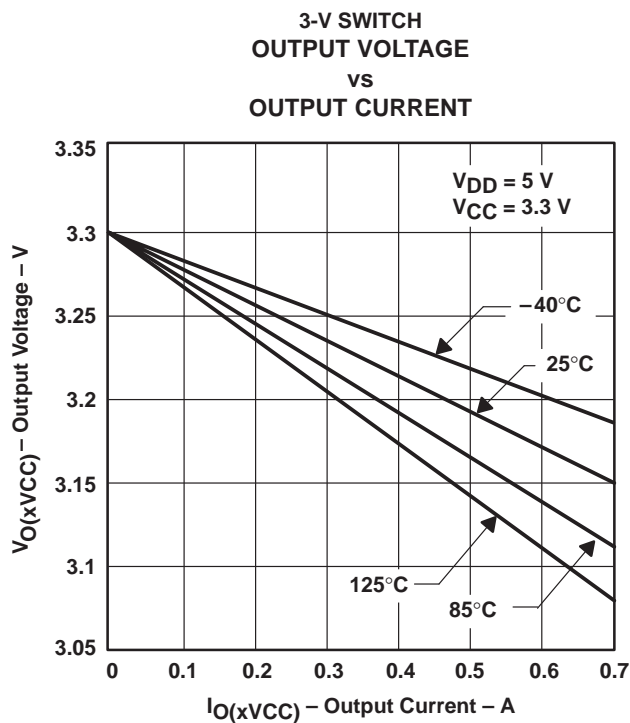

† t = pulse tested

# TPS2202, TPS2202Y DUAL-SLOT PC CARD POWER-INTERFACE SWITCHES FOR SERIAL PCMCIA CONTROLLERS

SLVS103A – DECEMBER 1994 – REVISED AUGUST 1995

---

## APPLICATION INFORMATION

### overview

PC Cards were initially introduced as a means to add EEPROM (flash memory) to portable computers with limited on-board memory. The idea of add-in cards quickly took hold: modems, wireless LANs, GPS systems, multimedia, and hard-disk versions were soon available. As the number of PC Card applications grew, the engineering community quickly recognized the need for a standard to ensure compatibility across platforms. To this end, the PCMCIA (Personal Computer Memory Card International Association) was established and was comprised of members from leading computer, software, PC card, and semiconductor manufacturers. One key goal was to realize the concept of plug and play – cards and hosts from different vendors should be compatible and able to communicate with one another transparently.

### PC Card power specification

System compatibility also means power compatibility. The most current set of specifications (PC Card Standard) set forth by the PCMCIA committee states that power is to be transferred between the host and the card through eight of the PC Card connector's 68 pins. This power interface consists of two  $V_{CC}$ , two  $V_{pp}$ , and four ground pins. Multiple  $V_{CC}$  and ground pins minimize connector-pin and line resistance. The two  $V_{pp}$  pins were originally specified as separate signals but are commonly tied together in the host to form a single node to minimize voltage losses. Card primary power is supplied through the  $V_{CC}$  pins; flash-memory programming and erase voltage is supplied through the  $V_{pp}$  pins. As each pin is rated to 0.5 A,  $V_{CC}$  and  $V_{pp}$  can theoretically supply up to 1 A, assuming equal pin resistance and no pin failure. A conservative design would limit current to 500 mA. Some applications, however, require higher  $V_{CC}$  currents; disk drives, for example, may need as much as 750-mA peak current to create the initial torque necessary to spin up the platter.  $V_{pp}$  currents, on the other hand, are defined by flash-memory programming requirements, typically under 120 mA.

### future power trends

The 1-A physical-pin current alluded to in the PC Card specification has caused some host-system engineers to believe they are required to deliver 1 A within the voltage tolerance of the card. Future applications, such as RF cards, could use the extra power for their radio transmitters. The 5 W needed for these cards will require very robust power supplies and special cooling considerations. The limited number of host sockets that will be able to support them makes the market for these high-powered PC Cards uncertain. The vast majority of the cards require less than 600 mA continuous current and the trend is towards even lower-powered PC Cards that will assure compatibility with a greater number of host systems. Recognizing the need for power derating, an adhoc committee of the PCMCIA is currently working to limit the amount of steady-state dc current to the PC Card to something less than the currently implied 1 A. If a system is designed to support 1 A, then the switch  $r_{DS(on)}$ , power supply requirements, and PC Card cooling need to be carefully considered.

### designing around 1-A delivery

Delivering 1 A means minimizing voltage (and power) losses across the PC Card power interface, which requires that designers trade off switch resistance and the cost associated with large-die (low  $r_{DS(on)}$ ) MOSFET transistors. The PC Card standard requires that 5 V  $\pm 5\%$ , or 3.3 V  $\pm 0.3$  V be supplied to the card. The approximate 10% tolerance for the 3.3-V supply makes the 3.3-V  $r_{DS(on)}$  less critical than the 5-V switch. A conservative approach is to allow 2% for voltage-regulator tolerance and 1% for etch- and terminal-resistance drops, which leaves 2% (100 mV) voltage drop for the 5-V switch, and at least 6% (198 mV) for the 3.3-V switch.

Calculating the  $r_{DS(on)}$  necessary to support a 100 mV or 198 mV switch loss, using  $R = E/I$  and setting  $I = 1$  A, the 5-V and 3.3-V switches would need to be 100 m $\Omega$  and 198 m $\Omega$  respectively. One solution would be to pay for a more expensive switch with lower  $r_{DS(on)}$ . A second, less expensive approach is to increase the headroom of the power supply—for example, to increase the 5-V supply 1.5% or to 5.075  $\pm 2\%$ . Working through the numbers once more, the 2% for the regulator plus 1% for etch and terminal losses leaves 97% or 4.923 V.



---

## APPLICATION INFORMATION

### designing around 1-A delivery (continued)

The allowable voltage loss across the power distribution switch is now 4.923 V minus 4.750 V or 173 mV. Therefore, a switch with 173 m $\Omega$  or less could deliver 1 A or greater. Setting the power supply high is a common practice for delivering voltages to allow for system switch, connector, and etch losses and has a minimal effect on overall battery life. In the example above, setting the power supply 1.5% high would only decrease a 3-hour battery life by approximately 2.7 minutes, trivial when compared with the decrease in battery life when running a 5-W PC Card.

### heat dissipation

A greater concern in delivering 1 A or 5 W is the ability of the host to dissipate the heat generated by the PC Card. For desktop computers the solution is simpler: locate the PC Card cage such that it receives convection cooling from the forced air of the fan. Notebooks and other handheld equipment are not be able to rely on convection, but must rely on conduction of heat away from the PC Card through the rails into the card cage. This is difficult because PC Card/card cage heat transfer is very poor. A typical design scenario would require the PC Card to be held at 60°C maximum with the host platform operating as high as 50°C. Preliminary testing reveals that a PC Card can have a 20°C rise, exceeding the 10°C differential in the example, when dissipating less than 2 W of continuous power. The 60°C temperature was chosen because it is the maximum operating temperature allowable by PC Card specification. Power handling requirements and temperature rises are topics of concern and are currently being addressed by the PCMCIA committee.

### overcurrent and over-temperature protection

PC Cards are inherently subject to damage that can result from mishandling. Host systems require protection against short-circuited cards that could lead to power supply or PCB-trace damage. Even systems sufficiently robust to withstand a short circuit would still undergo rapid battery discharge into the damaged PC Card, resulting in the rather sudden and unacceptable loss of system power. This can be particularly frustrating to the consumer who has already experienced problems with shortened battery life due to improper Nicad conditioning or memory effect. Most hosts include fuses for protection. The reliability of fused systems is poor, though, as blown fuses require troubleshooting and repair, usually by the manufacturer. The TPS2202 takes a two-pronged approach to overcurrent protection. First, instead of fuses, sense FETs monitor each of the power outputs. Excessive current generates an error signal that linearly limits the output current, preventing host damage or failure. Sense FETs, unlike sense resistors or polyfuses, have the added advantage that they do not add to the series resistance of the switch and thus produce no additional voltage losses. Second, when an overcurrent condition is detected, the TPS2202 asserts a signal at  $\overline{OC}$  that can be monitored by the microprocessor to initiate diagnostics and/or send the user a warning message. In the event that an overcurrent condition persists, causing the IC to exceed its maximum junction temperature, thermal-protection circuitry engages, shutting down all power outputs until the device cools to within a safe operating region.

### 12-V supply not required

Most PC Card switches use the externally supplied 12-V  $V_{pp}$  power for switch-gate drive and other chip functions, requiring that it be present at all times. The TPS2202 offers considerable power savings by using an internal charge pump to generate the required higher voltages from the 5-V  $V_{DD}$  supply; therefore, the external 12-V supply can be disabled except when needed for flash-memory functions, thereby extending battery lifetime. Additional power savings are realized by the TPS2202 during a software shutdown, in which quiescent current drops to a maximum of 1  $\mu$ A.

### voltage transitioning requirement

PC Cards, like portables, are migrating from 5 V to 3.3 V to minimize power consumption, optimize board space, and increase logic speeds. The TPS2202 is designed to meet all combinations of power delivery as currently defined in the PCMCIA standard. The latest protocol accommodates mixed 3.3-V/5-V systems by first powering the card with 5 V, then polling it to determine its 3.3-V compatibility. The PCMCIA specification requires that the

# TPS2202, TPS2202Y

## DUAL-SLOT PC CARD POWER-INTERFACE SWITCHES

### FOR SERIAL PCMCIA CONTROLLERS

SLVS103A – DECEMBER 1994 – REVISED AUGUST 1995

---

## APPLICATION INFORMATION

### voltage transitioning requirement (continued)

capacitors on 3.3-V compatible cards be discharged to below 0.8 V before applying 3.3-V power. This ensures that sensitive 3.3-V circuitry is not subjected to any residual 5-V charge and functions as a power reset. The TPS2202 offers a selectable  $V_{CC}$  and  $V_{PP}$  ground state, in accordance with PCMCIA 3.3-V/5-V switching specifications, to fully discharge the card capacitors while switching between  $V_{CC}$  voltages.

### output ground switches

Several PCMCIA power-distribution switches on the market do not have an active-grounding FET switch. These devices do not meet the PC Card specification requiring a discharge of  $V_{CC}$  within 100 ms. PC Card resistance can not be relied on to provide a discharge path for voltages stored on PC Card capacitance because of possible high-impedance isolation by power-management schemes. A method commonly shown to alleviate this problem is to add to the switch output an external 100 k $\Omega$  resistor in parallel with the PC Card. Considering that this is the only discharge path to ground, a timing analysis will reveal that the RC time constant delays the required discharge time to over 2 seconds. The only way to ensure timing compatibility with PC Card standards is to use a power-distribution switch that has an internal ground switch, like that of the TPS22xx family, or add an external ground FET to each of the output lines with the control logic necessary to select it.

In summary, the TPS2202 is a complete single-chip dual-slot PC Card power interface. It meets all currently defined PCMCIA specifications for power delivery in 5-V, 3.3-V, and mixed systems, and offers a serial controller interface. The TPS2202 offers functionality, power savings, overcurrent and thermal protection, and fault reporting in one 30-pin SSOP surface-mount package for maximum value added to new portable designs.

### power supply considerations

The TPS2202 has multiple terminals for each of its 3.3 V, 5 V, and 12 V power inputs and for the switched  $V_{CC}$  outputs. Any individual terminal can conduct the rated input or output current. Unless all terminals are connected in parallel, the series resistance is significantly higher than that specified, resulting in increased voltage drops and lost power. Both 12 V inputs must be connected for proper  $V_{PP}$  switching; it is recommended that all input and output power terminals be paralleled for optimum operation. The  $V_{DD}$  input lead must be connected to the 5V input leads.

Although the TPS2202 is fairly immune to power input fluctuations and noise, it is generally considered good design practice to bypass power supplies typically with a 1- $\mu$ F electrolytic or tantalum capacitor paralleled by a 0.047- $\mu$ F to 0.1- $\mu$ F ceramic capacitor. It is strongly recommended that the switched  $V_{CC}$  and  $V_{PP}$  outputs be bypassed with a 0.1- $\mu$ F or larger capacitor; doing so improves the immunity of the TPS2202 to electrostatic discharge (ESD). Care should be taken to minimize the inductance of PCB traces between the TPS2202 and the load. High switching currents can produce large negative-voltage transients, which forward biases substrate diodes, resulting in unpredictable performance.

The TPS2202, unlike other PC Card power-interface switches, does not use the 12-V power supply for switching or other chip functions. Instead, an internal charge pump generates the necessary voltage from  $V_{DD}$ , allowing the 12-V input supply to be shut down except when the  $V_{PP}$  programming or erase voltage is needed. Careful system design making use of this feature reduces power consumption and extends battery lifetime.

The 3.3-V power input should not be taken higher than the 5-V input. Doing so, though nondestructive, results in high current flow into the device, and could result in abnormal operation. In any case, this occurrence indicates a malfunction of one input voltage or both, which should be investigated.

Similarly, no terminal should be taken below  $-0.3$  V; forward biasing the parasitic-substrate diode results in substrate currents and unpredictable performance.





## APPLICATION INFORMATION

### overcurrent and thermal protection

The TPS2202 uses sense FETs to check for overcurrent conditions in each of the  $V_{CC}$  and  $V_{pp}$  outputs. Unlike sense resistors or polyfuses, these FETs do not add to the series resistance of the switch; therefore, voltage and power losses are reduced. Overcurrent sensing is applied to each output separately. When an overcurrent condition is detected, only the power output affected is limited; all other power outputs continue to function normally. The  $\overline{OC}$  indicator, normally a logic high, is a logic low when any overcurrent condition is detected, providing for initiation of system diagnostics and/or sending a warning message to the user.

During power up, the TPS2202 controls the rise time of the  $V_{CC}$  and  $V_{pp}$  outputs and limits the current into a faulty card or connector. If a short circuit is applied after power is established (e.g., hot insertion of a bad card), current is initially limited only by the impedance between the short and the power supply. In extreme cases, as much as 10 A to 15 A may flow into the short before the current limiting of the TPS2202 engages. If the  $V_{CC}$  or  $V_{pp}$  outputs are driven below ground, the TPS2202 may latch nondestructively in an off state. Cycling power reestablishes normal operation.

Overcurrent limiting for the  $V_{CC}$  outputs is designed to engage if powered up into a short in the range of 0.75 A to 1.9 A, typically at about 1.3 A; the  $V_{pp}$  outputs limit from 120 mA to 400 mA, typically around 200 mA. The protection circuitry acts by linearly limiting the current passing through the switch, rather than initiating a full shutdown of the supply. Shutdown occurs only during thermal limiting.

Thermal limiting prevents destruction of the IC from overheating when the package power-dissipation ratings are exceeded. Thermal limiting, disables all power outputs (both A and B slots) until the device has cooled.

### calculating junction temperature

The switch resistance,  $r_{DS(on)}$ , is dependent on the junction temperature,  $T_J$ , of the die. The junction temperature is dependent on both  $r_{DS(on)}$  and the current through the switch. To calculate  $T_J$ , first find  $r_{DS(on)}$  from Figures 16, 17, and 18 using an initial temperature estimate about 50°C above ambient. Then calculate the power dissipation for each switch, using the formula:

$$P_D = r_{DS(on)} \cdot I^2$$

Next, sum the power dissipation and calculate the junction temperature:

$$T_J = \left( \sum P_D \cdot R_{\theta JA} \right) + T_A, \quad R_{\theta JA} = 108^\circ\text{C/W}$$

Compare the calculated junction temperature with the initial temperature estimate. If they are not within a few degrees of each other, reiterate using the calculated temperature as the initial estimate.

### logic input and outputs

The serial interface consists of DATA, CLOCK, and LATCH leads. The data is clocked in on the positive leading edge of the clock (see Figure 2). The 9-bit (D0 through D8) serial data word is loaded during the positive edge of the latch signal. The latch signal should occur before the next positive leading edge of the clock.

The shutdown bit of the data word places all  $V_{CC}$  and  $V_{pp}$  outputs in a high-impedance state and reduces chip quiescent current to 1  $\mu\text{A}$  to conserve battery power.

The TPS2202 serial interface is designed to be compatible with serial-interface PCMCIA controllers and current PCMCIA and JEIDA standards.

An overcurrent output ( $\overline{OC}$ ) is provided to indicate an overcurrent condition in any of the  $V_{CC}$  or  $V_{pp}$  outputs, as previously discussed.

**TPS2202, TPS2202Y**  
**DUAL-SLOT PC CARD POWER-INTERFACE SWITCHES**  
**FOR SERIAL PCMCIA CONTROLLERS**

SLVS103A – DECEMBER 1994 – REVISED AUGUST 1995

**APPLICATION INFORMATION**

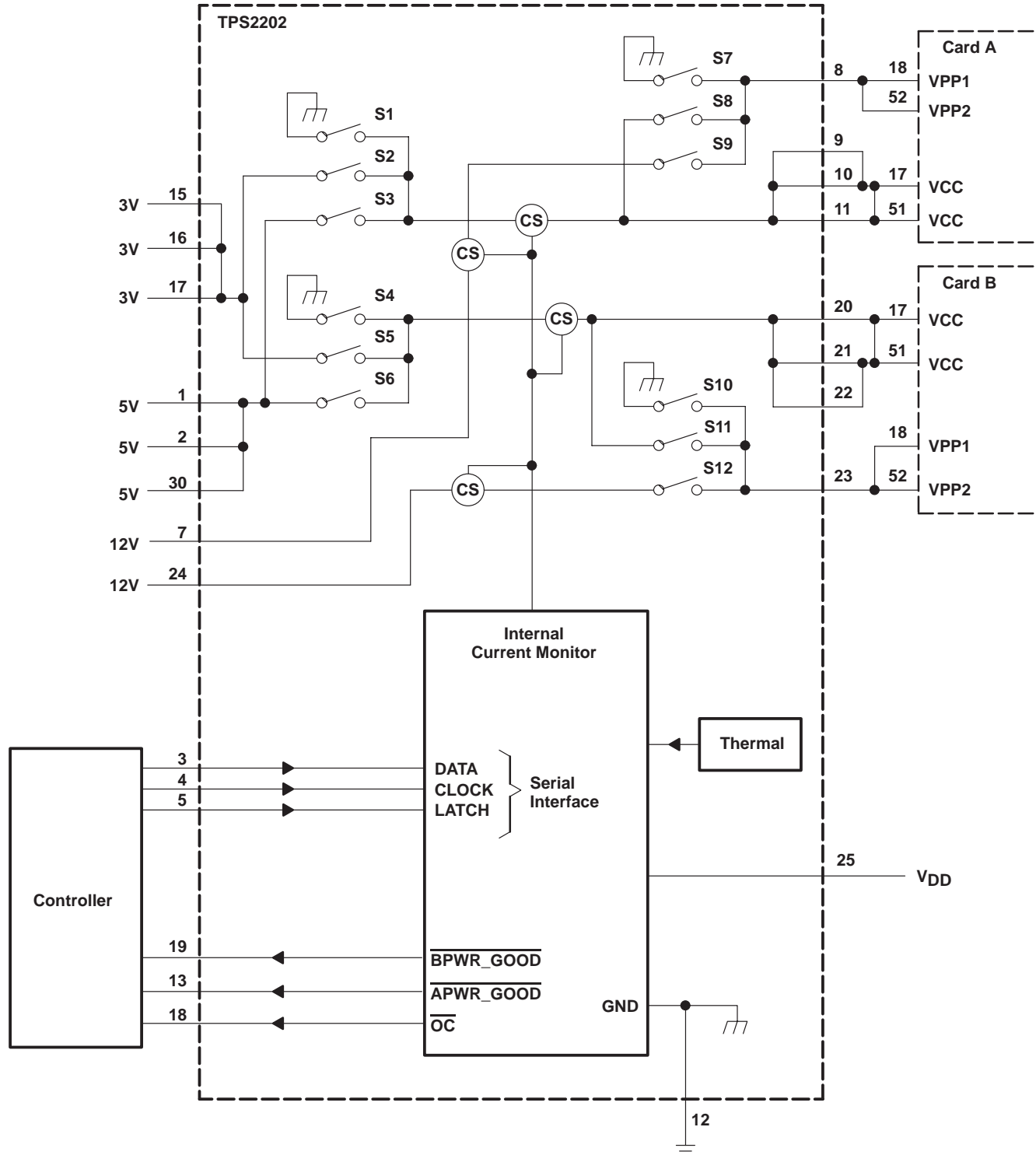

**Figure 24. Internal Switching Matrix**

TPS2202, TPS2202Y  
**DUAL-SLOT PC CARD POWER-INTERFACE SWITCHES  
 FOR SERIAL PCMCIA CONTROLLERS**

SLVS103A – DECEMBER 1994 – REVISED AUGUST 1995

**APPLICATION INFORMATION**

**TPS2202 control logic**

**AVPP**

| CONTROL SIGNALS |              |              | INTERNAL SWITCH SETTINGS |        |        | OUTPUT    |
|-----------------|--------------|--------------|--------------------------|--------|--------|-----------|
| D8 SHDN         | D0 A_VPP_PGM | D1 A_VPP_VCC | S7                       | S8     | S9     | VAVPP     |
| 1               | 0            | 0            | CLOSED                   | OPEN   | OPEN   | 0 V       |
| 1               | 0            | 1            | OPEN                     | CLOSED | OPEN   | VCC†      |
| 1               | 1            | 0            | OPEN                     | OPEN   | CLOSED | VPP(12 V) |
| 1               | 1            | 1            | OPEN                     | OPEN   | OPEN   | Hi-Z      |
| 0               | X            | X            | OPEN                     | OPEN   | OPEN   | Hi-Z      |

**BVPP**

| CONTROL SIGNALS |              |              | INTERNAL SWITCH SETTINGS |        |        | OUTPUT    |
|-----------------|--------------|--------------|--------------------------|--------|--------|-----------|
| D8 SHDN         | D4 B_VPP_PGM | D5 B_VPP_VCC | S10                      | S11    | S12    | VBVPP     |
| 1               | 0            | 0            | CLOSED                   | OPEN   | OPEN   | 0 V       |
| 1               | 0            | 1            | OPEN                     | CLOSED | OPEN   | VCC‡      |
| 1               | 1            | 0            | OPEN                     | OPEN   | CLOSED | VPP(12 V) |
| 1               | 1            | 1            | OPEN                     | OPEN   | OPEN   | Hi-Z      |
| 0               | X            | X            | OPEN                     | OPEN   | OPEN   | Hi-Z      |

**AVCC**

| CONTROL SIGNALS |           |           | INTERNAL SWITCH SETTINGS |        |        | OUTPUT |
|-----------------|-----------|-----------|--------------------------|--------|--------|--------|
| D8 SHDN         | D3 A_VCC3 | D2 A_VCC5 | S1                       | S2     | S3     | VAVCC  |
| 1               | 0         | 0         | CLOSED                   | OPEN   | OPEN   | 0 V    |
| 1               | 0         | 1         | OPEN                     | CLOSED | OPEN   | 3 V    |
| 1               | 1         | 0         | OPEN                     | OPEN   | CLOSED | 5 V    |
| 1               | 1         | 1         | CLOSED                   | OPEN   | OPEN   | 0 V    |
| 0               | X         | X         | OPEN                     | OPEN   | OPEN   | Hi-Z   |

**BVCC**

| CONTROL SIGNALS |           |           | INTERNAL SWITCH SETTINGS |        |        | OUTPUT |
|-----------------|-----------|-----------|--------------------------|--------|--------|--------|
| D8 SHDN         | D6 B_VCC3 | D7 B_VCC5 | S4                       | S5     | S6     | VBVCC  |
| 1               | 0         | 0         | CLOSED                   | OPEN   | OPEN   | 0 V    |
| 1               | 0         | 1         | OPEN                     | CLOSED | OPEN   | 3 V    |
| 1               | 1         | 0         | OPEN                     | OPEN   | CLOSED | 5 V    |
| 1               | 1         | 1         | CLOSED                   | OPEN   | OPEN   | 0 V    |
| 0               | X         | X         | OPEN                     | OPEN   | OPEN   | Hi-Z   |

† Output depends on AVCC

‡ Output depends on BVCC

**ESD protection**

All TPS2202 inputs and outputs incorporate ESD-protection circuitry designed to withstand a 2-kV human-body-model discharge as defined in MIL-STD-883C, Method 3015. The V<sub>CC</sub> and V<sub>pp</sub> outputs can be exposed to potentially higher discharges from the external environment through the PC Card connector. Bypassing the outputs with 0.1-μF capacitors protects the devices from discharges up to 10 kV.



**TPS2202, TPS2202Y**  
**DUAL-SLOT PC CARD POWER-INTERFACE SWITCHES**  
**FOR SERIAL PCMCIA CONTROLLERS**

SLVS103A – DECEMBER 1994 – REVISED AUGUST 1995

**APPLICATION INFORMATION**

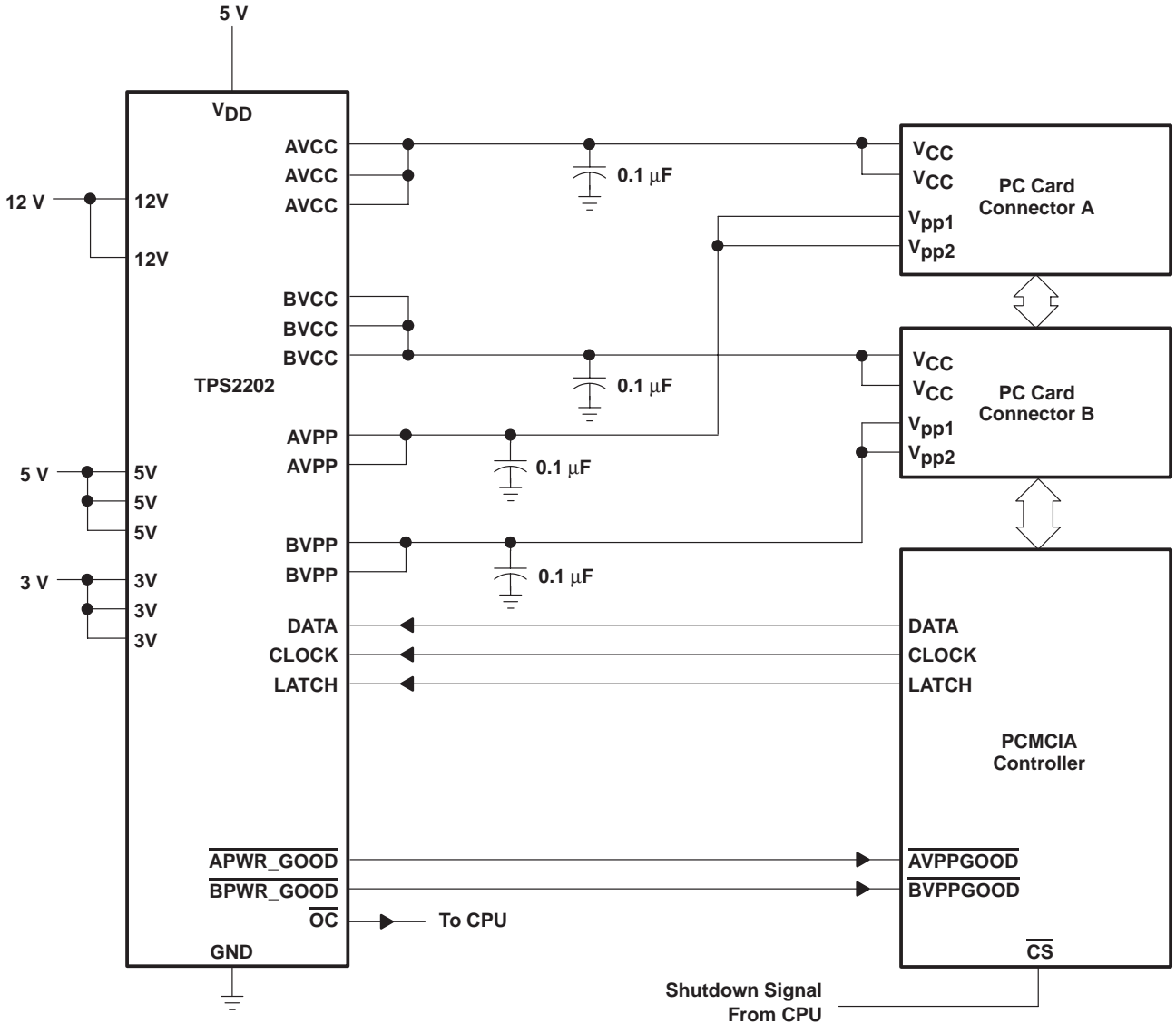

**Figure 25. Detailed Interconnections and Capacitor Recommendations**

## IMPORTANT NOTICE

Texas Instruments and its subsidiaries (TI) reserve the right to make changes to their products or to discontinue any product or service without notice, and advise customers to obtain the latest version of relevant information to verify, before placing orders, that information being relied on is current and complete. All products are sold subject to the terms and conditions of sale supplied at the time of order acknowledgement, including those pertaining to warranty, patent infringement, and limitation of liability.

TI warrants performance of its semiconductor products to the specifications applicable at the time of sale in accordance with TI's standard warranty. Testing and other quality control techniques are utilized to the extent TI deems necessary to support this warranty. Specific testing of all parameters of each device is not necessarily performed, except those mandated by government requirements.

CERTAIN APPLICATIONS USING SEMICONDUCTOR PRODUCTS MAY INVOLVE POTENTIAL RISKS OF DEATH, PERSONAL INJURY, OR SEVERE PROPERTY OR ENVIRONMENTAL DAMAGE ("CRITICAL APPLICATIONS"). TI SEMICONDUCTOR PRODUCTS ARE NOT DESIGNED, AUTHORIZED, OR WARRANTED TO BE SUITABLE FOR USE IN LIFE-SUPPORT DEVICES OR SYSTEMS OR OTHER CRITICAL APPLICATIONS. INCLUSION OF TI PRODUCTS IN SUCH APPLICATIONS IS UNDERSTOOD TO BE FULLY AT THE CUSTOMER'S RISK.

In order to minimize risks associated with the customer's applications, adequate design and operating safeguards must be provided by the customer to minimize inherent or procedural hazards.

TI assumes no liability for applications assistance or customer product design. TI does not warrant or represent that any license, either express or implied, is granted under any patent right, copyright, mask work right, or other intellectual property right of TI covering or relating to any combination, machine, or process in which such semiconductor products or services might be or are used. TI's publication of information regarding any third party's products or services does not constitute TI's approval, warranty or endorsement thereof.