

TPS2290x 3.6-V, 500-mA, 78-mΩ ON-Resistance Load Switch With Controlled Turnon

1 Features

- Integrated P-Channel Load Switch
- Low Input Voltage: 1 V to 3.6 V
- ON-Resistance (Typical Values)
 - $r_{ON} = 78 \text{ m}\Omega$ at $V_{IN} = 3.6 \text{ V}$
 - $r_{ON} = 93 \text{ m}\Omega$ at $V_{IN} = 2.5 \text{ V}$
 - $r_{ON} = 109 \text{ m}\Omega$ at $V_{IN} = 1.8 \text{ V}$
 - $r_{ON} = 146 \text{ m}\Omega$ at $V_{IN} = 1.2 \text{ V}$
- 500 mA Maximum Continuous Switch Current
- Quiescent Current: 82 nA at 1.8 V
- Shutdown Current: 44 nA at 1.8 V
- Low Control Input Thresholds Enable Use of 1.2-V, 1.8-V, 2.5-V, and 3.3-V Logic
- Controlled Slew Rate to Avoid Inrush Currents
 - $t_r = 40 \text{ }\mu\text{s}$ at $V_{IN} = 1.8 \text{ V}$ (TPS22901/2)
 - $t_r = 220 \text{ }\mu\text{s}$ at $V_{IN} = 1.8 \text{ V}$ (TPS22902B)
- Quick Output Discharge (TPS22902/2B)
- ESD Performance Tested Per JESD 22
 - 2000-V Human Body Model (A114-B, Class II)
 - 1000-V Charged-Device Model (C101)
- Four-Pin Wafer-Chip-Scale DSBGA Package
 - 0.8-mm × 0.8-mm, 0.4-mm Pitch, 0.5-mm Height (YFP)

2 Applications

- Personal Digital Assistants (PDAs)
- Cellular Phones
- GPS Devices
- MP3 Players
- Digital Cameras
- Peripheral Ports
- Portable Instrumentation
- RF Modules

3 Description

The TPS22901, TPS22902, and TPS22902B are small, low ON-resistance (r_{ON}) load switches with a controlled turnon. These devices contain a P-channel MOSFET that operates over an input voltage range of 1.0 V to 3.6 V. The switch is controlled by an on/off input (ON), which can interface directly with low-voltage control signals. In the TPS22902 and TPS22902B, an 88-Ω on-chip load resistor is added for output quick discharge when the switch is turned off.

The TPS22901, TPS22902, and TPS22902B are available in a space-saving 4-pin DSBGA (YFP) with 0.4-mm pitch. These devices are characterized for operation over the free-air temperature range of -40°C to 85°C .

Device Information⁽¹⁾

PART NUMBER	PACKAGE	BODY SIZE (NOM)
TPS22901	DSBGA (4)	0.80 mm × 0.80 mm
TPS22902		
TPS22902B		

(1) For all available packages, see the orderable addendum at the end of the data sheet.

4 Typical Application Schematic

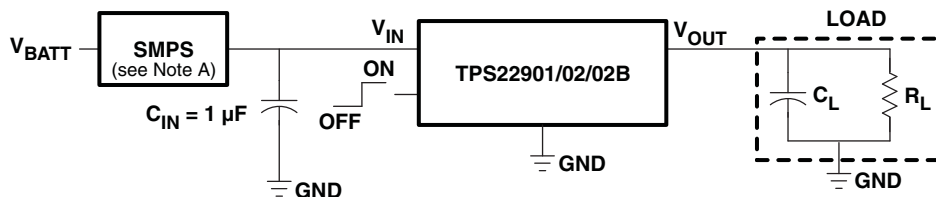

A. Switched-mode power supply



Table of Contents

1 Features	1	9 Parameter Measurement Information	19
2 Applications	1	10 Detailed Description	20
3 Description	1	10.1 Overview	20
4 Typical Application Schematic	1	10.2 Functional Block Diagram	20
5 Revision History	2	10.3 Feature Description	20
6 Device Comparison Table	3	10.4 Device Functional Modes	20
7 Pin Configuration and Functions	3	11 Application and Implementation	21
8 Specifications	4	11.1 Application Information	21
8.1 Absolute Maximum Ratings	4	11.2 Typical Application	21
8.2 ESD Ratings	4	12 Power Supply Recommendations	24
8.3 Recommended Operating Conditions	4	13 Layout	24
8.4 Thermal Information	4	13.1 Layout Guidelines	24
8.5 Electrical Characteristics	5	13.2 Layout Example	24
8.6 Switching Characteristics ($V_{IN} = 1.1\text{ V}$)	6	14 Device and Documentation Support	25
8.7 Switching Characteristics ($V_{IN} = 1.2\text{ V}$)	6	14.1 Related Links	25
8.8 Switching Characteristics ($V_{IN} = 1.8\text{ V}$)	7	14.2 Trademarks	25
8.9 Switching Characteristics ($V_{IN} = 2.5\text{ V}$)	7	14.3 Electrostatic Discharge Caution	25
8.10 Switching Characteristics ($V_{IN} = 3.0\text{ V}$)	8	14.4 Glossary	25
8.11 Switching Characteristics ($V_{IN} = 3.6\text{ V}$)	8	15 Mechanical, Packaging, and Orderable Information	25
8.12 Typical DC Characteristics	9		

5 Revision History

NOTE: Page numbers for previous revisions may differ from page numbers in the current version.

Changes from Revision C (December 2012) to Revision D	Page
• Added <i>ESD Rating</i> table, <i>Feature Description</i> section, <i>Device Functional Modes</i> , <i>Application and Implementation</i> section, <i>Power Supply Recommendations</i> section, <i>Layout</i> section, <i>Device and Documentation Support</i> section, and <i>Mechanical, Packaging, and Orderable Information</i> section.	1
• Deleted the <i>ORDERING INFORMATION</i> table.	3

Changes from Revision B (March 2009) to Revision C	Page
• Changed the <i>ORDERING INFORMATION</i> table.	3

6 Device Comparison Table

	R _{ON} at 1.8 V (TYP)	RISE TIME (TYP at 1.8 V)	QUICK OUTPUT DISCHARGE ⁽¹⁾	MAX OUTPUT CURRENT	ENABLE
TPS22901	109 mΩ	40 μs	No	500 mA	Active high
TPS22902			Yes		
TPS22902B		220 μs	Yes		

(1) This feature discharges the output of the switch to ground through an 88 Ω resistor, preventing the output from floating.

7 Pin Configuration and Functions

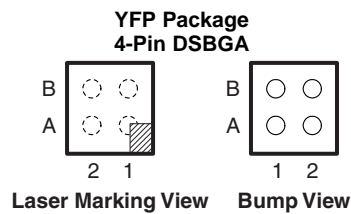

Pin Assignments

B	ON	GND
A	V _{IN}	V _{OUT}
	2	1

Pin Functions

PIN		I/O	DESCRIPTION
NO.	NAME		
A1	V _{OUT}	O	Switch output
A2	V _{IN}	I	Switch input, bypass this input with a ceramic capacitor to ground
B1	GND	-	Ground
B2	ON	I	Switch control input, active high

8 Specifications

8.1 Absolute Maximum Ratings

over operating free-air temperature range (unless otherwise noted)⁽¹⁾

		MIN	MAX	UNIT
V _{IN}	Input voltage	-0.3	4	V
V _{OUT}	Output voltage		V _{IN} + 0.3	V
V _{ON}	Input voltage	-0.3	4	V
P	Power dissipation at T _A = 25°C		0.48	W
I _{MAX}	Maximum continuous switch current		500	mA
T _A	Operating free-air temperature	-40	85	°C
T _{lead}	Maximum lead temperature (10-s soldering time)		300	°C
T _{stg}	Storage temperature	-65	150	°C

- (1) Stresses beyond those listed under *Absolute Maximum Ratings* may cause permanent damage to the device. These are stress ratings only, which do not imply functional operation of the device at these or any other conditions beyond those indicated under *Recommended Operating Conditions*. Exposure to absolute-maximum-rated conditions for extended periods may affect device reliability.

8.2 ESD Ratings

		VALUE	UNIT
V _(ESD)	Electrostatic discharge	Human body model (HBM), per ANSI/ESDA/JEDEC JS-001 ⁽¹⁾	±2000
		Charged-device model (CDM), per JEDEC specification JESD22-C101 ⁽²⁾	±1000
			V

- (1) JEDEC document JEP155 states that 500-V HBM allows safe manufacturing with a standard ESD control process.

- (2) JEDEC document JEP157 states that 250-V CDM allows safe manufacturing with a standard ESD control process.

8.3 Recommended Operating Conditions

		MIN	MAX	UNIT
V _{IN}	Input voltage	1	3.6	V
V _{OUT}	Output voltage		V _{IN}	V
V _{IH}	High-level input voltage, ON	0.85	3.6	V
V _{IL}	Low-level input voltage, ON		0.4	V
C _{IN}	Input capacitor	See ⁽¹⁾		µF

- (1) See *Input Capacitor (Optional)*.

8.4 Thermal Information

THERMAL METRIC ⁽¹⁾	TPS2290X	UNIT	
	YFP (DSBGA)		
	4 PINS		
R _{θJA}	Junction-to-ambient thermal resistance	192.1	°C/W
R _{θJC(top)}	Junction-to-case (top) thermal resistance	2.3	
R _{θJB}	Junction-to-board thermal resistance	35.8	
ψ _{JT}	Junction-to-top characterization parameter	11.8	
ψ _{JB}	Junction-to-board characterization parameter	35.6	

- (1) For more information about traditional and new thermal metrics, see the *IC Package Thermal Metrics* application report, [SPRA953](#).

8.5 Electrical Characteristics

$V_{IN} = 1.0\text{ V to }3.6\text{ V}$, $T_A = -40^\circ\text{C to }85^\circ\text{C}$ (unless otherwise noted). Typical values are for $T_A = 25^\circ\text{C}$

PARAMETER		TEST CONDITIONS	T_A	MIN	TYP	MAX	UNIT				
I_Q	Quiescent current	$I_{OUT} = 0$, $V_{IN} = V_{ON}$	$V_{IN} = 1.1\text{ V}$	Full	37	120	nA				
			$V_{IN} = 1.8\text{ V}$	Full	82	235					
			$V_{IN} = 3.6\text{ V}$	Full	204	880					
$I_{IN(OFF)}$	OFF-state supply current	$V_{ON} = \text{GND}$, $V_{OUT} = \text{Open}$	$V_{IN} = 1.1\text{ V}$	Full	22	210	nA				
			$V_{IN} = 1.8\text{ V}$	Full	44	260					
			$V_{IN} = 3.6\text{ V}$	Full	137	700					
$I_{IN(LEAKAGE)}$	OFF-state switch current	$V_{ON} = \text{GND}$, $V_{OUT} = 0\text{ V}$	$V_{IN} = 1.1\text{ V}$	Full	22	140	nA				
			$V_{IN} = 1.8\text{ V}$	Full	45	230					
			$V_{IN} = 3.6\text{ V}$	Full	137	610					
r_{ON}	ON-state resistance	$I_{OUT} = -200\text{ mA}$	$V_{IN} = 3.6\text{ V}$	25°C	78	95	m Ω				
				Full		95					
			$V_{IN} = 2.5\text{ V}$	25°C	93	110					
				Full		110					
			$V_{IN} = 1.8\text{ V}$	25°C	109	130					
				Full		130					
			$V_{IN} = 1.2\text{ V}$	25°C	146	200					
				Full		200					
			$V_{IN} = 1.1\text{ V}$	25°C	174	330					
				Full		330					
			r_{PD}	Output pulldown resistance	$V_{IN} = 3.3\text{ V}$, $V_{ON} = 0$, $I_{OUT} = 30\text{ mA}$ (TPS22902/TPS22902B only)	25°C			88	120	Ω
			I_{ON}	ON input leakage current	$V_{ON} = 1.1\text{ V to }3.6\text{ V or GND}$	Full				25	nA

8.6 Switching Characteristics ($V_{IN} = 1.1\text{ V}$)

 $V_{IN} = 1.1\text{ V}$, $T_A = 25^\circ\text{C}$ (unless otherwise noted)

PARAMETER	TEST CONDITIONS		TPS22901			TPS22902 ⁽¹⁾			TPS22902B ⁽¹⁾			UNIT
			MIN	TYP	MAX	MIN	TYP	MAX	MIN	TYP	MAX	
t_{ON} Turn-ON time	$R_L = 500\ \Omega$	$C_L = 0.1\ \mu\text{F}$	108			108			531			μs
		$C_L = 1\ \mu\text{F}$	131			131			596			
		$C_L = 3.3\ \mu\text{F}$	153			153			659			
t_{OFF} Turn-OFF time	$R_L = 500\ \Omega$	$C_L = 0.1\ \mu\text{F}$	39			11			11			μs
		$C_L = 1\ \mu\text{F}$	317			69			67			
		$C_L = 3.3\ \mu\text{F}$	1105			238			225			
t_r V_{OUT} rise time	$R_L = 500\ \Omega$	$C_L = 0.1\ \mu\text{F}$	70			70			365			μs
		$C_L = 1\ \mu\text{F}$	78			78			367			
		$C_L = 3.3\ \mu\text{F}$	92			92			395			
t_f V_{OUT} fall time	$R_L = 500\ \Omega$	$C_L = 0.1\ \mu\text{F}$	107			18			21			μs
		$C_L = 1\ \mu\text{F}$	966			175			189			
		$C_L = 3.3\ \mu\text{F}$	3532			632			565			

(1) Quick Output Discharge

8.7 Switching Characteristics ($V_{IN} = 1.2\text{ V}$)

 $V_{IN} = 1.2\text{ V}$, $T_A = 25^\circ\text{C}$ (unless otherwise noted)

PARAMETER	TEST CONDITIONS		TPS22901			TPS22902 ⁽¹⁾			TPS22902B ⁽¹⁾			UNIT
			MIN	TYP	MAX	MIN	TYP	MAX	MIN	TYP	MAX	
t_{ON} Turn-ON time	$R_L = 500\ \Omega$	$C_L = 0.1\ \mu\text{F}$	96			96			471			μs
		$C_L = 1\ \mu\text{F}$	116			116			527			
		$C_L = 3.3\ \mu\text{F}$	135			135			587			
t_{OFF} Turn-OFF time	$R_L = 500\ \Omega$	$C_L = 0.1\ \mu\text{F}$	39			10			10			μs
		$C_L = 1\ \mu\text{F}$	317			62			61			
		$C_L = 3.3\ \mu\text{F}$	1110			210			199			
t_r V_{OUT} rise time	$R_L = 500\ \Omega$	$C_L = 0.1\ \mu\text{F}$	62			62			324			μs
		$C_L = 1\ \mu\text{F}$	69			69			325			
		$C_L = 3.3\ \mu\text{F}$	81			81			350			
t_f V_{OUT} fall time	$R_L = 500\ \Omega$	$C_L = 0.1\ \mu\text{F}$	109			17			20			μs
		$C_L = 1\ \mu\text{F}$	995			163			175			
		$C_L = 3.3\ \mu\text{F}$	3650			587			523			

(1) Quick Output Discharge

8.8 Switching Characteristics ($V_{IN} = 1.8\text{ V}$)

 $V_{IN} = 1.8\text{ V}$, $T_A = 25^\circ\text{C}$ (unless otherwise noted)

PARAMETER	TEST CONDITIONS		TPS22901			TPS22902 ⁽¹⁾			TPS22902B ⁽¹⁾			UNIT
			MIN	TYP	MAX	MIN	TYP	MAX	MIN	TYP	MAX	
t_{ON} Turn-ON time	$R_L = 500\ \Omega$	$C_L = 0.1\ \mu\text{F}$	61			61			302			μs
		$C_L = 1\ \mu\text{F}$	72			72			335			
		$C_L = 3.3\ \mu\text{F}$	83			83			367			
t_{OFF} Turn-OFF time	$R_L = 500\ \Omega$	$C_L = 0.1\ \mu\text{F}$	38			8			8			μs
		$C_L = 1\ \mu\text{F}$	317			49			49			
		$C_L = 3.3\ \mu\text{F}$	1135			169			167			
t_r V_{OUT} rise time	$R_L = 500\ \Omega$	$C_L = 0.1\ \mu\text{F}$	40			40			220			μs
		$C_L = 1\ \mu\text{F}$	45			45			220			
		$C_L = 3.3\ \mu\text{F}$	53			53			235			
t_f V_{OUT} fall time	$R_L = 500\ \Omega$	$C_L = 0.1\ \mu\text{F}$	111			15			15			μs
		$C_L = 1\ \mu\text{F}$	1020			140			159			
		$C_L = 3.3\ \mu\text{F}$	3700			517			481			

(1) Quick Output Discharge

8.9 Switching Characteristics ($V_{IN} = 2.5\text{ V}$)

 $V_{IN} = 2.5\text{ V}$, $T_A = 25^\circ\text{C}$ (unless otherwise noted)

PARAMETER	TEST CONDITIONS		TPS22901			TPS22902 ⁽¹⁾			TPS22902B ⁽¹⁾			UNIT
			MIN	TYP	MAX	MIN	TYP	MAX	MIN	TYP	MAX	
t_{ON} Turn-ON time	$R_L = 500\ \Omega$	$C_L = 0.1\ \mu\text{F}$	45			45			223			μs
		$C_L = 1\ \mu\text{F}$	53			53			246			
		$C_L = 3.3\ \mu\text{F}$	61			61			268			
t_{OFF} Turn-OFF time	$R_L = 500\ \Omega$	$C_L = 0.1\ \mu\text{F}$	38			7			7			μs
		$C_L = 1\ \mu\text{F}$	314			46			47			
		$C_L = 3.3\ \mu\text{F}$	1140			161			158			
t_r V_{OUT} rise time	$R_L = 500\ \Omega$	$C_L = 0.1\ \mu\text{F}$	32			32			175			μs
		$C_L = 1\ \mu\text{F}$	35			35			175			
		$C_L = 3.3\ \mu\text{F}$	41			41			187			
t_f V_{OUT} fall time	$R_L = 500\ \Omega$	$C_L = 0.1\ \mu\text{F}$	113			14			18			μs
		$C_L = 1\ \mu\text{F}$	1040			139			185			
		$C_L = 3.3\ \mu\text{F}$	3795			516			471			

(1) Quick Output Discharge

8.10 Switching Characteristics ($V_{IN} = 3.0\text{ V}$)

 $V_{IN} = 3.0\text{ V}$, $T_A = 25^\circ\text{C}$ (unless otherwise noted)

PARAMETER	TEST CONDITIONS		TPS22901			TPS22902 ⁽¹⁾			TPS22902B ⁽¹⁾			UNIT
			MIN	TYP	MAX	MIN	TYP	MAX	MIN	TYP	MAX	
t_{ON} Turn-ON time	$R_L = 500\ \Omega$	$C_L = 0.1\ \mu\text{F}$	38			38			191			μs
		$C_L = 1\ \mu\text{F}$	45			45			211			
		$C_L = 3.3\ \mu\text{F}$	53			53			231			
t_{OFF} Turn-OFF time	$R_L = 500\ \Omega$	$C_L = 0.1\ \mu\text{F}$	38			7			7			μs
		$C_L = 1\ \mu\text{F}$	320			46			46			
		$C_L = 3.3\ \mu\text{F}$	1145			53			156			
t_r V_{OUT} rise time	$R_L = 500\ \Omega$	$C_L = 0.1\ \mu\text{F}$	28			28			159			μs
		$C_L = 1\ \mu\text{F}$	31			31			160			
		$C_L = 3.3\ \mu\text{F}$	37			37			170			
t_f V_{OUT} fall time	$R_L = 500\ \Omega$	$C_L = 0.1\ \mu\text{F}$	114			14			17			μs
		$C_L = 1\ \mu\text{F}$	1045			139			160			
		$C_L = 3.3\ \mu\text{F}$	3815			509			473			

(1) Quick Output Discharge

8.11 Switching Characteristics ($V_{IN} = 3.6\text{ V}$)

 $V_{IN} = 3.6\text{ V}$, $T_A = 25^\circ\text{C}$ (unless otherwise noted)

PARAMETER	TEST CONDITIONS		TPS22901			TPS22902 ⁽¹⁾			TPS22902B ⁽¹⁾			UNIT
			MIN	TYP	MAX	MIN	TYP	MAX	MIN	TYP	MAX	
t_{ON} Turn-ON time	$R_L = 500\ \Omega$	$C_L = 0.1\ \mu\text{F}$	33			33			166			μs
		$C_L = 1\ \mu\text{F}$	39			39			183			
		$C_L = 3.3\ \mu\text{F}$	46			46			201			
t_{OFF} Turn-OFF time	$R_L = 500\ \Omega$	$C_L = 0.1\ \mu\text{F}$	38			7			7			μs
		$C_L = 1\ \mu\text{F}$	322			46			45			
		$C_L = 3.3\ \mu\text{F}$	1145			156			155			
t_r V_{OUT} rise time	$R_L = 500\ \Omega$	$C_L = 0.1\ \mu\text{F}$	25			25			146			μs
		$C_L = 1\ \mu\text{F}$	28			28			146			
		$C_L = 3.3\ \mu\text{F}$	34			34			156			
t_f V_{OUT} fall time	$R_L = 500\ \Omega$	$C_L = 0.1\ \mu\text{F}$	116			14			17			μs
		$C_L = 1\ \mu\text{F}$	1060			139			161			
		$C_L = 3.3\ \mu\text{F}$	3840			512			475			

(1) Quick Output Discharge

8.12 Typical DC Characteristics

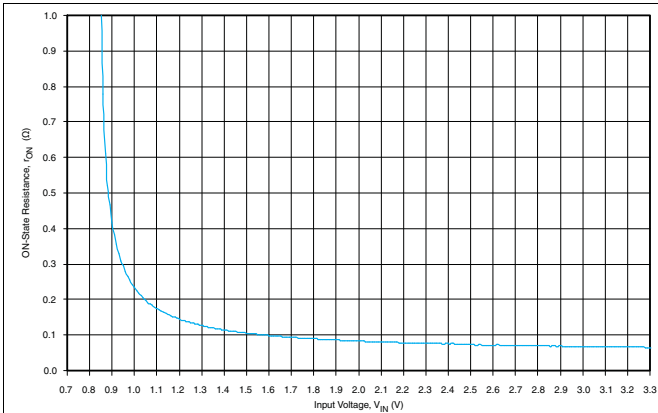

Figure 1. r_{ON} vs V_{IN}

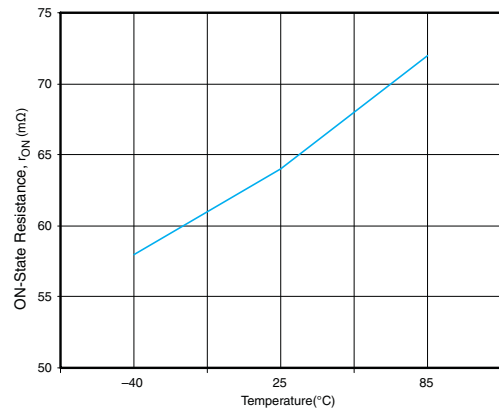

Figure 2. r_{ON} vs Temperature ($V_{IN} = 3.3$ V)

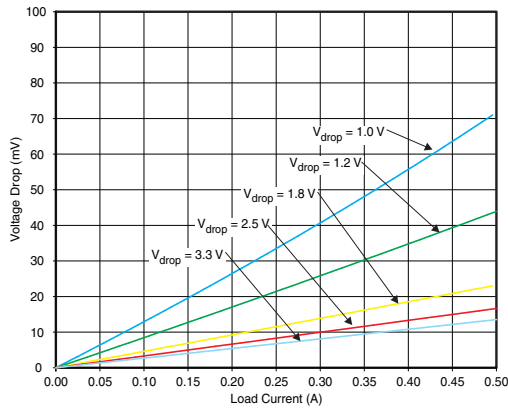

Figure 3. Voltage Drop vs. Load Current

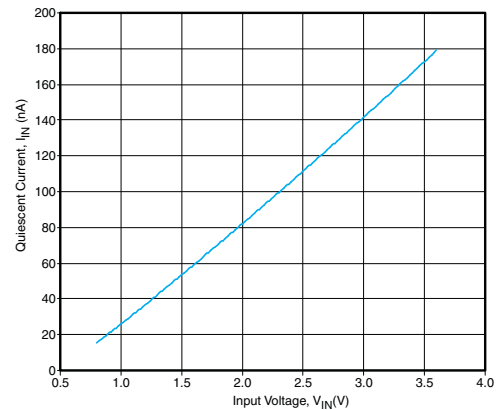

Figure 4. Quiescent Current vs V_{IN} ($V_{ON} = V_{IN}$, $I_{OUT} = 0$)

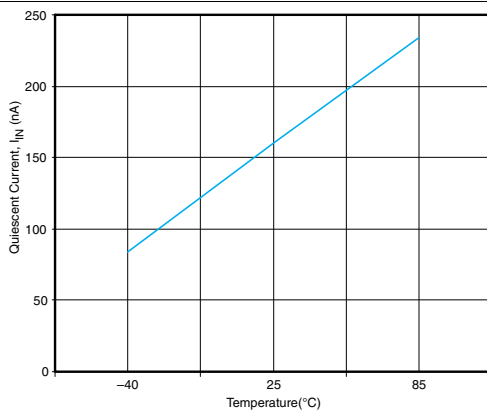

Figure 5. Quiescent Current vs Temperature ($V_{IN} = 3.3$ V, $I_{OUT} = 0$)

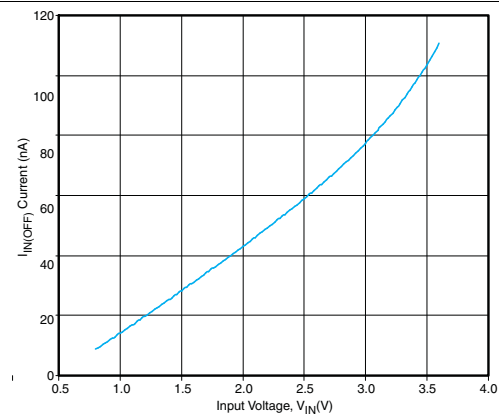

Figure 6. $I_{IN(OFF)}$ vs V_{IN} ($V_{ON} = 0$ V)

Typical DC Characteristics (continued)

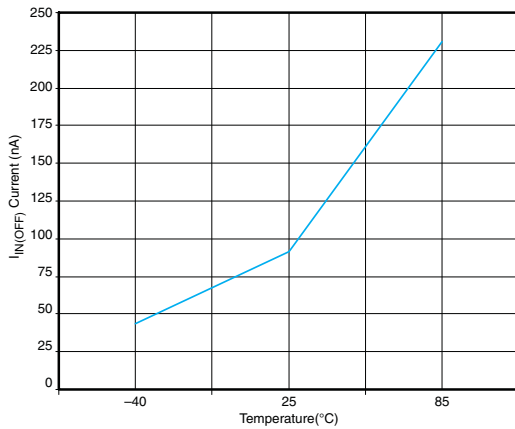

Figure 7. $I_{IN(OFF)}$ vs Temperature ($V_{IN} = 3.3$ V)

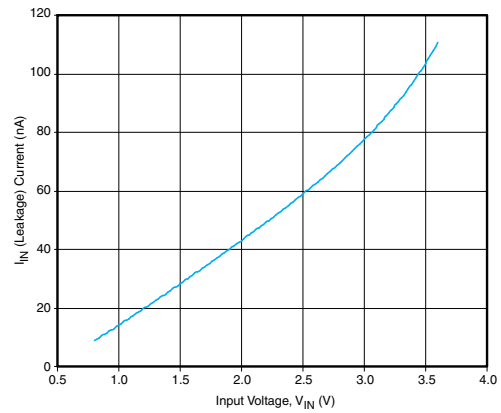

Figure 8. $I_{IN(Leakage)}$ vs V_{IN} ($I_{OUT} = 0$)

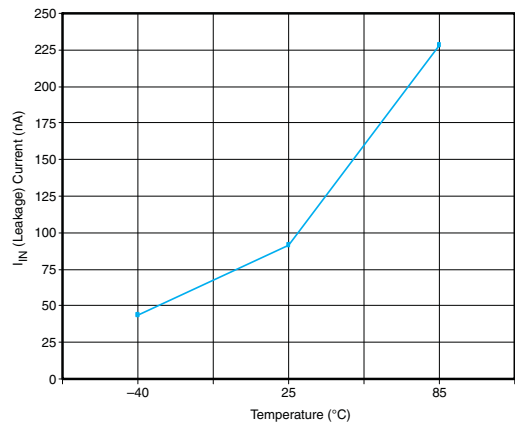

Figure 9. $I_{IN(Leakage)}$ vs Temperature ($V_{IN} = 3.3$ V)

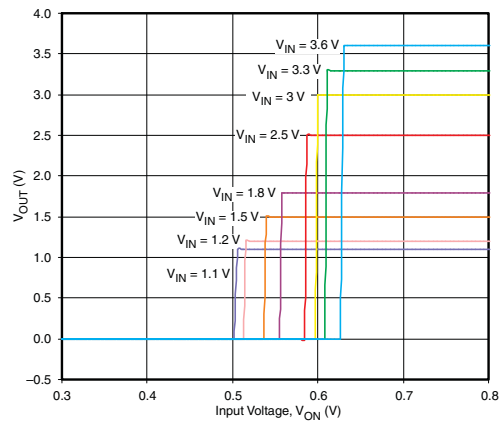
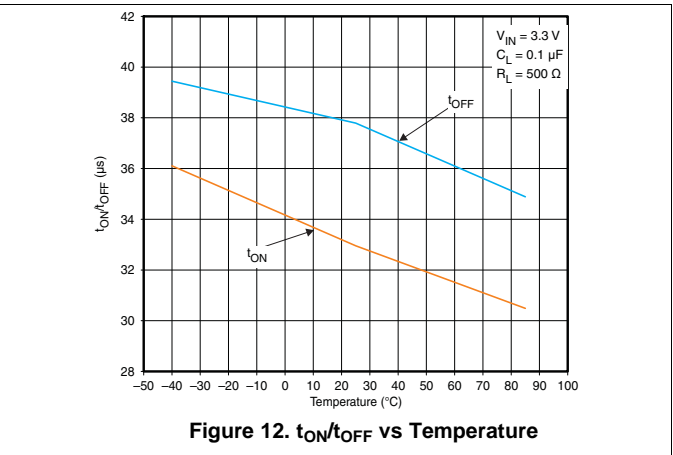
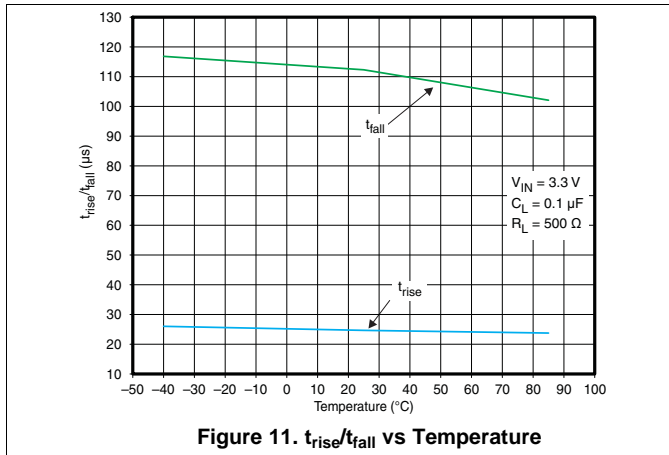

Figure 10. ON-Input Threshold

8.12.1 Typical AC Characteristics

8.12.1.1 TPS22901



8.12.1.2 TPS22902

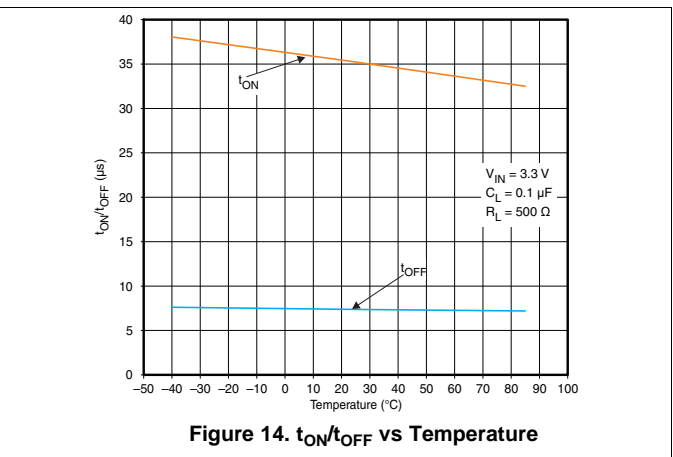
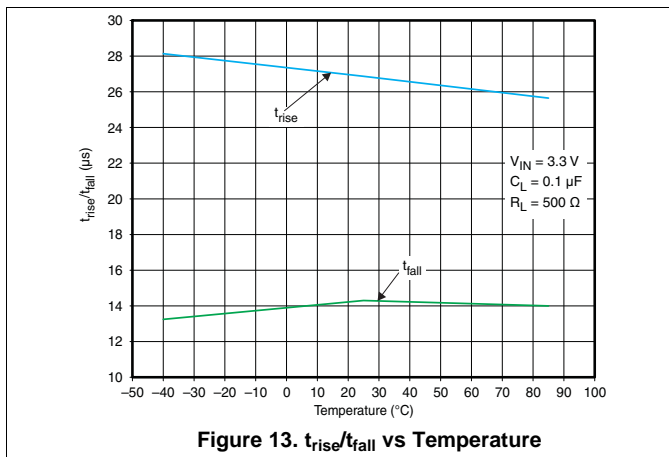

8.12.1.3 TPS22902B

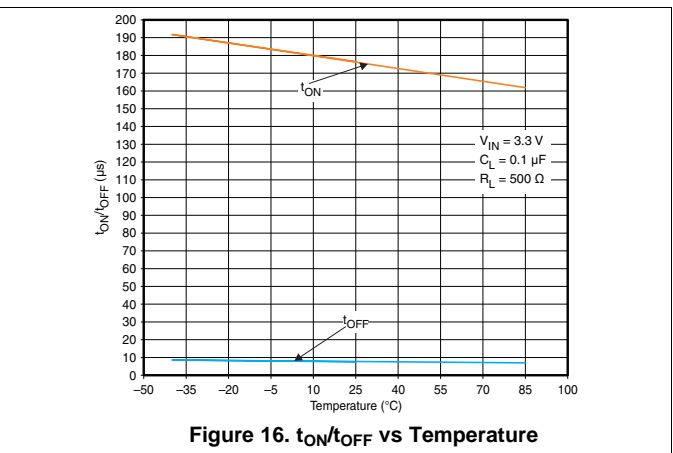
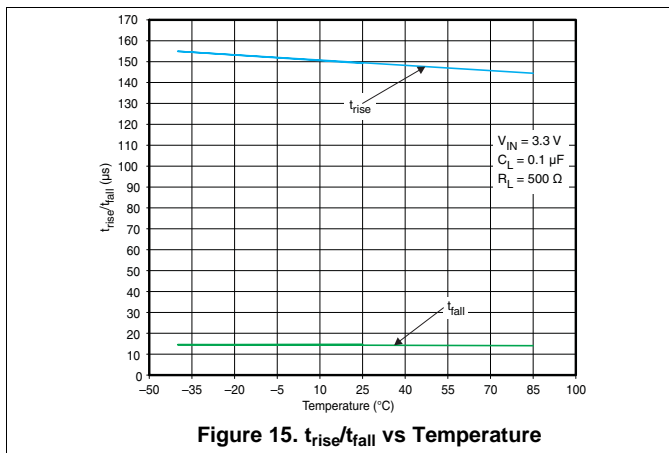

Typical AC Characteristics (continued)

8.12.1.4 TPS22901 and TPS22902

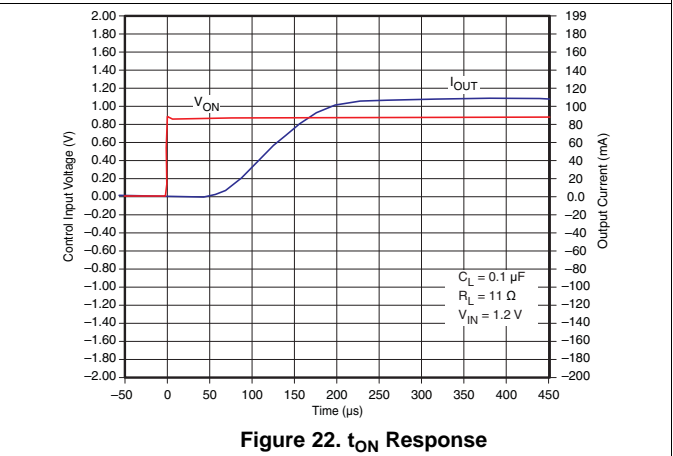
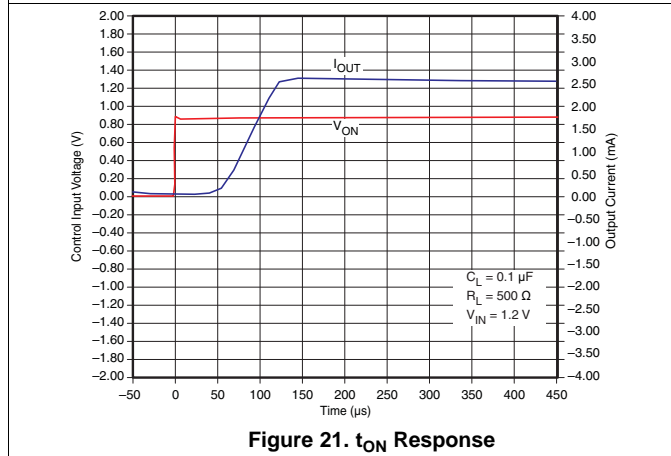
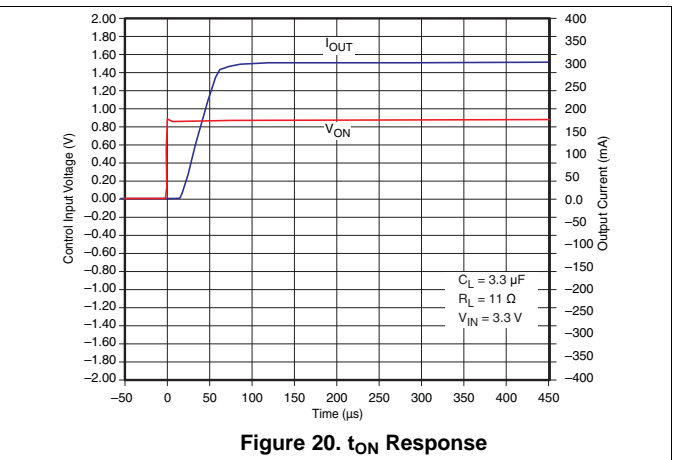
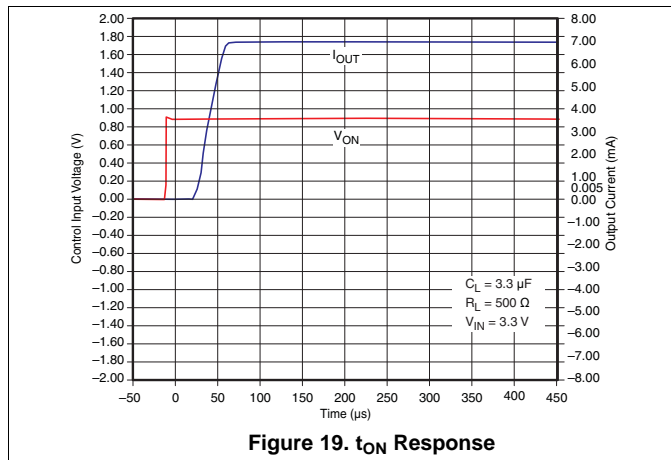
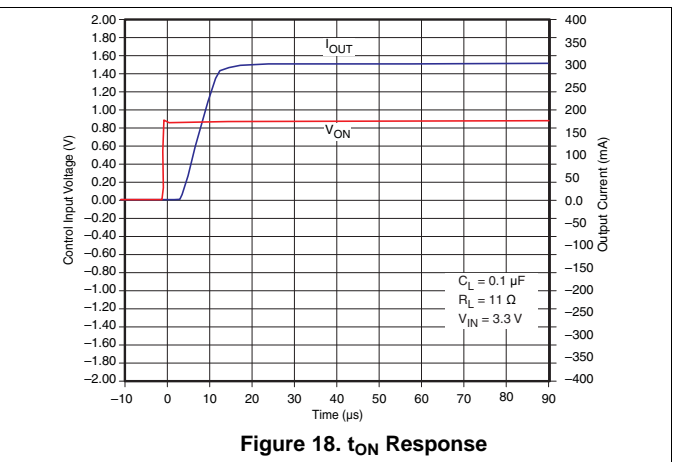
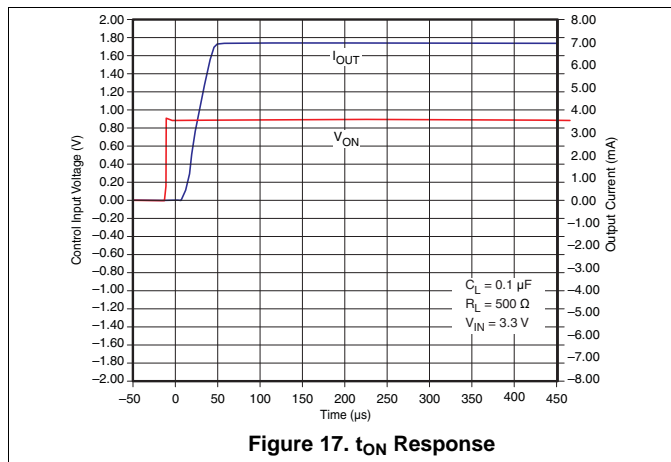

Typical AC Characteristics (continued)

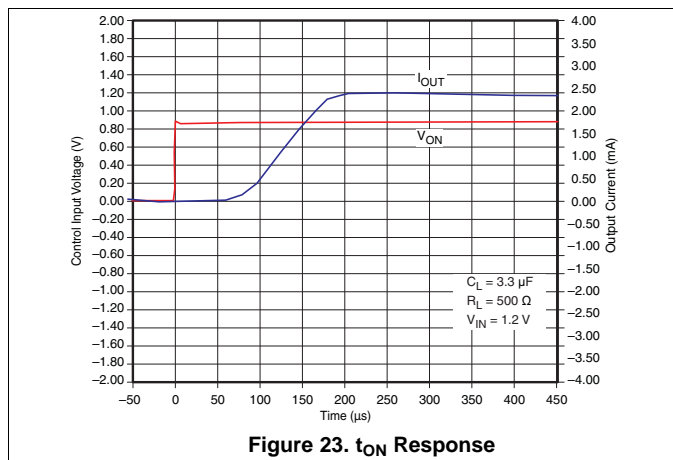

Figure 23. t_{ON} Response

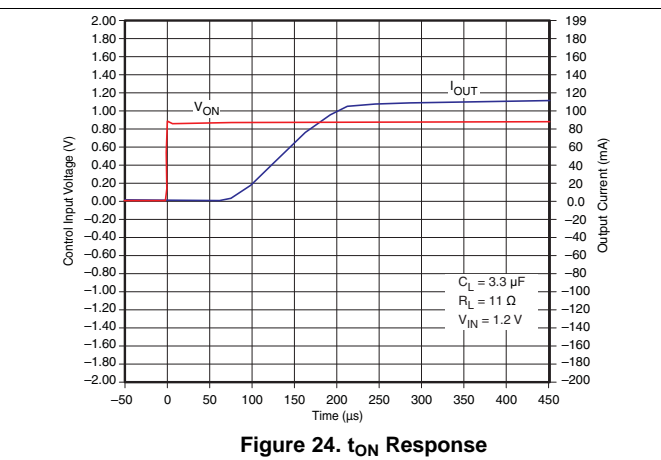

Figure 24. t_{ON} Response

8.12.1.5 TPS22901

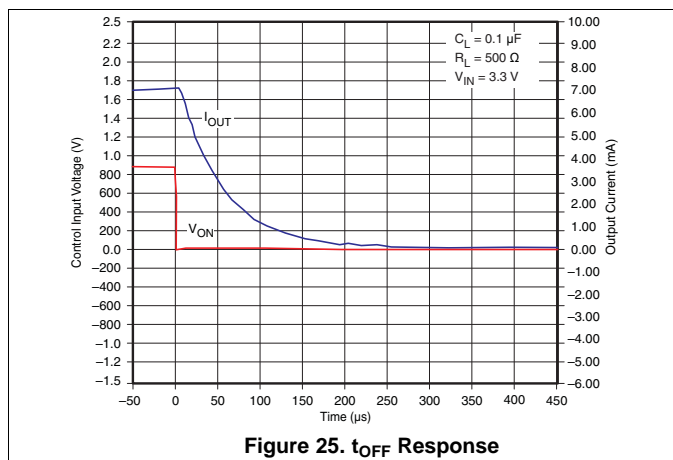

Figure 25. t_{OFF} Response

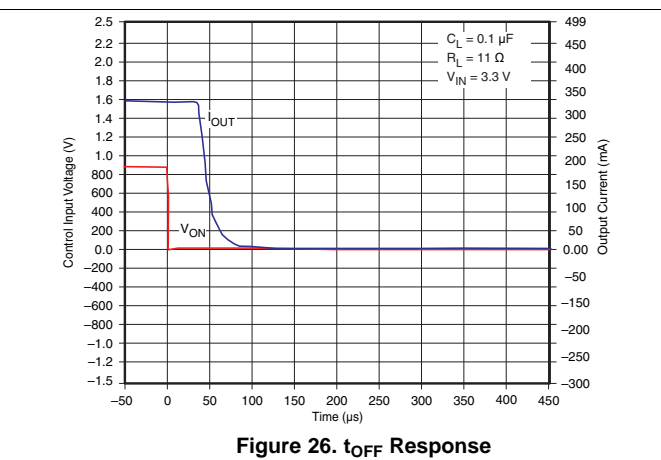

Figure 26. t_{OFF} Response

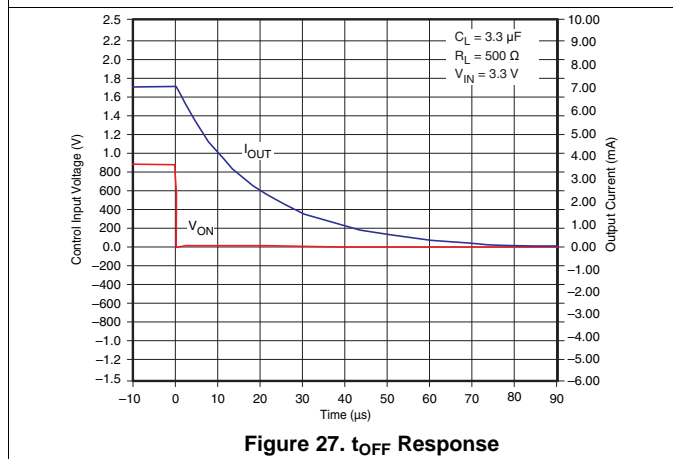

Figure 27. t_{OFF} Response

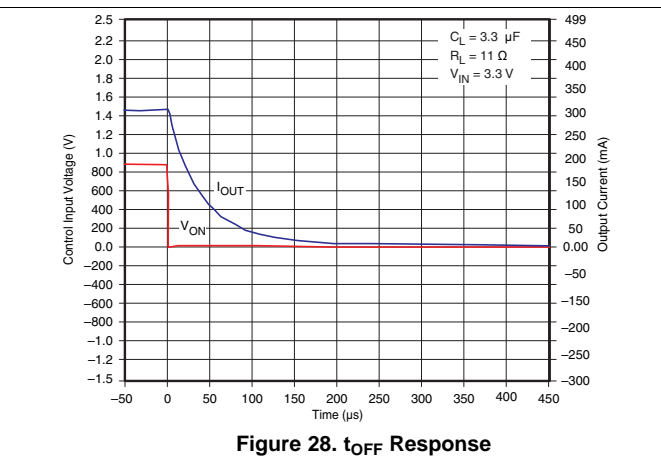

Figure 28. t_{OFF} Response

Typical AC Characteristics (continued)

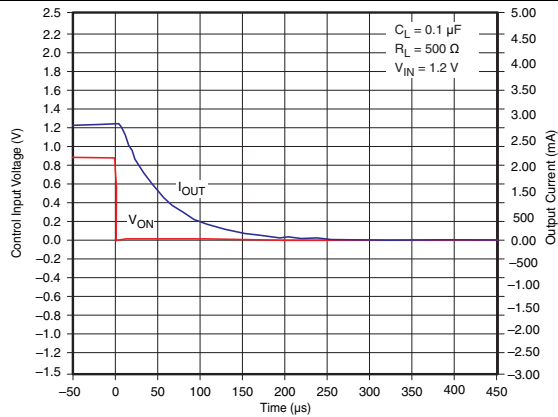

Figure 29. t_{OFF} Response

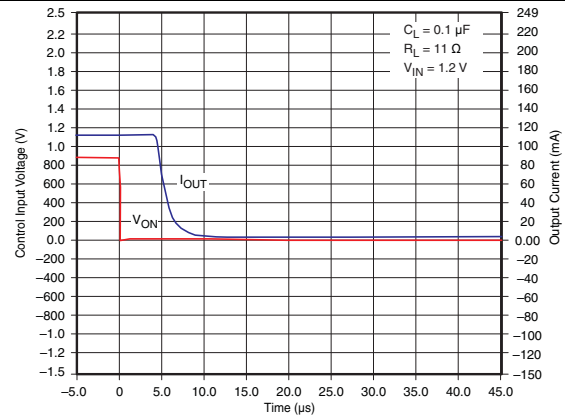

Figure 30. t_{OFF} Response

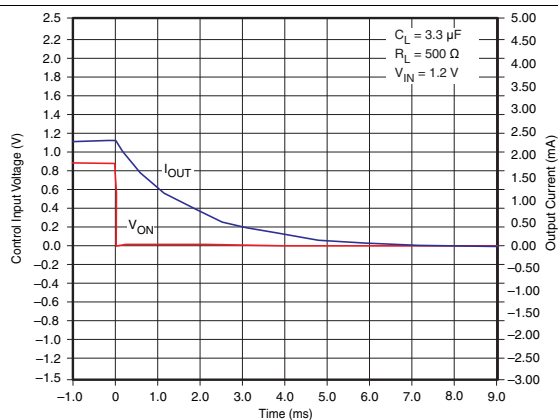

Figure 31. t_{OFF} Response

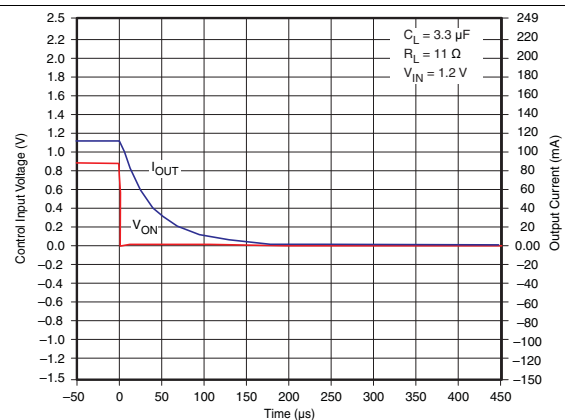

Figure 32. t_{OFF} Response

8.12.1.6 TPS22902

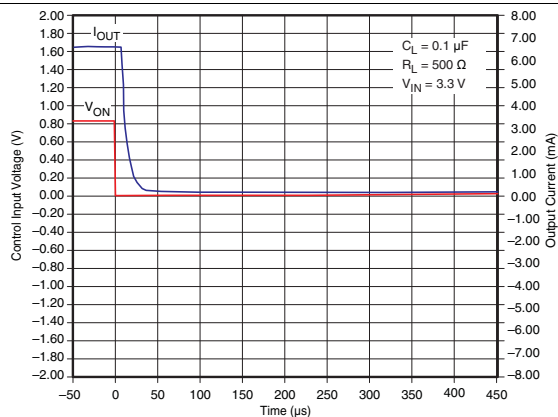

Figure 33. t_{OFF} Response

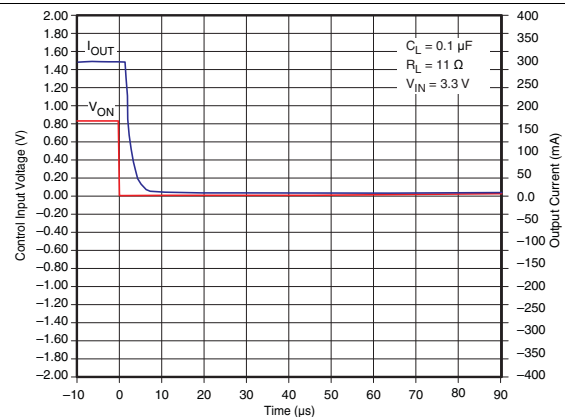

Figure 34. t_{OFF} Response

Typical AC Characteristics (continued)

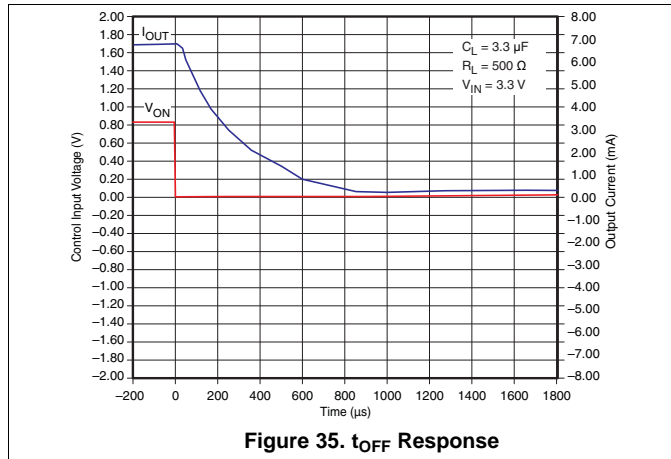

Figure 35. t_{OFF} Response

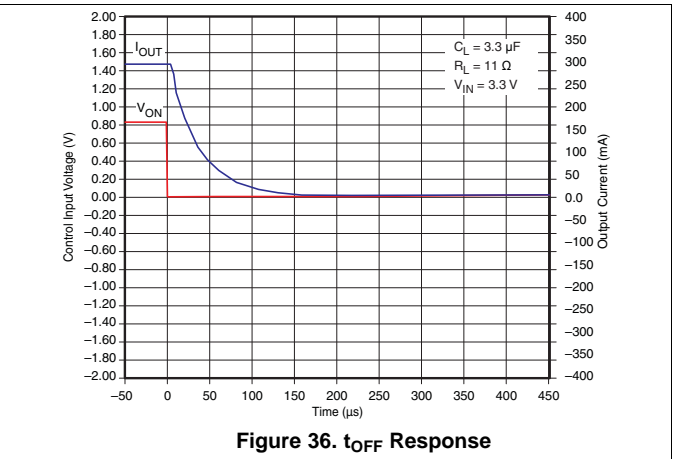

Figure 36. t_{OFF} Response

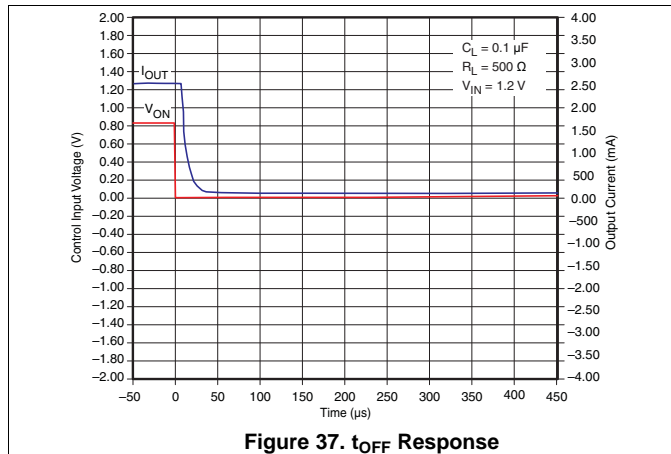

Figure 37. t_{OFF} Response

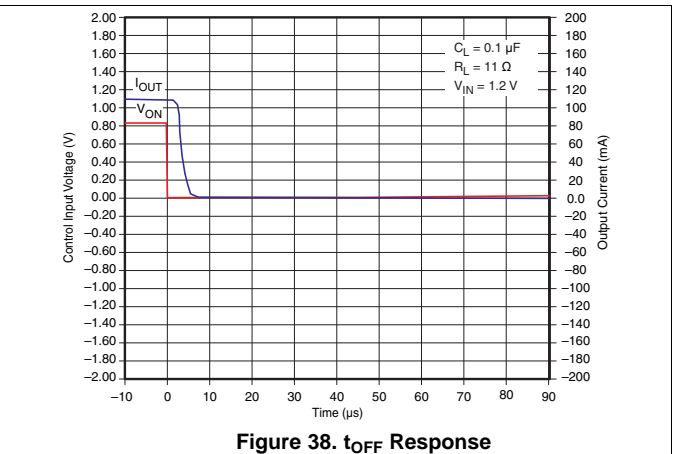

Figure 38. t_{OFF} Response

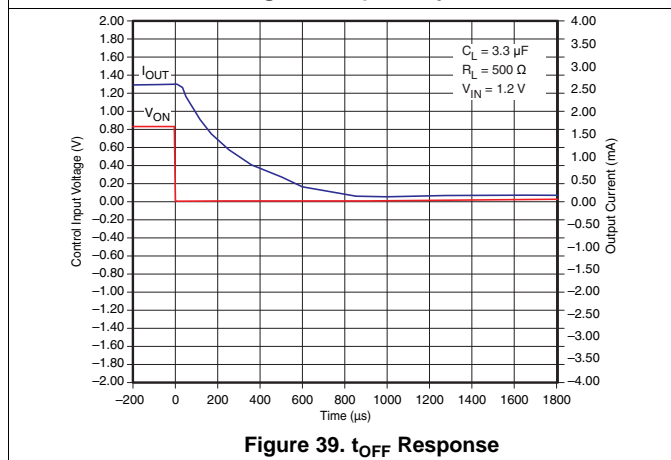

Figure 39. t_{OFF} Response

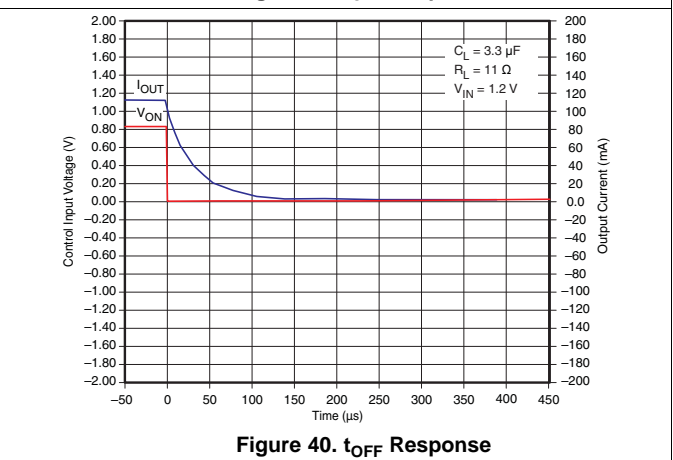

Figure 40. t_{OFF} Response

Typical AC Characteristics (continued)

8.12.1.7 TPS22902B

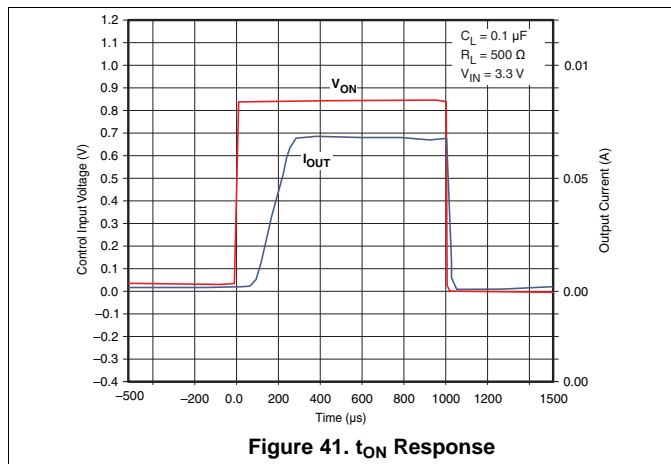

Figure 41. t_{ON} Response

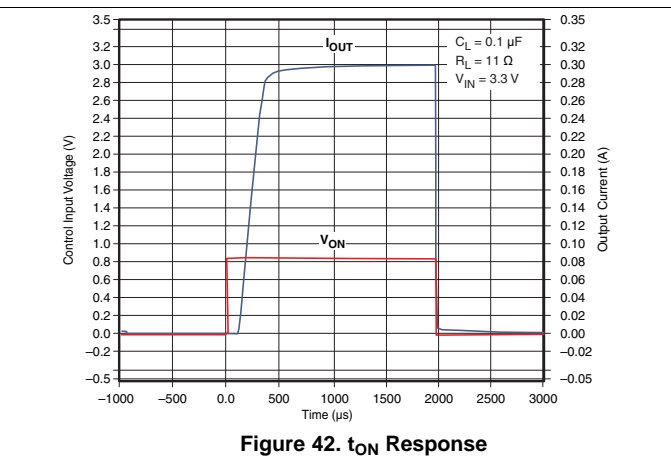

Figure 42. t_{ON} Response

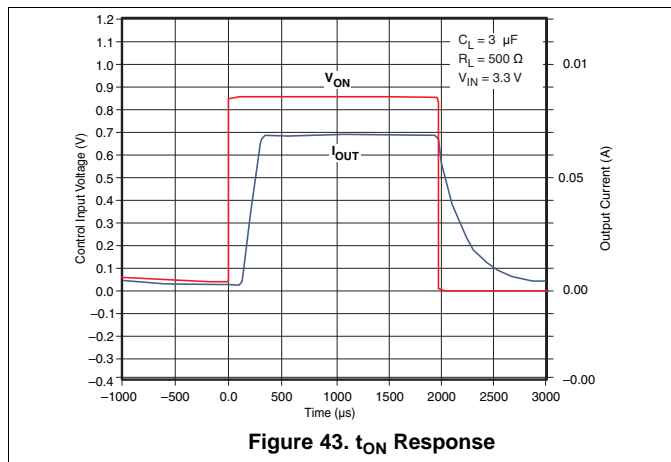

Figure 43. t_{ON} Response

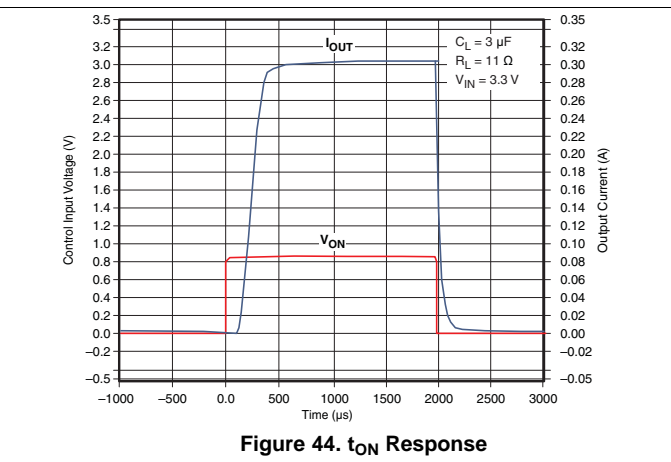

Figure 44. t_{ON} Response

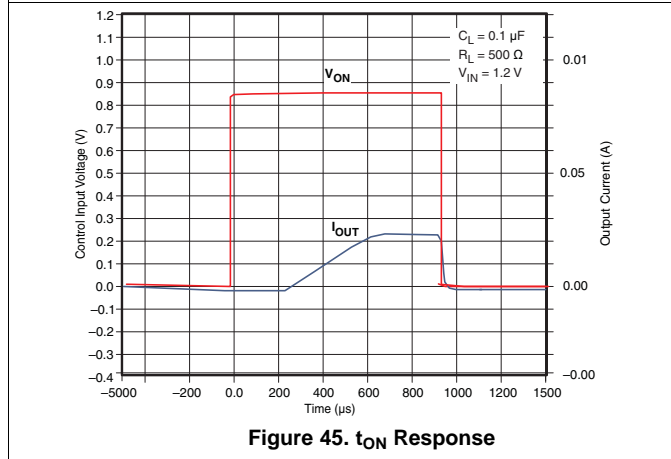

Figure 45. t_{ON} Response

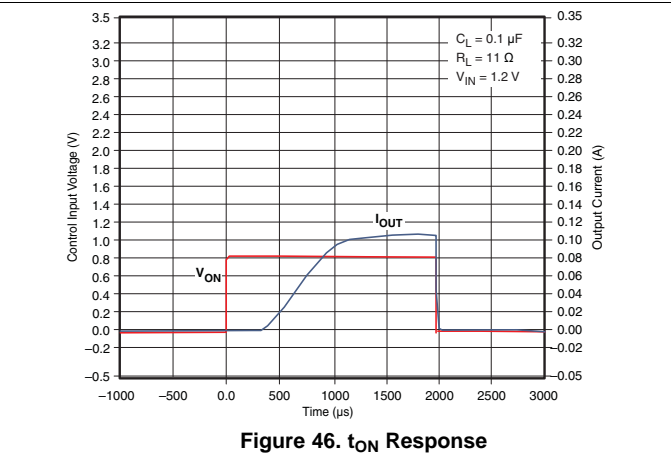

Figure 46. t_{ON} Response

Typical AC Characteristics (continued)

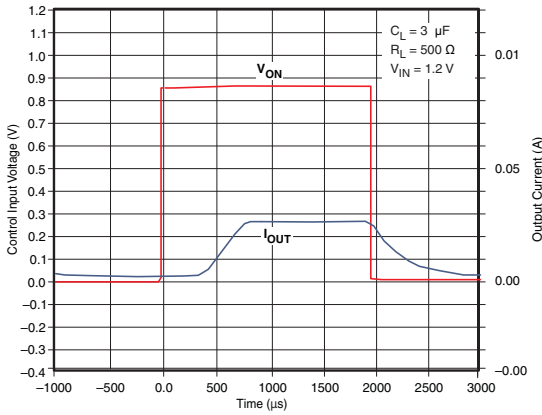

Figure 47. t_{ON} Response

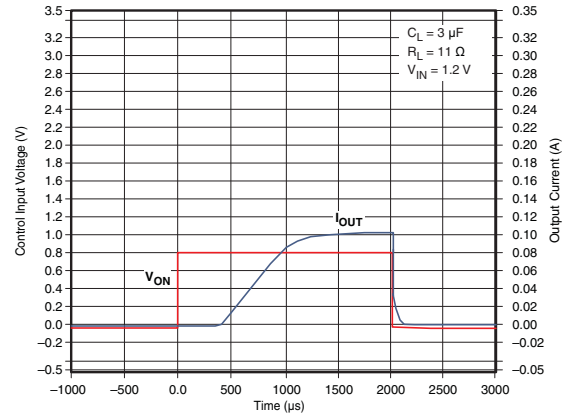

Figure 48. t_{ON} Response

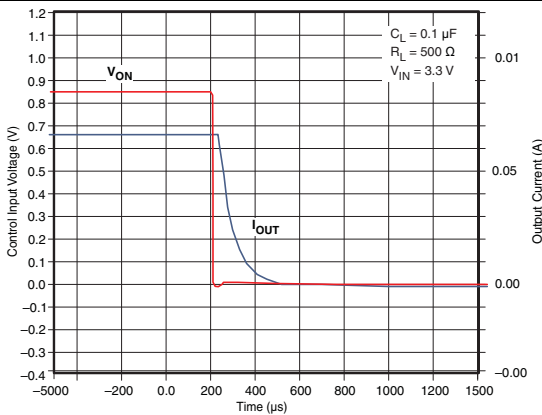

Figure 49. t_{OFF} Response

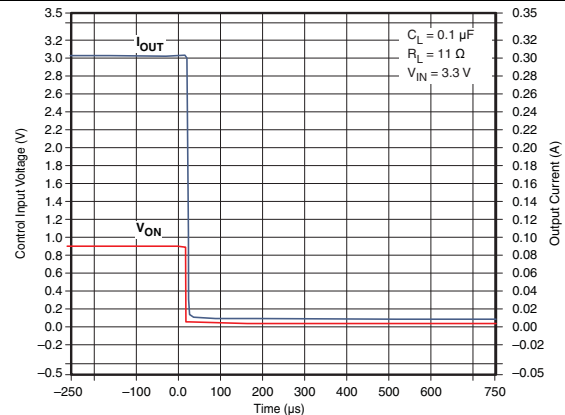

Figure 50. t_{OFF} Response

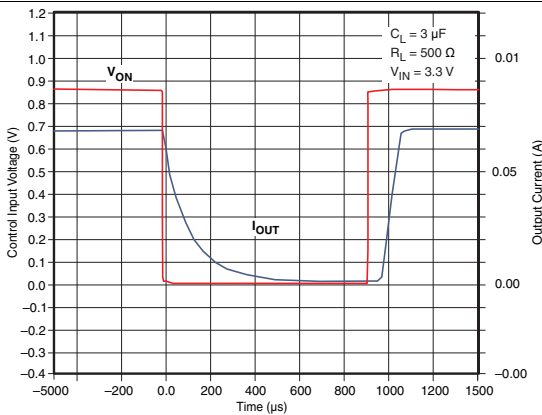

Figure 51. t_{OFF} Response

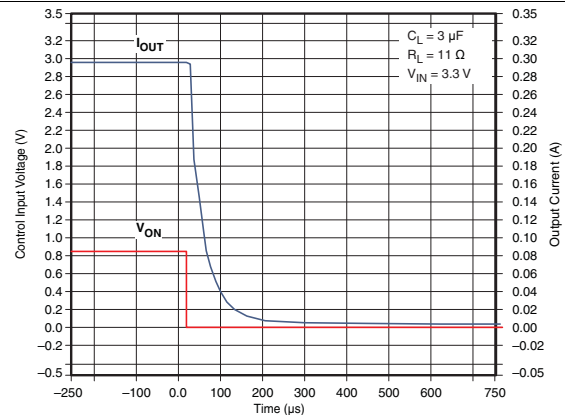
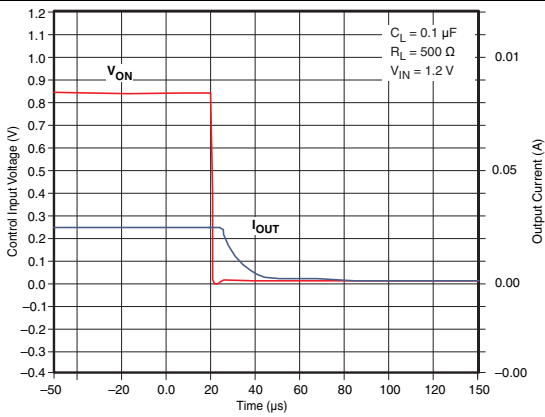
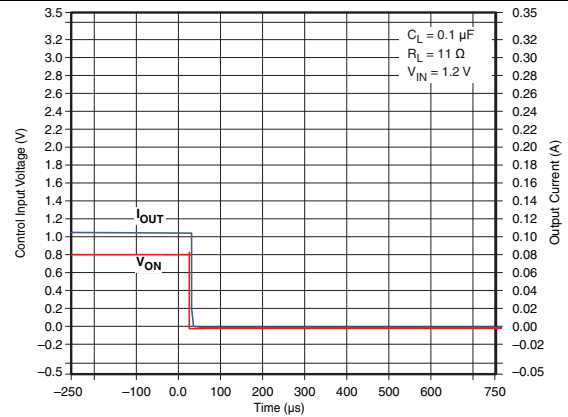
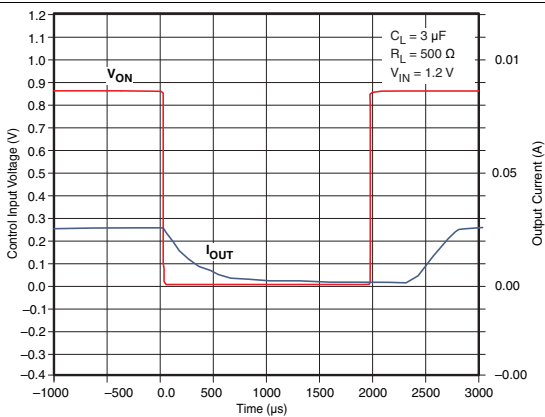
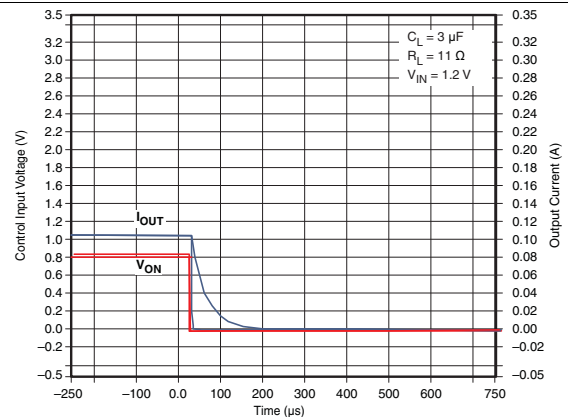
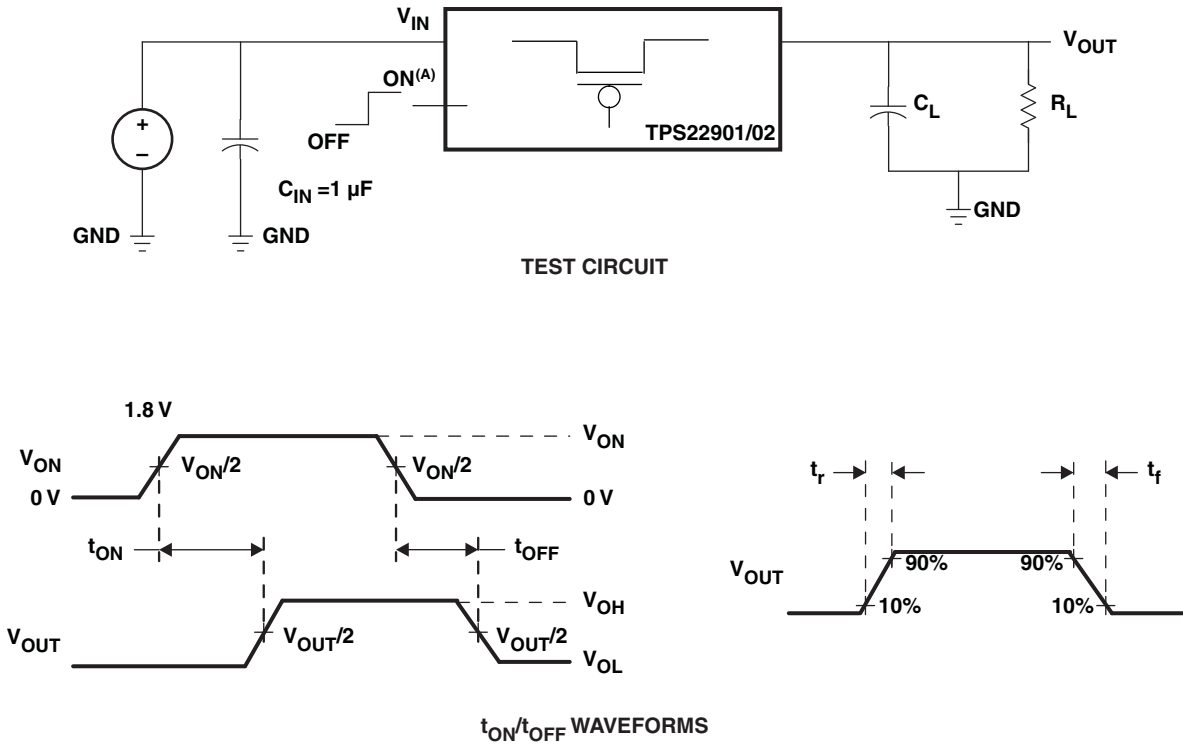

Figure 52. t_{OFF} Response

Typical AC Characteristics (continued)

Figure 53. t_{OFF} Response

Figure 54. t_{OFF} Response

Figure 55. t_{OFF} Response

Figure 56. t_{OFF} Response

9 Parameter Measurement Information



A. t_{rise} and t_{fall} of the control signal is 100 ns.

Figure 57. Test Circuit and t_{ON}/t_{OFF} Waveforms

10 Detailed Description

10.1 Overview

The TPS2290x and TPS22902B is a single channel, 500-mA load switch in a small, space-saving DSBGA-4 package. These devices implement a P-channel MOSFET to provide a low ON-resistance for a low voltage drop across the device. A controlled rise time is used in applications to limit the inrush current.

10.2 Functional Block Diagram

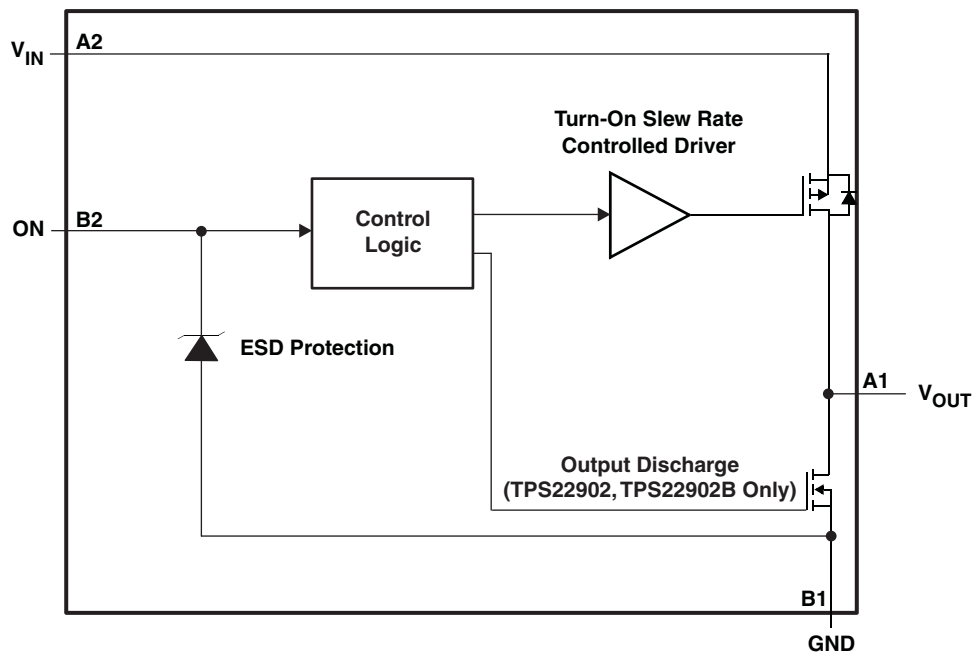

10.3 Feature Description

10.3.1 ON/OFF Control

The ON pin controls the state of the switch. Activating ON continuously holds the switch in the on state. ON is active-high and has a low threshold, making it capable of interfacing with low-voltage signals. The ON pin is compatible with standard GPIO logic threshold, and it can be used with any microcontroller with 1.2 V, 1.8 V, 2.5 V or 3.3 V GPIOs.

10.3.2 Quick Output Discharge

The TPS2290x and TPS22902B includes the Quick Output Discharge (QOD) feature. When the switch is disabled, a discharge resistance with a typical value of 88 Ω is connected between the output and ground. This resistance pulls down the output and prevents it from floating when the device is disabled.

10.4 Device Functional Modes

Table 1 lists the VOUT pin connections for a particular device as determined by the ON pin.

Table 1. VOUT Function Table

ON (Control Input)	TPS22901	TPS22902/2B
L	Open	GND
H	VIN	VIN

11 Application and Implementation

NOTE

Information in the following applications sections is not part of the TI component specification, and TI does not warrant its accuracy or completeness. TI's customers are responsible for determining suitability of components for their purposes. Customers should validate and test their design implementation to confirm system functionality.

11.1 Application Information

11.1.1 Input Capacitor (Optional)

To limit the voltage drop on the input supply caused by transient inrush currents when the switch turns on into a discharged load capacitor, a capacitor needs to be placed between V_{IN} and GND. A 1- μF ceramic capacitor, C_{IN} , placed close to the pins is usually sufficient. Higher values of C_{IN} can be used to further reduce the voltage drop during high current application. When switching heavy loads, TI recommends using an input capacitor about 10 times higher than the output capacitor in order to avoid excessive voltage drop.

11.1.2 Output Capacitor (Optional)

Because of the integral body diode in the PMOS switch, a C_{IN} greater than C_L is highly recommended. A C_L greater than C_{IN} can cause V_{OUT} to exceed V_{IN} when the system supply is removed. This could result in current flow through the body diode from V_{OUT} to V_{IN} .

11.2 Typical Application

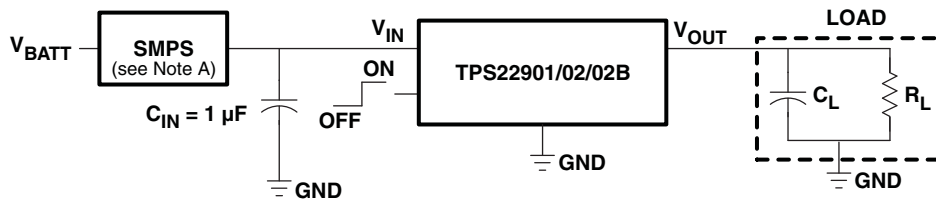

A. Switched-mode power supply

Figure 58. Typical Application Schematic

11.2.1 Design Requirements

Table 2. Design Parameters

DESIGN PARAMETER	EXAMPLE VALUE
V_{IN}	1.8 V
C_L	4.7 μF
Load current	500 mA
Ambient Temperature	25 °C
Maximum inrush current	200 mA

11.2.2 Detailed Design Procedure

11.2.2.1 Managing Inrush Current

When the switch is enabled, the output capacitors must be charged up from 0 V to the set value (1.8 V in this example). This charge arrives in the form of inrush current. Inrush current can be calculated using the following equation:

$$I_{\text{INRUSH}} = C_L \times \frac{dV_{\text{OUT}}}{dt}$$

where:

- C_L = Output capacitance
- dV_{OUT} = Output voltage
- dt = Rise time

(1)

The TPS2290x and TPS22902B offers a controlled rise time for minimizing inrush current. This device can be selected based upon the minimum acceptable rise time which can be calculated using the design requirements and the inrush current equation. An output capacitance of 4.7 μF will be used since the amount of inrush current increases with output capacitance:

$$200 \text{ mA} = 4.7 \mu\text{F} \times 1.8\text{V} / dt$$

$$dt = 42.3 \mu\text{s}$$

(2)

To ensure an inrush current of less than 200 mA, a device with a rise time greater than 42.3 μs must be used. The TPS22902B has a typical rise time of 220 μs at 1.8 V which meets the above design requirements. The TPS22901/2 has a faster rise time of 40 μs at 1.8 V, and this would result in an inrush current larger than desired.

11.2.2.2 VIN to VOUT Voltage Drop

The voltage drop from VIN to VOUT is determined by the ON-resistance of the device and the load current. R_{ON} can be found in [Electrical Characteristics](#) and is dependent on temperature. When the value of R_{ON} is found, the following equation can be used to calculate the voltage drop across the device:

$$\Delta V = I_{\text{LOAD}} \times R_{\text{ON}}$$

where:

- ΔV = Voltage drop across the device
- I_{LOAD} = Load current
- R_{ON} = ON-resistance of the device

(3)

At $V_{\text{IN}} = 1.8 \text{ V}$, the TPS22901/2/2B has an R_{ON} value of 109 m Ω . Using this value and the defined load current, the above equation can be evaluated:

$$\Delta V = 500 \text{ mA} \times 109 \text{ m}\Omega$$

$$\Delta V = 54.5 \text{ mV}$$

(4)

Therefore, the voltage drop across the device will be 54.5 mV.

11.2.3 Application Curve

Figure 59 shows the expected voltage drop across the device for different load currents and input voltages.

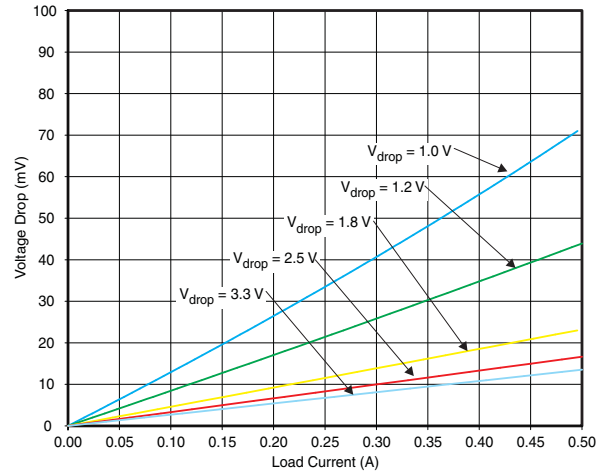

Figure 59. Voltage Drop vs Load Current

12 Power Supply Recommendations

The device is designed to operate with a V_{IN} range of 1 V to 3.6 V. This supply must be well regulated and placed as close to the device terminals as possible. It must also be able to withstand all transient and load currents, using a recommended input capacitance of 1 μF if necessary. If the supply is located more than a few inches from the device terminals, additional bulk capacitance may be required in addition to the ceramic bypass capacitors. If additional bulk capacitance is required, an electrolytic, tantalum, or ceramic capacitor of 10 μF may be sufficient.

13 Layout

13.1 Layout Guidelines

For best performance, V_{IN} , V_{OUT} , and GND traces should be as short and wide as possible to help minimize the parasitic electrical effects. To be most effective, the input and output capacitors should be placed close to the device to minimize the effects that parasitic trace inductances may have on normal operation.

For higher reliability, the maximum IC junction temperature, $T_{J(\text{max})}$, should be restricted to 125°C under normal operating conditions. Junction temperature is directly proportional to power dissipation in the device and the two are related by

$$T_J = T_A + \theta_{JA} \times P_D$$

where:

- T_J = Junction temperature of the device
- T_A = Ambient temperature
- P_D = Power dissipation inside the device
- θ_{JA} = Junction to ambient thermal resistance. See Thermal Information section of the datasheet. This parameter is highly dependent on board layout.

(5)

13.2 Layout Example

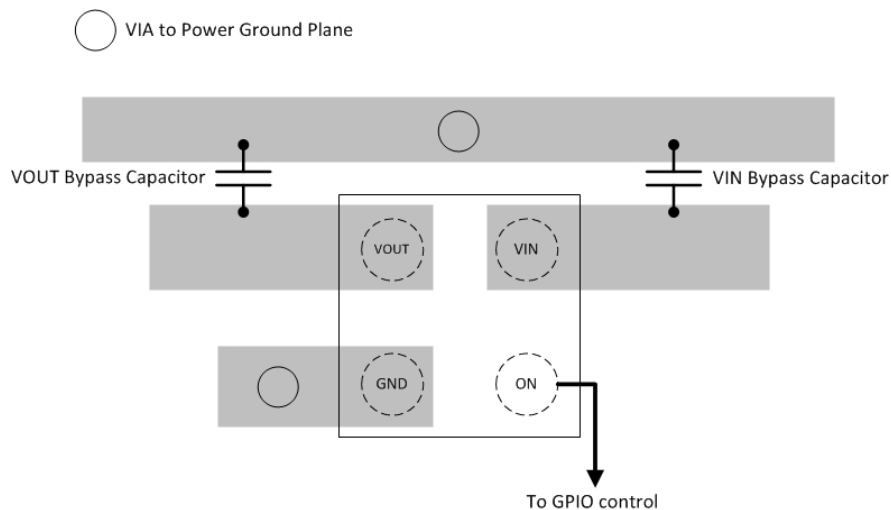

Figure 60. Layout Example Schematic

14 Device and Documentation Support

14.1 Related Links

The table below lists quick access links. Categories include technical documents, support and community resources, tools and software, and quick access to sample or buy.

Table 3. Related Links

PARTS	PRODUCT FOLDER	SAMPLE & BUY	TECHNICAL DOCUMENTS	TOOLS & SOFTWARE	SUPPORT & COMMUNITY
TPS22901	Click here	Click here	Click here	Click here	Click here
TPS22902	Click here	Click here	Click here	Click here	Click here
TPS22902B	Click here	Click here	Click here	Click here	Click here

14.2 Trademarks

All trademarks are the property of their respective owners.

14.3 Electrostatic Discharge Caution



These devices have limited built-in ESD protection. The leads should be shorted together or the device placed in conductive foam during storage or handling to prevent electrostatic damage to the MOS gates.

14.4 Glossary

[SLYZ022](#) — *TI Glossary*.

This glossary lists and explains terms, acronyms, and definitions.

15 Mechanical, Packaging, and Orderable Information

The following pages include mechanical, packaging, and orderable information. This information is the most current data available for the designated devices. This data is subject to change without notice and revision of this document. For browser-based versions of this data sheet, refer to the left-hand navigation.

PACKAGING INFORMATION

Orderable Device	Status (1)	Package Type	Package Drawing	Pins	Package Qty	Eco Plan (2)	Lead/Ball Finish (6)	MSL Peak Temp (3)	Op Temp (°C)	Device Marking (4/5)	Samples
TPS22901YFPR	ACTIVE	DSBGA	YFP	4	3000	Green (RoHS & no Sb/Br)	SNAGCU	Level-1-260C-UNLIM	-40 to 85	3P (3 ~ 5)	Samples
TPS22902BYFPR	ACTIVE	DSBGA	YFP	4	3000	Green (RoHS & no Sb/Br)	SNAGCU	Level-1-260C-UNLIM	-40 to 85	3S 3	Samples
TPS22902YFPR	ACTIVE	DSBGA	YFP	4	3000	Green (RoHS & no Sb/Br)	SNAGCU	Level-1-260C-UNLIM	-40 to 85	3R	Samples

(1) The marketing status values are defined as follows:

ACTIVE: Product device recommended for new designs.

LIFEBUY: TI has announced that the device will be discontinued, and a lifetime-buy period is in effect.

NRND: Not recommended for new designs. Device is in production to support existing customers, but TI does not recommend using this part in a new design.

PREVIEW: Device has been announced but is not in production. Samples may or may not be available.

OBsolete: TI has discontinued the production of the device.

(2) Eco Plan - The planned eco-friendly classification: Pb-Free (RoHS), Pb-Free (RoHS Exempt), or Green (RoHS & no Sb/Br) - please check <http://www.ti.com/productcontent> for the latest availability information and additional product content details.

TBD: The Pb-Free/Green conversion plan has not been defined.

Pb-Free (RoHS): TI's terms "Lead-Free" or "Pb-Free" mean semiconductor products that are compatible with the current RoHS requirements for all 6 substances, including the requirement that lead not exceed 0.1% by weight in homogeneous materials. Where designed to be soldered at high temperatures, TI Pb-Free products are suitable for use in specified lead-free processes.

Pb-Free (RoHS Exempt): This component has a RoHS exemption for either 1) lead-based flip-chip solder bumps used between the die and package, or 2) lead-based die adhesive used between the die and leadframe. The component is otherwise considered Pb-Free (RoHS compatible) as defined above.

Green (RoHS & no Sb/Br): TI defines "Green" to mean Pb-Free (RoHS compatible), and free of Bromine (Br) and Antimony (Sb) based flame retardants (Br or Sb do not exceed 0.1% by weight in homogeneous material)

(3) MSL, Peak Temp. - The Moisture Sensitivity Level rating according to the JEDEC industry standard classifications, and peak solder temperature.

(4) There may be additional marking, which relates to the logo, the lot trace code information, or the environmental category on the device.

(5) Multiple Device Markings will be inside parentheses. Only one Device Marking contained in parentheses and separated by a "~" will appear on a device. If a line is indented then it is a continuation of the previous line and the two combined represent the entire Device Marking for that device.

(6) Lead/Ball Finish - Orderable Devices may have multiple material finish options. Finish options are separated by a vertical ruled line. Lead/Ball Finish values may wrap to two lines if the finish value exceeds the maximum column width.

Important Information and Disclaimer: The information provided on this page represents TI's knowledge and belief as of the date that it is provided. TI bases its knowledge and belief on information provided by third parties, and makes no representation or warranty as to the accuracy of such information. Efforts are underway to better integrate information from third parties. TI has taken and

continues to take reasonable steps to provide representative and accurate information but may not have conducted destructive testing or chemical analysis on incoming materials and chemicals. TI and TI suppliers consider certain information to be proprietary, and thus CAS numbers and other limited information may not be available for release.

In no event shall TI's liability arising out of such information exceed the total purchase price of the TI part(s) at issue in this document sold by TI to Customer on an annual basis.

TAPE AND REEL INFORMATION



QUADRANT ASSIGNMENTS FOR PIN 1 ORIENTATION IN TAPE



*All dimensions are nominal

Device	Package Type	Package Drawing	Pins	SPQ	Reel Diameter (mm)	Reel Width W1 (mm)	A0 (mm)	B0 (mm)	K0 (mm)	P1 (mm)	W (mm)	Pin1 Quadrant
TPS22901YFPR	DSBGA	YFP	4	3000	178.0	9.2	0.89	0.89	0.58	4.0	8.0	Q1
TPS22902BYFPR	DSBGA	YFP	4	3000	180.0	8.4	0.89	0.89	0.58	4.0	8.0	Q1
TPS22902YFPR	DSBGA	YFP	4	3000	178.0	9.2	0.89	0.89	0.58	4.0	8.0	Q1
TPS22902YFPR	DSBGA	YFP	4	3000	180.0	8.4	0.89	0.89	0.58	4.0	8.0	Q1

TAPE AND REEL BOX DIMENSIONS

*All dimensions are nominal

Device	Package Type	Package Drawing	Pins	SPQ	Length (mm)	Width (mm)	Height (mm)
TPS22901YFPR	DSBGA	YFP	4	3000	220.0	220.0	35.0
TPS22902BYFPR	DSBGA	YFP	4	3000	182.0	182.0	20.0
TPS22902YFPR	DSBGA	YFP	4	3000	270.0	225.0	227.0
TPS22902YFPR	DSBGA	YFP	4	3000	182.0	182.0	20.0

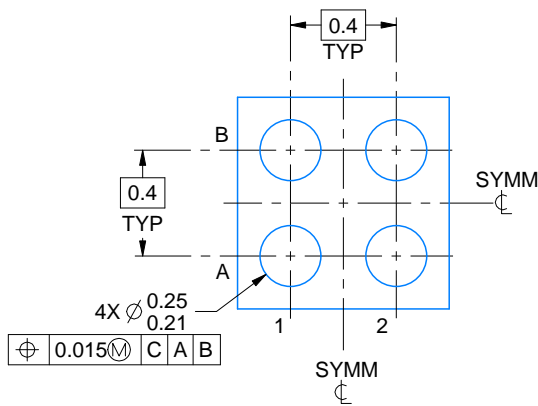
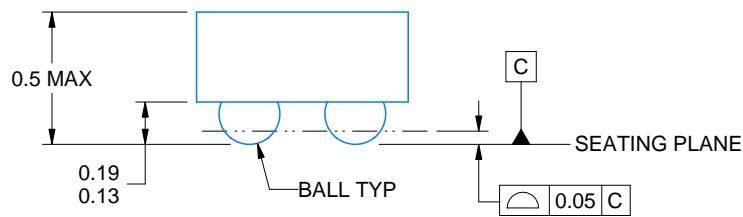
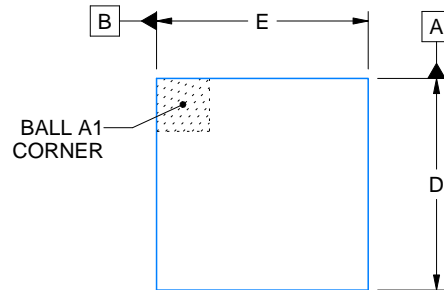

D: Max = 0.79 mm, Min = 0.73 mm
 E: Max = 0.79 mm, Min = 0.73 mm

4223507/A 01/2017

NOTES:

1. All linear dimensions are in millimeters. Any dimensions in parenthesis are for reference only. Dimensioning and tolerancing per ASME Y14.5M.
2. This drawing is subject to change without notice.

EXAMPLE BOARD LAYOUT

YFP0004

DSBGA - 0.5 mm max height

DIE SIZE BALL GRID ARRAY

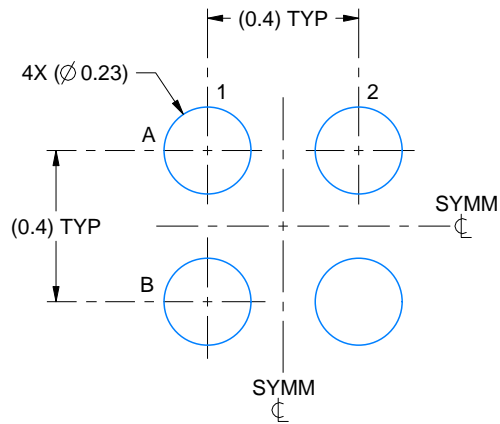

LAND PATTERN EXAMPLE
EXPOSED METAL SHOWN
SCALE:50X

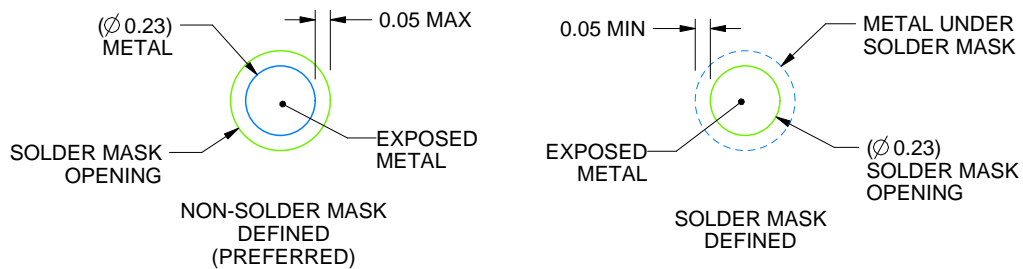

SOLDER MASK DETAILS
NOT TO SCALE

4223507/A 01/2017

NOTES: (continued)

- Final dimensions may vary due to manufacturing tolerance considerations and also routing constraints. For more information, see Texas Instruments literature number SNVA009 (www.ti.com/lit/snva009).

EXAMPLE STENCIL DESIGN

YFP0004

DSBGA - 0.5 mm max height

DIE SIZE BALL GRID ARRAY

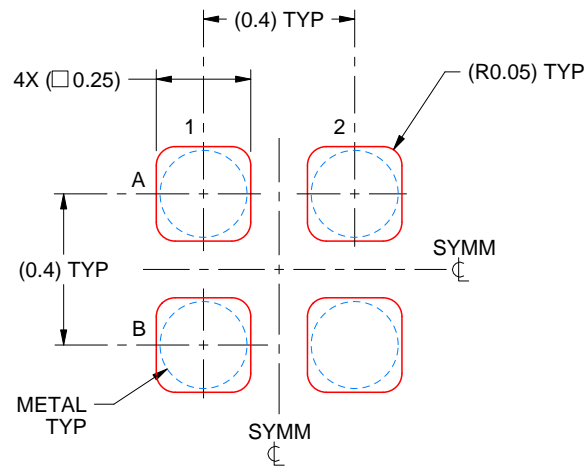

SOLDER PASTE EXAMPLE
BASED ON 0.1 mm THICK STENCIL
SCALE:50X

4223507/A 01/2017

NOTES: (continued)

4. Laser cutting apertures with trapezoidal walls and rounded corners may offer better paste release.

IMPORTANT NOTICE AND DISCLAIMER

TI PROVIDES TECHNICAL AND RELIABILITY DATA (INCLUDING DATASHEETS), DESIGN RESOURCES (INCLUDING REFERENCE DESIGNS), APPLICATION OR OTHER DESIGN ADVICE, WEB TOOLS, SAFETY INFORMATION, AND OTHER RESOURCES "AS IS" AND WITH ALL FAULTS, AND DISCLAIMS ALL WARRANTIES, EXPRESS AND IMPLIED, INCLUDING WITHOUT LIMITATION ANY IMPLIED WARRANTIES OF MERCHANTABILITY, FITNESS FOR A PARTICULAR PURPOSE OR NON-INFRINGEMENT OF THIRD PARTY INTELLECTUAL PROPERTY RIGHTS.

These resources are intended for skilled developers designing with TI products. You are solely responsible for (1) selecting the appropriate TI products for your application, (2) designing, validating and testing your application, and (3) ensuring your application meets applicable standards, and any other safety, security, or other requirements. These resources are subject to change without notice. TI grants you permission to use these resources only for development of an application that uses the TI products described in the resource. Other reproduction and display of these resources is prohibited. No license is granted to any other TI intellectual property right or to any third party intellectual property right. TI disclaims responsibility for, and you will fully indemnify TI and its representatives against, any claims, damages, costs, losses, and liabilities arising out of your use of these resources.

TI's products are provided subject to TI's Terms of Sale (www.ti.com/legal/termsofsale.html) or other applicable terms available either on ti.com or provided in conjunction with such TI products. TI's provision of these resources does not expand or otherwise alter TI's applicable warranties or warranty disclaimers for TI products.

Mailing Address: Texas Instruments, Post Office Box 655303, Dallas, Texas 75265
Copyright © 2019, Texas Instruments Incorporated