

TPS22907 3.6-V, 1-A, 44-mΩ ON-Resistance Load Switch With Controlled Turnon

1 Features

- Integrated P-Channel Load Switch
- Low Input Voltage: 1.1 V to 3.6 V
- ON-Resistance (Typical Values):
 - $R_{ON} = 44 \text{ m}\Omega$ at $V_{IN} = 3.6 \text{ V}$
 - $R_{ON} = 50 \text{ m}\Omega$ at $V_{IN} = 2.5 \text{ V}$
 - $R_{ON} = 58 \text{ m}\Omega$ at $V_{IN} = 1.8 \text{ V}$
 - $R_{ON} = 83 \text{ m}\Omega$ at $V_{IN} = 1.2 \text{ V}$
- 1-A Maximum Continuous Switch Current
- Maximum Quiescent Current (I_Q) < 1 μA
- Maximum Shutdown Current (I_{SD}) < 1 μA
- Low Control Input Thresholds Enable Use of 1.2-V, 1.8-V, 2.5-V, and 3.3-V Logic
- Controlled Slew-Rate to Avoid Inrush Currents
 - $t_R = 25 \text{ }\mu\text{s}$ at $V_{IN} = 3.6 \text{ V}$
 - $t_R = 36 \text{ }\mu\text{s}$ at $V_{IN} = 1.8 \text{ V}$
- ESD Performance Tested Per JESD 22
 - 3000-V Human Body Model (A114-B, Class II)
 - 1000-V Charged-Device Model (C101)
- Ultra-Small 4-Terminal Wafer-Chip-Scale Package (WCSP)
 - Nominal Dimensions Shown – See Addendum for Details
 - 0.9 mm x 0.9 mm, 0.5-mm Pitch, 0.5-mm Height (YZT)

2 Applications

- Battery-Powered Equipment
- Portable Industrial Equipment
- Portable Medical Equipment
- Portable Media Players
- Point-of-Sale Terminal
- GPS Devices
- Digital Cameras
- Portable Instrumentation
- Smart Phones and Tablets

3 Description

The TPS22907 is a small, low R_{ON} load switch with controlled turnon. The device contains a P-channel MOSFET that operates over an input voltage range of 1.1 V to 3.6 V. The switch is controlled by an on and off input (ON), which can interface directly with low-voltage control signals.

The TPS22907 is available in a space-saving 4-terminal WCSP with 0.5-mm pitch (YZT). The device is characterized for operation over the free-air temperature range of -40°C to 85°C .

Device Information⁽¹⁾

PART NUMBER	PACKAGE	BODY SIZE (NOM)
TPS22907	DSBGA (4)	0.90 mm x 0.90 mm

(1) For all available packages, see the orderable addendum at the end of the data sheet.

Typical Application

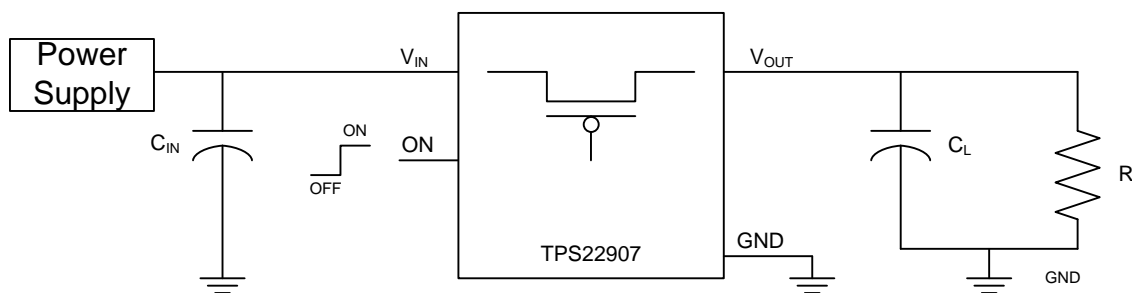

Table of Contents

1 Features	1	8 Detailed Description	11
2 Applications	1	8.1 Overview	11
3 Description	1	8.2 Functional Block Diagram	11
4 Revision History	2	8.3 Feature Description	11
5 Pin Configuration and Functions	3	8.4 Device Functional Modes	11
6 Specifications	3	9 Application and Implementation	12
6.1 Absolute Maximum Ratings	3	9.1 Application Information	12
6.2 ESD Ratings	3	9.2 Typical Application	12
6.3 Recommended Operating Conditions	4	10 Power Supply Recommendations	14
6.4 Thermal Information	4	11 Layout	14
6.5 Electrical Characteristics	4	11.1 Layout Guidelines	14
6.6 Switching Characteristics: $V_{IN} = 3.6\text{ V}$	5	11.2 Layout Example	14
6.7 Switching Characteristics: $V_{IN} = 1.8\text{ V}$	5	12 Device and Documentation Support	15
6.8 Switching Characteristics: $V_{IN} = 1.1\text{ V}$	5	12.1 Trademarks	15
6.9 Typical DC Characteristics	6	12.2 Electrostatic Discharge Caution	15
6.10 Typical AC Characteristics	8	12.3 Glossary	15
7 Parameter Measurement Information	10	13 Mechanical, Packaging, and Orderable Information	15

4 Revision History

NOTE: Page numbers for previous revisions may differ from page numbers in the current version.

Changes from Revision A (September 2013) to Revision B	Page
<ul style="list-style-type: none"> Added <i>ESD Ratings</i> table, <i>Feature Description</i> section, <i>Device Functional Modes</i>, <i>Application and Implementation</i> section, <i>Power Supply Recommendations</i> section, <i>Layout</i> section, <i>Device and Documentation Support</i> section, and <i>Mechanical, Packaging, and Orderable Information</i> section 	3

Changes from Original (November 2009) to Revision A	Page
<ul style="list-style-type: none"> Changed Feature from: Ultra-Low ON-State Resistance to: Ultra-Low ON-State Resistance (R_{ON}) Changed the Feature for the Wafer-Chip-Scale Package Changed Application from: Point Of Sales Terminal to: Point of Sale Terminal Changed Application from: Smartphones to: Smartphones / Tablets Deleted the <i>Ordering Information</i> table Changed the I_{IN} Test Condition from: $I_{OUT} = 0$ to $I_{OUT} = 0\text{ mA}$ Changed the $I_{IN(OFF)}$ Test Condition from: $V_{ON} = \text{GND}$ to $V_{ON} = 0\text{ V}$ Changed the $I_{IN(LEAKAGE)}$ Test Condition from: $V_{ON} = \text{GND}$, $V_{OUT} = 0$ to $V_{ON} = 0\text{ V}$, $V_{OUT} = 0\text{ V}$ Changed Table 1, Device Feature List 	11

5 Pin Configuration and Functions

**YZT Package
4-Pin DSBGA
(Laser Marking View)**

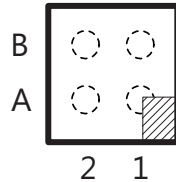

**YZT Package
4-Pin DSBGA
(Bump View)**

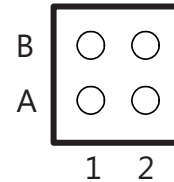

Pin Functions

PIN		I/O	DESCRIPTION
NO.	NAME		
A1	V _{OUT}	O	Switch output
A2	V _{IN}	I	Switch input, bypass capacitor recommended for minimizing V _{IN} dip. See Feature Description .
B1	GND	—	Ground
B2	ON	I	Switch control input, active high. Do not leave floating.

6 Specifications

6.1 Absolute Maximum Ratings

over operating free-air temperature range (unless otherwise noted)⁽¹⁾

		MIN	MAX	UNIT
V _{IN}	Input voltage	-0.3	4	V
V _{OUT}	Output voltage	-0.3	(V _{IN} + 0.3)	V
V _{ON}	Input voltage	-0.3	4	V
I _{MAX}	Maximum continuous switch current		1	A
I _{PLS}	Maximum pulsed current (100-μs pulse, 2% duty cycle), T _A = -40°C to +85°C		2.7	A
T _J	Maximum junction temperature		125	°C
T _{LEAD}	Maximum lead temperature (10-s soldering time)		300	°C
T _{stg}	Storage temperature	-65	150	°C

- (1) Stresses beyond those listed under *Absolute Maximum Ratings* may cause permanent damage to the device. These are stress ratings only, which do not imply functional operation of the device at these or any other conditions beyond those indicated under *Recommended Operating Conditions*. Exposure to absolute-maximum-rated conditions for extended periods may affect device reliability.

6.2 ESD Ratings

		VALUE	UNIT
V _(ESD)	Electrostatic discharge	Human body model (HBM), per ANSI/ESDA/JEDEC JS-001, all pins ⁽¹⁾	±3000
		Charged-device model (CDM), per JEDEC specification JESD22-C101, all pins ⁽²⁾	±1000

- (1) JEDEC document JEP155 states that 500-V HBM allows safe manufacturing with a standard ESD control process.

- (2) JEDEC document JEP157 states that 250-V CDM allows safe manufacturing with a standard ESD control process.

6.3 Recommended Operating Conditions

		MIN	MAX	UNIT
V_{IN}	Input voltage range	1.1	3.6	V
V_{OUT}	Output voltage range		V_{IN}	V
V_{IH}	High-level input voltage, ON	0.85	3.6	V
V_{IL}	Low-level input voltage, ON		0.4	V
C_{IN}	Input capacitor	1 ⁽¹⁾		μF
T_A	Operating free-air temperature	-40	85	°C

(1) See [Application Information](#).

6.4 Thermal Information

	THERMAL METRIC ⁽¹⁾⁽²⁾	TPS22907		UNIT
		YZT (DSBGA)		
		4 PINS		
$R_{\theta JA}$	Junction-to-ambient thermal resistance	189.4		°C/W
$R_{\theta JC(top)}$	Junction-to-case(top) thermal resistance	1.9		
$R_{\theta JB}$	Junction-to-board thermal resistance	37.2		
Ψ_{JT}	Junction-to-top characterization parameter	10.2		
Ψ_{JB}	Junction-to-board characterization parameter	37		
$R_{\theta JC(bot)}$	Junction-to-case(bottom) thermal resistance	—		

(1) For more information about traditional and new thermal metrics, see the IC Package Thermal Metrics application report, [SPRA953](#)

(2) For thermal estimates of this device based on PCB copper area, see the TI PCB Thermal Calculator.

6.5 Electrical Characteristics

Unless otherwise noted, the specification applies over the operating ambient temperature $-40^{\circ}\text{C} \leq T_A \leq 85^{\circ}\text{C}$ and $V_{IN} = 1.1\text{ V}$ to 3.6 V. Typical values are for $V_{IN} = 3.6\text{ V}$ and $T_A = 25^{\circ}\text{C}$.

PARAMETER	TEST CONDITIONS	T_A	MIN	TYP	MAX	UNIT			
I_Q	Quiescent current	$I_{OUT} = 0\text{ mA}$, $V_{IN} = V_{ON}$	Full	0.07	1	μA			
I_{SD}	Off supply current	$V_{ON} = 0\text{ V}$, $OUT = \text{Open}$	Full	0.05	1	μA			
$I_{IN(LEAKAGE)}$	Leakage current	$V_{ON} = 0\text{ V}$, $V_{OUT} = 0\text{ V}$	Full	0.05	1	μA			
R_{ON}	ON-state resistance	$V_{IN} = 3.6\text{ V}$, $I_{OUT} = -200\text{ mA}$	25°C	44	60	mΩ			
			Full		67				
		$V_{IN} = 2.5\text{ V}$, $I_{OUT} = -200\text{ mA}$	25°C	50	63				
			Full		70				
		$V_{IN} = 1.8\text{ V}$, $I_{OUT} = -200\text{ mA}$	25°C	58	72				
			Full		80				
		$V_{IN} = 1.2\text{ V}$, $I_{OUT} = -200\text{ mA}$	25°C	83	106				
			Full		117				
		$V_{IN} = 1.1\text{ V}$, $I_{OUT} = -200\text{ mA}$	25°C	97	125				
			Full		140				
		I_{ON}	ON input leakage current	$V_{ON} = 0\text{ V}$ to 3.6 V	Full		0.005	1	μA

6.6 Switching Characteristics: $V_{IN} = 3.6\text{ V}$

 $T_A = 25^\circ\text{C}$ (unless otherwise noted)

PARAMETER		TEST CONDITIONS	MIN	TYP	MAX	UNIT
t_{ON}	Turn-ON time	$R_L = 500\ \Omega, C_L = 0.1\ \mu\text{F}$		28		μs
t_{OFF}	Turn-OFF time	$R_L = 500\ \Omega, C_L = 0.1\ \mu\text{F}$		40		μs
t_r	V_{OUT} rise time	$R_L = 500\ \Omega, C_L = 0.1\ \mu\text{F}$		25		μs
t_f	V_{OUT} fall time	$R_L = 500\ \Omega, C_L = 0.1\ \mu\text{F}$		116		μs

6.7 Switching Characteristics: $V_{IN} = 1.8\text{ V}$

 $T_A = 25^\circ\text{C}$ (unless otherwise noted)

PARAMETER		TEST CONDITIONS	MIN	TYP	MAX	UNIT
t_{ON}	Turn-ON time	$R_L = 500\ \Omega, C_L = 0.1\ \mu\text{F}$		48		μs
t_{OFF}	Turn-OFF time	$R_L = 500\ \Omega, C_L = 0.1\ \mu\text{F}$		40		μs
t_r	V_{OUT} rise time	$R_L = 500\ \Omega, C_L = 0.1\ \mu\text{F}$		36		μs
t_f	V_{OUT} fall time	$R_L = 500\ \Omega, C_L = 0.1\ \mu\text{F}$		113		μs

6.8 Switching Characteristics: $V_{IN} = 1.1\text{ V}$

 $T_A = 25^\circ\text{C}$ (unless otherwise noted)

PARAMETER		TEST CONDITIONS	MIN	TYP	MAX	UNIT
t_{ON}	Turn-ON time	$R_L = 500\ \Omega, C_L = 0.1\ \mu\text{F}$		81		μs
t_{OFF}	Turn-OFF time	$R_L = 500\ \Omega, C_L = 0.1\ \mu\text{F}$		42		μs
t_r	V_{OUT} rise time	$R_L = 500\ \Omega, C_L = 0.1\ \mu\text{F}$		57		μs
t_f	V_{OUT} fall time	$R_L = 500\ \Omega, C_L = 0.1\ \mu\text{F}$		113		μs

6.9 Typical DC Characteristics

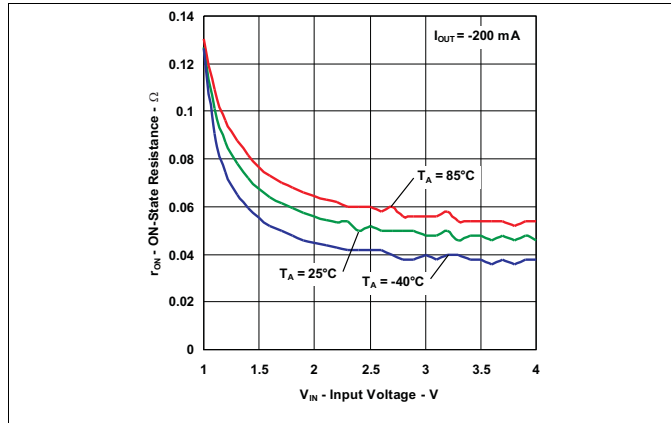

Figure 1. ON-State Resistance vs. Input Voltage

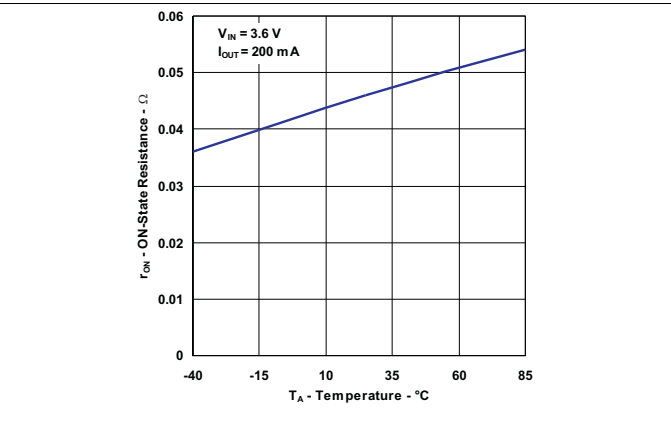

Figure 2. ON-State Resistance vs. Temperature

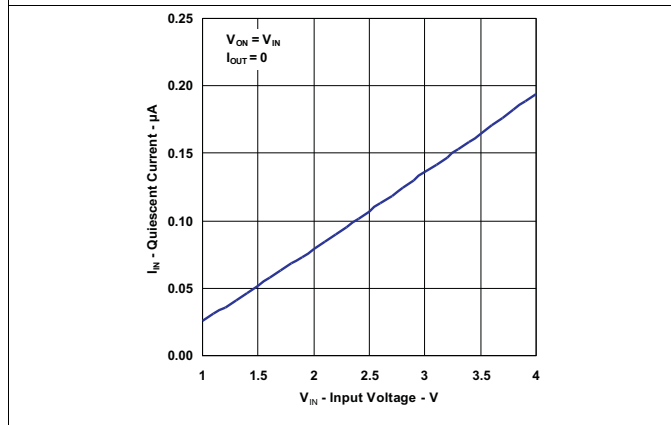

Figure 3. V_{IN} Quiescent Current vs. Input Voltage

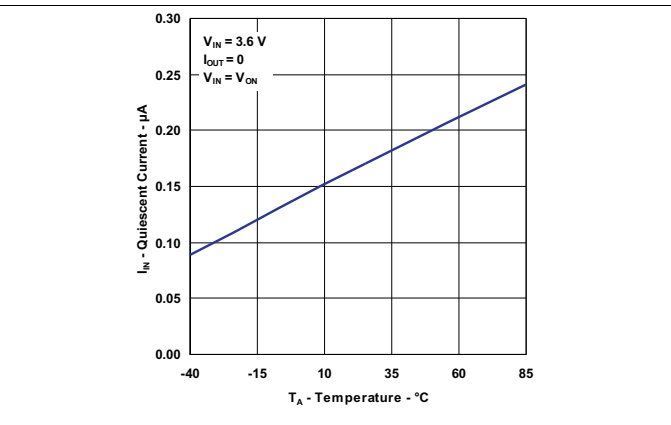

Figure 4. V_{IN} Quiescent Current vs. Temperature

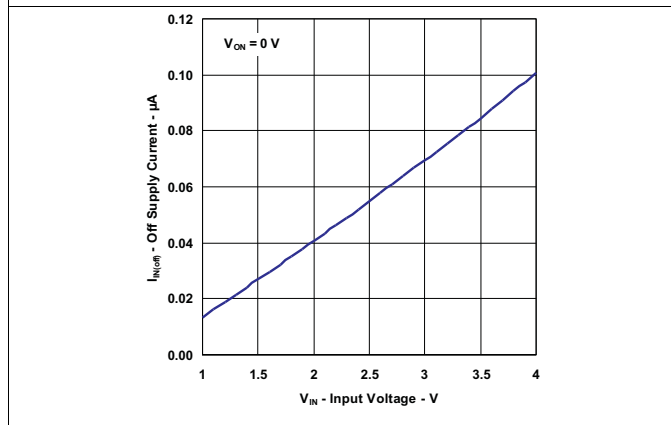

Figure 5. V_{IN} Off Supply Current vs. Input Voltage

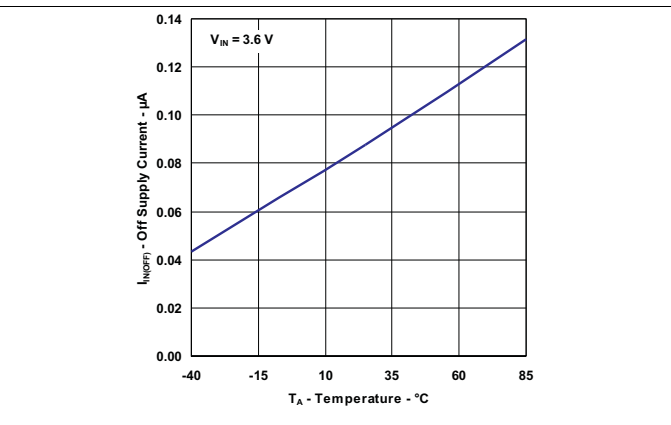

Figure 6. V_{IN} OFF Supply Current vs. Temperature

Typical DC Characteristics (continued)

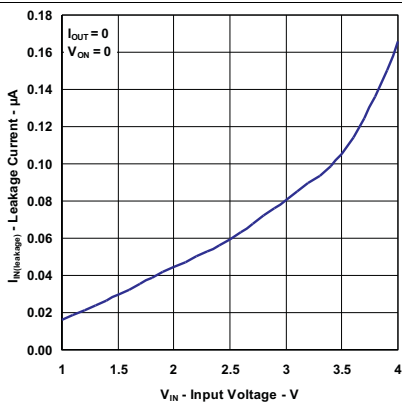

Figure 7. V_{IN} Leakage Current vs. Input Voltage

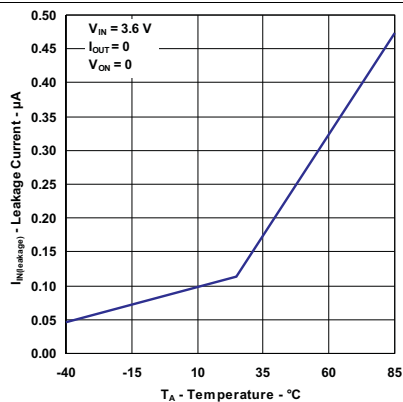

Figure 8. V_{IN} Leakage Current vs. Temperature

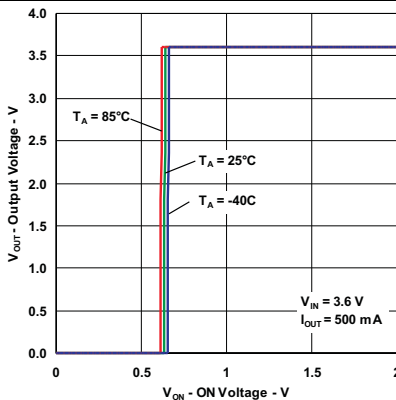

Figure 9. ON Input Threshold

6.10 Typical AC Characteristics

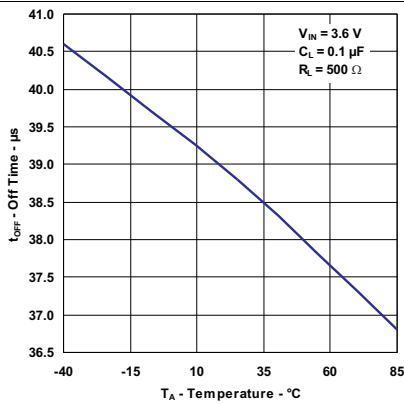

Figure 10. OFF Time vs. Temperature

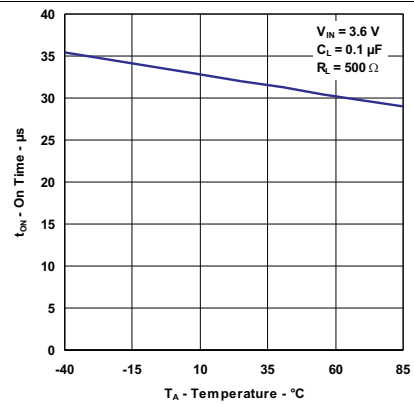

Figure 11. ON Time vs. Temperature

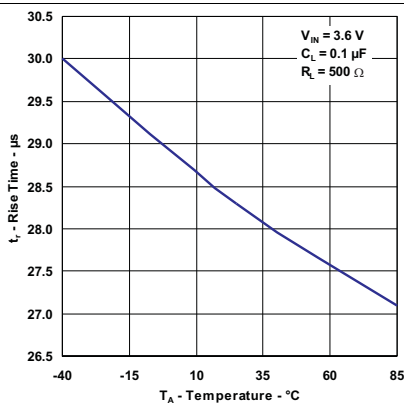

Figure 12. Rise Time vs. Temperature

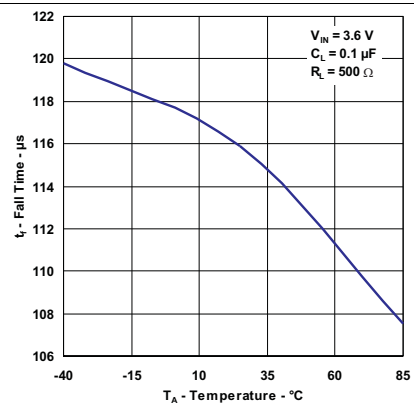

Figure 13. Fall Time vs. Temperature

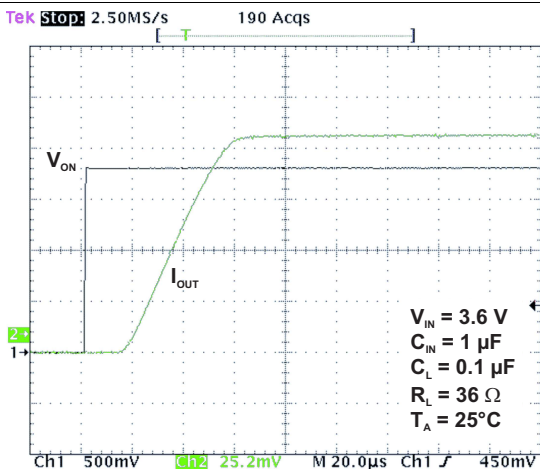

Figure 14. t_{ON} Response

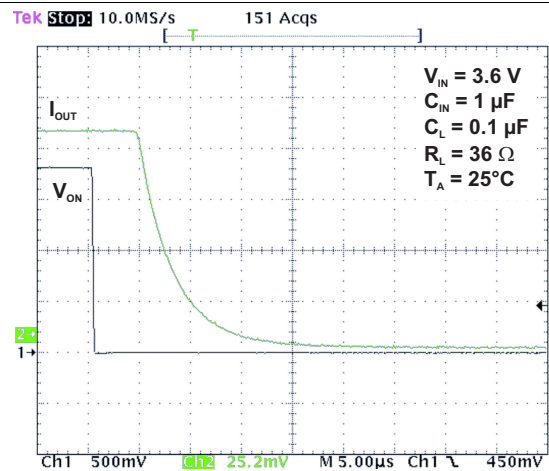
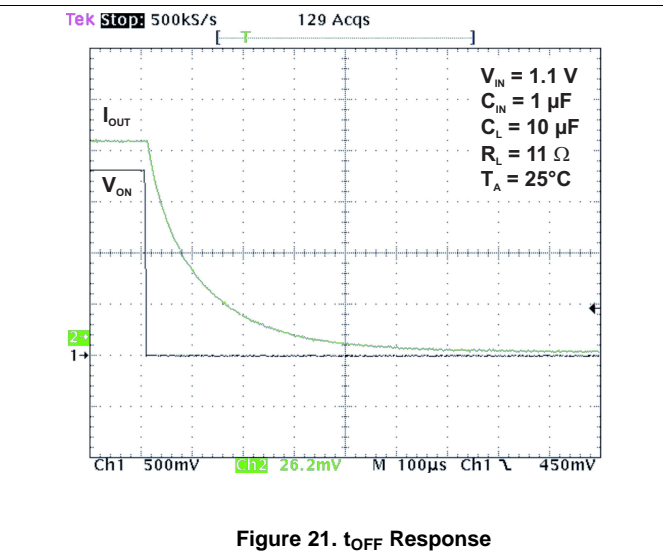
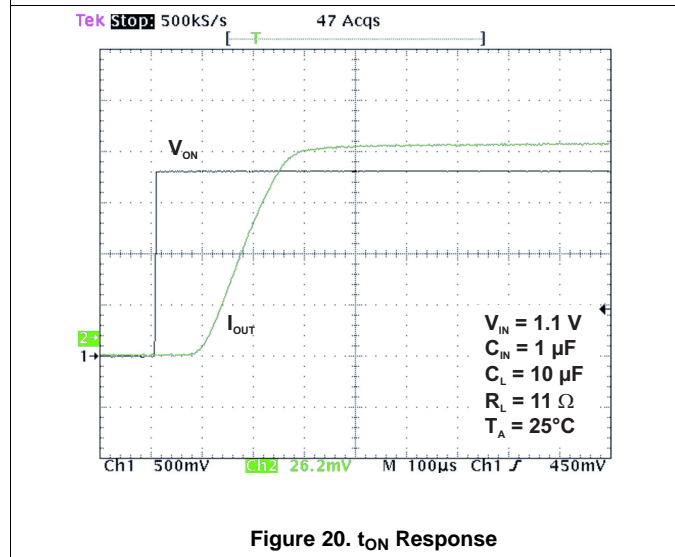
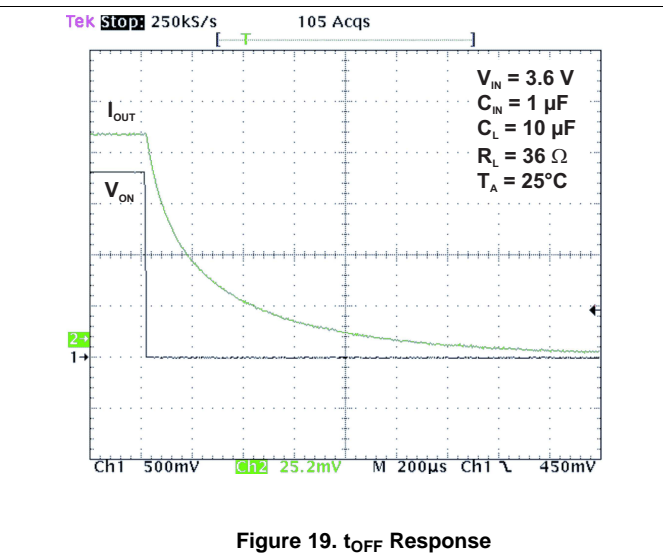
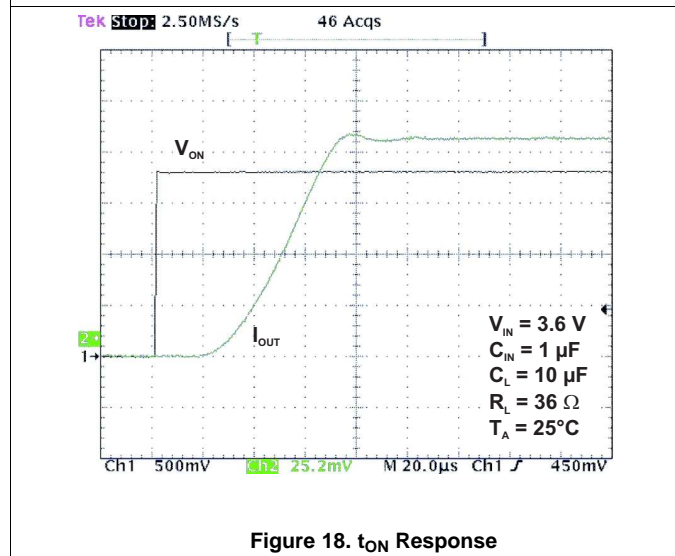
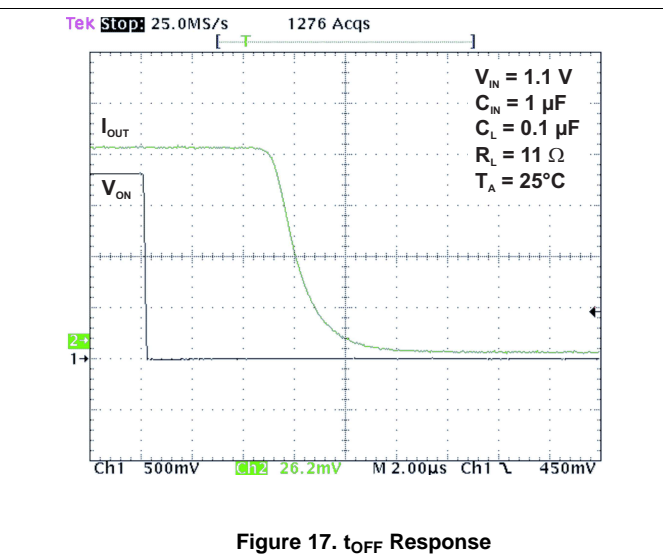
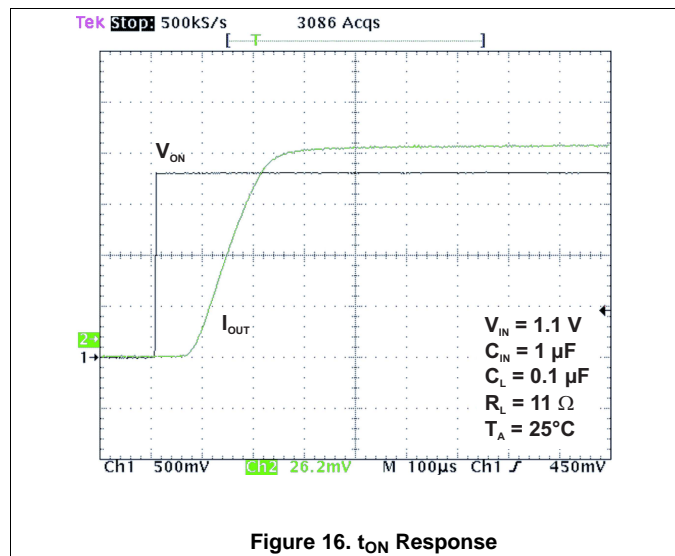
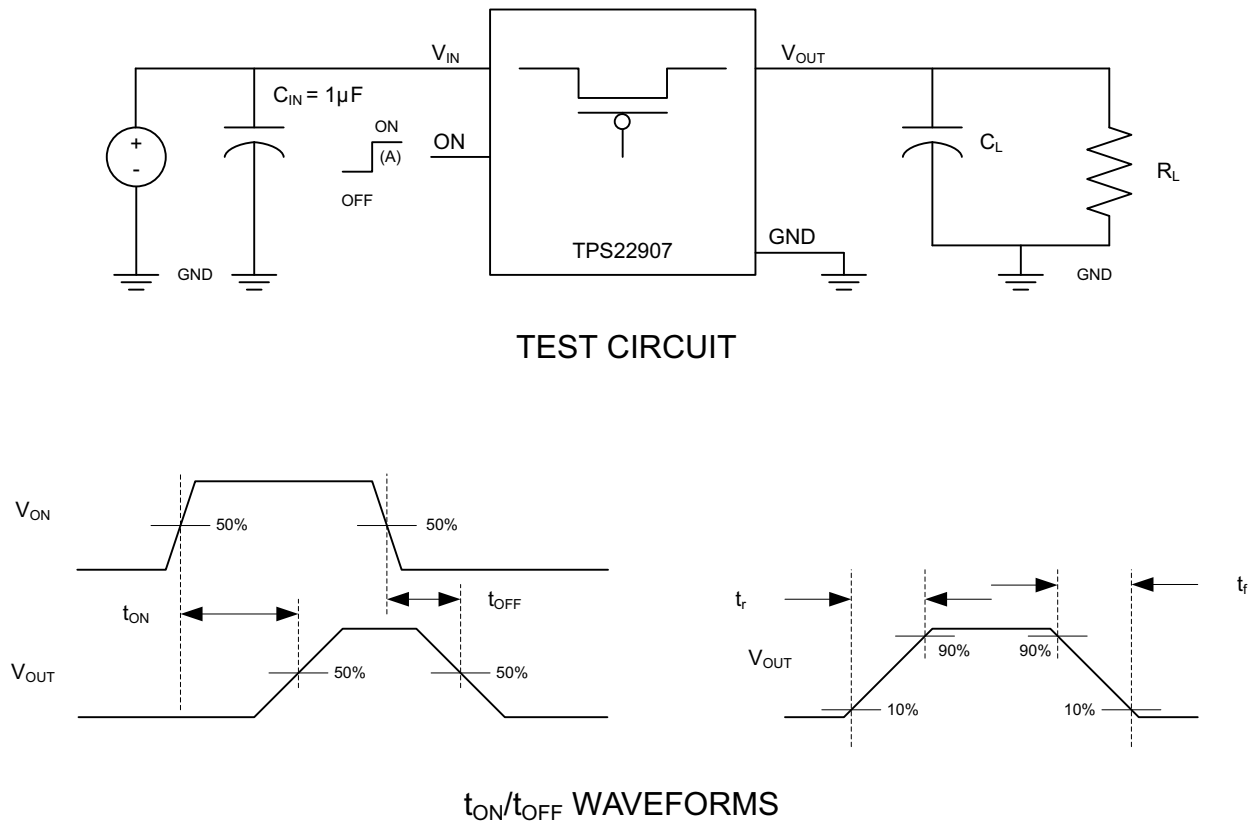

Figure 15. t_{OFF} Response

Typical AC Characteristics (continued)



7 Parameter Measurement Information



(A) Control signal rise and fall times are 100 ns.

Figure 22. Test Circuit and t_{ON}/t_{OFF} Waveforms

8 Detailed Description

8.1 Overview

The TPS22907 is a single-channel, 1-A load switch in a small, space-saving DSBGA-4 package. This device implements a P-channel MOSFET to provide a low ON-resistance for a low-voltage drop across the device. A controlled rise time is used in applications to limit the inrush current.

8.2 Functional Block Diagram

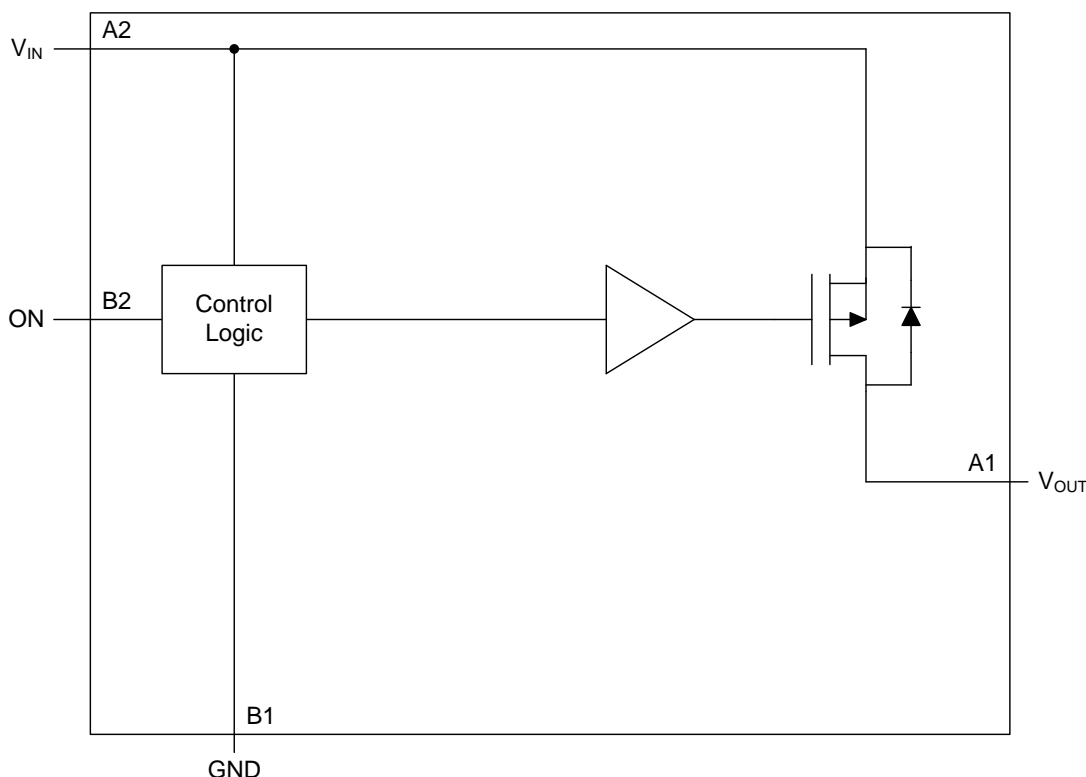

8.3 Feature Description

Table 1. Device Feature List

DEVICE	R_{ON} (Typical) $V_{IN} = 1.8\text{ V}$	SLEW RATE (Typical) $V_{IN} = 1.8\text{ V}$	MAXIMUM OUTPUT CURRENT	ENABLE
TPS22907	58 m Ω	36 μs	1 A	Active high

8.3.1 On and Off Control

The ON pin controls the state of the switch. Asserting ON high enables the switch. ON is active high and has a low threshold, making it capable of interfacing with low-voltage signals. The ON pin is compatible with standard GPIO logic threshold. It can be used with any microcontroller with 1.2-V, 1.8-V, 2.5-V, or 3.3-V GPIOs.

8.4 Device Functional Modes

Table 2. Function Table

ON (Control Input)	V_{IN} to V_{OUT}
L	OFF
H	ON

9 Application and Implementation

NOTE

Information in the following applications sections is not part of the TI component specification, and TI does not warrant its accuracy or completeness. TI's customers are responsible for determining suitability of components for their purposes. Customers should validate and test their design implementation to confirm system functionality.

9.1 Application Information

9.1.1 Input Capacitor

To limit the voltage drop on the input supply caused by transient inrush currents when the switch turns on into a discharged load capacitor, a capacitor needs to be placed between V_{IN} and GND. A 1- μF ceramic capacitor, C_{IN} , placed close to the pins is usually sufficient. Higher values of C_{IN} can be used to further reduce the voltage drop during high-current application. When switching heavy loads, TI recommends having an input capacitor approximately ten times higher than the output capacitor to avoid excessive voltage drop.

9.1.2 Output Capacitor

Due to the integrated body diode in the PMOS switch, a C_{IN} greater than C_L is highly recommended. A C_L greater than C_{IN} can cause V_{OUT} to exceed V_{IN} when the system supply is removed. This could result in current flow through the body diode from V_{OUT} to V_{IN} . A C_{IN} to C_L ratio of at least 10 to 1 is recommended for minimizing V_{IN} dip caused by inrush currents during startup; however, a 10 to 1 ratio for capacitance is not required for proper functionality of the device. A ratio smaller than 10 to 1 (such as 1 to 1) could cause slightly more V_{IN} dip at turnon due to inrush currents.

9.2 Typical Application

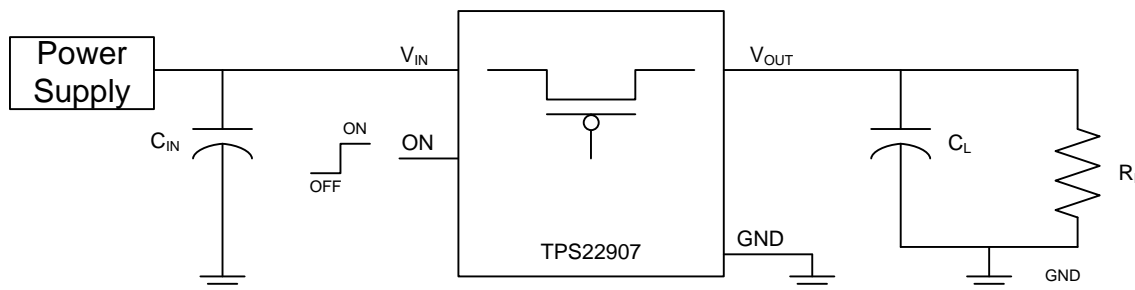

Figure 23. Typical Application Schematic

9.2.1 Design Requirements

Table 3 lists the design requirements for the device.

Table 3. Design Parameters

DESIGN PARAMETER	EXAMPLE VALUE
V_{IN}	3.6 V
C_L	4.7 μF
Load current	1 A
Ambient Temperature	25 $^{\circ}\text{C}$
Maximum inrush current	750 mA

9.2.2 Detailed Design Procedure

9.2.2.1 Managing Inrush Current

When the switch is enabled, the output capacitors must be charged up from 0 V to the set value (3.6 V in this example). This charge arrives in the form of inrush current. Inrush current can be calculated using the following equation:

$$I_{\text{INRUSH}} = C_L \times \frac{dV_{\text{OUT}}}{dt}$$

where:

- C_L = Output capacitance
- dV_{OUT} = Output voltage
- dt = Rise time

(1)

The TPS22907 offers a controlled rise time for minimizing inrush current. This device can be selected based upon the minimum acceptable rise time which can be calculated using the design requirements and the inrush current equation. An output capacitance of 4.7 μF will be used because the amount of inrush current increases with output capacitance:

$$750 \text{ mA} = 4.7 \mu\text{F} \times 3.6 \text{ V} / dt$$

where

- $dt = 22.56 \mu\text{s}$

(2)

To ensure an inrush current of less than 750 mA, a device with a rise time greater than 22.56 μs must be used. The TPS22907 has a typical rise time of 25 μs at 3.6 V which meets the above design requirements.

9.2.2.2 Voltage Drop from V_{IN} to V_{OUT}

The voltage drop from V_{IN} to V_{OUT} is determined by the ON-resistance of the device and the load current. R_{ON} can be found in [Electrical Characteristics](#) and is dependent on temperature. When the value of R_{ON} is found, the following equation can be used to calculate the voltage drop across the device:

$$\Delta V = I_{\text{LOAD}} \times R_{\text{ON}}$$

where:

- ΔV = Voltage drop across the device
- I_{LOAD} = Load current
- R_{ON} = ON-resistance of the device

(3)

At $V_{\text{IN}} = 3.6 \text{ V}$, the TPS22907 has an R_{ON} value of 44 m Ω . Using this value and the defined load current, the above equation can be evaluated:

$$\Delta V = 1 \text{ A} \times 44 \text{ m}\Omega$$

$$\Delta V = 44 \text{ mV}$$

(4)

Therefore, the voltage drop across the device will be 44 mV.

9.2.3 Application Curve

Figure 24 shows the inrush current expected for different load capacitances at varying V_{IN} voltages.

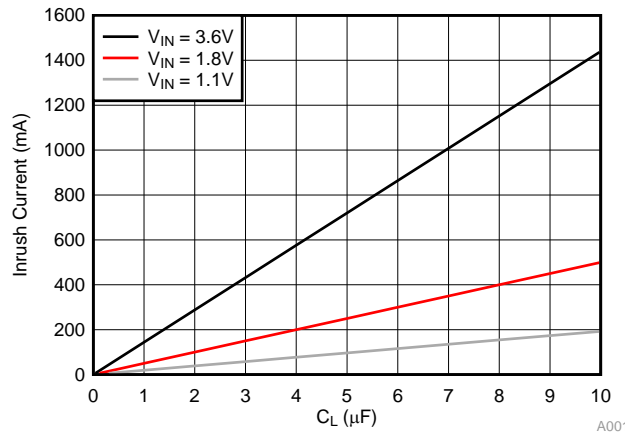

Figure 24. Expected Inrush Current vs Load Capacitance

10 Power Supply Recommendations

The device is designed to operate with a V_{IN} voltage range of 1.1 V to 3.6 V. The power supply should be well regulated and placed as close to the device terminals as possible. It must be able to withstand all transient and load current steps. In most situations, using the minimum recommended input capacitance of 1 μF is sufficient to prevent the supply voltage from dipping when the switch is turned on. In cases where the power supply is slow to respond to a large transient current or large load current step, additional bulk capacitance may be required on the input.

11 Layout

11.1 Layout Guidelines

For best performance, V_{IN} and V_{OUT} traces should be as short and wide as possible to help minimize the parasitic electrical effects. To be most effective, the input and output capacitors should be placed close to the device to minimize the effects that parasitic trace inductances may have on normal operation.

11.2 Layout Example

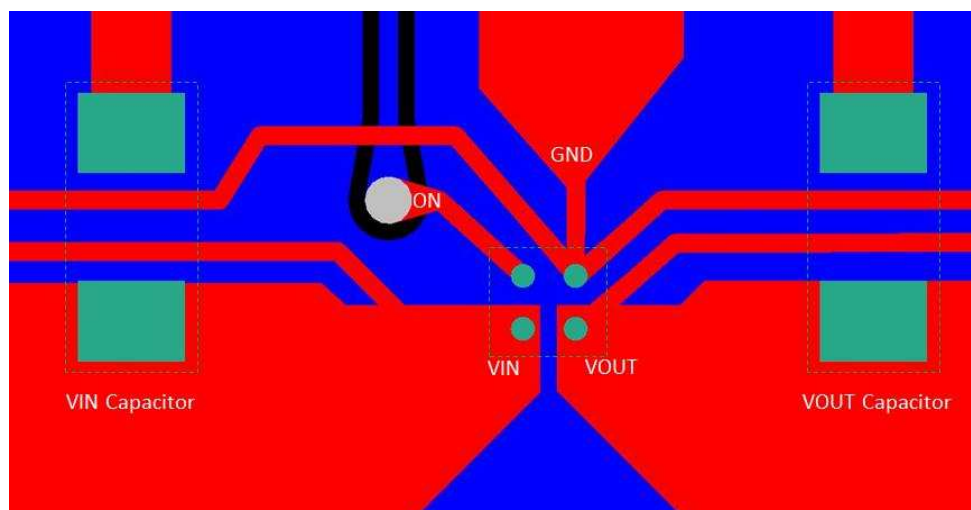

Figure 25. Example Layout for the TPS22907

12 Device and Documentation Support

12.1 Trademarks

All trademarks are the property of their respective owners.

12.2 Electrostatic Discharge Caution



These devices have limited built-in ESD protection. The leads should be shorted together or the device placed in conductive foam during storage or handling to prevent electrostatic damage to the MOS gates.

12.3 Glossary

[SLYZ022](#) — *TI Glossary*.

This glossary lists and explains terms, acronyms, and definitions.

13 Mechanical, Packaging, and Orderable Information

The following pages include mechanical, packaging, and orderable information. This information is the most current data available for the designated devices. This data is subject to change without notice and revision of this document. For browser-based versions of this data sheet, refer to the left-hand navigation.

PACKAGING INFORMATION

Orderable Device	Status (1)	Package Type	Package Drawing	Pins	Package Qty	Eco Plan (2)	Lead/Ball Finish (6)	MSL Peak Temp (3)	Op Temp (°C)	Device Marking (4/5)	Samples
TPS22907YZTR	NRND	DSBGA	YZT	4	3000	Green (RoHS & no Sb/Br)	SNAGCU	Level-1-260C-UNLIM	-40 to 85	5K (F ~ G)	
TPS22907YZTT	NRND	DSBGA	YZT	4	250	Green (RoHS & no Sb/Br)	SNAGCU	Level-1-260C-UNLIM	-40 to 85	5K (F ~ G)	

(1) The marketing status values are defined as follows:

ACTIVE: Product device recommended for new designs.

LIFEBUY: TI has announced that the device will be discontinued, and a lifetime-buy period is in effect.

NRND: Not recommended for new designs. Device is in production to support existing customers, but TI does not recommend using this part in a new design.

PREVIEW: Device has been announced but is not in production. Samples may or may not be available.

OBSOLETE: TI has discontinued the production of the device.

(2) **RoHS:** TI defines "RoHS" to mean semiconductor products that are compliant with the current EU RoHS requirements for all 10 RoHS substances, including the requirement that RoHS substance do not exceed 0.1% by weight in homogeneous materials. Where designed to be soldered at high temperatures, "RoHS" products are suitable for use in specified lead-free processes. TI may reference these types of products as "Pb-Free".

RoHS Exempt: TI defines "RoHS Exempt" to mean products that contain lead but are compliant with EU RoHS pursuant to a specific EU RoHS exemption.

Green: TI defines "Green" to mean the content of Chlorine (Cl) and Bromine (Br) based flame retardants meet JS709B low halogen requirements of <=1000ppm threshold. Antimony trioxide based flame retardants must also meet the <=1000ppm threshold requirement.

(3) MSL, Peak Temp. - The Moisture Sensitivity Level rating according to the JEDEC industry standard classifications, and peak solder temperature.

(4) There may be additional marking, which relates to the logo, the lot trace code information, or the environmental category on the device.

(5) Multiple Device Markings will be inside parentheses. Only one Device Marking contained in parentheses and separated by a "~" will appear on a device. If a line is indented then it is a continuation of the previous line and the two combined represent the entire Device Marking for that device.

(6) Lead/Ball Finish - Orderable Devices may have multiple material finish options. Finish options are separated by a vertical ruled line. Lead/Ball Finish values may wrap to two lines if the finish value exceeds the maximum column width.

Important Information and Disclaimer:The information provided on this page represents TI's knowledge and belief as of the date that it is provided. TI bases its knowledge and belief on information provided by third parties, and makes no representation or warranty as to the accuracy of such information. Efforts are underway to better integrate information from third parties. TI has taken and continues to take reasonable steps to provide representative and accurate information but may not have conducted destructive testing or chemical analysis on incoming materials and chemicals. TI and TI suppliers consider certain information to be proprietary, and thus CAS numbers and other limited information may not be available for release.

In no event shall TI's liability arising out of such information exceed the total purchase price of the TI part(s) at issue in this document sold by TI to Customer on an annual basis.

TAPE AND REEL INFORMATION

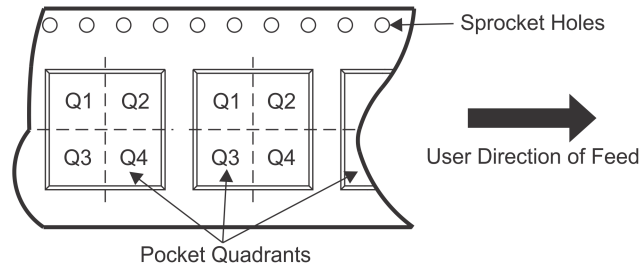
QUADRANT ASSIGNMENTS FOR PIN 1 ORIENTATION IN TAPE

*All dimensions are nominal

Device	Package Type	Package Drawing	Pins	SPQ	Reel Diameter (mm)	Reel Width W1 (mm)	A0 (mm)	B0 (mm)	K0 (mm)	P1 (mm)	W (mm)	Pin1 Quadrant
TPS22907YZTR	DSBGA	YZT	4	3000	178.0	9.2	1.0	1.0	0.73	4.0	8.0	Q1
TPS22907YZTT	DSBGA	YZT	4	250	178.0	9.2	1.0	1.0	0.73	4.0	8.0	Q1

TAPE AND REEL BOX DIMENSIONS

*All dimensions are nominal

Device	Package Type	Package Drawing	Pins	SPQ	Length (mm)	Width (mm)	Height (mm)
TPS22907YZTR	DSBGA	YZT	4	3000	220.0	220.0	35.0
TPS22907YZTT	DSBGA	YZT	4	250	220.0	220.0	35.0



PACKAGE OUTLINE

YZT0004

DSBGA - 0.625 mm max height

DIE SIZE BALL GRID ARRAY

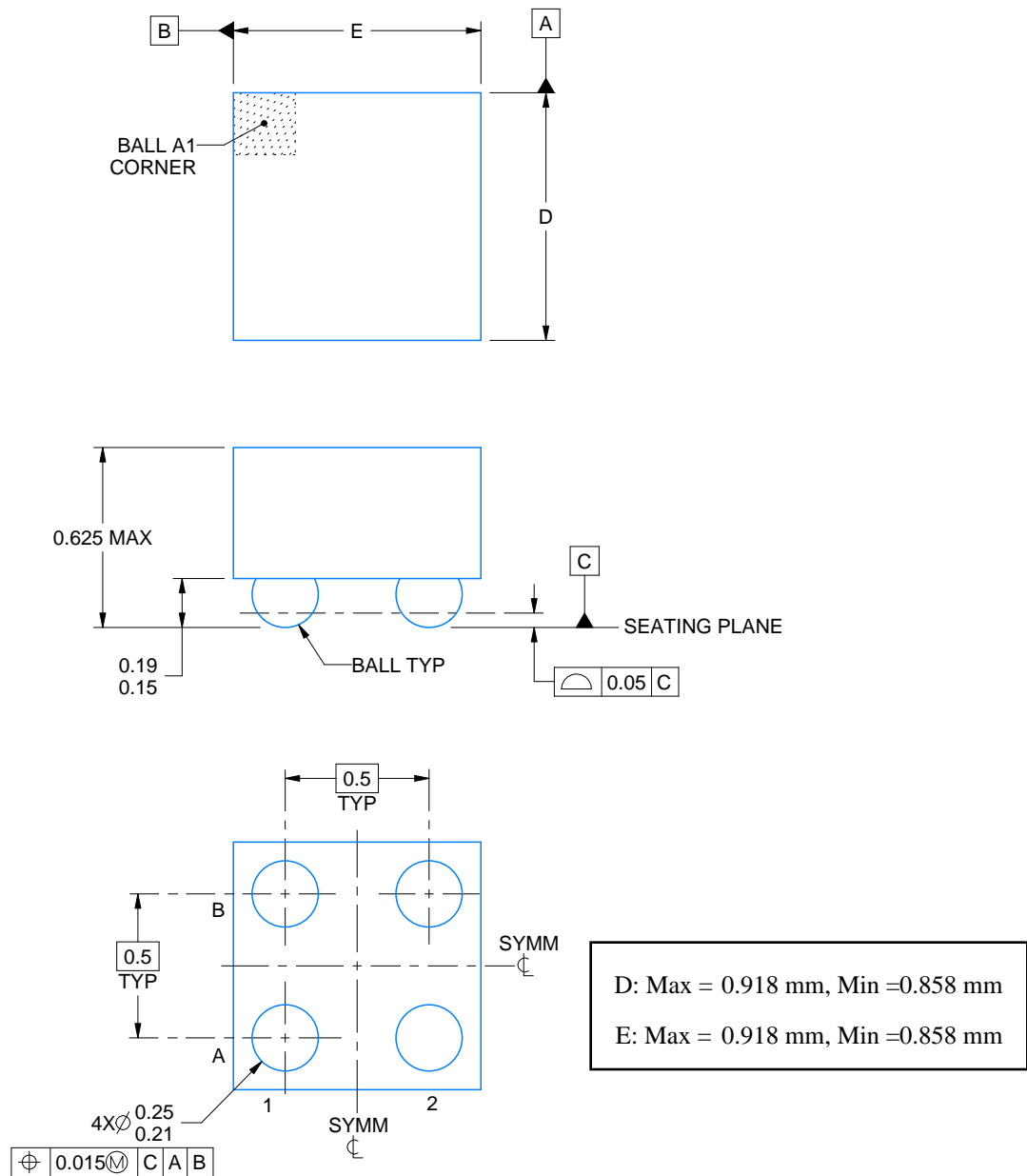

4219477/A 05/2017

NOTES:

1. All linear dimensions are in millimeters. Any dimensions in parenthesis are for reference only. Dimensioning and tolerancing per ASME Y14.5M.
2. This drawing is subject to change without notice.

EXAMPLE BOARD LAYOUT

YZT0004

DSBGA - 0.625 mm max height

DIE SIZE BALL GRID ARRAY

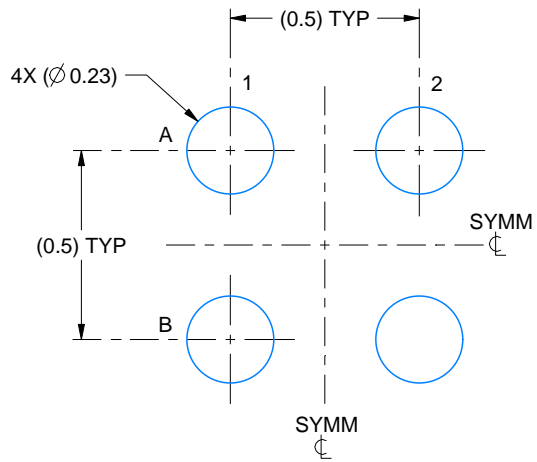

LAND PATTERN EXAMPLE
EXPOSED METAL SHOWN
SCALE:50X

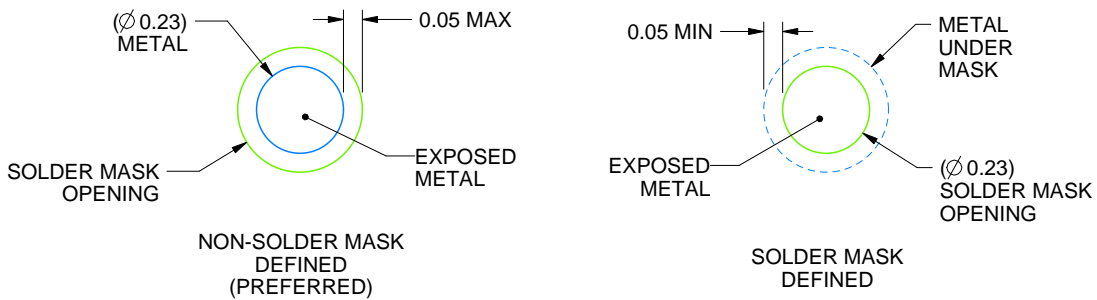

SOLDER MASK DETAILS
NOT TO SCALE

4219477/A 05/2017

NOTES: (continued)

- Final dimensions may vary due to manufacturing tolerance considerations and also routing constraints. Refer to Texas Instruments Literature No. SNVA009 (www.ti.com/lit/snva009).

EXAMPLE STENCIL DESIGN

YZT0004

DSBGA - 0.625 mm max height

DIE SIZE BALL GRID ARRAY

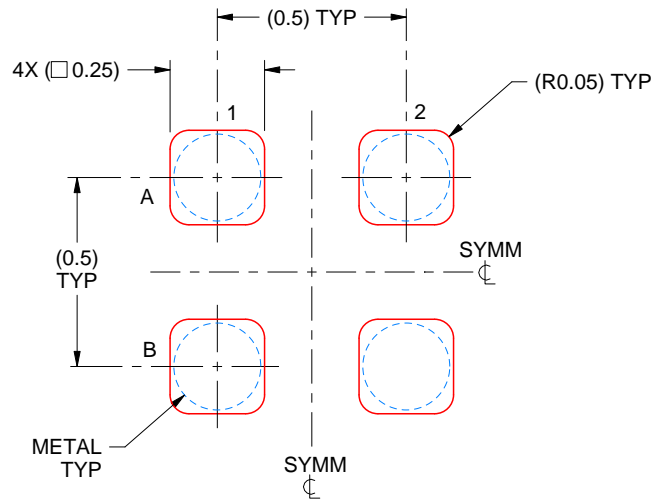

SOLDER PASTE EXAMPLE
BASED ON 0.1 mm THICK STENCIL
SCALE:50X

4219477/A 05/2017

NOTES: (continued)

4. Laser cutting apertures with trapezoidal walls and rounded corners may offer better paste release.

IMPORTANT NOTICE AND DISCLAIMER

TI PROVIDES TECHNICAL AND RELIABILITY DATA (INCLUDING DATASHEETS), DESIGN RESOURCES (INCLUDING REFERENCE DESIGNS), APPLICATION OR OTHER DESIGN ADVICE, WEB TOOLS, SAFETY INFORMATION, AND OTHER RESOURCES "AS IS" AND WITH ALL FAULTS, AND DISCLAIMS ALL WARRANTIES, EXPRESS AND IMPLIED, INCLUDING WITHOUT LIMITATION ANY IMPLIED WARRANTIES OF MERCHANTABILITY, FITNESS FOR A PARTICULAR PURPOSE OR NON-INFRINGEMENT OF THIRD PARTY INTELLECTUAL PROPERTY RIGHTS.

These resources are intended for skilled developers designing with TI products. You are solely responsible for (1) selecting the appropriate TI products for your application, (2) designing, validating and testing your application, and (3) ensuring your application meets applicable standards, and any other safety, security, or other requirements. These resources are subject to change without notice. TI grants you permission to use these resources only for development of an application that uses the TI products described in the resource. Other reproduction and display of these resources is prohibited. No license is granted to any other TI intellectual property right or to any third party intellectual property right. TI disclaims responsibility for, and you will fully indemnify TI and its representatives against, any claims, damages, costs, losses, and liabilities arising out of your use of these resources.

TI's products are provided subject to TI's Terms of Sale (www.ti.com/legal/termsofsale.html) or other applicable terms available either on ti.com or provided in conjunction with such TI products. TI's provision of these resources does not expand or otherwise alter TI's applicable warranties or warranty disclaimers for TI products.

Mailing Address: Texas Instruments, Post Office Box 655303, Dallas, Texas 75265
Copyright © 2019, Texas Instruments Incorporated