

3-V TO 6-V INPUT, 3-A OUTPUT SYNCHRONOUS-BUCK PWM SWITCHER WITH INTEGRATED FETs (SWIFT™)

FEATURES

- Qualified for Automotive Applications
- 60-mΩ MOSFET Switches for High Efficiency at 3-A Continuous Output Source or Sink Current
- 0.9-V to 3.3-V Adjustable Output Voltage With 1% Accuracy
- Externally Compensated for Design Flexibility
- Fast Transient Response
- Wide PWM Frequency: Fixed 350 kHz, 550 kHz, or Adjustable 280 kHz to 700 kHz
- Load Protected by Peak Current Limit and Thermal Shutdown
- Integrated Solution Reduces Board Area and Total Cost

APPLICATIONS

- Point of Load Regulation for High Performance DSPs, FPGAs, ASICs, and Microprocessors
- Automotive Systems
 - Navigation Units
 - Entertainment Modules
 - Satellite Radio
- Industrial High-Density Systems With Power Distributed at 5 V or 3.3 V

DESCRIPTION

As members of the SWIFT family of dc/dc regulators, the TPS54310 low-input-voltage high-output-current synchronous-buck PWM converter integrates all required active components. Included on the substrate with the listed features are a true, high-performance, voltage error amplifier that provides high performance under transient conditions, an undervoltage-lockout circuit to prevent start up until the input voltage reaches 3 V, an internally and externally set slow-start circuit to limit in-rush currents, and a power good output useful for processor/logic reset, fault signaling, and supply sequencing.

The TPS54310 device is available in a thermally enhanced 20-pin TSSOP (PWP) PowerPAD™ package, which eliminates bulky heatsinks. Texas Instruments provides evaluation modules and the SWIFT designer software tool to aid in quickly achieving high-performance power supply designs to meet aggressive equipment development cycles.

ORDERING INFORMATION†

T_J	OUTPUT VOLTAGE	PACKAGED DEVICES PLASTIC HTSSOP (PWP)‡§
–40°C to 125°C	Adjustable down to 0.9 V	TPS54310QPWRQ1

†For the most current package and ordering information, see the Package Option Addendum at the end of this document, or see the TI web site at <http://www.ti.com>.

‡Package drawings, thermal data, and symbolization are available at <http://www.ti.com/packaging>.

§The PWP package is taped and reeled as indicated by the R suffix to the device type (i.e., TPS54310QPWRQ1). See the Application section of the data sheet for PowerPAD drawing and layout information.



Please be aware that an important notice concerning availability, standard warranty, and use in critical applications of Texas Instruments semiconductor products and disclaimers thereto appears at the end of this data sheet.

PowerPAD and SWIFT are trademarks of Texas Instruments.

TPS54310-Q1

SGLS280D – JANUARY 2005 – REVISED JUNE 2009



These devices have limited built-in ESD protection. The leads should be shorted together or the device placed in conductive foam during storage or handling to prevent electrostatic damage to the MOS gates.

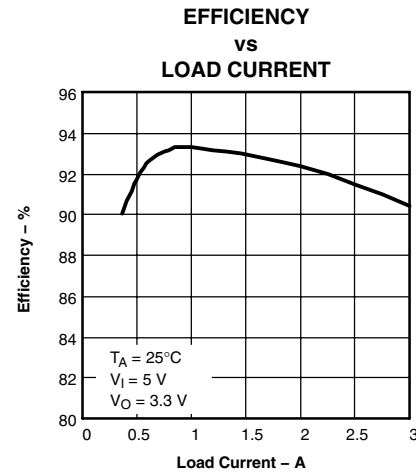
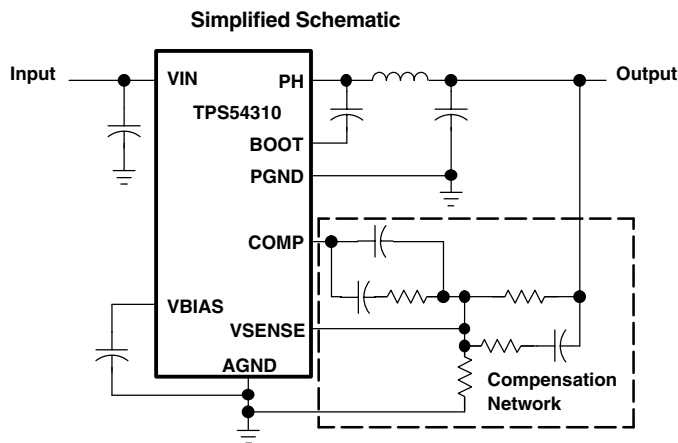

ABSOLUTE MAXIMUM RATINGS

over operating free-air temperature range unless otherwise noted⁽¹⁾

		TPS54310-Q1	UNIT
Input voltage range, V_I	VIN, SS/ENA, FSEL	-0.3 to 7	V
	RT	-0.3 to 6	V
	VSENSE	-0.3 to 4	V
	BOOT	-0.3 to 17	V
Output voltage range, V_O	VBIAS, PWRGD, COMP	-0.3 to 7	V
	PH	-0.6 to 10	V
Source current, I_O	PH	Internally Limited	
	COMP, VBIAS	6	mA
Sink current	PH	6	A
	COMP	6	mA
	SS/ENA, PWRGD	10	mA
Voltage differential	AGND to PGND	± 0.3	V
Continuous power dissipation	See Power Dissipation Rating Table		
Operating virtual junction temperature range, T_J	-40 to 150		$^\circ\text{C}$
Storage temperature, T_{stg}	-65 to 150		$^\circ\text{C}$
Lead temperature 1,6 mm (1/16 inch) from case for 10 seconds	300		$^\circ\text{C}$

⁽¹⁾ Stresses beyond those listed under "absolute maximum ratings" may cause permanent damage to the device. These are stress ratings only, and functional operation of the device at these or any other conditions beyond those indicated under "recommended operating conditions" is not implied. Exposure to absolute-maximum-rated conditions for extended periods may affect device reliability.

RECOMMENDED OPERATING CONDITIONS

	MIN	NOM	MAX	UNIT
Input voltage range, V_I	3		6	V
Operating junction temperature, T_J	-40		125	°C

PACKAGE DISSIPATION RATINGS⁽¹⁾ (2)

PACKAGE	THERMAL IMPEDANCE JUNCTION-TO-AMBIENT	$T_A = 25^\circ\text{C}$ POWER RATING	$T_A = 70^\circ\text{C}$ POWER RATING	$T_A = 85^\circ\text{C}$ POWER RATING
20-pin PWP with solder	26°C/W	3.85 W ⁽³⁾	2.12 W	1.54 W
20-pin PWP without solder	57.5°C/W	1.73 W	0.96 W	0.69 W

(1) For more information on the PWP package, see the Texas Instruments technical brief (SLMA002).

(2) Test board conditions:

1. 3" × 3", 2 layers, Thickness: 0.062"
2. 1.5 oz copper traces located on the top of the PCB
3. 1.5 oz copper ground plane on the bottom of the PCB
4. Ten thermal vias (see the recommended land pattern in application section of this data sheet)

(3) Maximum power dissipation may be limited by overcurrent protection.

TPS54310-Q1

SGLS280D – JANUARY 2005 – REVISED JUNE 2009

ELECTRICAL CHARACTERISTICS

 $T_J = -40^{\circ}\text{C}$ to 125°C , $V_{IN} = 3\text{ V}$ to 6 V (unless otherwise noted)

PARAMETER		TEST CONDITIONS	MIN	TYP	MAX	UNIT
SUPPLY VOLTAGE, V_{IN}						
VIN input voltage range			3		6	V
Quiescent current		$f_s = 350\text{ kHz}$, FSEL $\leq 0.8\text{ V}$, RT open, phase pin open		6.2	9.6	mA
		$f_s = 550\text{ kHz}$, FSEL $\geq 2.5\text{ V}$, RT open, phase pin open		8.4	12.8	
		Shutdown, SS/ENA = 0 V		1	1.4	
UNDER VOLTAGE LOCK OUT						
Start threshold voltage, UVLO				2.95	3	V
Stop threshold voltage, UVLO			2.7	2.8		
Hysteresis voltage, UVLO				0.16		V
Rising and falling edge deglitch, UVLO ⁽¹⁾				2.5		μs
BIAS VOLTAGE						
V_O	Output voltage, VBIAS	$I_{(VBIAS)} = 0$	2.7	2.8	2.95	V
	Output current, VBIAS ⁽²⁾				100	μA
CUMULATIVE REFERENCE						
V_{ref}	Accuracy ⁽¹⁾		0.882	0.891	0.900	V
REGULATION						
Line regulation ^{(1) (3)}		$I_L = 1.5\text{ A}$, $f_s = 350\text{ kHz}$, $T_J = 125^{\circ}\text{C}$			0.07	%V
		$I_L = 1.5\text{ A}$, $f_s = 550\text{ kHz}$, $T_J = 125^{\circ}\text{C}$			0.07	
Load regulation ^{(1) (3)}		$I_L = 0\text{ A}$ to 3 A , $f_s = 350\text{ kHz}$, $T_J = 125^{\circ}\text{C}$			0.03	%A
		$I_L = 0\text{ A}$ to 3 A , $f_s = 550\text{ kHz}$, $T_J = 125^{\circ}\text{C}$			0.03	
OSCILLATOR						
Internally set free-running frequency range		FSEL $\leq 0.8\text{ V}$, RT open	265	350	440	kHz
		FSEL $\geq 2.5\text{ V}$, RT open	415	550	680	
Externally set free-running frequency range		RT = 180 k Ω (1% resistor to AGND) ⁽¹⁾	252	280	308	kHz
		RT = 160 k Ω (1% resistor to AGND)	290	312	350	
		RT = 68 k Ω (1% resistor to AGND) ⁽¹⁾	663	700	762	
High-level threshold voltage, FSEL			2.5			V
Low-level threshold voltage, FSEL					0.8	V
Pulse duration, FSEL ⁽¹⁾			50			ns
Frequency range, FSEL ^{(1) (4)}			330		700	kHz
Ramp valley ⁽¹⁾				0.75		V
Ramp amplitude (peak-to-peak) ⁽¹⁾				1		V
Minimum controllable on time ⁽¹⁾					200	ns
Maximum duty cycle ⁽¹⁾			90%			

⁽¹⁾ Specified by design

⁽²⁾ Static resistive loads only

⁽³⁾ Specified by the circuit used in Figure 10.

⁽⁴⁾ To ensure proper operation when RC filter is used between external clock and FSEL pin, the recommended values are $R \leq 1\text{ k}\Omega$ and $C \leq 120\text{ pF}$.

ELECTRICAL CHARACTERISTICS (continued)

T_J = -40°C to 125°C, V_{IN} = 3 V to 6 V (unless otherwise noted)

PARAMETER		TEST CONDITIONS	MIN	TYP	MAX	UNIT
ERROR AMPLIFIER						
	Error amplifier open loop voltage gain	1-kΩ COMP to AGND ⁽¹⁾	90	110		dB
	Error amplifier unity gain bandwidth	Parallel 10 kΩ, 160 pF COMP to AGND ⁽¹⁾	3	5		MHz
	Error amplifier common-mode input voltage range	Powered by internal LDO ⁽¹⁾	0		VBIAS	V
I _{IB}	Input bias current, VSENSE ⁽¹⁾	VSENSE = V _{ref}		60	250	nA
V _O	Output voltage slew rate (symmetric), COMP ⁽¹⁾		1	1.4		V/μs
PWM COMPARATOR						
	PWM comparator propagation delay time, PWM comparator input to PH pin (excluding dead time)	10-mV overdrive ⁽¹⁾		70	85	ns
SLOW-START/ENABLE						
	Enable threshold voltage, SS/ENA		0.82	1.2	1.4	V
	Enable hysteresis voltage, SS/ENA ⁽¹⁾			0.03		V
	Falling edge deglitch, SS/ENA ⁽¹⁾			2.5		μs
	Internal slow-start time ⁽¹⁾		2.6	3.35	4.1	ms
	Charge current, SS/ENA	SS/ENA = 0 V	2.5	5	8	μA
	Discharge current, SS/ENA	SS/ENA = 0.2 V, V _I = 2.7 V	1.2	2.3	4	mA
POWER GOOD						
	Power good threshold voltage	VSENSE falling		90		%V _{ref}
	Power good hysteresis voltage ⁽¹⁾			3		%V _{ref}
	Power good falling edge deglitch ⁽¹⁾			35		μs
	Output saturation voltage, PWRGD	I _(sink) = 2.5 mA		0.18	0.3	V
	Leakage current, PWRGD	V _I = 5.5 V			1	μA
CURRENT LIMIT						
	Current limit trip point	V _I = 3 V, output shorted ⁽¹⁾	4	6.5		A
		V _I = 6 V, output shorted ⁽¹⁾	4.5	7.5		
	Current limit leading edge blanking time			100		ns
	Current limit total response time			200		ns
THERMAL SHUTDOWN						
	Thermal shutdown trip point ⁽¹⁾		135	150	165	°C
	Thermal shutdown hysteresis ⁽¹⁾			10		°C
OUTPUT POWER MOSFETS						
r _{DS(on)}	Power MOSFET switches	I _O = 3 A, V _I = 6 V ⁽²⁾		59	88	mΩ
		I _O = 3 A, V _I = 3 V ⁽²⁾		85	136	

(1) Specified by design

(2) Matched MOSFETs, low side r_{DS(on)} production tested, high side r_{DS(on)} specified by design

TPS54310-Q1

SGLS280D – JANUARY 2005 – REVISED JUNE 2009

PIN ASSIGNMENTS

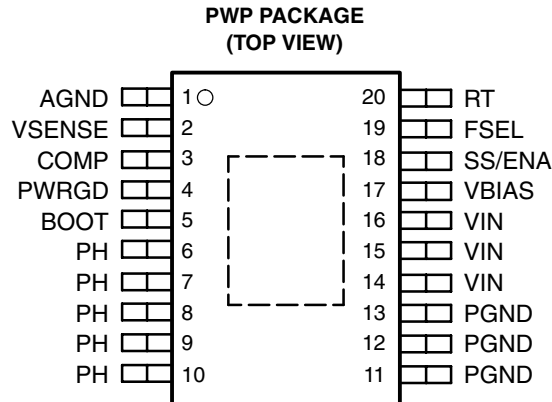

Terminal Functions

TERMINAL		DESCRIPTION
NAME	NO.	
AGND	1	Analog ground. Return for compensation network/output divider, slow-start capacitor, VBIAS capacitor, RT resistor, and FSEL pin. Make PowerPAD connection to AGND.
BOOT	5	Bootstrap input. A 0.022- μ F to 0.1- μ F low-ESR capacitor connected from BOOT to PH generates floating drive for the high-side FET driver.
COMP	3	Error amplifier output. Connect the compensation network from COMP to VSENSE.
PGND	11–13	Power ground. High current return for the low-side driver and power MOSFET. Connect PGND with large copper areas to the input and output supply returns and negative terminals of the input and output capacitors.
PH	6–10	Phase input/output. Junction of the internal high and low-side power MOSFETs and output inductor.
PWRGD	4	Power good open drain output. High when $V_{SENSE} \geq 90\% V_{ref}$, otherwise PWRGD is low. Note that output is low when SS/ENA is low or internal shutdown signal active.
RT	20	Frequency setting resistor input. Connect a resistor from RT to AGND to set the switching frequency, f_s .
SS/ENA	18	Slow-start/enable input/output. Dual function pin which provides logic input to enable/disable device operation and capacitor input to externally set the start-up time.
FSEL	19	Synchronization input. Dual function pin which provides logic input to synchronize to an external oscillator or pin select between two internally set switching frequencies. When used to synchronize to an external signal, a resistor must be connected to the RT pin.
VBIAS	17	Internal bias regulator output. Supplies regulated voltage to internal circuitry. Bypass VBIAS pin to AGND pin with a high quality, low ESR 0.1- μ F to 1- μ F ceramic capacitor.
VIN	14–16	Input supply for the power MOSFET switches and internal bias regulator. Bypass VIN pins to PGND pins close to the device package with a high quality, low ESR 1- μ F to 10- μ F ceramic capacitor.
VSENSE	2	Error amplifier inverting input.

FUNCTIONAL BLOCK DIAGRAM

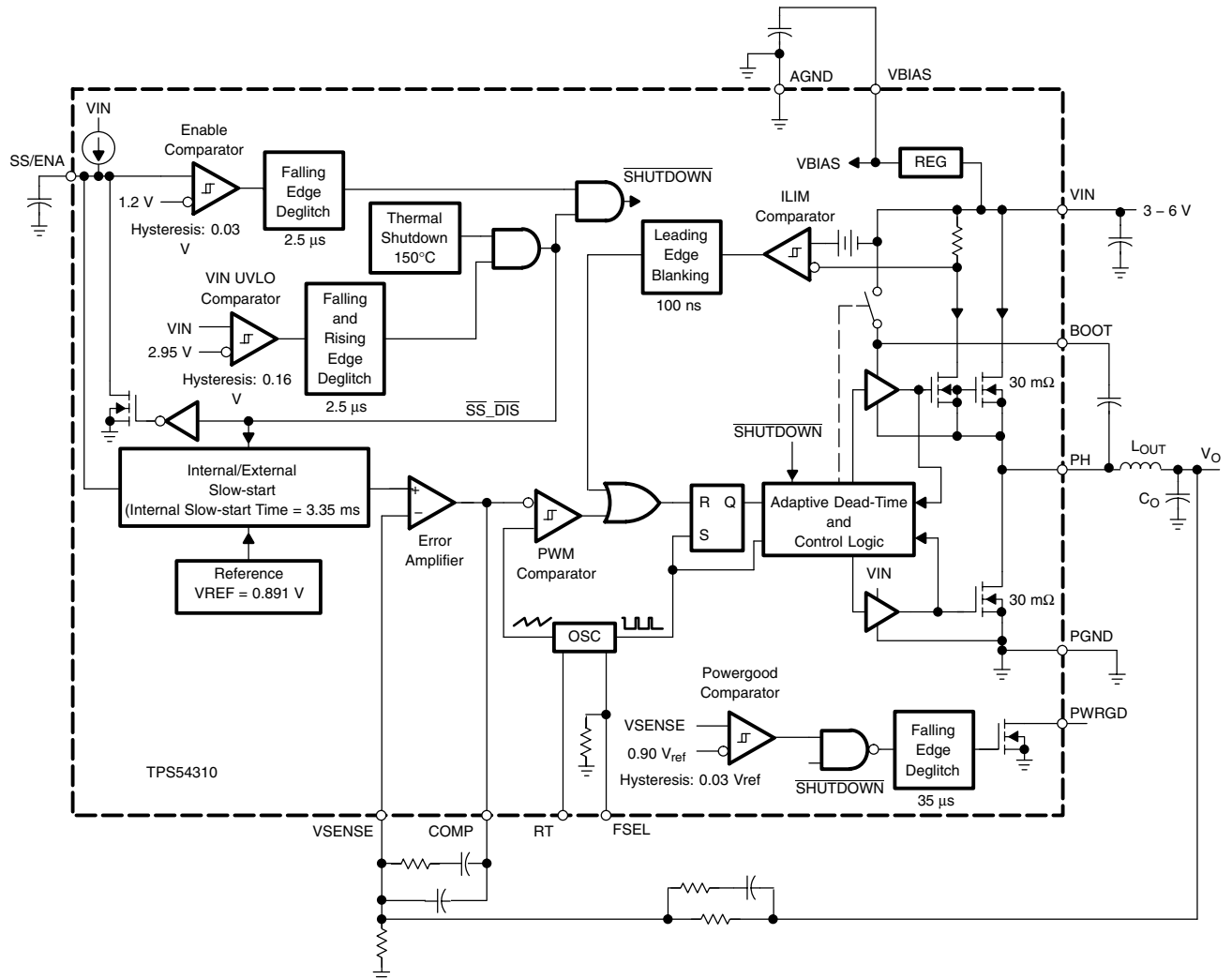

ADDITIONAL 3-A SWIFT DEVICES

DEVICE	OUTPUT VOLTAGE	DEVICE	OUTPUT VOLTAGE	DEVICE	OUTPUT VOLTAGE
TPS54311	0.9 V	TPS54313	1.5 V	TPS54315	2.5 V
TPS54312	1.2 V	TPS54314	1.8 V	TPS54316	3.3 V

RELATED DC/DC PRODUCTS

- UCC3585—dc/dc controller
- PT5500 series—3-A plug-in modules
- TPS757XX—3-A low dropout regulator

TYPICAL CHARACTERISTICS

DRAIN-SOURCE ON-STATE RESISTANCE
vs
JUNCTION TEMPERATURE

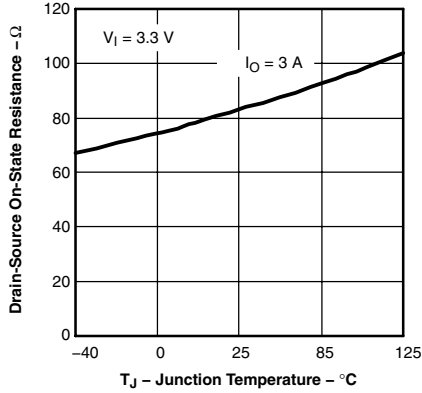

Figure 1

DRAIN-SOURCE ON-STATE RESISTANCE
vs
JUNCTION TEMPERATURE

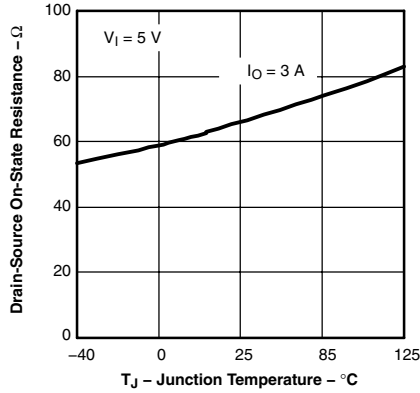

Figure 2

INTERNALLY SET OSCILLATOR
FREQUENCY
vs
JUNCTION TEMPERATURE

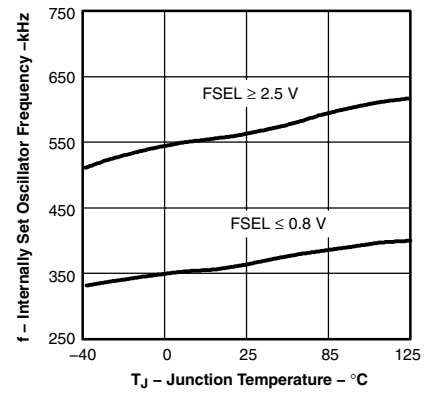

Figure 3

EXTERNALLY SET OSCILLATOR
FREQUENCY
vs
JUNCTION TEMPERATURE

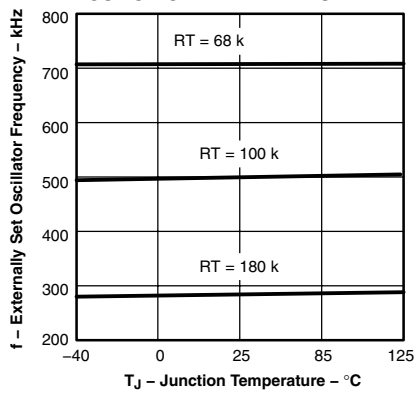

Figure 4

VOLTAGE REFERENCE
vs
JUNCTION TEMPERATURE

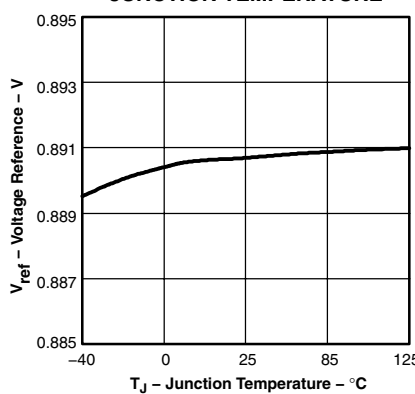

Figure 5

OUTPUT VOLTAGE REGULATION
vs
INPUT VOLTAGE

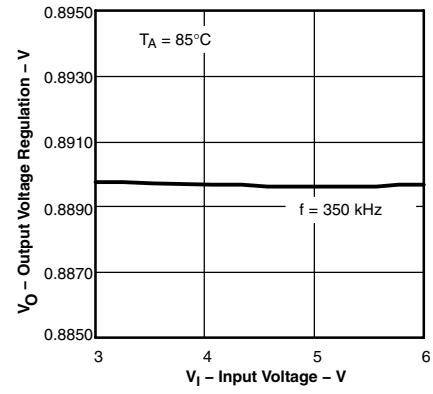

Figure 6

ERROR AMPLIFIER
OPEN LOOP RESPONSE

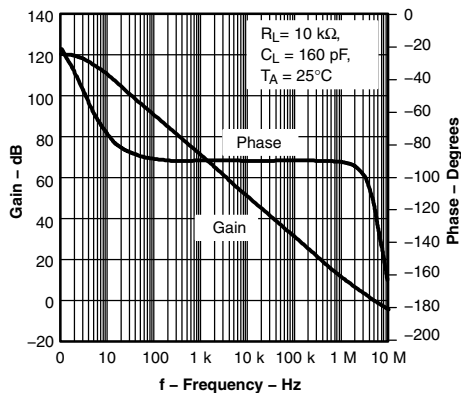

Figure 7

INTERNAL SLOW-START TIME
vs
JUNCTION TEMPERATURE

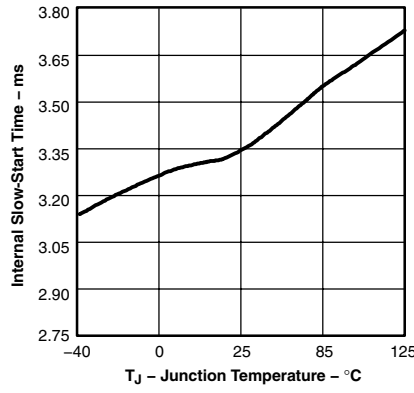

Figure 8

DEVICE POWER LOSSES
vs
LOAD CURRENT

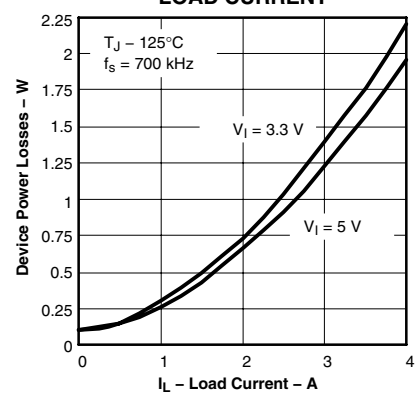

Figure 9

APPLICATION INFORMATION

Figure 10 shows the schematic diagram for a typical TPS54310 application. The TPS54310 (U1) can provide up to 3 A of output current at a nominal output voltage of

3.3 V. For proper thermal performance, the power pad underneath the TPS54310 integrated circuit needs to be soldered well to the printed circuit board.

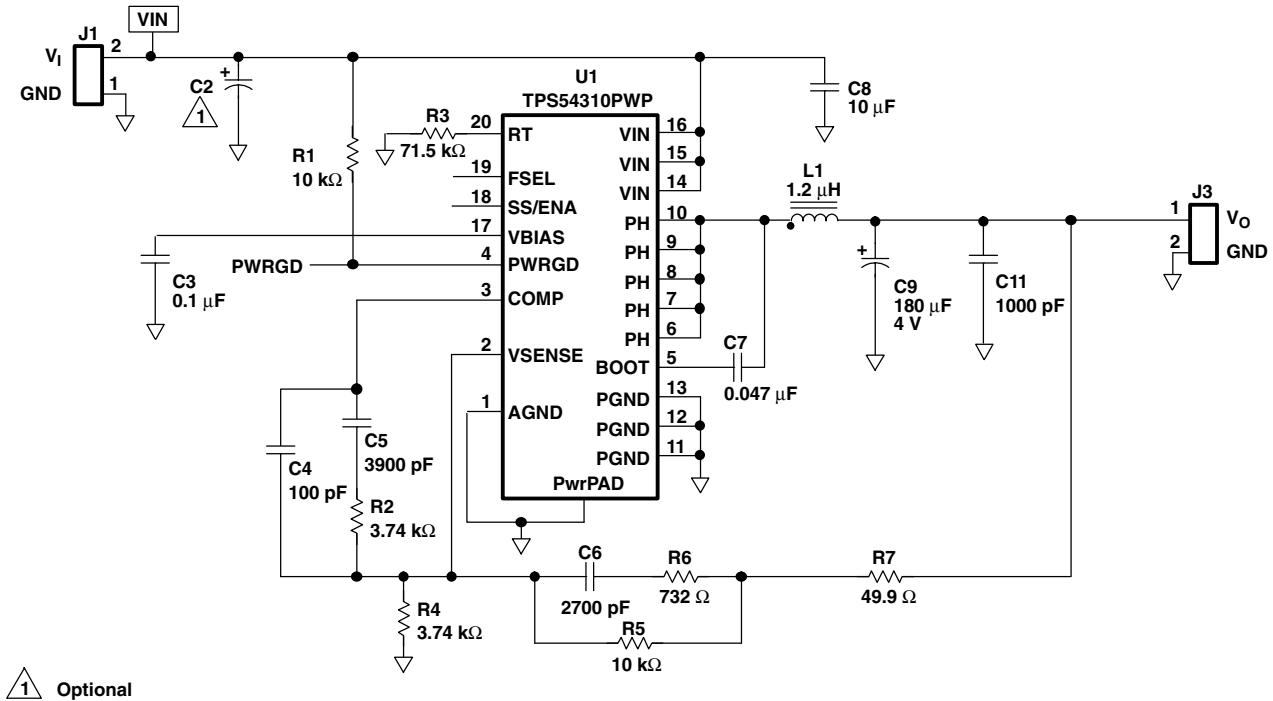

Figure 10. TPS54310 Schematic

INPUT VOLTAGE

The input to the circuit is a nominal 5 VDC, applied at J1. The optional input filter (C2) is a 220-μF POSCAP capacitor, with a maximum allowable ripple current of 3 A. C8 is the decoupling capacitor for the TPS54310 and must be located as close to the device as possible.

FEEDBACK CIRCUIT

The resistor divider network of R5 and R4 sets the output voltage for the circuit at 3.3 V. R5, along with R2, R6, C4, C5, and C6 forms the loop compensation network for the circuit. For this design, a Type 3 topology is used.

OPERATING FREQUENCY

In the application circuit, the 350-kHz operation is selected by leaving RT and FSEL open. Connecting a 68-kΩ to 180-kΩ resistor between RT (pin 20) and analog ground can be used to set the switching frequency from 280 kHz to 700 kHz. To calculate the RT resistor, use equation 1:

$$R = \frac{100 \text{ k}\Omega}{f_{\text{SW}}} \times 500 \text{ kHz} \quad (1)$$

OUTPUT FILTER

The output filter is composed of a 1.2-μH inductor and 180-μF capacitor. The inductor is a low dc-resistance (0.017 Ω) type, Coilcraft DO1813P-122HC. The capacitor used is a 4-V special polymer type with a maximum ESR of 0.015 Ω. The feedback loop is compensated so that the unity gain frequency is approximately 75 kHz.

GROUNDING AND PowerPAD LAYOUT

The TPS54310 has two internal grounds (analog and power). Inside the TPS54310, the analog ground ties to all of the noise sensitive signals, while the power ground ties to the noisier power signals. The PowerPAD must be tied directly to AGND. Noise injected between the two grounds can degrade the performance of the TPS54310, particularly at higher output currents. However, ground noise on an analog ground plane can also cause problems with some of the control and bias signals. For these reasons, separate analog and power ground planes are recommended. These two planes should tie together directly at the IC to reduce noise between the two grounds. The only components that should tie directly to the power ground plane are the input capacitor, the output capacitor, the input voltage decoupling capacitor, and the PGND pins of the TPS54310. The layout of the TPS54310 evaluation module is representative of a recommended layout for a

TPS54310-Q1

SGLS280D – JANUARY 2005 – REVISED JUNE 2009

2-layer board. Documentation for the TPS54310 evaluation module can be found on the Texas Instruments web site under the TPS54310 product folder and in the application note (SLVA109).

LAYOUT CONSIDERATIONS FOR THERMAL PERFORMANCE

For operation at full rated load current, the analog ground plane must provide adequate heat dissipating area. A 3 inch by 3 inch plane of 1 ounce copper is recommended, though not mandatory, depending on ambient temperature and airflow. Most applications have larger areas of internal

ground plane available and the PowerPAD should be connected to the largest area available. Additional areas on the top or bottom layers also help dissipate heat, and any area available should be used when 3 A or greater operation is desired. Connection from the exposed area of the PowerPAD to the analog ground plane layer should be made using 0.013 inch diameter vias to avoid solder wicking through the vias. Six vias should be in the PowerPAD area with four additional vias located under the device package. The size of the vias under the package, but not in the exposed thermal pad area, can be increased to 0.018. Additional vias beyond the 10 recommended that enhance thermal performance should be included in areas not under the device package.

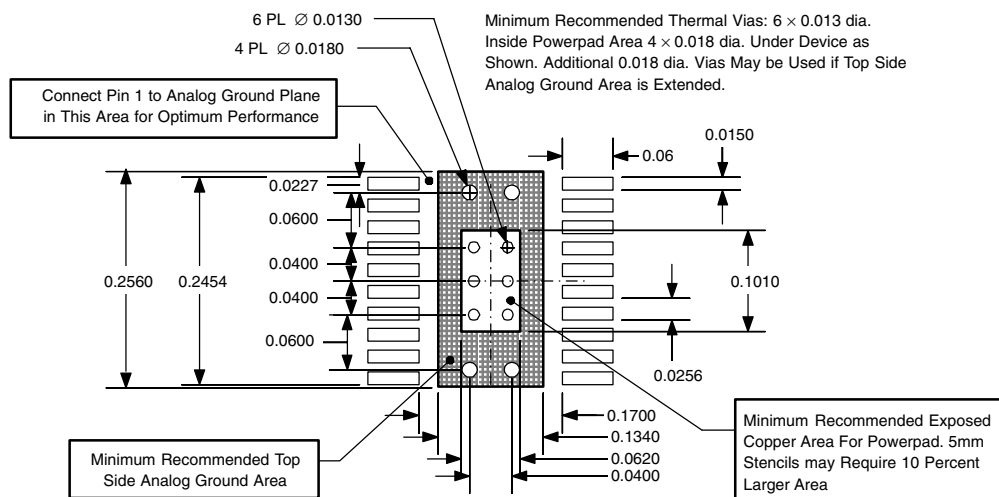

Figure 11. Recommended Land Pattern for 20-Pin PWP PowerPAD

PERFORMANCE GRAPHS

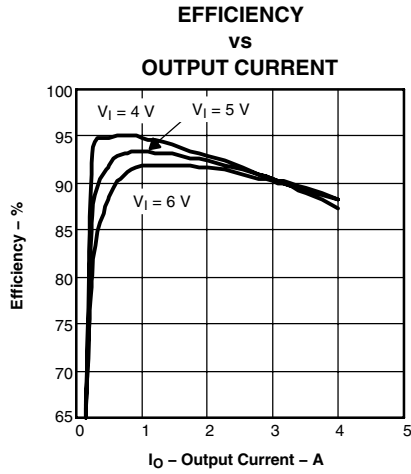

Figure 12

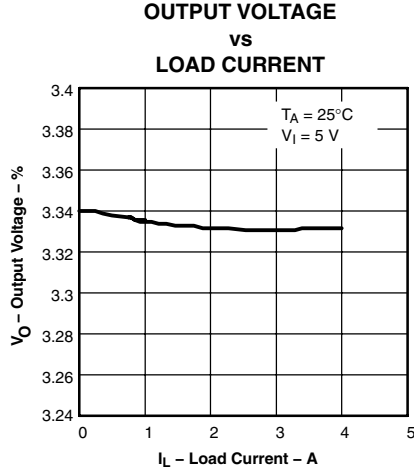

Figure 13

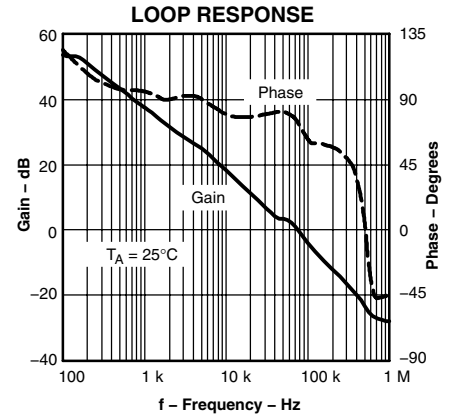

Figure 14

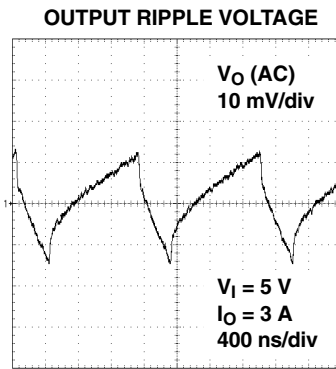

Figure 15

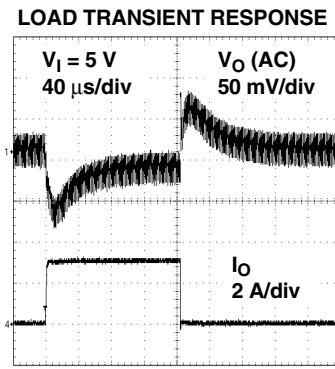

Figure 16

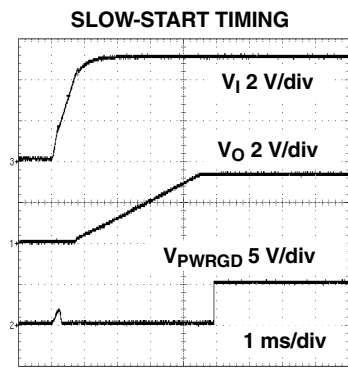
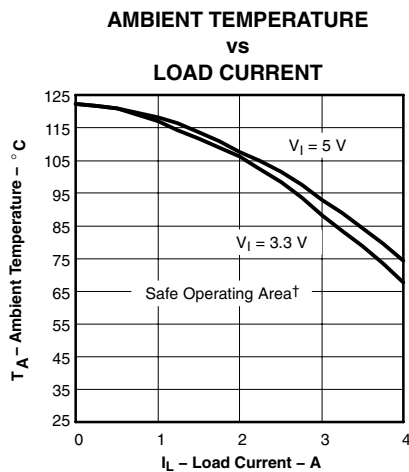

Figure 17



† The safe operating area is applicable to the test board conditions listed in the *Dissipation Rating Table* section of this data sheet.

Figure 18

DETAILED DESCRIPTION

Under Voltage Lock Out (UVLO)

The TPS54310 incorporates an under voltage lockout circuit to keep the device disabled when the input voltage (VIN) is insufficient. During power up, internal circuits are held inactive until VIN exceeds the nominal UVLO threshold voltage of 2.95 V. Once the UVLO start threshold is reached, device start-up begins. The device operates until VIN falls below the nominal UVLO stop threshold of 2.8 V. Hysteresis in the UVLO comparator and a 2.5-μs rising and falling edge deglitch circuit reduce the likelihood of shutting the device down due to noise on VIN.

Slow-Start/Enable (SS/ENA)

The slow-start/enable pin provides two functions; first, the pin acts as an enable (shutdown) control by keeping the device turned off until the voltage exceeds the start threshold voltage of approximately 1.2 V. When SS/ENA exceeds the enable threshold, device start up begins. The reference voltage fed to the error amplifier is linearly ramped up from 0 V to 0.891 V in 3.35 ms. Similarly, the converter output voltage reaches regulation in approximately 3.35 ms. Voltage hysteresis and a 2.5-μs falling edge deglitch circuit reduce the likelihood of triggering the enable due to noise.

The second function of the SS/ENA pin provides an external means of extending the slow-start time with a low-value capacitor connected between SS/ENA and AGND. Adding a capacitor to the SS/ENA pin has two effects on start-up. First, a delay occurs between release of the SS/ENA pin and start up of the output. The delay is proportional to the slow-start capacitor value and lasts until the SS/ENA pin reaches the enable threshold. The start-up delay is approximately:

$$t_d = C_{(SS)} \times \frac{1.2 \text{ V}}{5 \mu\text{A}} \quad (2)$$

Second, as the output becomes active, a brief ramp-up at the internal slow-start rate may be observed before the externally set slow-start rate takes control and the output rises at a rate proportional to the slow-start capacitor. The slow-start time set by the capacitor is approximately:

$$t_{(SS)} = C_{(SS)} \times \frac{0.7 \text{ V}}{5 \mu\text{A}} \quad (3)$$

The actual slow-start is likely to be less than the above approximation due to the brief ramp-up at the internal rate.

VBIAS Regulator (VBIAS)

The VBIAS regulator provides internal analog and digital blocks with a stable supply voltage over variations in junction temperature and input voltage. A high quality, low-ESR, ceramic bypass capacitor is required on the

VBIAS pin. X7R or X5R grade dielectrics are recommended because their values are more stable over temperature. The bypass capacitor should be placed close to the VBIAS pin and returned to AGND. External loading on VBIAS is allowed, with the caution that internal circuits require a minimum VBIAS of 2.7 V, and external loads on VBIAS with ac or digital switching noise may degrade performance. The VBIAS pin may be useful as a reference voltage for external circuits.

Voltage Reference

The voltage reference system produces a precise V_{ref} signal by scaling the output of a temperature stable bandgap circuit. During manufacture, the bandgap and scaling circuits are trimmed to produce 0.891 V at the output of the error amplifier, with the amplifier connected as a voltage follower. The trim procedure adds to the high precision regulation of the TPS54310, since it cancels offset errors in the scale and error amplifier circuits.

Oscillator and PWM Ramp

The oscillator frequency can be set to internally fixed values of 350 kHz or 550 kHz using the FSEL pin as a static digital input. If a different frequency of operation is required for the application, the oscillator frequency can be externally adjusted from 280 kHz to 700 kHz by connecting a resistor to the RT pin to ground and floating the FSEL pin. The switching frequency is approximated by the following equation, where R is the resistance from RT to AGND:

$$\text{SWITCHING FREQUENCY} = \frac{100 \text{ k}\Omega}{R} \times 500 \text{ kHz} \quad (4)$$

External synchronization of the PWM ramp is possible over the frequency range of 330 kHz to 700 kHz by driving a synchronization signal into FSEL and connecting a resistor from RT to AGND. Choose an RT resistor that sets the free-running frequency to 80% of the synchronization signal. Table 1 summarizes the frequency selection configurations.

Table 1. Summary of the Frequency Selection Configurations

SWITCHING FREQUENCY	FSEL PIN	RT PIN
350 kHz, internally set	Float or AGND	Float
550 kHz, internally set	≥ 2.5 V	Float
Externally set 280 kHz to 700 kHz	Float	R = 68 kΩ to 180 kΩ
Externally synchronized frequency ⁽¹⁾	Synchronization signal	R = RT value for 80% of external synchronization frequency

(1) To ensure proper operation when RC filter is used between external clock and FSEL pin, the recommended values are $R \leq 1 \text{ k}\Omega$ and $C \leq 120 \text{ pF}$.

Error Amplifier

The high performance, wide bandwidth, voltage error amplifier sets the TPS54310 apart from most dc/dc converters. The user is given the flexibility to use a wide range of output L and C filter components to suit the particular application needs. Type 2 or Type 3 compensation can be employed using external compensation components.

PWM Control

Signals from the error amplifier output, oscillator, and current limit circuit are processed by the PWM control logic. Referring to the internal block diagram, the control logic includes the PWM comparator, OR gate, PWM latch, and portions of the adaptive dead-time and control logic block. During steady-state operation below the current limit threshold, the PWM comparator output and oscillator pulse train alternately reset and set the PWM latch. Once the PWM latch is set, the low-side FET remains on for a minimum duration set by the oscillator pulse duration. During this period, the PWM ramp discharges rapidly to its valley voltage. When the ramp begins to charge back up, the low-side FET turns off and high-side FET turns on. As the PWM ramp voltage exceeds the error amplifier output voltage, the PWM comparator resets the latch, thus turning off the high-side FET and turning on the low-side FET. The low-side FET remains on until the next oscillator pulse discharges the PWM ramp.

During transient conditions, the error amplifier output could be below the PWM ramp valley voltage or above the PWM peak voltage. If the error amplifier is high, the PWM latch is never reset and the high-side FET remains on until the oscillator pulse signals the control logic to turn the high-side FET off and the low-side FET on. The device operates at its maximum duty cycle until the output voltage rises to the regulation set-point, setting VSENSE to approximately the same voltage as V_{ref} . If the error amplifier output is low, the PWM latch is continually reset and the high-side FET does not turn on. The low-side FET remains on until the VSENSE voltage decreases to a range that allows the PWM comparator to change states. The TPS54310 is capable of sinking current continuously until the output reaches the regulation set-point.

If the current limit comparator trips for longer than 100 ns, the PWM latch resets before the PWM ramp exceeds the error amplifier output. The high-side FET turns off and low-side FET turns on to decrease the energy in the output inductor and consequently the output current. This process is repeated each cycle in which the current limit comparator is tripped.

Dead-Time Control and MOSFET Drivers

Adaptive dead-time control prevents shoot-through current from flowing in both N-channel power MOSFETs during the switching transitions by actively controlling the

turn-on times of the MOSFET drivers. The high-side driver does not turn on until the gate drive voltage to the low-side FET is below 2 V. The low-side driver does not turn on until the voltage at the gate of the high-side MOSFETs is below 2 V. The high-side and low-side drivers are designed with 300-mA source and sink capability to quickly drive the power MOSFETs gates. The low-side driver is supplied from VIN, while the high-side drive is supplied from the BOOT pin. A bootstrap circuit uses an external BOOT capacitor and an internal 2.5- Ω bootstrap switch connected between the VIN and BOOT pins. The integrated bootstrap switch improves drive efficiency and reduces external component count.

Overcurrent Protection

The cycle by cycle current limiting is achieved by sensing the current flowing through the high-side MOSFET and differential amplifier and comparing it to the preset overcurrent threshold. The high-side MOSFET is turned off within 200 ns of reaching the current limit threshold. A 100-ns leading edge blanking circuit prevents false tripping of the current limit. Current limit detection occurs only when current flows from VIN to PH when sourcing current to the output filter. Load protection during current sink operation is provided by thermal shutdown.

Thermal Shutdown

The device uses the thermal shutdown to turn off the power MOSFETs and disable the controller if the junction temperature exceeds 150°C. The device is released from shutdown when the junction temperature decreases to 10°C below the thermal shutdown trip point and starts up under control of the slow-start circuit. Thermal shutdown provides protection when an overload condition is sustained for several milliseconds. With a persistent fault condition, the device cycles continuously; starting up by control of the soft-start circuit, heating up due to the fault, and then shutting down upon reaching the thermal shutdown point.

Power Good (PWRGD)

The power good circuit monitors for under voltage conditions on VSENSE. If the voltage on VSENSE is 10% below the reference voltage, the open-drain PWRGD output is pulled low. PWRGD is also pulled low if VIN is less than the UVLO threshold, or SS/ENA is low, or thermal shutdown is asserted. When VIN = UVLO threshold, SS/ENA = enable threshold, and VSENSE > 90% of V_{ref} , the open drain output of the PWRGD pin is high. A hysteresis voltage equal to 3% of V_{ref} and a 35- μ s falling edge deglitch circuit prevent tripping of the power good comparator due to high frequency noise.

PACKAGING INFORMATION

Orderable Device	Status (1)	Package Type	Package Drawing	Pins	Package Qty	Eco Plan (2)	Lead finish/ Ball material (6)	MSL Peak Temp (3)	Op Temp (°C)	Device Marking (4/5)	Samples
TPS54310QPWPRQ1	ACTIVE	HTSSOP	PWP	20	2000	RoHS & Green	NIPDAU	Level-3-260C-168 HR	-40 to 125	P54310Q1	Samples

(1) The marketing status values are defined as follows:

ACTIVE: Product device recommended for new designs.

LIFEBUY: TI has announced that the device will be discontinued, and a lifetime-buy period is in effect.

NRND: Not recommended for new designs. Device is in production to support existing customers, but TI does not recommend using this part in a new design.

PREVIEW: Device has been announced but is not in production. Samples may or may not be available.

OBSOLETE: TI has discontinued the production of the device.

(2) **RoHS:** TI defines "RoHS" to mean semiconductor products that are compliant with the current EU RoHS requirements for all 10 RoHS substances, including the requirement that RoHS substance do not exceed 0.1% by weight in homogeneous materials. Where designed to be soldered at high temperatures, "RoHS" products are suitable for use in specified lead-free processes. TI may reference these types of products as "Pb-Free".

RoHS Exempt: TI defines "RoHS Exempt" to mean products that contain lead but are compliant with EU RoHS pursuant to a specific EU RoHS exemption.

Green: TI defines "Green" to mean the content of Chlorine (Cl) and Bromine (Br) based flame retardants meet JS709B low halogen requirements of <=1000ppm threshold. Antimony trioxide based flame retardants must also meet the <=1000ppm threshold requirement.

(3) MSL, Peak Temp. - The Moisture Sensitivity Level rating according to the JEDEC industry standard classifications, and peak solder temperature.

(4) There may be additional marking, which relates to the logo, the lot trace code information, or the environmental category on the device.

(5) Multiple Device Markings will be inside parentheses. Only one Device Marking contained in parentheses and separated by a "-" will appear on a device. If a line is indented then it is a continuation of the previous line and the two combined represent the entire Device Marking for that device.

(6) Lead finish/Ball material - Orderable Devices may have multiple material finish options. Finish options are separated by a vertical ruled line. Lead finish/Ball material values may wrap to two lines if the finish value exceeds the maximum column width.

Important Information and Disclaimer: The information provided on this page represents TI's knowledge and belief as of the date that it is provided. TI bases its knowledge and belief on information provided by third parties, and makes no representation or warranty as to the accuracy of such information. Efforts are underway to better integrate information from third parties. TI has taken and continues to take reasonable steps to provide representative and accurate information but may not have conducted destructive testing or chemical analysis on incoming materials and chemicals. TI and TI suppliers consider certain information to be proprietary, and thus CAS numbers and other limited information may not be available for release.

In no event shall TI's liability arising out of such information exceed the total purchase price of the TI part(s) at issue in this document sold by TI to Customer on an annual basis.

OTHER QUALIFIED VERSIONS OF TPS54310-Q1 :

- Catalog: [TPS54310](#)
- Enhanced Product: [TPS54310-EP](#)

NOTE: Qualified Version Definitions:

- Catalog - TI's standard catalog product
- Enhanced Product - Supports Defense, Aerospace and Medical Applications

TAPE AND REEL INFORMATION

QUADRANT ASSIGNMENTS FOR PIN 1 ORIENTATION IN TAPE

*All dimensions are nominal

Device	Package Type	Package Drawing	Pins	SPQ	Reel Diameter (mm)	Reel Width W1 (mm)	A0 (mm)	B0 (mm)	K0 (mm)	P1 (mm)	W (mm)	Pin1 Quadrant
TPS54310QPWPRQ1	HTSSOP	PWP	20	2000	330.0	16.4	6.95	7.1	1.6	8.0	16.0	Q1

TAPE AND REEL BOX DIMENSIONS



*All dimensions are nominal

Device	Package Type	Package Drawing	Pins	SPQ	Length (mm)	Width (mm)	Height (mm)
TPS54310QPWPRQ1	HTSSOP	PWP	20	2000	350.0	350.0	43.0

MECHANICAL DATA

PWP (R-PDSO-G20)

PowerPAD™ PLASTIC SMALL OUTLINE



4073225-4/1 05/11

- NOTES:
- All linear dimensions are in millimeters.
 - This drawing is subject to change without notice.
 - Body dimensions do not include mold flash or protrusions. Mold flash and protrusion shall not exceed 0.15 per side.
 - This package is designed to be soldered to a thermal pad on the board. Refer to Technical Brief, PowerPad Thermally Enhanced Package, Texas Instruments Literature No. SLMA002 for information regarding recommended board layout. This document is available at www.ti.com <<http://www.ti.com>>.
 - See the additional figure in the Product Data Sheet for details regarding the exposed thermal pad features and dimensions.
 - Falls within JEDEC MO-153

PowerPAD is a trademark of Texas Instruments.

THERMAL PAD MECHANICAL DATA

PWP (R-PDSO-G20) PowerPAD™ SMALL PLASTIC OUTLINE

THERMAL INFORMATION

This PowerPAD™ package incorporates an exposed thermal pad that is designed to be attached to a printed circuit board (PCB). The thermal pad must be soldered directly to the PCB. After soldering, the PCB can be used as a heatsink. In addition, through the use of thermal vias, the thermal pad can be attached directly to the appropriate copper plane shown in the electrical schematic for the device, or alternatively, can be attached to a special heatsink structure designed into the PCB. This design optimizes the heat transfer from the integrated circuit (IC).

For additional information on the PowerPAD package and how to take advantage of its heat dissipating abilities, refer to Technical Brief, PowerPAD Thermally Enhanced Package, Texas Instruments Literature No. SLMA002 and Application Brief, PowerPAD Made Easy, Texas Instruments Literature No. SLMA004. Both documents are available at www.ti.com.

The exposed thermal pad dimensions for this package are shown in the following illustration.



Top View

Exposed Thermal Pad Dimensions

4206332-15/AO 01/16

NOTE: A. All linear dimensions are in millimeters

 Exposed tie strap features may not be present.

PowerPAD is a trademark of Texas Instruments

PWP (R-PDSO-G20)

PowerPAD™ PLASTIC SMALL OUTLINE



- NOTES:
- A. All linear dimensions are in millimeters.
 - B. This drawing is subject to change without notice.
 - C. Customers should place a note on the circuit board fabrication drawing not to alter the center solder mask defined pad.
 - D. This package is designed to be soldered to a thermal pad on the board. Refer to Technical Brief, PowerPad Thermally Enhanced Package, Texas Instruments Literature No. SLMA002, SLMA004, and also the Product Data Sheets for specific thermal information, via requirements, and recommended board layout. These documents are available at www.ti.com <<http://www.ti.com>>. Publication IPC-7351 is recommended for alternate designs.
 - E. Laser cutting apertures with trapezoidal walls and also rounding corners will offer better paste release. Customers should contact their board assembly site for stencil design recommendations. Example stencil design based on a 50% volumetric metal load solder paste. Refer to IPC-7525 for other stencil recommendations.
 - F. Customers should contact their board fabrication site for solder mask tolerances between and around signal pads.

IMPORTANT NOTICE AND DISCLAIMER

TI PROVIDES TECHNICAL AND RELIABILITY DATA (INCLUDING DATASHEETS), DESIGN RESOURCES (INCLUDING REFERENCE DESIGNS), APPLICATION OR OTHER DESIGN ADVICE, WEB TOOLS, SAFETY INFORMATION, AND OTHER RESOURCES "AS IS" AND WITH ALL FAULTS, AND DISCLAIMS ALL WARRANTIES, EXPRESS AND IMPLIED, INCLUDING WITHOUT LIMITATION ANY IMPLIED WARRANTIES OF MERCHANTABILITY, FITNESS FOR A PARTICULAR PURPOSE OR NON-INFRINGEMENT OF THIRD PARTY INTELLECTUAL PROPERTY RIGHTS.

These resources are intended for skilled developers designing with TI products. You are solely responsible for (1) selecting the appropriate TI products for your application, (2) designing, validating and testing your application, and (3) ensuring your application meets applicable standards, and any other safety, security, or other requirements. These resources are subject to change without notice. TI grants you permission to use these resources only for development of an application that uses the TI products described in the resource. Other reproduction and display of these resources is prohibited. No license is granted to any other TI intellectual property right or to any third party intellectual property right. TI disclaims responsibility for, and you will fully indemnify TI and its representatives against, any claims, damages, costs, losses, and liabilities arising out of your use of these resources.

TI's products are provided subject to TI's Terms of Sale (www.ti.com/legal/termsofsale.html) or other applicable terms available either on ti.com or provided in conjunction with such TI products. TI's provision of these resources does not expand or otherwise alter TI's applicable warranties or warranty disclaimers for TI products.

Mailing Address: Texas Instruments, Post Office Box 655303, Dallas, Texas 75265
Copyright © 2020, Texas Instruments Incorporated