

FEATURES

- Low Quiescent Current
- Very Low Dropout Voltage
- Excellent Line and Load Regulation
- Guaranteed Output Current of 300mA
- Fixed Output Voltage: 1.2V, 1.5V, 1.8V 2.5V, 2.8V, 3.0V, and 3.3V
- Logic Controlled Shutdown Option
- Stable with 1 μ F MLCC
- Output Auto Discharge Function
- Fast Turn-On Time
- Over Current Protection
- Over Temperature Protection
- Available in SOT-23-5L Package

APPLICATIONS

- Mobile Phones and Smart Phones
- Digital Cameras and Camcorders
- Portable Communication Devices
- GPS, PDAs and handhelds
- Battery-Powered Devices

DESCRIPTION

The TPS730xx is a series of 300mA high performance low dropout linear voltage regulator ideal for mobile or portable applications with high output voltage accuracy, very low quiescent current, and very low dropout voltage. The TPS730xx series include enable function to save power moreover it provides output auto-discharge function when it is disabled. The series are available with fixed output voltages between 1.2V to 3.3V. The TPS730xx is stable with 1 μ F MLCC.

The TPS730xx series are available in a SOT-23-5L package which is ideal for high density form factor portable equipment.



ORDERING INFORMATION

Device	Package
TPS730xxSF5	SOT-23-5L

xx: Output Voltage

ABSOLUTE MAXIMUM RATINGS (Note 1)

CHARACTERISTIC	SYMBOL	MIN	MAX	UNIT
Input Supply Voltage (Survival)	V_{IN}	-0.3	6.0	V
Enable Input Voltage (Survival)	V_{EN}	-0.3	$V_{IN} + 0.3$	V
Output Voltage (Survival)	V_{OUT}	-0.3	$V_{IN} + 0.3$	V
Maximum Output Current	I_{MAX}	-	300	mA
ESD Rating, HBM		2	-	kV
Operating Junction Temperature Range	T_{JOPR}	-40	125	°C
Storage Temperature Range	T_{STG}	-65	150	°C
Package Thermal Resistance*	$\Theta_{JA-SOT-23-5}$	265		°C/W
	$\Theta_{JC-SOT-23-5}$	130		°C/W

* Calculated from package in still air, mounted to minimum foot print 2 layer PCB without thermal via per JESD51 standards.

RECOMMENDED OPERATING RATINGS (Note 2)

CHARACTERISTIC	SYMBOL	MIN	MAX	UNIT
Input Supply Voltage	V_{IN}	2.2	5.5	V
Enable Input Voltage	V_{EN}	0	V_{IN}	V

ORDERING INFORMATION

V _{OUT}	Package	Order No.	Description	Supplied As	Status
1.2V	SOT-23-5L	TPS73012SF5	300mA, Enable	Tape & Reel	Active
1.5V	SOT-23-5L	TPS73015SF5	300mA, Enable	Tape & Reel	Active
1.8V	SOT-23-5L	TPS73018SF5	300mA, Enable	Tape & Reel	Active
2.5V	SOT-23-5L	TPS73025SF5	300mA, Enable	Tape & Reel	Contact Us
2.8V	SOT-23-5L	TPS73028SF5	300mA, Enable	Tape & Reel	Active
3.0V	SOT-23-5L	TPS73030SF5	300mA, Enable	Tape & Reel	Active
3.3V	SOT-23-5L	TPS73033SF5	300mA, Enable	Tape & Reel	Active

PIN CONFIGURATION

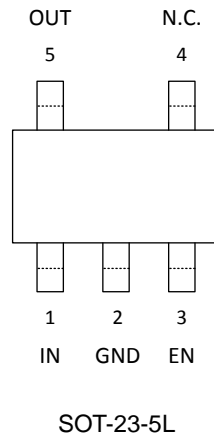

PIN DESCRIPTION

Pin No.	Pin Name	Pin Function
1	IN	Input Supply.
2	GND	Ground.
3	EN	Chip Enable. Do Not Float.
4	N.C.	No Connection.
5	OUT	Output Voltage.

BLOCK DIAGRAM

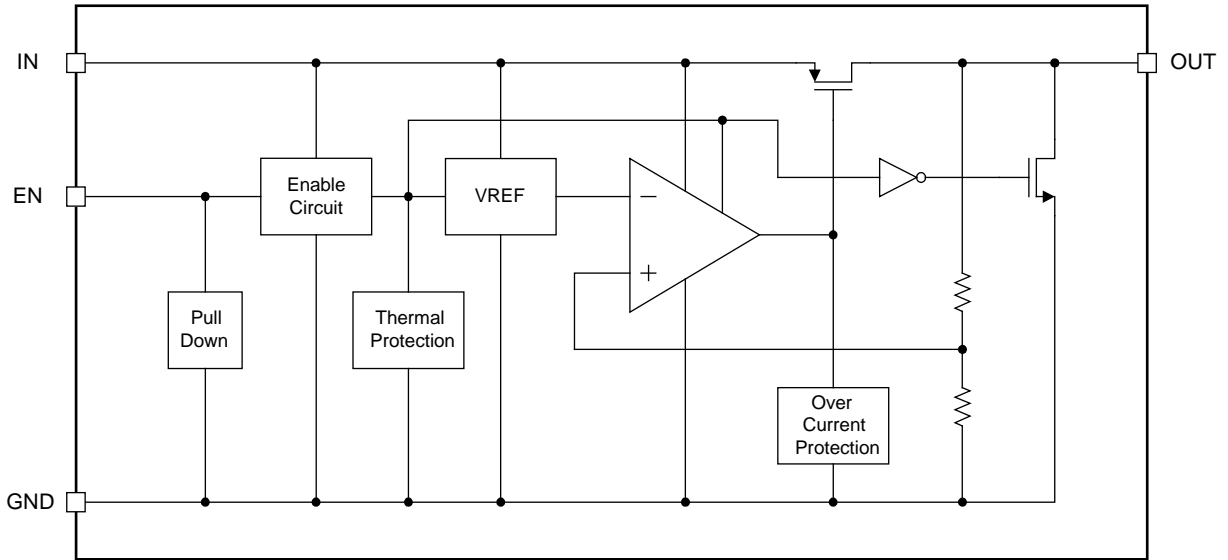

TYPICAL APPLICATION CIRCUIT

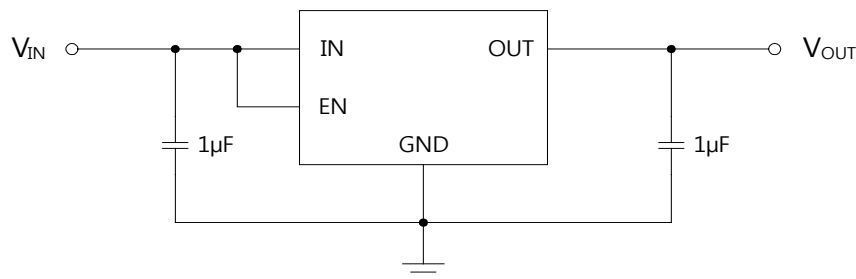
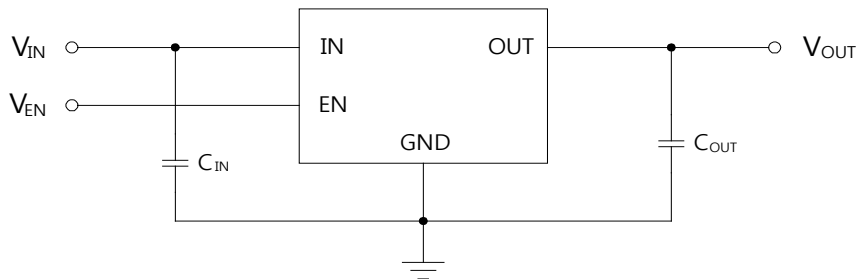
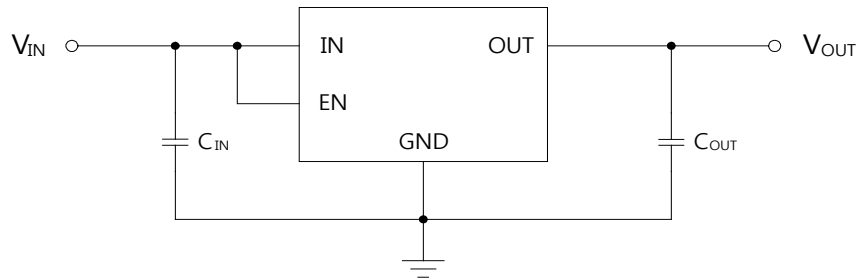

* See Application Information for the details over external capacitor.

** TPS730xx can deliver a continuous current of 300 mA over the full operating temperature. However, the output current is limited by the restriction of power dissipation which differs from packages. A heat sink may be required depending on the maximum power dissipation and maximum ambient temperature of application. With respect to the applied package, the maximum output current of 300 mA may be still undeliverable.

*** For the details, see Application Information.

ELECTRICAL CHARACTERISTICS

Limits in standard typeface are for $T_J = 25^\circ\text{C}$, and limits in **boldface type** apply over the **full operating temperature range**.

$V_{IN} = V_{O(NOM)} + 1.0\text{ V}$ or $V_{IN} = 2.2\text{ V}$, whichever is greater; $V_{EN} = V_{IN}$, $I_L = 1\text{ mA}$, $C_{IN} = C_{OUT} = 1.0\text{ }\mu\text{F}$, unless otherwise specified.

PARAMETER	SYMBOL	TEST CONDITIONS	MIN	TYP	MAX	UNIT	
Input Voltage Range ^(Note3)	V_{IN}		2.2	-	5.5	V	
Output Voltage Tolerance	V_{OUT}	$V_{OUT} + 1.0\text{ V} \leq V_{IN} \leq 5.0\text{ V}$	-2	-	2	%	
Output Current	I_{OUT}		300	-	-	mA	
Line Regulation ^(Note 4)	$\frac{\Delta V_{OUT}}{\Delta V_{IN}}$	$V_{OUT} + 1.0\text{ V} \leq V_{IN} \leq 5.0\text{ V}$	-	0.2	-	%/V	
Load Regulation ^(Note 5)	ΔV_{OUT}	$1.0\text{ mA} \leq I_{OUT} \leq 300\text{ mA}$	-	15	30	mV	
Dropout Voltage ^(Note 6)	V_{DROP}	$I_{OUT} = 200\text{ mA}$	TPS73012/15/18	-	150	220	mV
			TPS73025/28	-	135	200	mV
			TPS73030/33	-	130	195	mV
		$I_{OUT} = 300\text{ mA}$	TPS73012/15/18	-	220	330	mV
			TPS73025/28	-	200	300	mV
			TPS73030/33	-	190	290	mV
Quiescent Current ^(Note 7)	I_Q	$I_{OUT} = 0\text{ mA}$	-	35	60	μA	
Shutdown Current ^(Note 8)	I_{SD}	$V_{EN} < 0.2\text{ V}$	-	0.1	1.0	μA	
Power Supply Ripple Rejection	PSRR	$V_{IN} = V_{OUT} + 1.0\text{ V}$ or 3.0 V ^(Note 9) $f = 1.0\text{ kHz}$, $I_{OUT} = 30\text{ mA}$	-	55	-	dB	
EN Pin Input Current	I_{EN}	$V_{EN} = V_{IN}$	-	0.3	-	μA	
Enable Threshold	Logic Low	V_{ENL}	Output = Low	-	-	0.4	V
	Logic High	V_{ENH}	Output = High	1.2	-	V_{IN}	V
Thermal Shutdown Temperature	T_{SD}		-	165	-	$^\circ\text{C}$	
Thermal Shutdown Hysteresis	ΔT_{SD}		-	20	-	$^\circ\text{C}$	

Note 1. Exceeding the absolute maximum ratings may damage the device.

Note 2. The device is not guaranteed to function outside its operating ratings.

Note 3. The minimum operating value for input voltage is equal to either $(V_{OUT,NOM} + V_{DROP})$ or 2.2 V , whichever is greater.

Note 4. Output voltage line regulation is defined as the change in output voltage from the nominal value due to change in the input line voltage. Output voltage load regulation is defined as the change in output voltage from the nominal value due to change in load current.

Note 5. Regulation is measured at constant junction temperature by using a 10ms current pulse. Devices are tested for load regulation in the load range from 1.0 mA to 300 mA .

Note 6. Dropout voltage is defined as the minimum input to output differential voltage at which the output drops 2% below the nominal value. Dropout voltage specification applies only to output voltages of 2.2 V and above. For output voltages below 2.2 V, the dropout voltage is nothing but the input to output differential, since the minimum input voltage is 2.2 V.

Note 7. Ground current, or quiescent current, is the difference between input and output currents. It's defined by $I_Q = I_{IN} - I_{OUT}$ under the given loading condition. The total current drawn from the supply is the sum of the load current plus the ground pin current.

Note 8. Shutdown current, or standby current, is the input current drawn by a regulator when the output voltage is disabled by an enable signal.

Note 9. $V_{IN} = V_{OUT} + 1.0 \text{ V}$ or 3.0 V, whichever is greater.

TYPICAL OPERATING CHARACTERISTICS

VOUT = 2.8V (TPS73028)

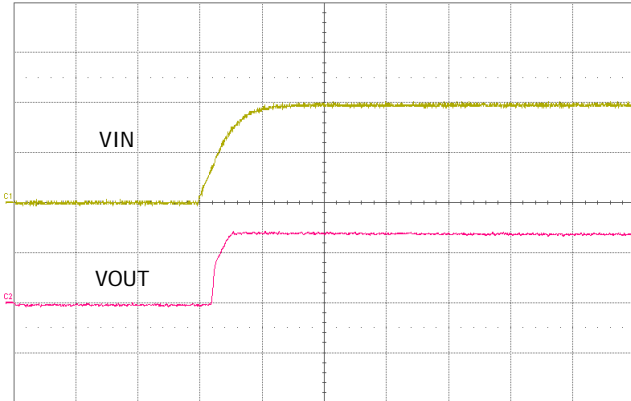

VIN : 2.0V/div, VOUT : 2.0V/div, Time : 500us/div
Vin=3.8V, Vout=2.8V

Start Up @ Iout=1mA

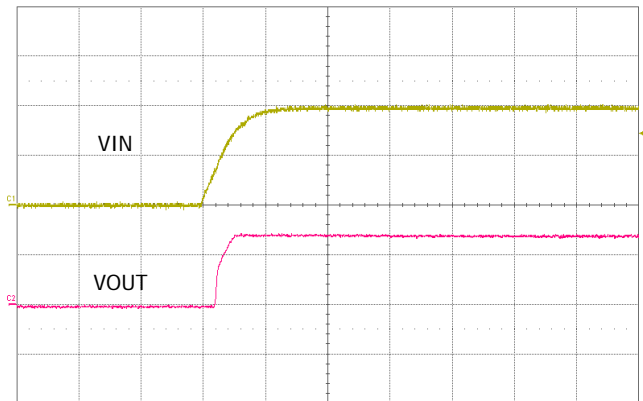

VIN : 2.0V/div, VOUT : 2.0V/div, Time : 500us/div
Vin=3.8V, Vout=2.8V

Start Up @ Iout=300mA

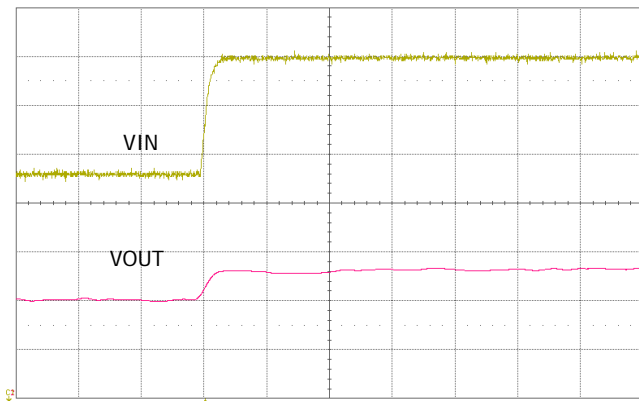

VIN : 0.5V/div, VOUT : 20mV/div, Time : 2ms/div
Vin:3.8 to 5.0V, Vout=2.8V @ Iout=1mA

Line Transient response

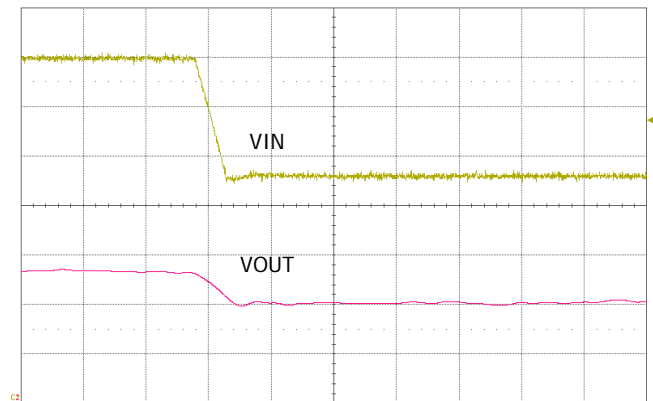

VIN : 0.5V/div, VOUT : 20mV/div, Time : 2ms/div
Vin:5.0 to 3.8V, Vout=2.8V @ Iout=1mA

Line Transient response

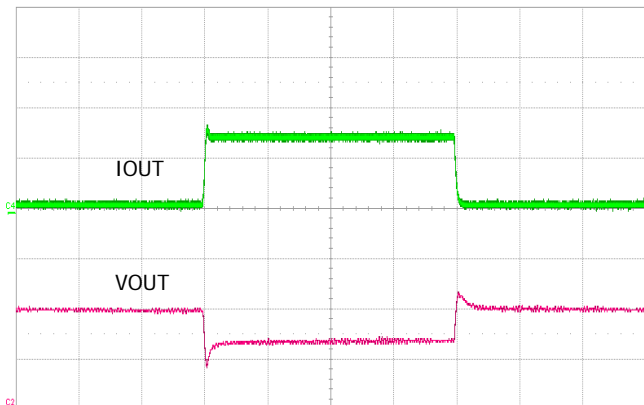

IOUT : 200mA/div, VOUT : 20mV/div, Time : 500us/div
Vin=3.8V, Vout=2.8V @ Iout=1mA to 0.3A

Load Transient response

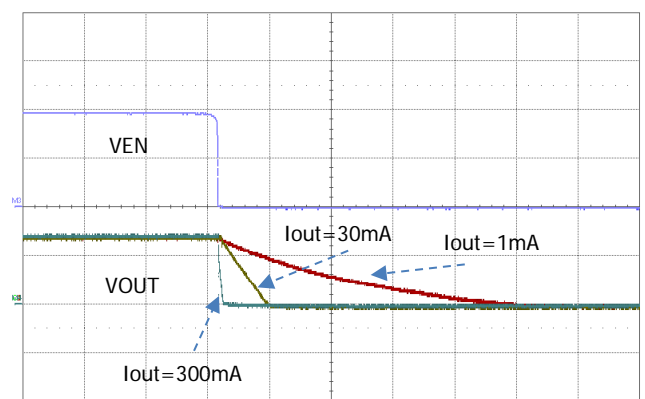

VIN : 2.0V/div, VOUT : 2.0V/div, Time : 200us/div

EN off (D version only)

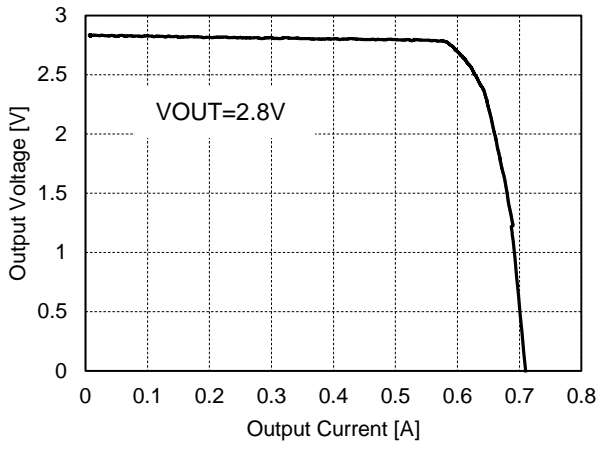

Output Voltage vs Output Current

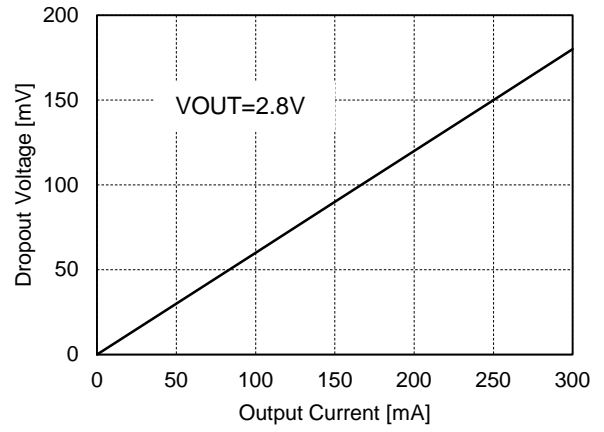

Dropout Voltage

APPLICATION INFORMATION

The TPS730xx is a high performance low dropout linear regulator designed for mobile and portable application that requires low noise with fast transient response. The TPS730xx is fully protected from damage due to fault conditions, offering constant current limiting and thermal shutdown.

INPUT SUPPLY VOLTAGE

The TPS730xx internal circuitry is supplied by the IN pin which requires low quiescent current at the no output current level. A decoupling capacitor on the IN pin is mandatory to improve the performance of the TPS730xx during line and load transient. The input voltage must be its dropout voltage above the output voltage.

ENABLE

The TPS730xx feature an active high Enable input (EN) that allows on/off control of the regulator. The enable function of TPS730xx has hysteresis characteristics. The enable input allows on control of the regulator with the enable pin voltage of 1.1V or above. When the enable input voltage lowers under 0.5V, the enable input allows off control of the regulator. If not in used for logic control, EN pin must be tied to IN pin for proper operation.

INPUT CAPACITOR

An input capacitor of minimum 1.0 μ F of MLCC is recommended. Larger values will help to improve ripple rejection by bypassing the input to the regulator, further improving the integrity of the output voltage. X7R or X5R dielectrics are recommended and it should be placed as close as to the IN pin as possible.

OUTPUT CAPACITOR

The TPS730xx requires a minimum output capacitance to maintain stability. The TPS730xx is designed to be stable with a MLCC with very low equivalent series resistance (ESR). A 1.0 μ F of MLCC would satisfy most applications. Larger values and lower ESR improves dynamic performance. X7R or X5R dielectrics are recommended to maintain sufficient capacitance over its full operating temperature. It should be placed as close as OUT pin as possible.

CURRENT LIMIT OPERATION

The TPS730xx includes constant current limit function and it helps protect the regulator during fault conditions. It does not limit current up to its capability in normal operation. For reliable operation, the regulator should not be operated in exceeding of its guaranteed output current.

AUTO DISCHARGE FUNCTION

The TPS730xx provides an auto discharge function that is used for faster discharging of the output capacitor. This function is automatically activated when the EN input goes into an active low state.

MAXIMUM OUPUT CURRENT CAPABILITY

The TPS730xx can deliver a continuous current of 300mA over the full operating junction temperature range. However, the output current is limited by the restriction of power dissipation of package. With respect to the applied package, the maximum output current of 300mA may be still undeliverable due to the restriction of the power dissipation of TPS730xx. Under all possible conditions, the junction temperature must be within the range specified under operating conditions.

The temperatures over the device are given by:

$$T_C = T_A + P_D \times \theta_{CA}$$

$$T_J = T_C + P_D \times \theta_{JC}$$

$$T_J = T_A + P_D \times \theta_{JA}$$

where T_J is the junction temperature, T_C is the case temperature, T_A is the ambient temperature, P_D is the total power dissipation of the device, θ_{CA} is the thermal resistance of case-to-ambient, θ_{JC} is the thermal resistance of junction-to-case, and θ_{JA} is the thermal resistance of junction to ambient.

The total power dissipation of the device is given by:

$$\begin{aligned} P_D &= P_{IN} - P_{OUT} = (V_{IN} \times I_{IN}) - (V_{OUT} \times I_{OUT}) \\ &= (V_{IN} \times (I_{OUT} + I_{GND})) - (V_{OUT} \times I_{OUT}) = (V_{IN} - V_{OUT}) \times I_{OUT} + V_{IN} \times I_{GND} \end{aligned}$$

where I_{GND} is the operating ground current of the device which is specified at the Electrical Characteristics. The maximum allowable temperature rise (T_{Rmax}) depends on the maximum ambient temperature (T_{Amax}) of the application, and the maximum allowable junction temperature (T_{Jmax}):

$$T_{Rmax} = T_{Jmax} - T_{Amax}$$

The maximum allowable value for junction-to-ambient thermal resistance, θ_{JA} , can be calculated using the formula:

$$\theta_{JA} = T_{Rmax} / P_D$$

If proper cooling solution such as copper plane area or air flow is applied, the maximum allowable power dissipation could be increased. However, if the ambient temperature is increased, the allowable power dissipation would be decreased.

REVISION NOTICE

The description in this datasheet is subject to change without any notice to describe its electrical characteristics properly.