

## ▶ Product Introduction

### Token (TPSRH) shielded large current inductor family series expand power applications.

#### Features :

- Magnetically shielded construction.
- Excellent solderability and high heat resistance.
- Various high power inductors are superior to be high Saturation for surface mounting.

#### Applications :

- Power supply for VCRS; OA equipment Digital camera, LCD television set notebook PC, portable communication Equipments, DC/DC converters, etc.

TPSRH63 and TPSRH65 are directly connected electrode on ferrite core with excellent property and high saturation for surface mounting.

Token enhances chip power inductor (TPSRH) family series covering complete footprint with profile from 3.0 mm to 10.8 mm, inductance from 1.00  $\mu\text{H}$  to 1000.00  $\mu\text{H}$ , low DCR 0.008 $\Omega$  to 21.6 $\Omega$ , and Rated Current up to 10.0A.

Token (TPSRH) with wire wound and magnetically shielded construction offers a variety of characteristics and high performance. Customers can select the optimum characteristics by choosing from footprint, DCR, and a wide range of inductance values and tolerances with some types offering magnetic shielding.

The series is lead-free and RoHS compliant. Application of specific designs also available including different inductance and frequency specifications adjusted to requirements. Please contact our sales or link to Token official website "[SMD Power Inductors](http://www.token.com.tw)" for more information.



**► Configurations & Dimensions**

**Dimensions & Configurations (Unit: mm) (TPSRH-124/125/127)**

Type	A ± 0.5	B ± 0.5	C (Max)	D (Red)	E (Red)	F (Red)	FIG
TPSRH63	6.2	6.6	3.0	1.5	6.6	5.9	1
TPSRH65	6.2	6.6	5.0	1.5	6.6	5.9	1
TPSRH73	7.3	7.3	3.5	1.8	7.2	5.4	2
TPSRH74	7.3	7.3	4.5	1.8	7.2	5.4	2
TPSRH105	10.0	10.0	5.0	3	9.6	7.6	3
TPSRH124	12.0	12.0	4.5	5	11.8	7.6	3
TPSRH125	12.0	12.0	6.0	5	11.8	7.6	3
TPSRH127	12.0	12.0	8.0	5	12	7.6	3
TPSRH129 *	12.0	12.0	10.0	5	12	7.6	3
TPSRH1510 *	15.0	15.0	10.8	5	15	7.6	3

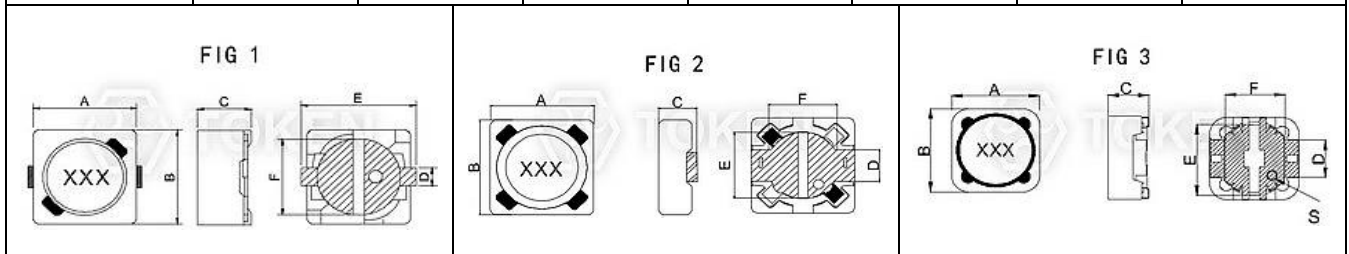

● \* Custom parts are available on request.

▶ **TPSRH63/65/73/74/105**

**Electrical Characteristics (TPSRH63/65/73/74/105)**

Inductance (μH)		TPSRH63		TPSRH65		TPSRH73		TPSRH74		TPSRH105	
Marking	L (μH)	DCR (Ω) Max.	IDC (A)	DCR (Ω) Max.	IDC (A)	DCR (Ω) Max.	IDC (A)	DCR (Ω) Max.	IDC (A)	DCR (Ω) Max.	IDC (A)
2R2	2.9	0.057	1.94								
4R0	4.0	0.070	1.63								
5R5	5.5	0.085	1.40								
100	10	0.150	1.10	0.074	1.35	0.081	2.24	0.070	1.84	0.050	2.40
120	12	0.176	1.00	0.094	1.22	0.114	1.89	0.078	1.71	0.054	2.25
150	15	0.212	0.90	0.109	1.11	0.137	1.75	0.093	1.47	0.071	2.0
180	18	0.270	0.80	0.143	1.02	0.155	1.54	0.122	1.31	0.081	1.8
220	22	0.290	0.74	0.170	0.91	0.190	1.47	0.140	1.23	0.094	1.65
270	27	0.360	0.66	0.208	0.82	0.210	1.40	0.183	1.12	0.110	1.45
330	33	0.420	0.59	0.270	0.74	0.240	1.23	0.207	0.96	0.134	1.35
390	39	0.510	0.54	0.300	0.69	0.320	1.08	0.25	0.91	0.148	1.2
470	47	0.570	0.50	0.350	0.62	0.400	1.0	0.30	0.88	0.199	1.1
560	56	0.720	0.46	0.43	0.58	0.49	0.91	0.36	0.75	0.233	1.0
680	68	0.92	0.42	0.53	0.56	0.560	0.84	0.44	0.69	0.31	0.93
820	82	1.010	0.38	0.58	0.46	0.69	0.74	0.48	0.61	0.36	0.84
101	100	1.25	0.34	0.74	0.42	0.79	0.70	0.56	0.60	0.39	0.76
121	120	1.40	0.31	0.81	0.38	0.98	0.63	0.70	0.52	0.47	0.70
151	150	1.77	0.28	0.91	0.35	1.11	0.58	0.79	0.46	0.53	0.63
181	180	2.04	0.26	1.14	0.32	1.45	0.52	0.96	0.42	0.68	0.57
221	220	2.80	0.23	1.27	0.29	1.82	0.48	1.22	0.36	0.82	0.52
271	270	3.21	0.22	1.65	0.26	2.19	0.42	1.51	0.34	0.92	0.47
331	330	4.15	0.19	2.17	0.23	2.62	0.39	1.72	0.32	1.13	0.43
391	390			2.47	0.22	3.33	0.35	2.11	0.29	1.39	0.39
471	470			2.93	0.20	3.86	0.32	2.43	0.26	1.66	0.36
561	560			3.47	0.18	4.30	0.29	3.16	0.23		
681	680			4.36	0.17	5.73	0.19	3.54	0.22		
821	820			4.77	0.15	6.54	0.18	4.49	0.2		
102	1000			6.42	0.14	8.25	0.16	5.80	0.18		

**Note:**

- Measuring Frequency. L: <100μH (100KHz/0.25v) L: >100μH Above(1KHz/0.25v) .
- IDC: The current when the inductance becomes 35% lower than its nominal value. and temperature rise 40°C Δt=40°C (ta=20°C).

▶ **TPSRH124/125/127**

**Electrical Characteristics (TPSRH124/125/127)**

Inductance (μH)		TPSRH124		TPSRH125		TPSRH127	
Marking	L (μH)	DCR (Ω) Max.	IDC (A)	DCR (Ω) Max.	IDC (A)	DCR (Ω) Max.	IDC (A)
1R2	1.2					0.007	9.8
1R3	1.3			0.008	8.0		
2R2	2.1			0.009	7.0		
3R3	3.1			0.010	6.0		
3R5	3.5					0.014	7.5
3R9	3.9	0.015	6.50	0.012	5.5		
4R7	4.7	0.018	5.70	0.014	5.0	0.016	6.8
5R8	5.8			0.018	4.4		
6R1	6.1			0.020	4.4	0.018	6.6
6R8	6.8	0.023	4.90				
7R5	7.5			0.024	4.2		
7R6	7.6					0.020	5.9
100	10	0.028	4.50	0.022	4	0.022	4.9
150	15	0.050	3.20	0.32	3.3	0.026	4.5
180	18	0.057	3.10	0.045	3.0	0.039	3.9
220	22	0.066	2.90	0.052	2.8	0.043	3.6
270	27	0.080	2.80	0.059	2.3	0.046	3.4
330	33	0.097	2.7	0.067	2.1	0.065	3.0
390	39	0.132	2.10	0.090	2.0	0.073	2.75
470	47	0.160	1.90	0.098	1.8	0.100	2.5
560	56	0.190	1.80	0.110	1.7	0.110	2.35
680	68	0.22	1.5	0.126	1.5	0.140	2.1
820	82	0.26	1.3	0.160	1.4	0.160	1.95
101	100	0.308	1.20	0.183	1.3	0.220	1.7
121	120	0.330	1.10	0.200	1.1	0.250	1.6
151	150	0.530	0.95	0.240	1.0	0.280	1.42
181	180	0.620	0.85	0.300	0.9	0.350	1.3
221	220	0.700	0.80	0.350	0.8	0.390	1.16
271	270	0.870	0.60	0.430	0.75	0.560	1.06
331	330	0.900	0.50	0.490	0.68	0.640	0.95
391	390			0.580	0.65	0.700	0.88
471	470			0.770	0.58	0.980	0.79
561	560			1.010	0.54	1.07	0.73
681	680			1.200	0.48	1.46	0.67
821	820			1.340	0.43	1.64	
102	1000			1.530	0.40	1.82	0.55

Note:

- Measuring Frequency. L: <100μH (100KHz/0.25v) L: >100μH Above(1KHz/0.25v) .
- IDC: The current when the inductance becomes 35% lower than its nominal value. and temperature rise 40°C Δt=40°C (ta=20°C).



▶ Order Codes

Order Codes (TPSRH)

TPSRH63	-	2R2		N	
Part Number		Inductance		Tolerance	
TPSRH63		2R2	2.20μH	K	±10%
TPSRH65		120	12.00μH	L	±15%
TPSRH73		121	120.00μH	M	±20%
TPSRH74		102	1000.00μH	P	±25%
TPSRH105				N	±30%
TPSRH124					
TPSRH125					
TPSRH127					

## ▶ Product Introduction

**Token (TPSRH) shielded large current inductor family series is a strong choice for Power saving.**

### Features :

- Magnetically shielded construction.
- Excellent solderability and high heat resistance.
- Various high power inductors are superior to be high Saturation for surface mounting.

### Applications :

- Power supply for VCRS; OA equipment Digital camera, LCD television set notebook PC, portable communication Equipments, DC/DC converters, etc.

Token four pin terminals flexible design Surface Mount Wirewound Inductor constructs with four terminal pin type which gives a flexible design as inductors or transformers (SEPIC, ZETA circuit, etc). Provide wide inductance range from 2.5 $\mu$ H to 1000.0 $\mu$ H in parallel connection, low direct current resistance (DCR) down to 0.018 $\Omega$ , and large current up to 14.9A. These devices are directly connected electrode on ferrite core with excellent property and high saturation for surface mounting.



Token enhances surface mount inductor (TPSRH) family series covering complete footprint with profile from 4.8 mm to 8.5 mm, inductance from 1.00  $\mu$ H to 1000.00  $\mu$ H, low DCR, and Rated Current up to 10.0A.

Token (TPSRH74B/125B/127B) with wire wound and magnetically shielded construction offers a variety of characteristics and high performance. Customers can select the optimum characteristics by choosing from footprint, DCR, and a wide range of inductance values and tolerances with some types offering magnetic shielding.

The series is lead-free and RoHS compliant. Application of specific designs also available including different inductance and frequency specifications adjusted to requirements. Please contact our sales or link to Token official website "[SMD Power Inductors](http://www.token.com.tw)" for more information.



## ► Dimensions

### Dimensions & Configurations (Unit: mm) (TPSRH-74B/125B/127B)

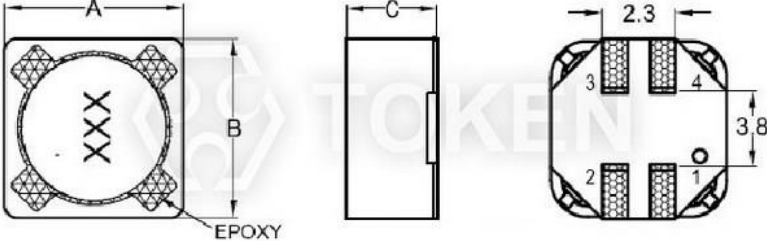
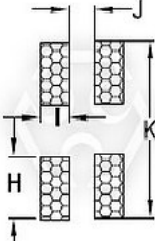
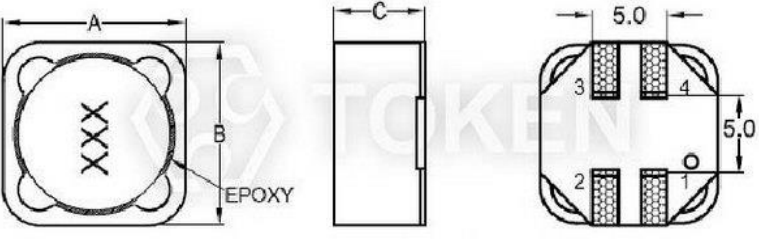
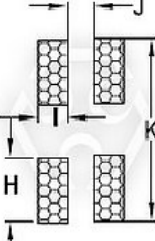
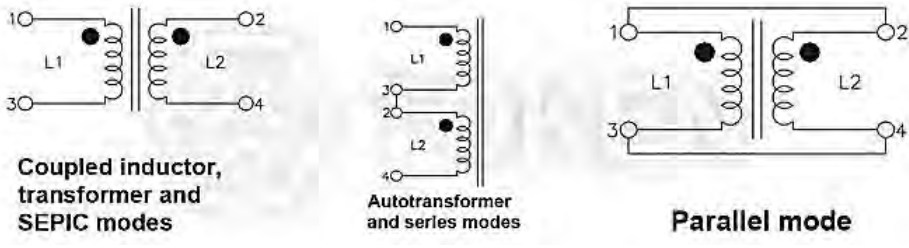
Type	A Max.	B Max.	C Max.	I	J	H	K
TPSRH74B	7.3±0.3	7.3±0.3	4.8	1.1	0.8	2.1	7.5
TPSRH125B	12.0±0.3	12.0±0.3	6.5	2.0	1.5	4.0	12.5
TPSRH127B	12.0±0.3	12.0±0.3	8.5	2.0	1.5	4.0	12.5
TPSRH74B							
TPSRH125B TPSRH127B							
Electrical Schematic	 <p style="text-align: center;"> <b>Coupled inductor, transformer and SEPIC modes</b>      <b>Autotransformer and series modes</b>      <b>Parallel mode</b> </p>						

● Note: Design as Customer's Requested Specifications.

▶ **TPSRH74B**

**Winding Schematics (TPSRH74B)**

PART NO	Leads connected in parallel					Leads connected in series				
	L (μH)	DCR (OHM) Max.	Isat (A) 30%drop typ	SRF MHz	Irms (A)	L (μH)	DCR (OHM) Max.	Isat (A) 30%drop typ	SRF MHz	Irms (A)
TPSRH74B-2R5	2.5	0.018	6.30	55.0	4.33	10.0	0.072	3.15	17.60	2.17
TPSRH74B-3R3	3.3	0.022	5.40	43.0	4.09	13.2	0.088	2.70	12.90	2.05
TPSRH74B-4R7	4.7	0.026	4.60	35.0	3.48	18.8	0.102	2.30	9.80	1.74
TPSRH74B-5R6	5.6	0.032	4.20	32.0	3.14	22.4	0.126	2.10	8.48	1.57
TPSRH74B-6R8	6.8	0.035	3.90	30.0	2.97	27.2	0.140	1.95	7.92	1.49
TPSRH74B-8R2	8.2	0.043	3.50	27.0	2.87	32.8	0.172	1.75	7.10	1.44
TPSRH74B-100	10	0.050	3.00	22.0	2.49	40	0.20	1.50	5.75	1.24
TPSRH74B-120	12	0.060	2.70	20.0	2.28	48	0.24	1.35	5.18	1.14
TPSRH74B-150	15	0.070	2.40	18.0	2.18	60	0.28	1.20	4.59	1.09
TPSRH74B-180	18	0.085	2.30	15.0	1.91	72	0.34	1.15	3.80	0.95
TPSRH74B-220	22	0.110	2.10	13.5	1.68	88	0.44	1.05	3.38	0.84
TPSRH74B-270	27	0.125	1.90	12.0	1.57	108	0.50	0.95	2.98	0.79
TPSRH74B-330	33	0.150	1.70	11.0	1.51	132	0.60	0.85	2.68	0.76
TPSRH74B-390	39	0.190	1.50	10.0	1.27	156	0.76	0.75	2.40	0.64
TPSRH74B-470	47	0.21	1.40	9.50	1.22	188	0.84	0.70	2.23	0.61
TPSRH74B-560	56	0.27	1.30	8.70	1.16	224	1.08	0.65	2.16	0.58
TPSRH74B-680	68	0.32	1.20	7.30	1.02	272	1.28	0.60	1.73	0.51
TPSRH74B-820	82	0.36	1.10	6.20	0.95	328	1.44	0.55	1.35	0.49
TPSRH74B-101	100	0.45	0.98	5.50	0.89	400	1.80	0.49	1.18	0.45
TPSRH74B-121	120	0.56	0.90	4.50	0.78	480	2.24	0.45	1.10	0.39
TPSRH74B-151	150	0.675	0.80	4.00	0.68	600	2.70	0.40	0.82	0.34
TPSRH74B-181	180	0.83	0.73	3.80	0.61	720	3.32	0.36	0.72	0.32
TPSRH74B-221	220	1.10	0.66	3.50	0.59	880	4.40	0.33	0.63	0.30
TPSRH74B-271	270	1.30	0.60	3.30	0.51	1080	5.20	0.30	0.58	0.25
TPSRH74B-331	330	1.60	0.54	3.00	0.48	1320	6.40	0.27	0.53	0.24
TPSRH74B-391	390	2.10	0.50	2.80	0.45	1560	8.40	0.25	0.48	0.23
TPSRH74B-471	470	2.35	0.46	2.60	0.40	1880	9.40	0.23	0.42	0.20
TPSRH74B-561	560	2.65	0.42	2.50	0.37	2240	10.6	0.21	0.39	0.19
TPSRH74B-681	680	3.50	0.38	2.30	0.35	2720	14.0	0.19	0.34	0.18
TPSRH74B-821	820	3.90	0.35	2.20	0.30	3280	15.6	0.175	0.32	0.15
TPSRH74B-102	1000	5.40	0.31	2.00	0.28	4000	21.6	0.155	0.28	0.144

Remark:

- DCR is for both windings . DC current at which the inductance drops 30% (typ) from its value without current . Inductance tolerance: 4.7μH~100μH tolerance can be done “M” 120μH~1000μH tolerance can be done “K” .

Note:

- Inductance shown for coupled inductor and for two inductors connected in parallel .
- Inductance is measured at 100KHz 0.1Vrms 0Adc on an Agilent/HP 4284ALC meter or equivalent .
- DCR is for both windings when connected in parallel.DCR for each winding is twice the Value .
- SRF measured using Agilent/HP E4991A or equivalent .
- Current that causes a 40°C temperature rise from 25°C ambient .





▶ **TPSRH125B**

**Winding Schematics (TPSRH125B)**

PART NO	Leads connected in parallel					Leads connected in series				
	L (μH)	DCR (OHM) Max.	Isat (A) 30%drop typ	SRF MHz	Irms (A)	L (μH)	DCR (OHM) Max.	Isat (A) 30%drop typ	SRF MHz	Irms (A)
TPSRH125B-4R7	4.7	0.018	10.30	32.0	7.2	18.8	0.072	5.15	12.00	3.4
TPSRH125B-5R6	5.6	0.020	9.66	31.0	7.0	22.4	0.080	4.83	10.30	3.3
TPSRH125B-6R8	6.8	0.024	9.21	28.0	6.6	27.2	0.095	4.61	8.40	3.2
TPSRH125B-8R2	8.2	0.026	8.55	25.0	6.4	32.8	0.104	4.28	7.10	3.1
TPSRH125B-100	10	0.030	7.40	22.0	5.40	40.0	0.120	3.70	6.00	2.8
TPSRH125B-120	12	0.037	6.86	21.0	5.2	48.0	0.147	3.43	5.80	2.7
TPSRH125B-150	15	0.042	6.09	17.6	4.6	60	0.170	3.05	5.50	2.5
TPSRH125B-180	18	0.048	5.30	17.0	4.4	72	0.194	2.65	5.00	2.2
TPSRH125B-220	22	0.058	5.01	15.0	4.2	88	0.232	2.51	4.10	2.1
TPSRH125B-270	27	0.062	4.66	13.6	3.7	108	0.248	2.33	3.50	1.9
TPSRH125B-330	33	0.067	4.22	12.7	3.6	132	0.268	2.11	3.10	1.6
TPSRH125B-390	39	0.071	3.80	11.7	3.2	156	0.284	1.90	2.80	1.5
TPSRH125B-470	47	0.087	3.25	8.7	2.9	188	0.348	1.63	2.00	1.4
TPSRH125B-560	56	0.099	3.07	7.6	2.7	224	0.396	1.54	2.00	1.3
TPSRH125B-680	68	0.108	2.83	6.1	2.5	272	0.432	1.42	1.80	1.2
TPSRH125B-820	82	0.137	2.55	5.3	2.3	328	0.548	1.28	1.60	1.1
TPSRH125B-101	100	0.161	2.20	5.0	1.9	400	0.642	1.10	1.40	1.0
TPSRH125B-121	120	0.209	2.05	4.4	1.8	480	0.834	1.03	1.20	0.8
TPSRH125B-151	150	0.238	1.82	4.0	1.7	600	0.952	0.91	1.10	0.78
TPSRH125B-181	180	0.268	1.60	3.6	1.6	720	1.072	0.80	0.81	0.75
TPSRH125B-221	220	0.346	1.51	3.2	1.5	880	1.382	0.76	0.74	0.71
TPSRH125B-271	270	0.403	1.41	2.8	1.4	1080	1.61	0.71	0.63	0.65
TPSRH125B-331	330	0.545	1.28	2.5	1.2	1320	2.18	0.64	0.60	0.56
TPSRH125B-391	390	0.600	1.16	2.3	1.0	1560	2.40	0.58	0.52	0.50
TPSRH125B-471	470	0.795	1.00	2.1	0.86	1880	3.18	0.50	0.43	0.41
TPSRH125B-561	560	0.905	0.95	2.0	0.80	2240	3.62	0.48	0.36	0.38
TPSRH125B-681	680	1.030	0.88	1.8	0.74	2720	4.12	0.44	0.32	0.35
TPSRH125B-821	820	1.325	0.79	1.5	0.67	3280	5.30	0.40	0.27	0.32
TPSRH125B-102	1000	1.530	0.69	1.20	0.50	4000	6.12	0.35	0.23	0.29

**Remark:**

- DCR is for both windings . DC current at which the inductance drops 30% (typ) from its value without current . Inductance tolerance: 4.7μH~100μH tolerance can be done “M” 120μH~1000μH tolerance can be done “K” .

**Note:**

- Inductance shown for coupled inductor and for two inductors connected in parallel .
- Inductance is measured at 100KHz,0.1Vrms,0Adc on an Agilent/HP 4284ALC meter or equivalent .
- DCR is for both windings when connected in parallel.DCR for each winding is twice the Value .
- SRF measured using Agilent/HP E4991A or equivalent .
- Current that causes a 40°C temperature rise from 25°C ambient .

▶ **TPSRH127B**

**Winding Schematics (TPSRH127B)**

PART NO	Leads connected in parallel					Leads connected in series				
	L (μH)	DCR (OHM) Max.	Isat (A) 30%drop typ	SRF MHz	Irms (A)	L (μH)	DCR (OHM) Max.	Isat (A) 30%drop typ	SRF MHz	Irms (A)
TPSRH127B-4R7	4.7	0.019	14.90	32.0	7.4	18.8	0.076	7.70	12.0	3.6
TPSRH127B-5R6	5.6	0.023	13.40	25.0	7.2	22.4	0.092	6.60	10.4	3.5
TPSRH127B-6R8	6.8	0.024	13.10	24.0	6.9	27.2	0.096	6.40	9.5	3.4
TPSRH127B-8R2	8.2	0.025	10.80	18.0	6.6	32.8	0.100	5.60	7.2	3.3
TPSRH127B-100	10	0.029	10.50	16.5	6.2	40.0	0.116	5.40	6.6	3.2
TPSRH127B-150	15	0.036	9.10	11.8	5.8	60	0.144	4.30	5.0	2.7
TPSRH127B-180	18	0.040	8.00	10.5	5.5	72	0.158	3.90	3.8	2.5
TPSRH127B-220	22	0.048	6.80	9.0	5.2	88	0.190	3.50	3.4	2.2
TPSRH127B-270	27	0.060	6.50	8.4	4.7	108	0.240	3.40	3.2	2.0
TPSRH127B-330	33	0.075	5.60	7.6	4.2	132	0.300	3.10	3.0	1.4
TPSRH127B-390	39	0.080	5.50	6.5	3.6	156	0.320	2.80	2.6	1.6
TPSRH127B-470	47	0.090	5.20	6.0	3.0	188	0.360	2.60	2.1	1.5
TPSRH127B-560	23	0.095	4.50	5.6	2.8	224	0.380	2.4	2.0	1.4
TPSRH127B-680	68	0.105	4.10	5.0	2.6	272	0.420	2.10	1.6	1.3
TPSRH127B-820	82	0.140	3.80	4.1	2.3	328	0.560	1.90	1.3	1.2
TPSRH127B-101	100	0.150	3.40	3.6	2.0	400	0.600	1.70	1.1	1.1
TPSRH127B-121	120	0.205	3.20	3.2	1.9	480	0.820	1.60	1.0	1.0
TPSRH127B-151	150	0.230	2.80	3.0	1.8	600	0.92	1.40	0.82	0.89
TPSRH127B-181	180	0.255	2.50	2.7	1.7	720	1.020	1.30	0.70	0.84
TPSRH127B-221	220	0.345	2.30	2.5	1.6	880	1.380	1.10	0.64	0.75
TPSRH127B-271	270	0.450	2.10	2.1	1.5	1080	1.80	1.00	0.55	0.71
TPSRH127B-331	330	0.510	1.90	2.0	1.3	1320	2.04	0.92	0.47	0.62
TPSRH127B-391	390	0.560	1.70	1.8	1.1	1560	2.24	0.84	0.41	0.53
TPSRH127B-471	470	0.765	1.60	1.6	0.87	1880	3.06	0.80	0.36	0.43
TPSRH127B-561	560	0.845	1.50	1.5	0.83	2240	3.38	0.73	0.31	0.40
TPSRH127B-681	680	1.145	1.30	1.4	0.76	2720	4.58	0.63	0.30	0.36
TPSRH127B-821	820	1.275	1.20	1.3	0.69	3280	5.10	0.58	0.24	0.33
TPSRH127B-102	1000	1.415	1.10	1.1	0.60	4000	5.66	0.56	0.20	0.30

**Remark:**

- DCR is for both windings . DC current at which the inductance drops 30% (typ) from its value without current . Inductance tolerance: 4.7μH~100μH tolerance can be done “M” 120μH~1000μH tolerance can be done “K” .

**Note:**

- Inductance shown for coupled inductor and for two inductors connected in parallel .
- Inductance is measured at 100KHz 0.1Vrms 0Adc on an Agilent/HP 4284ALC meter or equivalent .
- DCR is for both windings when connected in parallel DCR for each winding is twice the Value .
- SRF measured using Agilent/HP E4991A or equivalent .
- Current that causes a 40°C temperature rise from 25°C ambient .



▶ Order Codes

Order Codes (TPSRH-74B/125B/127B)

TPSRH74B	-	6R8		N	
Part Number		Inductance		Tolerance	
TPSRH74B		2R5	2.50μH	J	±5%
TPSRH125B		100	10.00μH	K	±10%
TPSRH127B		101	100.00μH	L	±15%
		102	1000.00μH	M	±20%
				P	±25%
				N	±30%

**► Product Introduction**

**Token (TPSRH) shielded high current inductor is superior to be high Saturation for SMT.**

**Features :**

- Magnetically shielded construction.
- Excellent solderability and high heat resistance.
- Various high power inductors are superior to be high Saturation for surface mounting.

**Applications :**

- Power supply for VCRS; OA equipment Digital camera, LCD television set notebook PC, portable communication Equipments, DC/DC converters, etc.

TPSRH103R, TPSRH104R, and TPSRH105R provide wide inductance range from 1.20 $\mu$ H to 1000.00 $\mu$ H, low direct current resistance (DCR) down to 0.008 $\Omega$ , and large current up to IDC 10.0A. These devices are directly connected electrode on ferrite core with excellent property and high saturation for surface mounting.

Token enhances SMD wirewound (TPSRH-63R/103R/104R/105R) family inductors covering complete footprint with profile from 1.8 mm to 8.0 mm, inductance from 1.00  $\mu$ H to 1000.00  $\mu$ H, low DCR, and Rated Current up to 8.5A.

Token (TPSRH-63R/103R/104R/105R) with wire wound and magnetically shielded construction offers a variety of characteristics and high performance. Customers can select the optimum characteristics by choosing from footprint, DCR, and a wide range of inductance values and tolerances with some types offering magnetic shielding.

The series is lead-free and RoHS compliant. Custom parts are available on request. Token will also produce devices outside these specifications to meet specific customer requirements.

Application of specific designs also available including different inductance and frequency specifications adjusted to requirements. Please contact our sales or link to Token official website "[SMD Power Inductors](http://www.token.com.tw)" for more information.



► **Dimensions**

**Dimensions & Configurations (Unit: mm) (TPSRH-63R/103R/104R/105R)**

Type	A±0.3	B±0.3	C (Max)	D (Red)	E (Red)	F (Red)	a (Red)	b (Red)	c (Red)	d (Red)
TPSRH63R	5.9	6.0	3.0	4.7	2.0	0.6	2.6	1.0	4.6	1.0
TPSRH103R	10	10.1	3.0	7.7	3.0	1.2	3.6	1.7	7.3	1.7
TPSRH104R	10	10.1	4.0	7.7	3.0	1.2	3.6	1.7	7.3	1.7
TPSRH105R	10	10.1	5.0	7.7	3.0	1.2	3.6	1.7	7.3	1.7

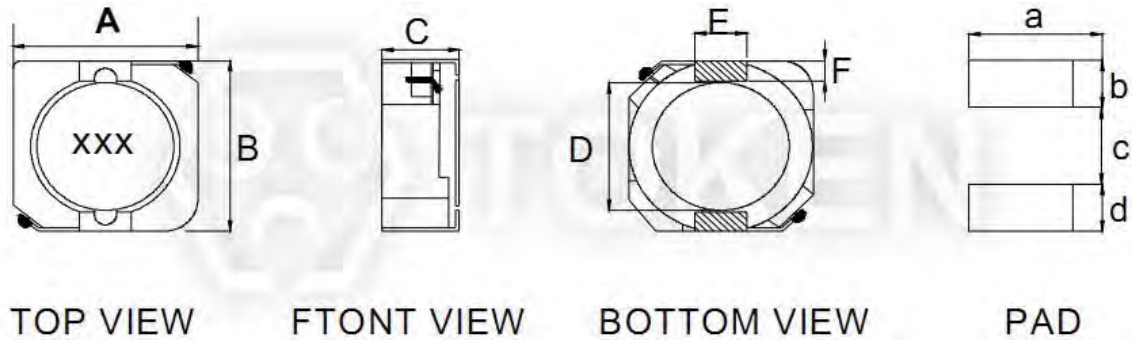

SMD Shielded High Current Inductors (TPSRH-63R/103R/104R/105R)  
Dimensions (Unit: mm)

● Note: Design as Customer's Requested Specifications.

▶ **TPSRH-63R/103R/104R/105R**

**Electrical Characteristics (TPSRH-63R/103R/104R/105R)**

Inductance (μH)		TPSRH63R		TPSRH103R		TPSRH104R		TPSRH105R	
Marking	L (μH)	DCR (Ω) Max.	IDC (A)	DCR (Ω) Max.	IDC (A)	DCR (Ω) Max.	IDC (A)	DCR (Ω) Max.	IDC (A)
1R2	1.2			0.012	4.80	0.016	5.40	0.008	8.50
1R5	1.5							0.008	8.30
2R2	2.2	0.018	2.60	0.018	4.10	0.02	4.95	0.011	7.50
3R3	3.3	0.020	2.30	0.019	3.90	0.025	4.35	0.013	6.50
3R9	3.9			0.022	3.76	0.026	4.05		
4R7	4.7	0.031	1.85	0.030	3.20	0.034	4.00	0.016	4.80
6R8	6.8			0.036	3.10	0.035	3.50	0.024	4.40
8R2	8.2	0.050	1.50	0.039	3.00			0.026	4.05
100	10	0.054	1.30	0.047	2.80	0.045	3.15	0.027	3.45
120	12	0.072	1.2	0.057	2.25	0.059	3.00	0.032	3.40
150	15	0.082	1.10	0.063	2.22	0.072	2.90	0.043	2.83
180	18	0.102	1.05	0.081	1.90	0.077	2.70	0.048	2.62
220	22	0.119	0.95	0.095	1.78	0.086	2.50	0.059	2.44
270	27	0.146	0.85	0.110	1.63	0.104	2.10	0.078	2.24
330	33	0.183	0.76	0.135	1.32	0.133	2.00	0.056	1.88
390	39	0.210	0.68	0.163	1.18	0.148	1.90	0.109	1.70
470	47	0.23	0.60	0.196	1.16	0.174	1.80	0.122	1.56
560	56	0.305	0.55	0.230	1.10	0.216	1.62	0.145	1.39
680	68	0.351	0.48	0.27	1.04	0.299	1.35	0.17	1.36
820	82	0.419	0.45	0.310	0.94	0.325	1.26	0.196	1.20
101	100	0.520	0.40	0.38	0.84	0.403	1.17	0.230	1.09
121	120			0.480	0.76	0.490	1.05	0.298	1.00
151	150			0.560	0.74	0.611	1.00	0.410	0.91
181	180			0.640	0.68	0.660	0.80	0.420	0.84
221	220			0.78	0.66	0.939	0.70	0.500	0.75
271	270			0.960	0.58	1.170	0.60	0.570	0.68
331	330			1.18	0.51	1.30	0.53	0.700	0.60
391	390			1.48	0.49	1.56	0.45	0.68	0.57
471	470			1.82	0.45	1.76	0.40	1.03	0.50
561	560							1.21	0.47
681	680							1.52	0.43
821	820							1.85	0.39
102	1000							2.05	0.35

Note:

- Measuring Frequency. L:1.0 uH ~82uH(100KHz/0.25v) 100uH Above(1KHz/0.3v).
- IDC: The current when the inductance becomes 35% lower than its nominal value. and temperature rise 40°C Δt=40°C (ta=20°C).

▶ Order Codes

Order Codes (TPSRH-63R/103R/104R/105R)

TPSRH63R	-	1R2		-	M	
Part Number		Inductance			Tolerance	
TPSRH63R		1R2	1.20μH		K	10%
TPSRH103R		100	10.00μH		K	±10%
TPSRH104R		101	100.00μH		L	±15%
TPSRH105R		102	1000.00μH		M	±20%
					P	±25%
					N	±30%

## ▶ Product Introduction

**Power high-current inductors feature wide inductance range with low DCR low profile.**

### Features :

- Magnetically shielded construction.
- Excellent solderability and high heat resistance.
- Various high power inductors are superior to be high Saturation for surface mounting.

### Applications :

- Power supply for VCRS; OA equipment Digital camera, LCD television set notebook PC, portable communication Equipments, DC/DC converters, etc.

Token has unveiled (TPSRH-2D/3D/4D/5D/6D/8D) surface mount low-profile inductor series. Those compact devices feature ultra-low 1.1 mm to maximum 6.0 mm profile, with a wide inductance range and low direct current resistance (DCR).

Token enhances power wirewound inductor (TPSRH-2D/3D/4D/5D/6D/8D) family series covering complete footprint and inductance from 1.00  $\mu$ H to 180.00  $\mu$ H, low DCR, and Rated Current up to 7.0A.

Token (TPSRH-2D/3D/4D/5D/6D/8D) with wire wound and magnetically shielded construction offers a variety of characteristics and high performance. Customers can select the optimum characteristics by choosing from footprint, DCR, and a wide range of inductance values and tolerances with some types offering magnetic shielding.

The series is lead-free and RoHS compliant. Custom parts are available on request. Token will also produce devices outside these specifications to meet specific customer requirements.

Application of specific designs also available including different inductance and frequency specifications adjusted to requirements. Please contact our sales or link to Token official website "[SMD Power Inductors](http://www.token.com.tw)" for more information.





## ► Dimensions

### Dimensions & Configurations (Unit: mm) (TPSRH-2D11~3D14)

RART NO	A±0.3	B±0.3	C±0.3	D (Ref)	E (Ref)	F (Ref)	G (Ref)
TPSRH2D11	2.9	2.9	1.1	4.2	2.1	1.0	
TPSRH2D14	2.9	1.3	4.2	2.1	1.0	1.3	
TPSRH2D16	2.9	2.9	1.8	4.2	2.1	1.0	
TPSRH2D18	2.9	2.9	1.8	4.2	2.1	1.0	
TPSRH3D14	3.7	3.7	1.6	5.2	2.8	1.1	

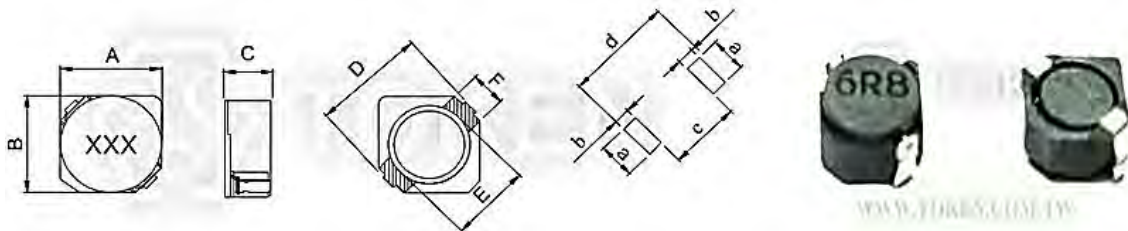

### Dimensions & Configurations (Unit: mm) (TPSRH-3D16~6D38)

RART NO	A±0.3	B±0.3	C (Max)	D (Max)	E (Red)	G (Red)	a	b	c	d
TPSRH3D16	3.9	3.9	2.0	5.6	3.5	1	1.6	1.6	1.4	4.6
TPSRH3D18	3.9	3.9	2.1	5.6	3.7	1	1.6	1.6	1.4	4.6
TPSRH3D28	3.9	3.9	3.2	5.6	3.7	1	1.6	1.6	1.4	4.6
TPSRH4D18	4.9	4.9	2.0	6.9	4.5	1.5	1.9	1.9	1.5	5.3
TPSRH4D28	4.9	4.9	3.0	6.9	4.5	1.5	1.9	1.9	1.5	5.3
TPSRH5D18	5.9	5.9	2.0	8.2	5.5	2.0	2.15	2.15	2.0	6.3
TPSRH5D28	5.9	5.9	3.0	8.2	5.5	2.0	2.15	2.15	2.0	6.3
TPSRH6D28	6.9	6.9	3.0	9.5	6.5	2.0	2.65	2.65	2.0	7.0
TPSRH6D38	6.9	6.9	4.0	9.5	6.5	2.0	2.65	2.65	2.0	7.3

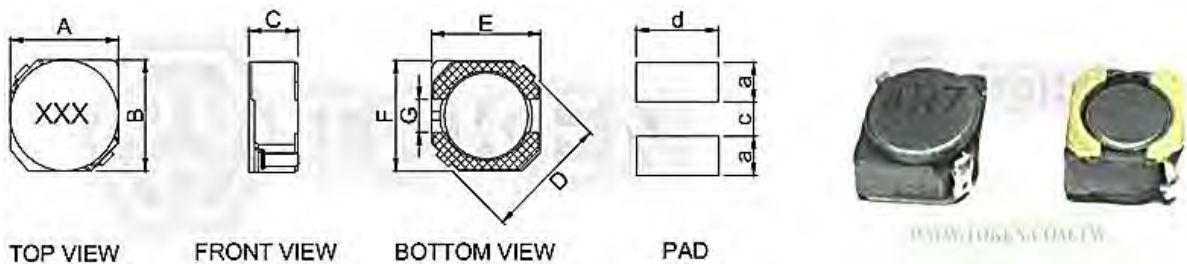

**Dimensions & Configurations (Unit: mm) (TPSRH-8D28~8D58)**

RART NO	A±0.3	B±0.3	C (Max)	D (Red)	E (Red)	F (Red)	a (Red)	b (Red)	c (Red)	d (Red)
TPSRH8D28	8	8	3.0	6.3	1.2	2.5	10.1	6.1	2.8	2.0
TPSRH8D38	8	8	4.0	6.3	1.2	2.5	10.1	6.1	2.8	2.0
TPSRH8D43	8	8	4.5	6.3	1.2	2.5	10.1	6.1	2.8	2.0
TPSRH8D58	8	8	6.0	6.3	1.2	2.5	10.1	6.1	2.8	2.0

  

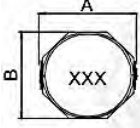

TOP VIEW

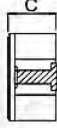

FRONT VIEW

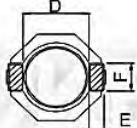

BOTTOM VIEW

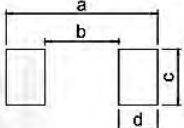

PAD



WWW.TOKEN.COM.TW

▶ **TPSRH2D/TPSRH3D**

**Electrical Characteristics (TPSRH2D/TPSRH3D)**

Inductance (μH)		TPSRH2D11		TPSRH2D14		TPSRH2D16		TPSRH2D18		TPSRH3D14	
Marking	L (μH)	DCR (Ω)Max.	IDC (A)	DCR (Ω)Max.	IDC (A)	DCR (Ω)Max.	IDC (A)	DCR (Ω)Max.	IDC (A)	DCR (Ω)Max.	IDC (A)
1R2	1.2	0.056	1.000	0.057	2.00					0.045	2.150
1R5	1.5	0.068	0.900	0.073	1.800						
1R8	1.8			0.075	1.650						
2R2	2.2	0.098	0.780	0.094	1.550	0.047	0.860	0.041	0.850	0.069	1.600
2R5	2.5	0.103	0.700								
2R7	2.7			0.117	1.350	0.061	0.820			0.088	1.450
3R3	3.3	0.130	0.630			0.067	0.720	0.054	0.750	0.100	1.350
4R7	4.7	0.177	0.500	0.222	1.000	0.101	0.620	0.078	0.630	0.150	1.100
5R6	5.6	0.187	0.500	0.240	0.950	0.123	0.570				
6R8	6.8	0.27	0.450	0.330	0.850	0.158	0.500	0.106	0.520		
8R2	8.2	0.300	0.400	0.350	0.800	0.171	0.450			0.238	0.820
100	10	0.400	0.430	0.400	0.700	0.195	0.420	0.180	0.430	0.262	0.750
120	12			0.394	0.620	0.223	0.390			0.350	0.670
150	15					0.248	0.350	0.220	0.350	0.488	0.600
180	18					0.316	0.320				
220	22					0.418	0.280	0.320	0.300	0.575	0.520
270	27					0.466	0.260				
330	33							0.460	0.240		
470	47							0.660	0.200		

Note:

- Measuring Frequency. L: 100KHz/0.25v.
- IDC: The current when the inductance becomes 35% lower than its nominal value. and temperature rise 40°C Δt = 40°C (ta = 20°C).



▶ **TPSRH3D/TPSRH4D**

**Electrical Characteristics (TPSRH3D/TPSRH4D)**

Inductance (μH)		TPSRH3D16		TPSRH3D18		TPSRH3D28		TPSRH4D18		TPSRH4D28	
Marking	L (μH)	DCR (Ω)Max.	IDC (A)	DCR (Ω)Max.	IDC (A)	DCR (Ω)Max.	IDC (A)	DCR (Ω)Max.	IDC (A)	DCR (Ω)Max.	IDC (A)
1R0	1.0	0.03	2.00	0.056	2.50					0.027	2.70
1R2	1.2							0.027	1.68	0.024	2.56
1R5	1.5	0.04	1.60	0.073	2.30			0.034	1.65	0.030	2.46
1R8	1.8	0.046	1.4	0.083	2.00					0.031	2.2
2R2	2.2	0.054	1.30	0.096	1.90			0.043	1.32	0.035	2.04
2R7	2.7	0.069	1.10	0.124	1.70			0.055	1.28	0.038	1.80
3R3	3.3	0.075	1.00	0.127	1.50	0.072	2.00	0.066	1.01	0.043	1.57
3R9	3.9	0.090	0.90	0.162	1.40			0.074	0.88	0.059	1.44
4R7	4.7	0.112	0.85	0.188	1.35	0.088	1.65	0.089	0.845	0.062	1.32
5R6	5.6	0.118	0.800	0.230	1.2			0.118	0.80	0.074	1.17
6R8	6.8	0.141	0.700	0.270	1.10	0.119	1.24	0.143	0.76	0.087	1.12
8R2	8.2	0.184	0.650					0.155	0.68	0.10	1.04
100	10	0.230	0.600	0.390	0.90	0.145	1.05	0.179	0.61	0.125	1.00
120	12	0.250	0.540	0.400	0.800			0.216	0.56	0.136	0.84
150	15	0.310	0.500	0.480	0.75	0.213	0.90	0.240	0.50	0.173	0.76
180	18	0.380	0.420	0.530	0.65			0.338	0.48	0.208	0.72
220	22	0.500	0.380	0.74	0.70	0.335	0.76	0.397	0.41	0.222	0.70
270	27	0.570	0.350	0.810	0.500			0.441	0.35	0.261	0.58
330	33	0.750	0.300	1.090	0.45	0.481	0.58	0.570	0.32	0.331	0.56
390	39			1.190	0.40			0.709	0.30	0.384	0.50
470	47			1.680	0.35	0.599	0.48	0.78	0.28	0.380	0.48
560	56							0.970	0.26	0.480	0.41
680	68							1.30	0.22	0.66	0.35
820	82							1.35	0.22	0.66	0.41
101	100							0.970	0.26	0.480	0.41
121	120							1.95	0.18	0.950	0.27
151	150							2.12	0.15	0.180	0.41
181	180							2.50	0.14	1.330	0.22

Note:

- Measuring Frequency. L: 100KHz/0.25v.
- IDC: The current when the inductance becomes 35% lower than its nominal value. and temperature rise 40°C Δt = 40°C (ta = 20°C).



▶ **TPSRH5D/TPSRH6D**

**Electrical Characteristics (TPSRH5D/TPSRH6D)**

Inductance (μH)		TPSRH5D18		TPSRH5D28		TPSRH6D28		TPSRH6D38	
Marking	L (μH)	DCR (Ω)Max.	IDC (A)	DCR (Ω)Max.	IDC (A)	DCR (Ω)Max.	IDC (A)	DCR (Ω)Max.	IDC (A)
2R7	2.7			0.033	2.60				
3R0	3.0	0.053	0.230			0.024	3.00		
3R3	3.3			0.035	2.30			0.026	3.5
3R9	3.9	0.065	2.0	0.044	2.2	0.027	2.60	0.028	3.00
4R1	4.1	0.077	1.95						
6R8	6.8	0.109	1.50					0.039	2.30
8R2	8.2			0.069	1.60				
100	10	0.139	1.20	0.091	1.30	0.065	1.70	0.053	2.00
120	12	0.195	1.10	0.098	1.20	0.070	1.55	0.060	1.70
150	15	0.220	0.97	0.115	1.10	0.084	1.40	0.073	1.60
180	18	0.270	0.85	0.138	1.00	0.095	1.32	0.086	1.50
220	22	0.350	0.80	0.160	0.90	0.128	1.20	0.099	1.30
270	27	0.380	0.75	0.203	0.85	0.142	1.05	0.117	1.2
330	33	0.480	0.65	0.238	0.75	0.165	0.97	0.146	1.10
390	39	0.60	0.57	0.270	0.70	0.210	0.86	0.187	1.00
470	47	0.70	0.54	0.330	0.62	0.238	0.80	0.217	0.95
560	56	0.84	0.50	0.400	0.58	0.277	0.73	0.230	0.85
680	68	0.95	0.43	0.510	0.50	0.304	0.65	0.270	0.75
820	82	1.24	0.41	0.570	0.46	0.390	0.60	0.330	0.70
101	100	1.34	0.36	0.69	0.42	0.535	0.54	0.420	0.65

Note:

- Measuring Frequency. L: 100KHz/0.25v.
- IDC: The current when the inductance becomes 35% lower than its nominal value. and temperature rise 40°C Δt = 40°C (ta = 20°C).



▶ **TPSRH8D**

**Electrical Characteristics (TPSRH8D)**

Inductance (μH)		TPSRH8D28		TPSRH8D38		TPSRH8D43		TPSRH8D58	
Marking	L (μH)	DCR (Ω)Max.	IDC (A)	DCR (Ω)Max.	IDC (A)	DCR (Ω)Max.	IDC (A)	DCR (Ω)Max.	IDC (A)
1R8	1.8			0.015	7.00				
2R0	2.0	0.22	5.00			0.22	7.00		
2R5	2.5	0.024	4.5	0.017	6.50				
3R3	3.3					0.027	6.00		
3R5	3.5	0.031	4.00	0.024	5.00				
3R9	3.9					0.030	4.50	0.016	4.10
4R7	4.7	0.040	3.40	0.029	4.60	0.033	4.30		
5R0	5.0							0.017	3.80
6R2	6.2	0.049	3.00			0.036	4.00	0.02	3.30
6R8	6.8					0.045	4.40		
7R3	7.3	0.060	2.80						
100	10	0.079	2.50	0.048	3.00	0.059	3.08	0.026	2.6
150	15	0.109	1.90	0.067	2.75	0.083	2.24	0.037	2.30
220	22	0.157	1.60	0.105	2.30	0.118	2.00	0.046	1.70
330	33	0.205	1.30	0.157	1.75	0.160	1.50	0.065	1.50
470	47	0.310	1.15	0.189	1.52	0.230	1.33	0.091	1.20
680	68	0.430	0.92	0.290	1.30	0.280	1.12	0.13	1.00
101	100	0.56	0.75	0.410	1.05	0.440	0.91	0.18	0.80

Note:

- Measuring Frequency. L: 100KHz/0.25v.
- IDC: The current when the inductance becomes 35% lower than its nominal value. and temperature rise 40°C Δt = 40°C (ta = 20°C).

▶ **Order Codes**

**Order Codes (TPSRH-2D/3D/4D/5D/6D/8D)**

TPSRH2D11			-	1R2		N	
Part Number				Inductance		Tolerance	
TPSRH2D11	TPSRH3D28	TPSRH8D28		1R2	1.20μH	K	±10%
TPSRH2D14	TPSRH4D18	TPSRH8D38		100	10.00μH	L	±15%
TPSRH2D16	TPSRH4D28	TPSRH8D43		470	47.00μH	M	±20%
TPSRH2D18	TPSRH5D18	TPSRH8D58		102	100.00μH	P	±25%
TPSRH3D14	TPSRH5D28	TPSRH3D18				N	±30%
TPSRH3D16	TPSRH6D28	TPSRH6D38					

## ► General Information

### How to Quickly Search Inductor for all of the Characteristics?

#### Quickly Search Inductor Finder

Searching and comparing data sheets of inductor manufacturers can be time consuming. Token's Parameter Sorting Search Mode allows selection of inductors based on different parameters.

By entering just the inductance value,

By sorting parameter to narrow down searching range,

Or by enter keyword / part number / size dimensions L\*W\*H to partial or exact searching.

### Leading-Edge Technology

Token Electronics brand passive component specializes in standard and custom solutions offering the latest in state-of-the-art low profile high power density inductor components. Token provides cost-effective, comprehensive solutions that meet the evolving needs of technology-driven markets. In working closely with the industry leaders in chipset and core development, we remain at the forefront of innovation and new technology to deliver the optimal mix of packaging, high efficiency and unbeatable reliability. Our designs utilize high frequency, low core loss materials, new and custom core shapes in combination with innovative construction and packaging to provide designers with the highest performance parts available on the market.

### Find Inductor Solutions Faster

#### Find Your Inductor - wt.moc.nekot@qfr

Only timely and accurate information can help manage the changing needs of your customers. The Token Inductor Finder puts you only a click away from all of the inductor information you need.

#### Find Your Solution - wt.moc.nekot@qfr

Selecting the correct inductor solution will not only save you time, but it will give you a competitive edge. At Token, we are committed to helping you find the most efficient alternative for your power design. Our inductor and power supply design experts can help you make that selection.

Please forward us:

- A brief description of your particular application's requirements.
- Details of an existing solution that you'd like to replace, enhance or find an alternative.
- Inquiries for feasibility to tailor a power transformer or inductor to your specific application.

We can also help you with any additional technical information you might need relating to any of our products.

**Ask Us Today**

