

Product Description

The TQ9223C 3V RFIC Downconverter is a RF receiver IC front end designed for the high dynamic range cellular communications standards. The TQ9223C provides a 2.8dB system noise figure for excellent sensitivity, and a good signal range with -11dB input IP3. Its low current consumption, single +3V operation and small plastic surface-mount package are ideally suited for cost-competitive, space-limited and portable applications. The TQ9223C will operate over a RF frequency range of 800 to 1000MHz, and therefore may be used for any of the cellular and cordless telephony standards.

Electrical Specifications¹

Parameter	Min	Typ	Max	Units
Frequency	800		1000	MHz
Gain		19.0		dB
Noise Figure		2.6		dB
Input 3 rd Order Intercept		-11.0		dBm
DC supply Current			15.0	mA

Note 1: Test Conditions: Vdd=3.75V, Ta=25C, filter IL=3.0dB, RF=881MHz, LO=966MHz, IF=85MHz, LO input=-6dBm

TQ9223C

DATA SHEET

3V Cellular TDMA/AMPS LNA/mixer Receiver IC

Features

- +3-V single supply
- On-chip LO buffer
- Mixer LO and RF matched to 50W
- Low-cost SO-14 plastic package
- Gain Select (high/low)

Applications

- Digital Mobile Phones
- AMPS Mobile Phones
- ISM 900MHz
- Cordless Telephones
- CDPD terminals

TQ9223C

Data Sheet

Electrical Characteristics

Parameter	Conditions	Min.	Typ/Nom	Max.	Units
RF Frequency	Tuned external match	800		1000	MHz
LO Frequency	Tuned external match	500		1300	MHz
IF Frequency	Tuned external match	45		300	MHz
LO input level		-7	-4	0	dBm
Supply voltage		3.0	3.75	5.5	V
Gain		17.0	19.0		dB
Noise Figure			2.6	3.5	dB
Input 3 rd Order Intercept			-11.0		dBm
Return Loss	Mixer RF input	10			dB
	Mixer LO input	10			dB
Isolation	LO to RF input		45		dB
	Mixer LO to IF after external match		40		dB
Supply Current				15	mA

Note 1: Test Conditions: V_{dd}=3.75V, T_a=25C, filter IL=3.0dB, RF=881MHz, LO=966MHz, IF=85MHz, LO input=-6dBm: unless otherwise specified.

Electrical Characteristics-LNA section only

Parameter	Conditions	Min.	Typ/Nom	Max.	Units
Gain			18.5		dB
Noise Figure			1.8		dB
Input 3 rd Order Intercept			-6.0		dBm
Reverse Isolation			28.0		dB
Supply Current			5.0		mA

Note 1: Test Conditions: V_{dd}=3.75V, T_a=25C, RF=881MHz, external input and output match; unless otherwise specified.

Electrical Characteristics- Mixer section only

Parameter	Conditions	Min.	Typ/Nom	Max.	Units
Conversion Gain			3.5		dB
Noise Figure			12.0		dB
Output 3 rd Order Intercept			10.0		dBm
Mixer RF Return Loss			15.0		dB
Mixer LO Return Loss			10.0		dB
LO Input Power			-6.0		dBm
LO to IF Isolation			40.0		dB
LO to RF Isolation			5.0		dB
RF to IF Isolation			40.0		dB
Supply Current			4.0		mA

Note 1: Test Conditions: V_{dd}=3.75V, T_a=25C, RF=881MHz, LO=966MHz, IF=85MHz, LO input=-6dBm: unless otherwise specified.

Absolute Maximum Ratings

Parameter	Value	Units
DC Power Supply	8.0	V
RF Input Power	+10	dBm
Operating Temperature	-40 to 85	C
Storage Temperature	-55 to 150	C

TQ9223C

Data Sheet

Typical Performance

Test Conditions (Unless Otherwise Specified: $V_{dd}=3.75V$, $T_a=25^{\circ}C$, filter IL=3.0dB, RF=881MHz, LO=966MHz, IF=85MHz, LO input=-6dBm)

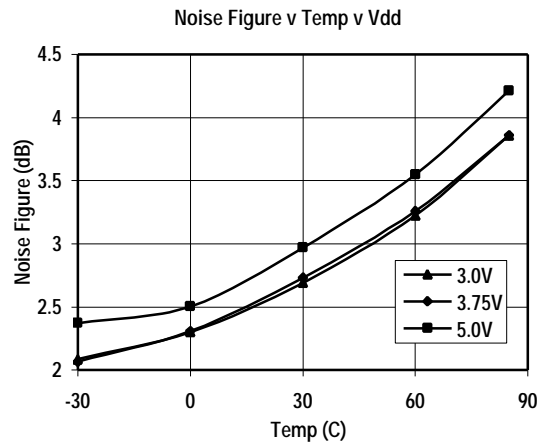
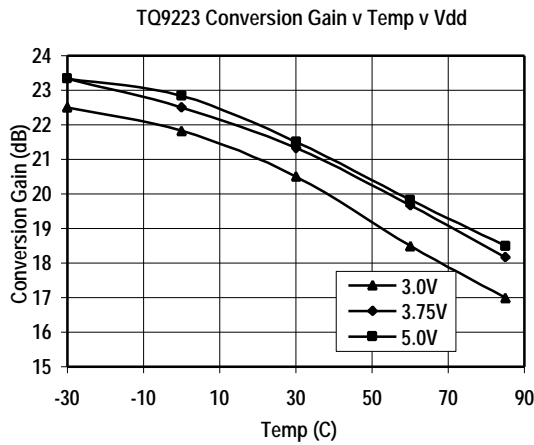
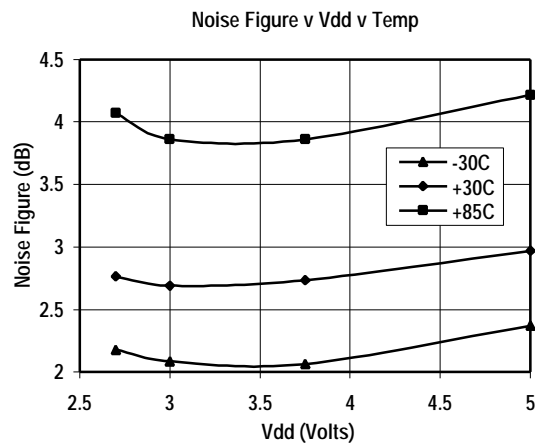
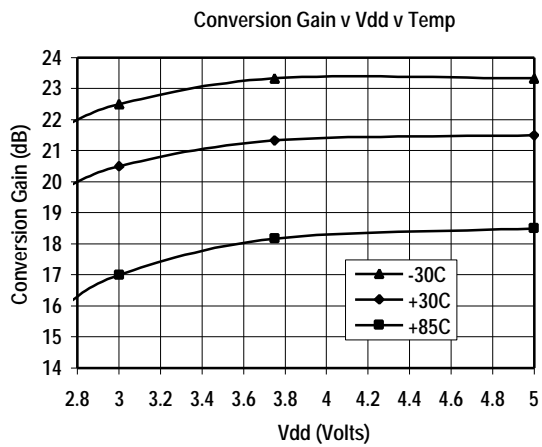
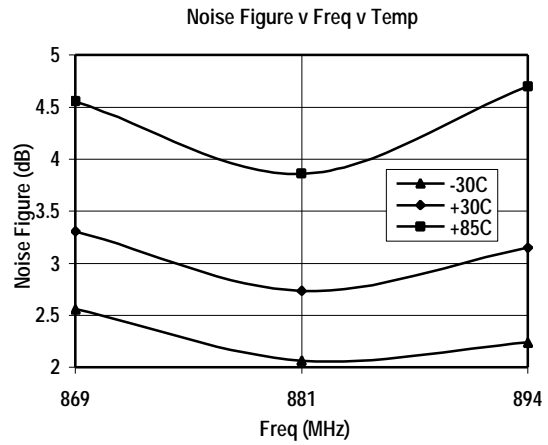
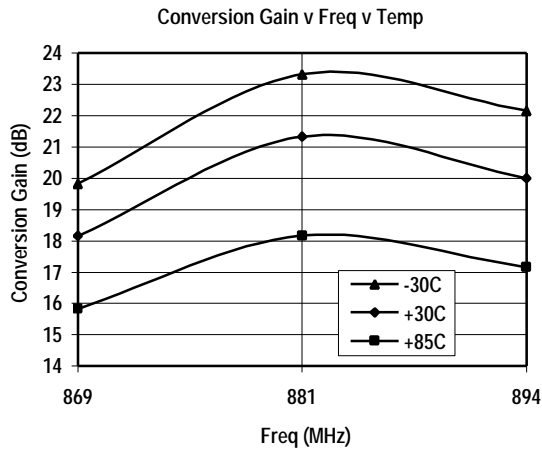

TQ9223C

Data Sheet

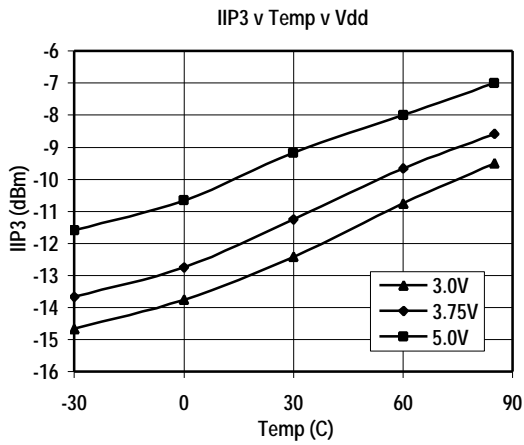
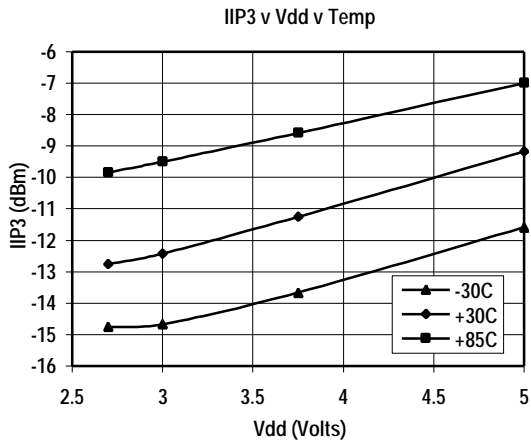
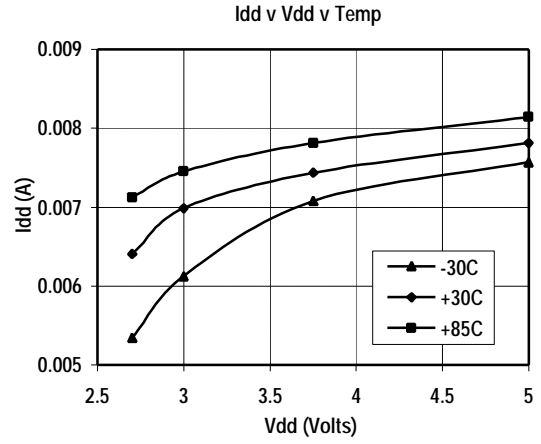
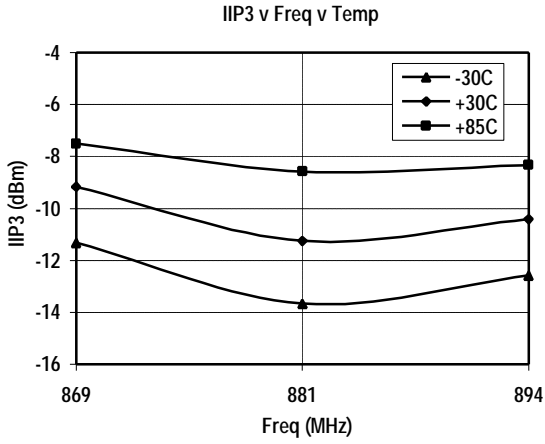

TQ9223C
Data Sheet

LNA S-Parameters, VDD=3.75V

Freq	S11	<S11	S21	<S21	S12	<S12	S22	<S22
0.100	0.99	-5	2.99	172	0.002	93	0.97	-3
0.200	0.98	-11	2.97	165	0.003	87	0.97	-5
0.300	0.97	-16	2.96	158	0.005	84	0.96	-7
0.400	0.95	-22	2.93	150	0.006	81	0.95	-9
0.500	0.94	-27	2.90	143	0.008	79	0.95	-12
0.600	0.91	-33	2.88	136	0.009	75	0.94	-14
0.700	0.89	-39	2.82	129	0.010	74	0.93	-16
0.800	0.86	-44	2.79	122	0.012	71	0.92	-19
0.900	0.83	-50	2.75	114	0.013	68	0.91	-21
1.000	0.80	-56	2.69	107	0.014	66	0.90	-23
1.100	0.77	-61	2.65	101	0.015	64	0.89	-25
1.200	0.74	-67	2.63	94	0.017	61	0.88	-27
1.300	0.70	-72	2.49	86	0.017	59	0.88	-29
1.400	0.67	-78	2.49	81	0.019	58	0.87	-30
1.500	0.63	-84	2.45	73	0.019	55	0.85	-31
1.600	0.60	-91	2.34	67	0.020	54	0.85	-32
1.700	0.56	-98	2.32	61	0.022	53	0.85	-32
1.800	0.52	-105	2.27	53	0.022	51	0.84	-33
1.900	0.48	-114	2.14	47	0.024	51	0.83	-34
2.000	0.44	-123	2.13	41	0.025	48	0.82	-35

LNA Noise Parameters, Vdd=3.75V

Freq	Fmin	Gopt (mag)	Gopt (ang)	Rnoise
0.500	0.618	0.678	10.7	0.59
0.750	0.791	0.656	27.9	0.51
0.900	1.102	0.573	34.3	0.45
1.225	1.311	0.548	48.4	0.42
1.575	1.292	0.522	63.5	0.38
1.900	1.408	0.429	73.6	0.30

Mixer S-Parameters, 3.75V

Freq (GHz)	RF IN S11	RF IN <S11	LO IN S11	LO IN <S11
0.500	0.41	-22	0.12	140
0.600	0.42	-20	0.30	59
0.700	0.42	-23	0.47	28
0.800	0.41	-26	0.57	4
0.900	0.40	-30	0.61	-16
1.000	0.39	-34	0.61	-34
1.100	0.39	-38	0.58	-50
1.200	0.37	-42	0.55	-65
1.300	0.37	-47	0.51	-80
1.400	0.36	-52	0.46	-96
1.500	0.35	-57	0.43	-113
1.600	0.34	-63	0.42	-130
1.700	0.33	-70	0.41	-146
1.800	0.32	-77	0.42	-160
1.900	0.32	-85	0.44	-172
2.000	0.32	-93	0.46	180

Mixer S-Parameters, 3.75V

Freq (GHz)	Mixer IF Out S11	Mixer IF Out <S11
0.045	0.988	0.6
0.085	0.983	1.8
0.125	0.981	2.8
0.165	0.981	3.8
0.205	0.980	4.8
0.255	0.981	6.0
0.295	9.981	6.9

TQ9223C

Data Sheet

Application/Test Circuit

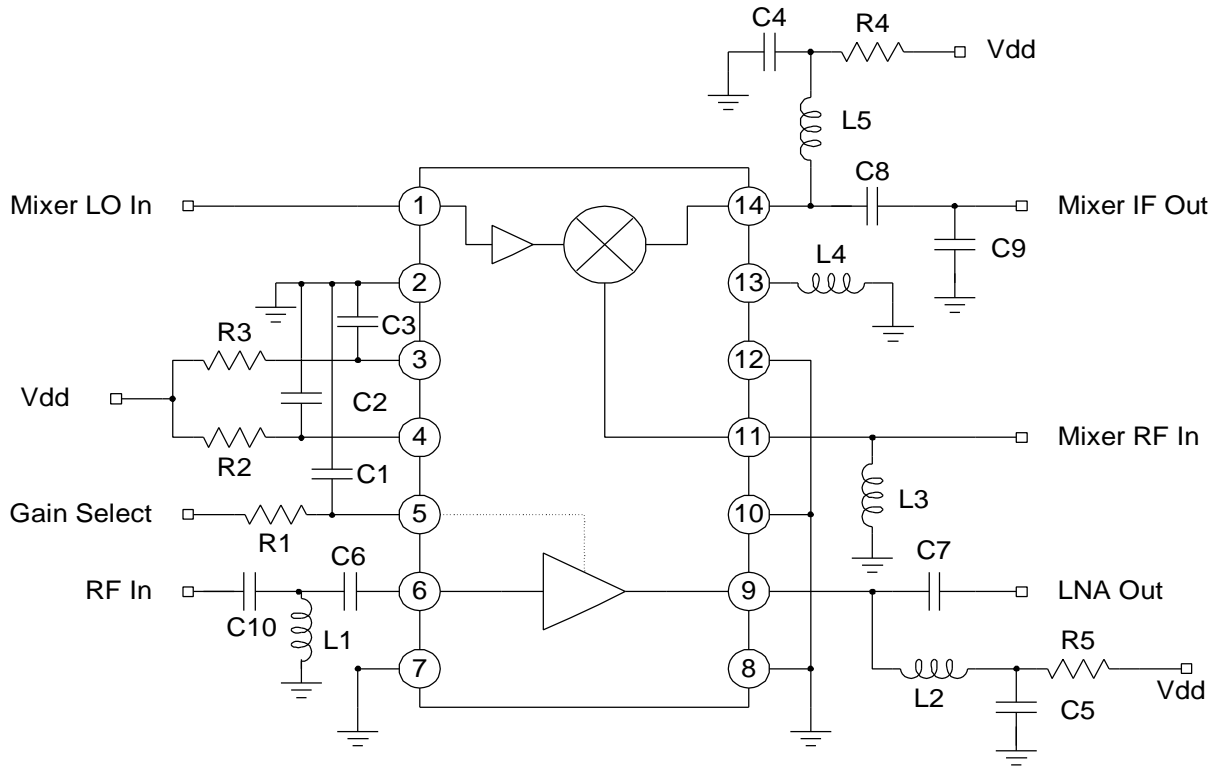

Bill of Material for TQ5121 Receiver Application/Test Circuit

Component	Reference Designator	Part Number	Value	Size	Manufacturer
Receiver IC	U1	TQ9223C		SO-14	TriQuint Semiconductor
Capacitor	C1, C2, C3, C4, C5, C6		0.01uF	0402	
Capacitor	C7		1.2pFpF	0402	
Capacitor	C8		6.0pF	0402	
Capacitor	C9		15pF	0402	
Capacitor	C10		2.7pF	0402	
Inductor	L1		6.8nH	0402	
Inductor	L2		8.2nH	0402	
Inductor	L3		33nH	0402	
Inductor	L4		12nH	0402	
Inductor	L5		470nH	0402	
Resistor	R1, R2, R3,R4, R5		10 ohm	0603	

TQ9223C Product Description

The TQ9223C efficiently integrates a low-noise amplifier and high-intercept mixer, with performance equal to a discrete implementation, through use of circuit techniques from monolithic and discrete design practices. The LNA consists of a common-source amplifier cascoded to a common-gate amplifier using a DC-stacked topology. The same DC current flows through both stages. An external noise match is used to achieve optimum noise figure. LNA input and output matching is performed with PC boards microstrip lines or lumped-element surface-mount components, using simple, well understood networks.

The mixer is implemented as a “cascode” stage operating like a dual-gate FET mixer. A common-gate LO buffer provides the necessary gain to drive the mixer FET gate and establishes a good input match. The on-chip buffer amplifier allows for direct connection to a commercial VCO at drive levels down to -6dBm . An “open collector” IF output allows for flexibility, matching to various IFs and filter types.

The two topologies efficiently use the supply current for low-power operation, approximately 10mA with a 3V supply. The overall circuit provides a distinct performance edge over silicon monolithic designs in terms of input intercept, noise figure and gain. Specifically, the circuit was intended for use in the following applications: cellular (AMPS, GSM, JDC, ETACS, etc.) and ISM band ($902 - 928\text{ MHz}$)

Operation

Please refer to the test circuit above.

Gain Select (Pin 5)

In a strong signal environment, the LNA can be shut down by applying 0V to pin 5. The result is that the LNA gain decreases from a nominal of $+18\text{dB}$ to -19dB . The current in the LNA decreases to 1mA . In addition, the input IP_3 for the LNA increases from -6dBm to $+5\text{dBm}$, and for the downconverter from -11dBm to -7.5dBm .

Power Supply Connection

The TQ9223C was designed to operate within specifications over the power supply range of 3.0 to 5.5V . The internal biasing maintains stable operating points with varying supply voltage.

Internally, the downconverter has internal capacitance from V_{dd} to ground for RF decoupling of the supply line. This should be augmented with additional decoupling capacitance: 1000pF connected externally within 5mm of the package pin. A 10-ohm series resistor in the V_{dd} line may also be added (optionally) to provide some filtering of supply line noise. Connections to ground should go directly to a low-impedance ground plane. Therefore, it is recommended that multiple via holes to the ground plane occur within 2mm on the inside of the package.

LNA Input Interfacing (Pin 6)

The TQ9223C LNA was designed for low-noise operation. It makes use of an optimum noise-matching network at the input, not a conjugate match, as would be used for maximum power transfer. Gamma optimum is referenced from the LNA input into the noise-match network in series with 50 ohms . The gamma optimum and the noise parameters for selected frequencies are shown in the LNA Noise Parameters table.

There are several options for the physical realization of gamma optimum: a series-shunt inductor microstrip transmission line network or a series capacitor/shunt inductor. The microstrip transmission lines can easily be constructed on FR-4 or G-10 circuit boards, using standard design techniques. The lumped-element components are surface-mount elements designed for RF use. It is important that the board-level circuit establishes an impedance of gamma optimum, measured at the solder pad of pin 6. Proper board design for gamma optimum eliminates the need for tuning adjustments and produces a low-noise circuit, which is tolerant of component variations.

LNA Out (Pin 9)

The TQ9223C low-noise amplifier requires external output matching to transform the amplifier's output impedance to the desired system impedance (typically 50Ω) and to provide a DC bias path. The recommended output matching circuit is illustrated in the figure above and consists of a shunt low-Q chip inductor and a series chip capacitor. The inductor provides a path for DC current to flow into the amplifier while simultaneously operating as the first element in the impedance transforming filter. The series capacitor acts as a block to DC current and operates as the final element in the impedance transforming filter.

TQ9223C

Data Sheet

A number of inductor/capacitor values can be selected that will effectively transform the LNA output impedance to the system impedance. The actual values selected will be governed by the trade-off between optimum impedance match and maximum IP3 match.

Mixer RF Input (Pin 11)

The mixer RF input is matched close to 50 ohms and is internally DC-blocked. Pin 11 may be directly connected to the filter output. The filter must be as close as possible to the mixer RF input to maintain the proper termination impedance at the LO frequency. Include a shunt inductor of 33nH at the mixer RF input to improve the mixer noise performance by providing a short to ground at the IF frequency. This provides a secondary benefit of slightly improved input match.

Mixer LO Input (Pin 1)

The mixer LO input is matched close to 50 ohms and is internally DC-blocked. Pin 1 may be directly connected to the LO input signal. A level greater than -6dBm is recommended. Standard VCO outputs of -2dBm work well.

LO Tuning (Pin 13)

A shunt L on pin 13 resonates with some internal capacitance to produce a bandpass frequency response of the LO buffer amplifier. This attenuates noise at +/- one IF frequency away from the LO frequency. The approximate value of L is determined by the following equation:

$$L=1/C (2\pi f)^2, \text{ where } C=2.2\text{pF}$$

In practice, the value (and/or placement) of L should be empirically determined for a particular layout, since stray capacitance on the PCB layout can move the resident frequency from the expected ideal. The actual value of L should be adjusted until the buffer response (pin 1-> pin 13) produces a peak at the LO frequency. A measurement of the response may be accomplished with a simple coaxial probe "sniffer," in which the end is positioned 50 – 100 mils from the inductor at pin 13. The frequency response of the LO buffer amplifier (pin 13) is directly measured on the network analyzer as the LO input (pin 1) is swept in frequency. The LO drive level should be set at approximately the operating level (-6 to -3dBm) for this

measurement. This "tuning" needs to be done only in design, not in production.

Mixer IF Interfacing

The mixer IF port is a high-impedance, open-drain output. The impedance is a few K ohms in parallel with less than 1pF capacitance. The IF port S-parameters (S11) are listed in the table over the frequency range of 45MHz to 250MHz. It is possible to use IFs above and below this range: however, at low frequencies the noise increases, and at high frequencies the LO/IF, RF/IF isolation decreases.

The open-drain output permits matching to any chosen filter impedance. In general, a conjugate impedance match is recommended on this port to achieve best power gain, noise figure and output 3rd-order intercept. It is also important to properly center the tuned circuit at the desired IF. This maximizes circuit robustness to component tolerances. For proper mixer operation, pin 14, the open-drain output, must also be biased to Vdd. A practical matching network, which includes biasing, is shown.

Package Pinout

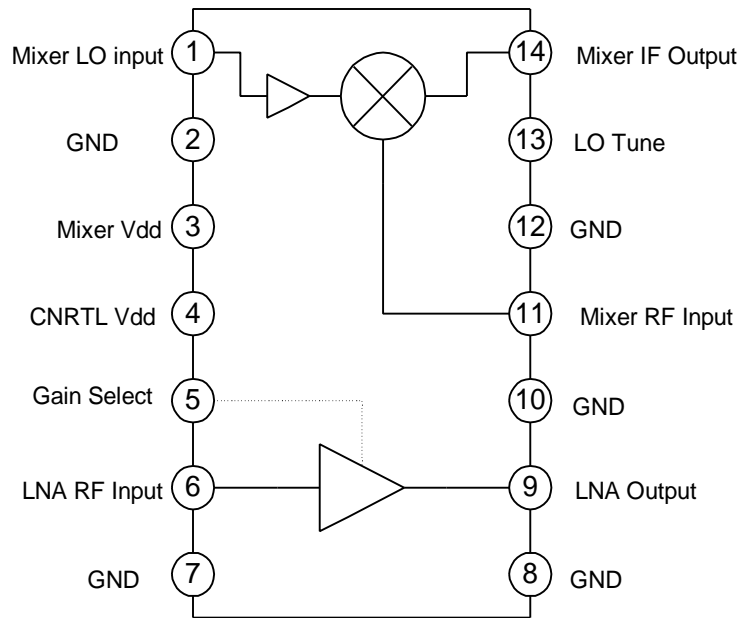

Pin Descriptions

Pin Name	Pin #	Description and Usage
Mixer LO IN	1	Mixer LO input. Matched to 50Ω. Internally DC blocked.
Mixer Vdd	3	Mixer LO buffer Vdd. Bypass cap required.
CNTRL Vdd	4	LNA gain select control Vdd. Bypass cap required.
Gain Select	5	LNA gain select line. Logic HIGH = high gain, logic LOW = low gain
RF IN	6	LNA RF Input port. Noise matching required. External DC blocking required.
LNA Out	9	LNA Output port. Open drain output requires connection to Vdd and optimal impedance matching.
Mixer RF IN	11	Mixer RF Input port. Matched to 50Ω. Internally DC blocked.
LO Tune	13	LO buffer tuning, inductor to ground.
Mixer IF Out	14	Mixer IF signal port. Open drain output requires connection to Vdd and impedance matching to load.
GND	2,7,8, 10,12	Ground connection. Keep physically short for stability and performance. Use several via holes immediately adjacent to the pins down to backside ground plane.

TQ9223C

Data Sheet

Package Type: SO-14 Plastic Package

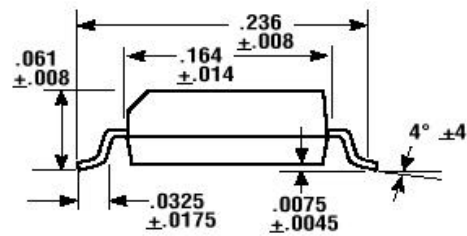
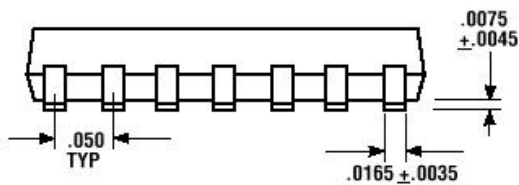
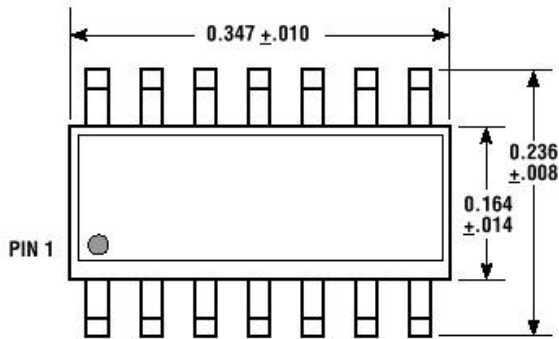

Dimensions in inches

Additional Information

For latest specifications, additional product information, worldwide sales and distribution locations, and information about TriQuint:

Web: www.triquint.com

Tel: (503) 615-9000

Email: info_wireless@tqs.com

Fax: (503) 615-8900

For technical questions and additional information on specific applications:

Email: info_wireless@tqs.com

The information provided herein is believed to be reliable; TriQuint assumes no liability for inaccuracies or omissions. TriQuint assumes no responsibility for the use of this information, and all such information shall be entirely at the user's own risk. Prices and specifications are subject to change without notice. No patent rights or licenses to any of the circuits described herein are implied or granted to any third party.

TriQuint does not authorize or warrant any TriQuint product for use in life-support devices and/or systems.

Copyright © 1998 TriQuint Semiconductor, Inc. All rights reserved.

Revision C, April 9, 1999