

GSM/EDGE Multi-mode Power Amplifier Module

Functional Block Diagram

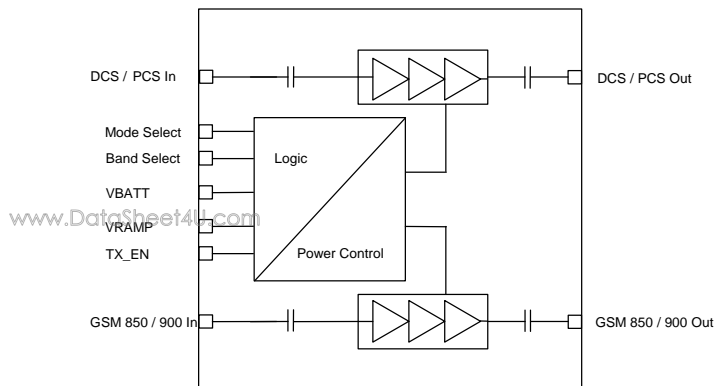

Product Description

The TQM7M5005 is an extremely small (5x5x1.0mm³) multi-mode power amplifier module for GSM/EDGE applications. This module has been optimized for high EDGE efficiency and EDGE power class E2 operation while maintaining high GSM/GPRS efficiency. In EDGE mode, the Vramp pin provides a continuously variable bias control to minimize current consumption during backed-off power conditions.

The module incorporates two highly integrated InGaP power amplifier die with a CMOS controller. The CMOS controller implements a fully integrated closed-loop power control within the module for GSM Operation. This eliminates the need for any external couplers, power detectors, current sensing etc., to assure the output power level. The latter is set directly from the Vramp input from the DAC. The module has Tx enable, band select, mode (EDGE or GSM) inputs. Module construction is a low-profile over-molded land-grid array on laminate.

Electrical Specifications

Parameter	850 Band	900 Band	DCS Band	PCS Band	Units
	Typ	Typ	Typ	Typ	
GSM Pout	35	35	33	33	dBm
Efficiency	55	55	49	49	%
Pin	3	3	3	3	dBm
EDGE Pout	28.5	28.5	28	28	dBm
Efficiency	24	24	25	25	%
Gain	32	32	34	34	dB
ACPR (400KHz)	62	62	62	62	dBc

Features

- Very compact size – 5x5x1.0 mm³.
- High GSM efficiency – GSM 850 55%, GSM900 55%, DCS 49%, PCS 49%.
- High EDGE efficiency – GSM 850 24%, GSM 900 24%, DCS 25%, PCS 25%
- Positive supply voltage – 3.0 to 4.5 V
- 50 Ω input and output impedances
- GPRS class 12.
- CMOS band select and internal closed-loop power control for GSM Operation.
- High-reliability InGaP technology.
- Ruggedness 10:1
- No external Vref Required

Applications

- GSM/EDGE handsets
- GSM/EDGE wireless cards & data links

Package Style

Package Size: LGA 5 x 5 x 1.0 mm
Top View

