

Product Description:

The TQP2420G is a high performance, high linearity, medium-power amplifier designed for 802.11b/g WLAN and other applications in the 2.4GHz ISM band. The device exhibits industry-leading power added efficiency under 802.11b and 802.11g modulated signals. The power amplifier is manufactured using TriQuint's InGaP HBT process and is packaged in an industry standard 3mm x 3mm VQFN-12 package.

Selected Electrical Specifications:

Parameter	min	typ	max	units
Frequency Range	2400	-	2500	MHz
Power Gain	28	29		dB
Linear Output Power (802.11g modulation)		19		dBm
Error Vector Magnitude (Pout = +19dBm, 54Mbps OFDM Signal)		2		%
Linear Output Power (guaranteed ACP under 802.11b modulation)	22	23		dBm
802.11b ACP; +22.0 dBm Output; 1 st Side Lobe		-35		dBc
802.11b ACP; +22.0 dBm Output; 2 nd Side Lobe		-56		dBc

Test Conditions: Ta=25°C; Vref= 2.95V; Vcc=Vc1=Vc2=3.3V

2.4GHz ISM Band InGaP HBT Power Amplifier

Features

- High Linearity, 2.4 GHz ISM Band PA for 802.11b/g WLAN Systems
- Integrated Output Power Detector
- Leadless 3.0 x 3.0 mm SMT Package
- Temperature Compensated Bias Network with Bias Shutdown Mode
- EVM < 2% @ +19dBm Linear Output Power 802.11g modulation
- +23 dBm Linear Output Power 802.11b modulation

Applications

- 802.11b/g WLAN
- 2.4GHz ISM Band Applications
- Cordless Phones
- Broadband Systems

TQP2420G

Datasheet

Absolute Maximum Ratings

Parameter	Symbol	Value		Unit
		min	max	
Power Supply Voltage (no RF applied)	Vc1, Vc2, Vcc		6.0	V
Power Supply Voltage (RF applied)	Vc1, Vc2, Vcc		5.0	V
Reference Voltage	Vref		3.0	V
Power Dissipation	Pdiss			W
Case Temperature, Survival	Tc	-40	100	°C
Storage Temperature	Ta	-40	150	°C
Operating Temperature Range	Toper	-40	85	°C
RF Input Power	Pin		+5dBm	dBm

General Electrical Characteristics^{1,2}

Parameter	min	typ	max	Unit
Frequency Range	2400	-	2500	Mhz
Output Power @ 1dB Gain Compression		24		dBm
Power Gain	28	29		dB
Linear Output Power (802.11g modulation)		19		dBm
Error Vector Magnitude (Pout=+19dBm, 54Mbps OFDM Signal)		2		%
Linear Output Power (guaranteed ACP under 802.11b modulation)	22	23		dBm
Gain Variation vs. Frequency		0.4		dB p-p
Power Added Efficiency @ Linear Output Power = +22dBm, with 802.11b CCK modulation		35		%
802.11b Adjacent Channel Power @ +22.0 dBm Output power – 1 st Side Lobe		-35		dBc
802.11b Adjacent Channel Power @ +22.0 dBm Output power – 2 nd Side Lobe		-56		dBc
Input VSWR with external matching)			2:1	

¹Test Conditions: $T_a=25^{\circ}\text{C}$, $V_{ref}=2.95\text{V}$, $V_{cc}=V_{c1}=V_{c2}=3.3\text{V}$

²AC performance is guaranteed at 25 Deg-C, $V_{cc}=V_{c1}=V_{c2}=3.3\text{V}$, $V_{ref}=2.95\text{V}$

DC Electrical Performance* At Vref=2.95V typical

Parameter,	min	typ	max	Unit
Operating Voltage Supply Range	3.0	3.3	3.6	V
Supply Current: $T_a = 25^\circ\text{C}$, $V_{cc}=V_{ref}=2.95$ $V_{c1}=V_{c2}= 3.3\text{V}$ Linear Output Power = 19dBm, with 802.11g 54Mbps modulation		130		mA
Supply Current: $T_a = 25^\circ\text{C}$, $V_{cc}=V_{ref}=2.95$ $V_{c1}=V_{c2}= 3.3\text{V}$ Linear Output Power = 22dBm, with 802.11b CCK modulation		180		mA
Vref	2.85	2.95	3.0	
I_{vref}		2		mA
Shutdown Mode Current		<1		uA
Quiescent current*		60		mA

TQP2420G

Datasheet

Schematic

TL13	2.8 Deg
TL6	19.7 Deg
TL11	2.8 Deg
TL3	2.8 Deg
TL1	2.8 Deg
TL 5	18.8 Deg

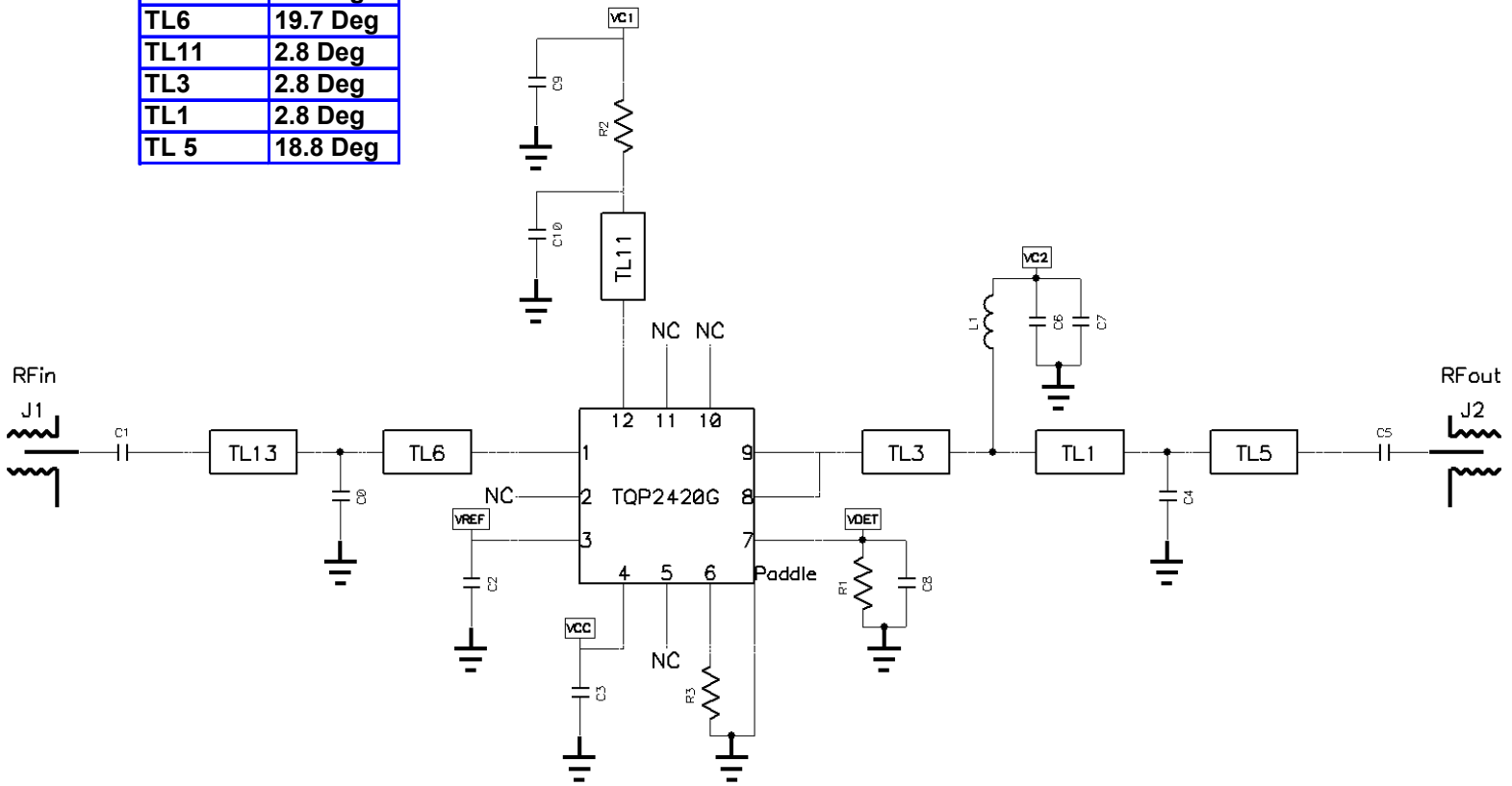

Pin Assignments

Pin	Symbol	Description
1	RFin	RF Input
2	N/C	
3	Vref	Bias Reference voltage
4	Vcc*	Bias circuit supply voltage,
5	N/C	
6	GND	Ground
7	Vdet	Power detector output voltage
8	RFout, Vcc2	RF Output and 2 nd stage collector supply voltage
9	RFout, Vcc2	RF Output and 2 nd stage collector supply voltage
10	N/C	
11	N/C	
12	Vcc1	1 st stage collector supply voltage
	GND	Backside Paddle

*Vcc may be connected directly to Vc1 or Vc2 on DC side of RF Choke

Evaluation Board-WLAN PA; 242x Evaluation board

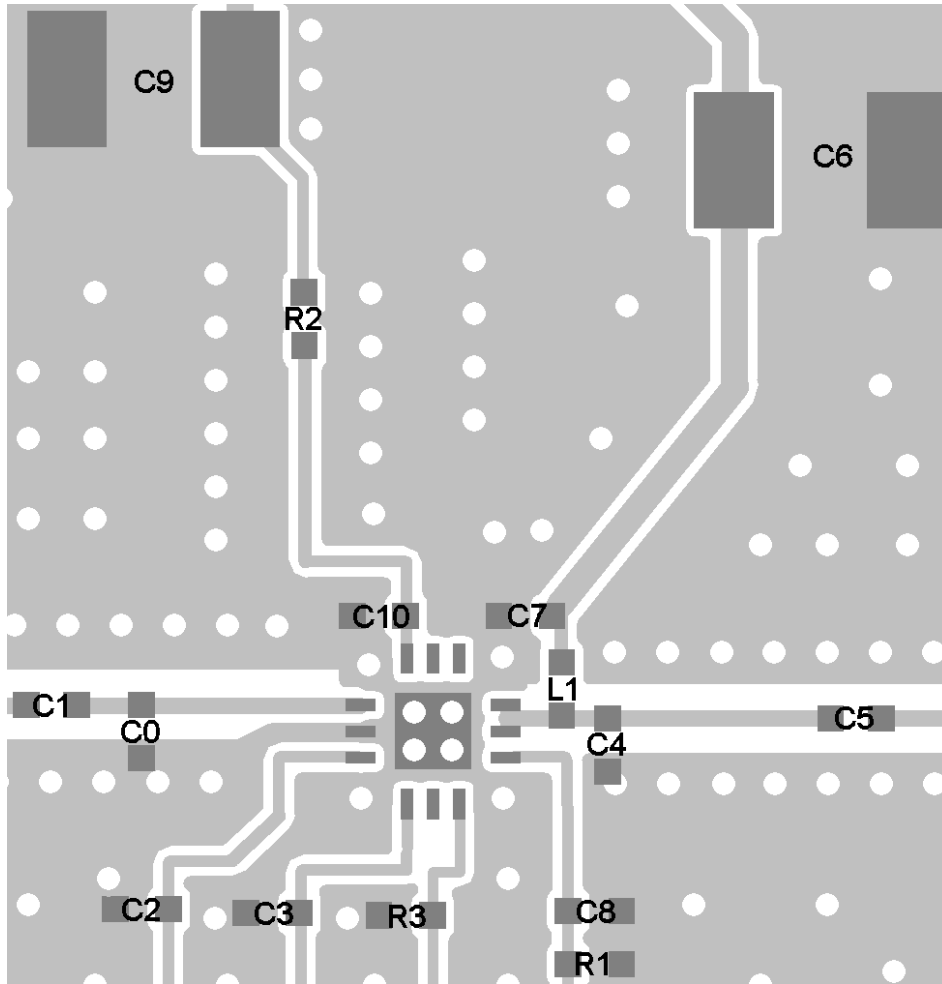

Layer/Descriptions
 Dielectric: FR4: Er=4.6
 Top: 1 oz. Plated Copper
 Dielectric 1 : 6 mils
 Mid 1: 1 oz. Copper
 Dielectric 2: 28 mils
 Mid 2: 1 oz. Copper
 Dielectric 3: 6 mils
 Bottom: 1 oz. Plated Copper

Bill of Materials

		Evaluation Board		242X					
		Integrated Circuit ID		TQP2420					
Part #	Quantity	Component ID	Size	Value	Units	Manufacturer	P/N	Comments	
1	1	C0	0402	1.2	pF	Skywell	042CG1R2C500BA		
2	1	C5	0402	1.5	pF	Skywell	042CG1R5C500BA		
3	1	C1	0402	2.2	pF	Rohm	MCH155A2R2CK		
4	3	C2,C3,C7	0402	0.033	uF	Murata	GRP155R71A333KA01B		
5	1	C4	0402	2.7	pF	Rohm	MCH155A2R7CK		
6	2	C6,C9	.130x.070	10	uF	Murata	GJ232RF51E106ZD01K		
7	1	C10	0402	22	pF	Murata	GRP1555C1H220JZ01B		
8	1	R1	0402	10000	ohms	Rhom	MCR01J133		
9	1	R2	0402	0	ohms	Rhom			
10	1	R3	0402	0	ohms	Rohm			
11	1	L2	0402	6.8	nH	Toko	LL1005-FH6N8J		
12	1	C8	0402	10	pF	Murata	GRP1555C1H100JZ01B		
13	1	Q1	MLF		N/A	Triquint	TQP2420G		
14	2	J1,J2				Johnson	142-0711-881		
15	2	J3,J4						DC Connector	
16	1	PCB					242X	Printed circuit board	

TQP2420G

Datasheet

TQP2420G measured Small Signal performance; in TriQuint WLAN242X Evaluation Board

Measurement Conditions: $T_a = 25^\circ\text{C}$, $V_{ref}=2.95$ $V_{cc}=V_{c1}=V_{c2}= 3.3\text{V}$, Sample size 9 Units

S11
TQP2420G
3 samples

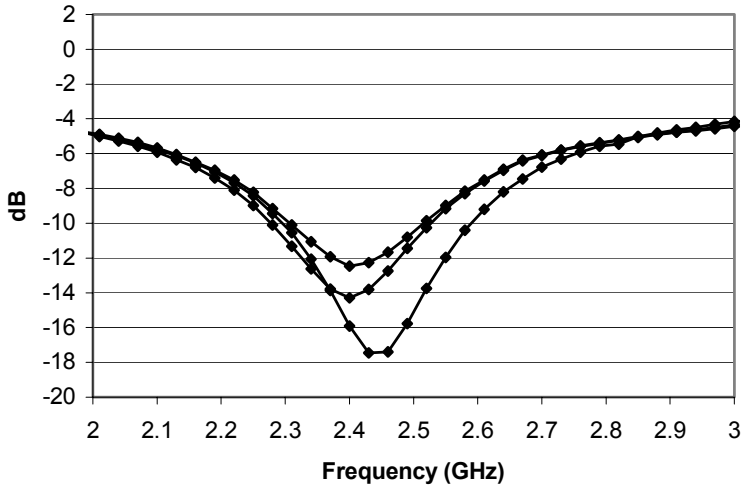

S21
TQP2420G
3 samples

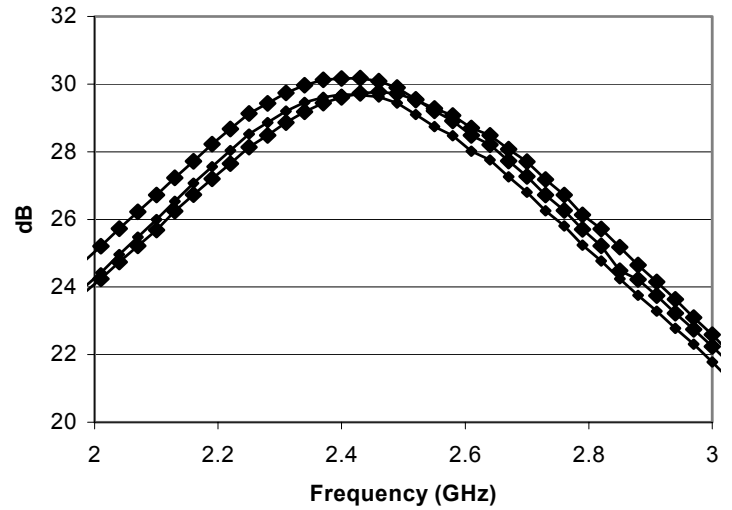

S12
TQP2420G
3 samples

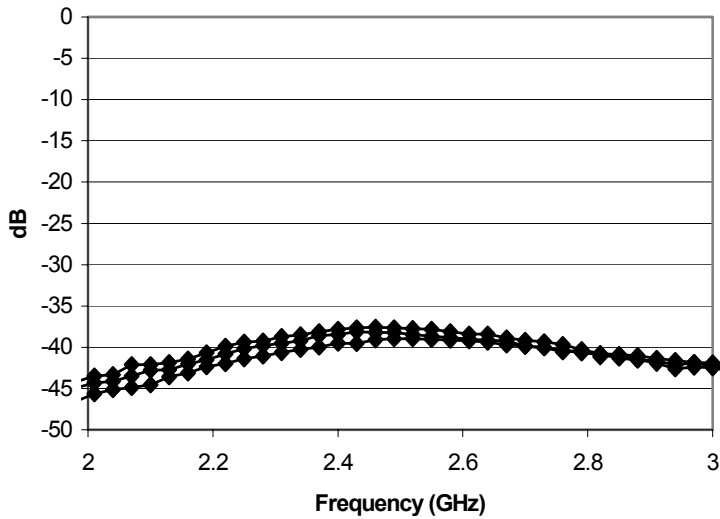

S22
TQP2420G
3 samples

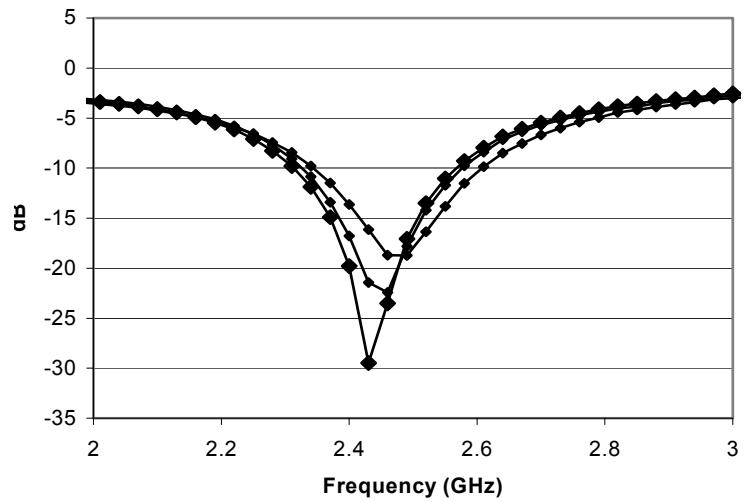

TQP2420G measured 802.11g performance; in TriQuint WLAN242X Evaluation Board- Continued
Measurement conditions: $T_a = 25^\circ\text{C}$, $V_{ref}=2.9$, $V_{cc}=V_{c1}=V_{c2}= 3.3\text{V}$, $f=2450\text{Mhz}$

TQP2420G

Measured EVM vs Output power
802.11g 54mbps
 $f=2.45\text{ GHz}$
S/N 55

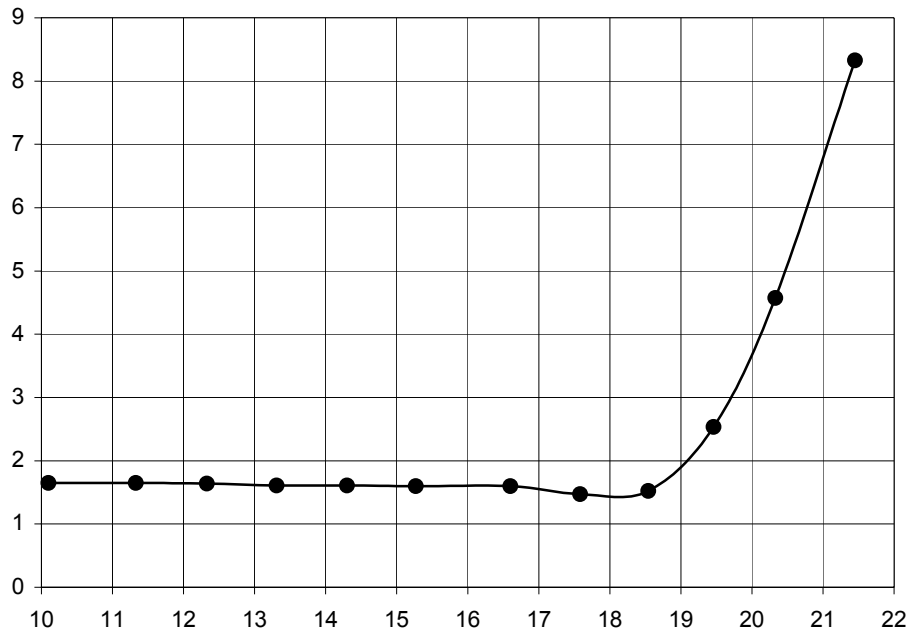

$I_{tot} = 132\text{mA}$ @ $P_{out} = +19\text{dBm}$, 54Mbps OFDM Signal

TQP2420G

Datasheet

TQP2420G measured 802.11b performance; in TriQuint WLAN242X Evaluation Board- Continued

Measurement conditions: $T_a = 25^\circ\text{C}$, $V_{ref}=2.9$, $V_{cc}=V_{c1}=V_{c2}= 3.3\text{V}$, $f=2450\text{Mhz}$

Transmit Spectral Mask-Typical performance

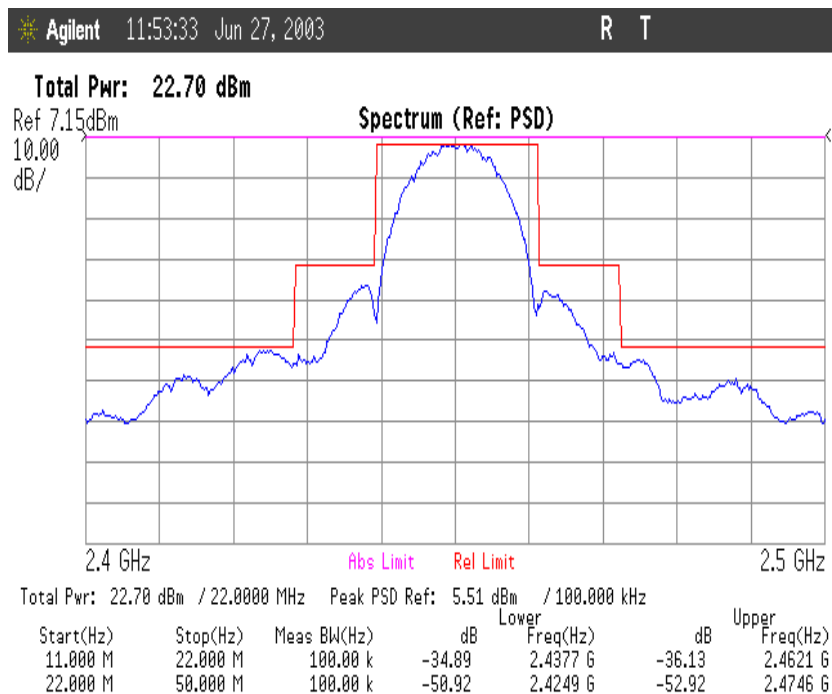

For additional information and latest specifications, see our website: www.triquint.com
 TQP2420G Preliminary Datasheet rev 4.0; February 20, 2004.

TQP2420G measured performance; in TriQuint WLAN242X Evaluation Board- Continued

Measurement conditions $T_a = 25^\circ\text{C}$, $V_{ref}=2.9$, $V_{cc}=V_{c1}=V_{c2}= 3.3\text{V}$

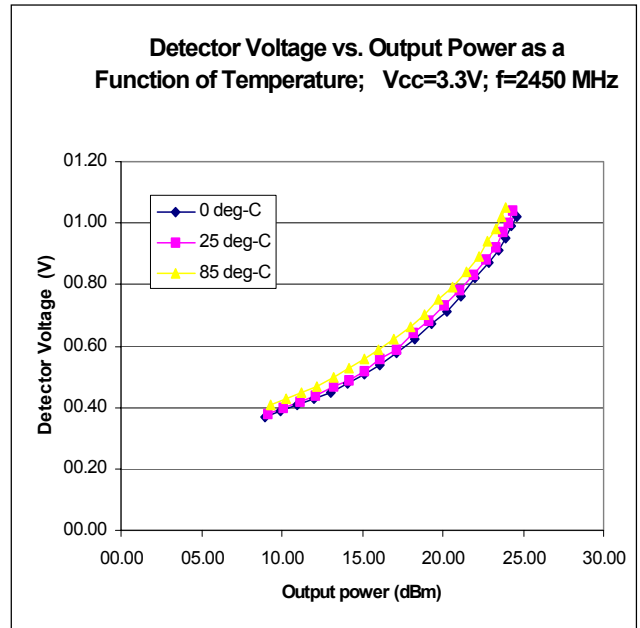
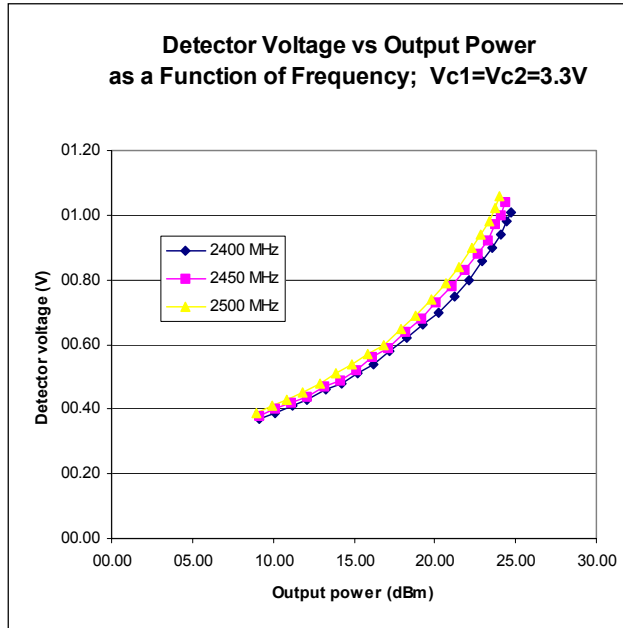

TQP2420G

Datasheet

Application Data

External matching

•The 50 Ohm match of the input and output ports of the TQP2420G is completed by the addition of a small number of external components. The optimum impedance presented to the respective ports is described in the Smith Chart plot at the right.

•The impedance shown can be achieved by a number of topologies. The preferred topology selected for Triquint 242x evaluation board is shown in the schematic.

Source

Load

m1
freq=2.480GHz
S(2,2)=0.750 / 177.603
impedance = $Z_0 * (0.143 + j0.020)$

m2
freq=2.480GHz
S(1,1)=0.739 / -168.987
impedance = $Z_0 * (0.151 - j0.094)$

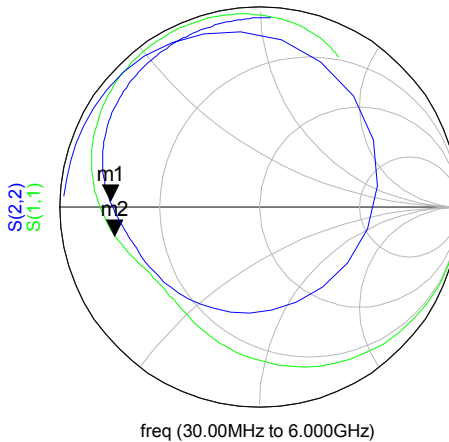

Source

Load

freq	S(1,1)
30.00MHz	0.999 / -3.957
230.0MHz	0.967 / -29.806
430.0MHz	0.903 / -53.507
630.0MHz	0.829 / -74.166
830.0MHz	0.761 / -91.703
1.030GHz	0.706 / -106.400
1.230GHz	0.666 / -118.632
1.430GHz	0.640 / -128.809
1.630GHz	0.630 / -137.406
1.830GHz	0.635 / -144.982
2.030GHz	0.654 / -152.132
2.230GHz	0.687 / -159.368
2.430GHz	0.728 / -167.002
2.630GHz	0.773 / -175.121
2.830GHz	0.819 / 176.361
3.030GHz	0.860 / 167.614
3.230GHz	0.896 / 158.820
3.430GHz	0.925 / 150.128
3.630GHz	0.948 / 141.643
3.830GHz	0.964 / 133.423
4.030GHz	0.975 / 125.491
4.230GHz	0.981 / 117.850
4.430GHz	0.982 / 110.485
4.630GHz	0.980 / 103.380
4.830GHz	0.973 / 96.518
5.030GHz	0.963 / 89.892
5.230GHz	0.948 / 83.512
5.430GHz	0.929 / 77.411
5.630GHz	0.905 / 71.655
5.830GHz	0.877 / 66.344
6.000GHz	0.852 / 62.271

freq	S(2,2)
30.00MHz	0.981 / 176.647
230.0MHz	0.972 / 155.219
430.0MHz	0.950 / 127.187
630.0MHz	0.844 / 82.634
830.0MHz	0.601 / 10.089
1.030GHz	0.509 / -68.802
1.230GHz	0.556 / -114.349
1.430GHz	0.598 / -138.063
1.630GHz	0.627 / -152.220
1.830GHz	0.651 / -161.741
2.030GHz	0.678 / -168.936
2.230GHz	0.708 / -175.101
2.430GHz	0.741 / 179.055
2.630GHz	0.774 / 173.238
2.830GHz	0.804 / 167.397
3.030GHz	0.830 / 161.580
3.230GHz	0.852 / 155.844
3.430GHz	0.870 / 150.230
3.630GHz	0.884 / 144.755
3.830GHz	0.895 / 139.422
4.030GHz	0.905 / 134.221
4.230GHz	0.912 / 129.140
4.430GHz	0.919 / 124.164
4.630GHz	0.924 / 119.274
4.830GHz	0.929 / 114.457
5.030GHz	0.933 / 109.694
5.230GHz	0.937 / 104.969
5.430GHz	0.941 / 100.267
5.630GHz	0.944 / 95.573
5.830GHz	0.948 / 90.874
6.000GHz	0.951 / 86.866

Device Junction Temperature

•The plot is an estimate of the first and second stage transistor temperatures for an amplifier biased at a collector voltage of 3.3V and Vref= 2.95V. The paddle temperature is +85 deg-C. The actual temperature will vary dependent on the method used to attach the package to the final assembly board.

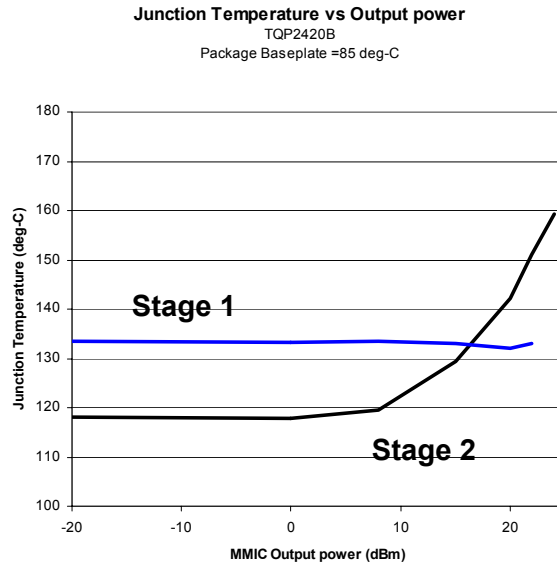

TQP2420G

Datasheet

Package Outline

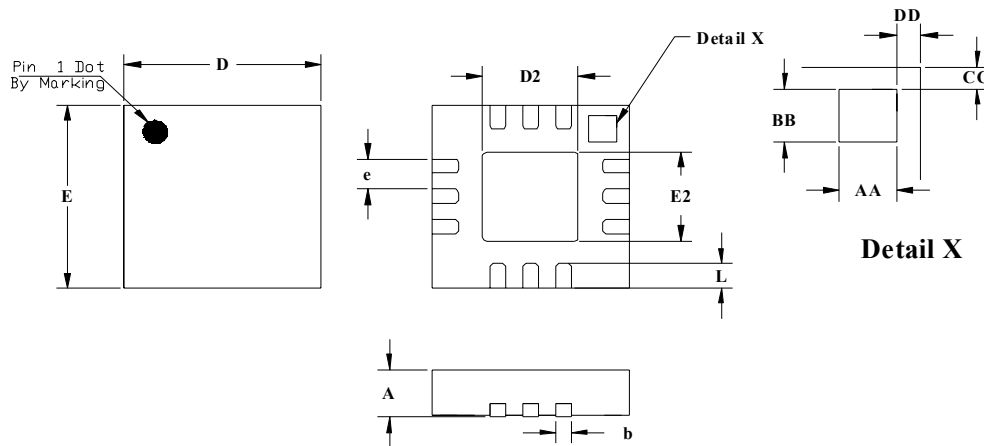

JEDEC DESIGNATION	DESCRIPTION	METRIC	ENGLISH	NOTE
A	OVERALL HEIGHT	0.90 +/- .10 mm	.035 +/- .004 in	1
b	TERMINAL WIDTH	0.23 +/- .07 mm	.009 +/- .003 in	1
D	PACKAGE LENGTH	3.00 mm BSC	.118 in	1
D2	EXPOSED PAD LENGTH	1.45 +/- .10 mm	.057 +/- .004 in	1
e	TERMINAL PITCH	0.50 mm BSC	.020 in	1
E	PACKAGE WIDTH	3.00 mm BSC	.118 in	1
E2	EXPOSED PAD WIDTH	1.45 +/- .10 mm	.057 +/- .004 in	1
L	TERMINAL LENGTH	0.40 +/- .10 mm	.016 +/- .004 in	1
AA	PIN 1 ID LENGTH	0.43 mm BSC	.017 in	1
BB	PIN 1 ID WIDTH	0.43 mm BSC	.017 in	1
CC	PIN 1 ID TO EDGE	0.18 mm BSC	.007 in	1
DD	PIN 1 ID TO EDGE	0.18 mm BSC	.007 in	1

Notes:
 1. PRIMARY DIMENSIONS ARE IN METRIC MILLIMETERS. THE ENGLISH EQUIVALENTS ARE CALCULATED AND SUBJECT TO ROUNDING ERROR.

Package Marking

Pin 1



Line 1: 2420
Line 2: XXXX TriQuint Assembly Lot Number
Line 3: Manufacturing year and work week

Ordering Information:

Type	Marking	Package
TQP2420G	2420	VQFN-12

Caution: Electrostatic discharge sensitive. Observe handling Precautions!

Additional Information

For latest specifications, additional product information, worldwide sales and distribution locations, and information about TriQuint:

Web: www.triquint.com **Tel:** (503) 615-9000
Email: info_wireless@tqs.com **Fax:** (503) 615-8902

For technical questions and additional information on specific applications:

Email: info_wireless@tqs.com

The information provided herein is believed to be reliable; TriQuint assumes no liability for inaccuracies or omissions. TriQuint assumes no responsibility for the use of this information, and all such information shall be entirely at the user's own risk. Prices and specifications are subject to change without notice. No patent rights or licenses to any of the circuits described herein are implied or granted to any third party.

TriQuint does not authorize or warrant any TriQuint product for use in life-support devices and/or systems.

Copyright © 2003 TriQuint Semiconductor, Inc. All rights reserved.

Revision 4.0; February 20, 2004