

 **KENWOOD / TRIO**

SERVICE MANUAL

Model TR-7010



Downloaded by
RadioAmateur.EU

2m SSB TRANSCEIVER

CONTENTS

SPECIFICATIONS	3
BLOCK DIAGRAM	4
FEATURES	4
CIRCUIT DESCRIPTION	5
PARTS ALIGNMENT	7
PC BOARD	
CARRIER UNIT (X50-1230-00).....	9
FINAL UNIT (X45-1040-00).....	9
SYNTHESIZER UNIT (X50-1240-00).....	10
RX UNIT (X55-1080-00).....	11
FILTER UNIT (X51-1110-00).....	11
PARTS LIST	
TR-7010.....	12
FINAL UNIT.....	13
CARRIER UNIT.....	13
SYNTHESIZER UNIT.....	14
FILTER UNIT.....	16
RX UNIT.....	16
TROUBLESHOOTING	19
LEVEL DIAGRAM	21
ADJUSTMENTS	23
CHANNEL INSTALLATION	29
REFERENCE	30
SCHEMATIC DIAGRAM	31

SPECIFICATIONS

GENERAL

Semiconductor:	34 transistors, 12 FETs, 72 diodes
Frequency Range:	144.0 ~ 145.0MHz
Number of Built-in Channels:	40 channels
Frequency Range of Built-in Channel:	A band 144.100 ~ 144.195MHz B band 144.200 ~ 144.295MHz
Operating Temperature:	-20°C ~ +60°C
Standard Power Supply Voltage:	DC 13.8V
Working Voltage:	DC 11.5 ~ 16.0V
Grounding:	Negative grounding
Antenna Impedance:	50Ω
Power Consumption:	40VA (DC 13.8V) Approx. 600mA in receive with no input signal Approx. 3A in transmit
Dimensions:	180(W) × 60(H) × 240(D) mm
Weight:	2.7kg

TRANSMIT SECTION

Type of Emission:	A1, A3J (USB)
Rated Input:	13.5V 20W
Rated Output:	8W
Modulation:	Balanced modulation
Spurious Radiation:	Less than -60dB
Carrier Suppression Ratio:	More than 40dB
Side-band Suppression Ratio:	More than 40dB
Microphone and Sensitivity:	500Ω, dynamic type, with press-talk switch, -72dB ±3dB
Transmit Frequency Characteristic:	Characteristic — 500 ~ 2500Hz (-6dB)

RECEIVE SECTION

Receiving System:	Single superheterodyne
Intermediate Frequency:	10.7MHz
Sensitivity:	0.5μV (S/N = better than 10dB)
Image Rejection:	More than 60dB
Spurious Interference:	More than 60dB
Pass Band Width:	Less than 2.4kHz (at -6dB)
Selectivity:	Less than 4.8kHz (at -60dB)
Audio Output:	More than 1.5W (10% distortion, 8Ω load)

BLOCK DIAGRAM / FEATURES

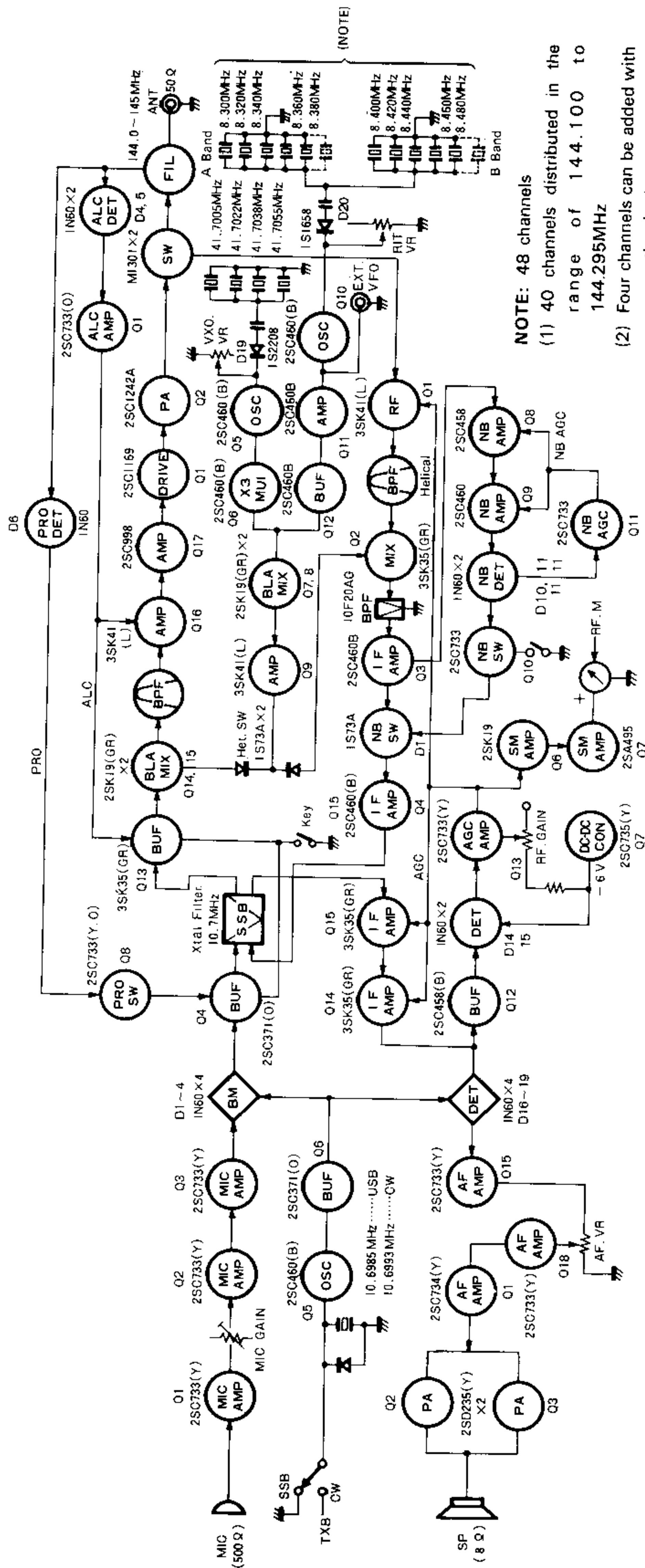

1. All solid-state, handy SSB car transceiver which operates in the band of 144MHz.
2. TR-7010 which operates in SSB (A₃J) and CW (A₁) modes is so designed as to serve as a fixed station.
3. By the adoption of a frequency synthesizer 40 channels at intervals of 5kHz are provided.
4. AUX circuit has 18 channels, and it is possible to add another 4 channels with one crystal.
5. An external VFO connection terminal is provided.
6. Kenwood's unique noise blanker circuit whose high performance in the HF range has proven effectively eliminates noise arising from ignition.
7. A pre-mixer and a balanced type HET mixer with FET are used to prevent spurious responses during transmission.
8. A six-element crystal filter is used in the IF stage so that a high level of selectivity is obtained.
9. An RF gain control of threshold type is used to obtain an optimum S/N ratio throughout SSB reception.
10. AGC circuit of amplifier type is used to obtain distortion less sound during reception, and ALC circuit is used to inhibit splatter and minimize wave distortion during transmission.
11. "ON AIR" pilot lamp which lights during transmission is provided.
12. RIT circuit with ON-OFF switch permits the frequency of only the incoming signal to be varied by about ± 1.5 kHz.
13. Fittings for car mounting, power cord, stand, microphones and all other necessary accessories are provided.
14. VXO circuit permits both the transmit and reception frequencies to be varied by ± 2.5 kHz or more at the same time, so that TR-7010 can continuously cover all the frequencies of 40 channels divided at intervals of 5kHz.

CIRCUIT DESCRIPTION

GENERAL:

TR-7010 is composed of 34 transistors, 12 FETs and 72 diodes. The block diagram is shown on Page 4. The following are the major functional units contained in TR-7010:

Types of Units and Arrangement:

1. Synthesizer unit (X50-1240-00) Upper side
2. RX unit (X55-1080-00) Lower side
3. Carrier unit (X50-1230-00) Lower side
4. Final unit (X45-1040-00) Upper side
5. Filter unit (X51-1110-00) Lower side

In the synthesizer unit, 4 crystals for 41MHz band and 10 crystals for 8MHz band are combined to provide 40 channels of 133MHz band. The frequency obtained is fed to the transmit and receive MIX circuits by means of the diode switch, as a heterodyne signal.

In the transmitting section, SSB signal of 10.7MHz and heterodyne signal of 133MHz are mixed to obtain a 144MHz frequency which is power amplified to 8W of rated output.

In the receiving section, the receive frequency of 144MHz band and the heterodyne frequency of 133MHz band are mixed to obtain 10.7MHz IF frequency.

The IF frequency is combined with a carrier and is fed to the detector circuit through the crystal filter for SSB detection, thus AF signal being obtained.

Both the transmitting section and the receiving section are provided with various auxiliary circuits and connecting terminals to ensure maximum performance and reliable operation.

Auxiliary Circuits:

1. S/RF meter
2. Noise blanker circuit
3. Amplification type AGC
4. Amplification type ALC
5. RIT circuit
6. VXO circuit
7. ON AIR indicator circuit
8. Final stage protection
9. CW circuit
10. Transmitting/receiving antenna, diode selector circuit
11. RF gain control
12. Frequency synthesizer
13. Additional channels

Auxiliary Terminals:

1. ANT
2. EXT SP
3. EXT VFO
4. KEY
5. DC
6. MIC

1. Synthesizer Unit (X50-1240-00)

The 41MHz band crystal is oscillated (3rd overtone) by Q5 (2SC460 (B)), and the oscillated frequency is tripled by Q6 (2SC460(B)) to produce 124.9MHz band signal. D19 (1S2208) is connected between Q5 and the crystal to enable the frequencies for both the transmitter and receiver to be varied by the VXO volume control.

The 8MHz band crystal is oscillated by Q10 (2SC460(B)), and the oscillated frequency is amplified through the buffer amplifier, which, together with the above 124.9MHz band signal, is fed to the balanced mixer circuit composed of Q7 and Q8 (2SK19 (GR)). The frequency of the 8MHz band crystal can be selected either to 144.1MHz or 144.2MHz band by means of the BAND selector switch. When the switch is set to 144.2MHz band, the indicator (light emission diode: D102) will be illuminated. The oscillator circuit can be added a variable capacitance diode (D20) for RIT control, thus the receiving frequency can be varied by setting the RIT switch to ON during receive mode.

The balanced mixer circuit is balanced by VR1 (1k Ω). When the circuit is under perfectly balanced condition, each signal being fed is mixed and, therefore, they do not appear on the output circuit. Consequently, the 133.4MHz signal produced by the balanced mixer circuit has less spurious component. Since this signal passes through B.P.F. composed of 4 coils, the injected signal of ± 8 MHz is further suppressed. The signal passing through B.P.F. is amplified by Q9 (3SK41(L, M)) and is then fed to the transmit or receive mixer circuit through the diode switch, as a heterodyne frequency.

In the transmitting mode, the light emission diode (D101) in the ON AIR indicator is illuminated while the 133.4MHz signal is fed to the balanced mixer circuit consisting of Q14 and Q15 (2SK19(GR)), together with the 10.7MHz IF signal which is amplified by Q13 (3SK35 (GR, BL)) after passing through the SSB filter. This signal is then heterodyned to 144MHz, passes through B.P.F. and HF amplified by Q16 (3SK41(L, M)) and Q17 (2SC998) so that it is fed to the driver of the final unit.

The bias of IF amplifier (Q13) and HF amplifier (Q16) are controlled by ALC.

In the receiving mode, the supply voltage of AF power amplifier (Q2, Q3) is turned to ON, thereby the AF signal amplified by Q18 and Q1 is further amplified to drive the speaker.

2. Final Unit (X45-1040-00)

The 144MHz input signal is amplified by the driver Q1 (2SC1169) and power amplified by Q2 (2SC1242A) to the rated output of more than 8W. The amplifier used is of AB1 class to improve the

CIRCUIT DESCRIPTION

linearity; the base circuit is biased by 9V of stabilized voltage while the drive stage employs Q3 (2SD235 (Y, O)) for stability of power supply. The output passes through the π matched circuit and the low pass filter in the filter unit, thus reducing the spurious radiation.

3. Filter Unit (X51-1110-00)

The filter unit is composed of the diode type antenna selector circuit, filter circuit, protection circuit, ALC detector and amplifier circuit, and the control unit with RF meter signal detector circuit.

In the ALC circuitry, the transmit output is detected by D4 and D5, passes through the control volume VR3 and is ALC amplified by Q1 (2SC733) to control the amplifier circuit (Q13, Q16) of the synthesizer unit.

The protection circuit detects the reflection wave by the SWR detector circuit when the load becomes abnormal during transmit mode; it is detected by D6 and the DC component is fed to the protection switching circuit (Q8) of the carrier unit.

4. Carrier Unit (X50-1230-00)

The 10.6985MHz crystal is oscillated by Q5 and the oscillated signal is used as a carrier for transmission and reception.

In the SSB transmitting mode, the 10.6985MHz carrier signal is fed to the balanced modulator circuit (D1 ~ D4), together with the audio signal amplified by Q1, Q2 and Q3, producing DSB of 10.7MHz band. Since this circuit is a balanced circuit, the 10.6985MHz signal is suppressed and DSB output appears at the output side only when the audio signal is added to it.

The DSB signal thus produced passes through the buffer circuit (Q4) and the 10.7MHz crystal filter, and is then converted into SSB signal of USB so that it is applied to the IF amplifier (Q13) of the synthesizer unit.

In the CW MODE, the 10.6985MHz signal is shifted by D8 (1S2208) to 10.6993MHz while also it is unbalanced by adding a DC voltage through S203 to the balanced circuit, to produce a carrier for keying the emitter of Q4.

Q8 is used as a protection switch, controlling the buffer circuit (Q4) by the DC component after the reflection wave from the final unit is detected.

Q7 is a DC-DC oscillator circuit. The 400Hz signal oscillated from this circuit is rectified by D10 ~ D13, which passes through D14 to produce -6V of voltage. This voltage is supplied to the AGC amplifier (Q13) of the RX unit. The voltage shunted by R30 is applied to the IF amplifier (Q5) through the RB terminal on the RX unit.

5. RX Unit (X55-1080-00)

The 144MHz band signal selected by the diode switch is applied to the gate of Q1 (3SK41) from L1 and L2, and is RF amplified. The helical tuning circuit provided between the RF stage and the mixer stage is used to attenuate the signal waves outside the band. The 144MHz band signal picked up from the helical circuit is fed to the mixer circuit (Q2), together with the 133.4MHz signal premixed in the synthesizer unit. In this manner, the 10.7MHz output taken from L6 and L7 is amplified through the IF amplifier.

The IF signal passing through the 10.7MHz SSB crystal filter is further amplified by Q5 and Q14 and is applied to the balanced detector circuit composed of D16 ~ D19 including the secondary side of L22. At the same time, the signal from the carrier unit is fed to the circuit through the CAR terminal so that it is picked up as AF signal which is amplified by the AF amplifier (Q15) after passing through the filter.

The NB circuit takes IF signal from Q3 and controls D1 when the NB switch is turned to ON, reducing pulse noise such as ignition noise.

The amplification type AGC circuit takes IF signal from Q14. This signal is amplified by Q12 and Q13 to control the levels of Q1, Q5 and Q14 with the use of the RF gain volume control, thus the cross modulation is suppressed and distortionless sound is obtained.

The S meter circuit is used to amplify the AGC variation factor through Q6 and Q7. The amplified signal passes through switching diode D8 to activate the S meter.

PARTS ALIGNMENT

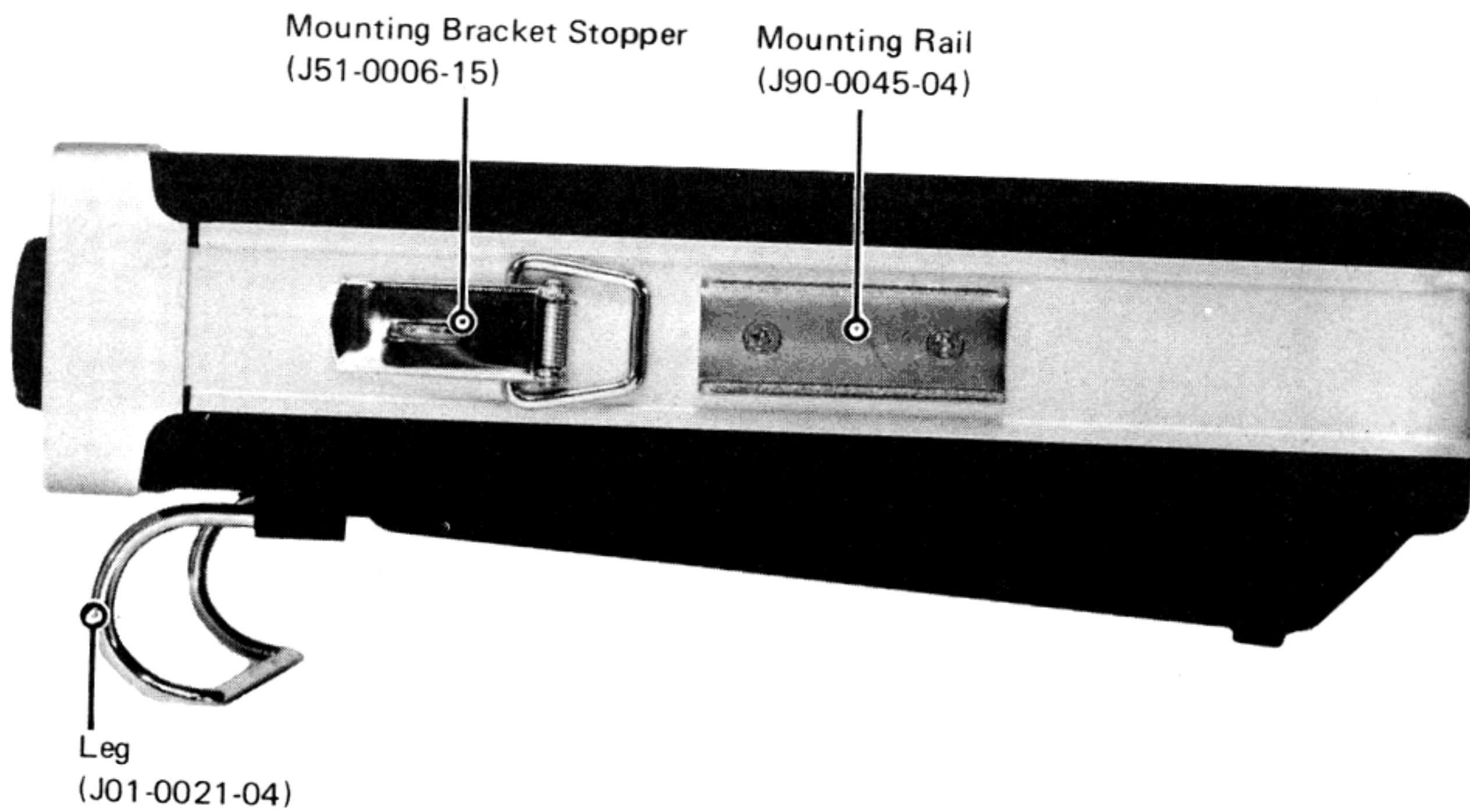
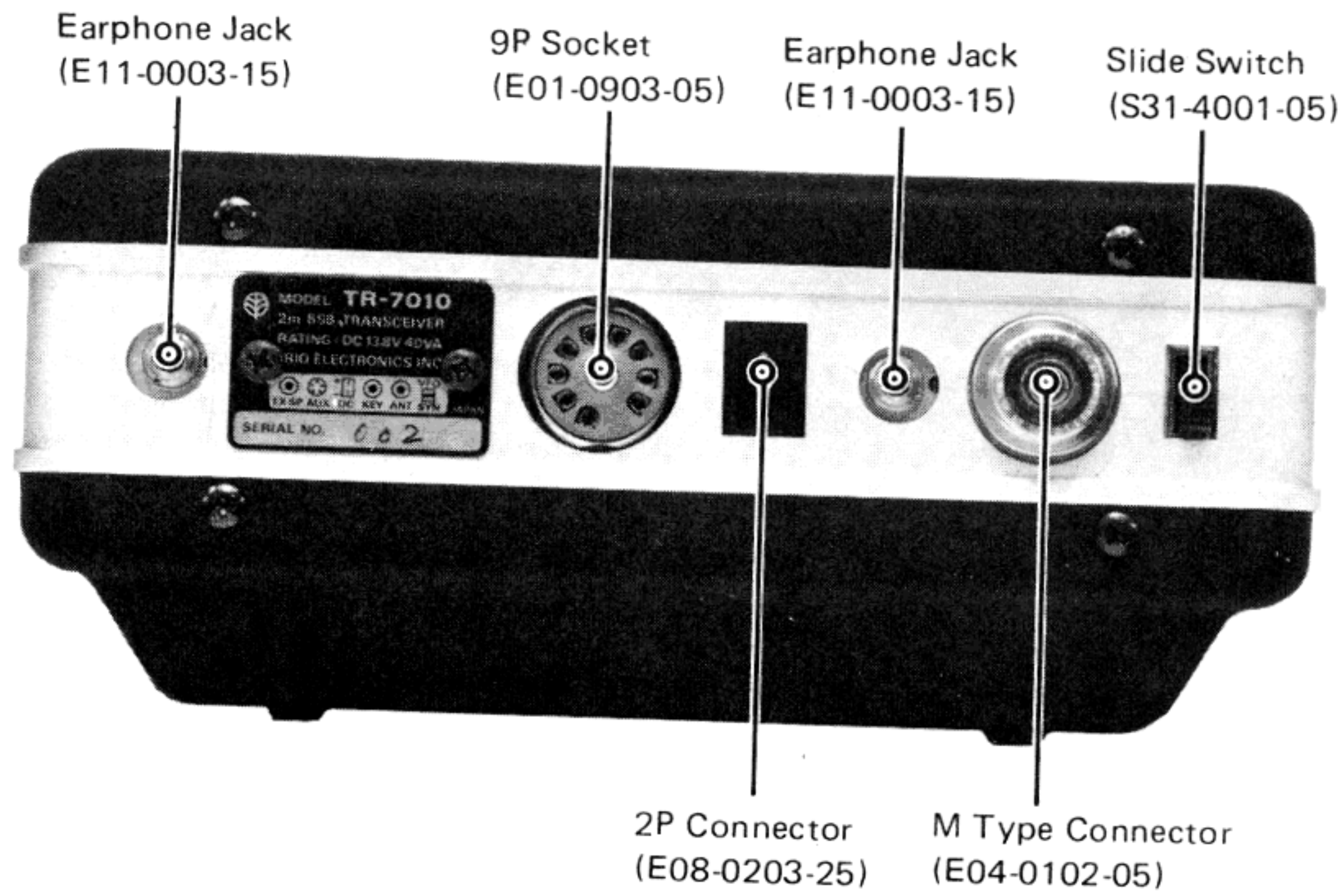
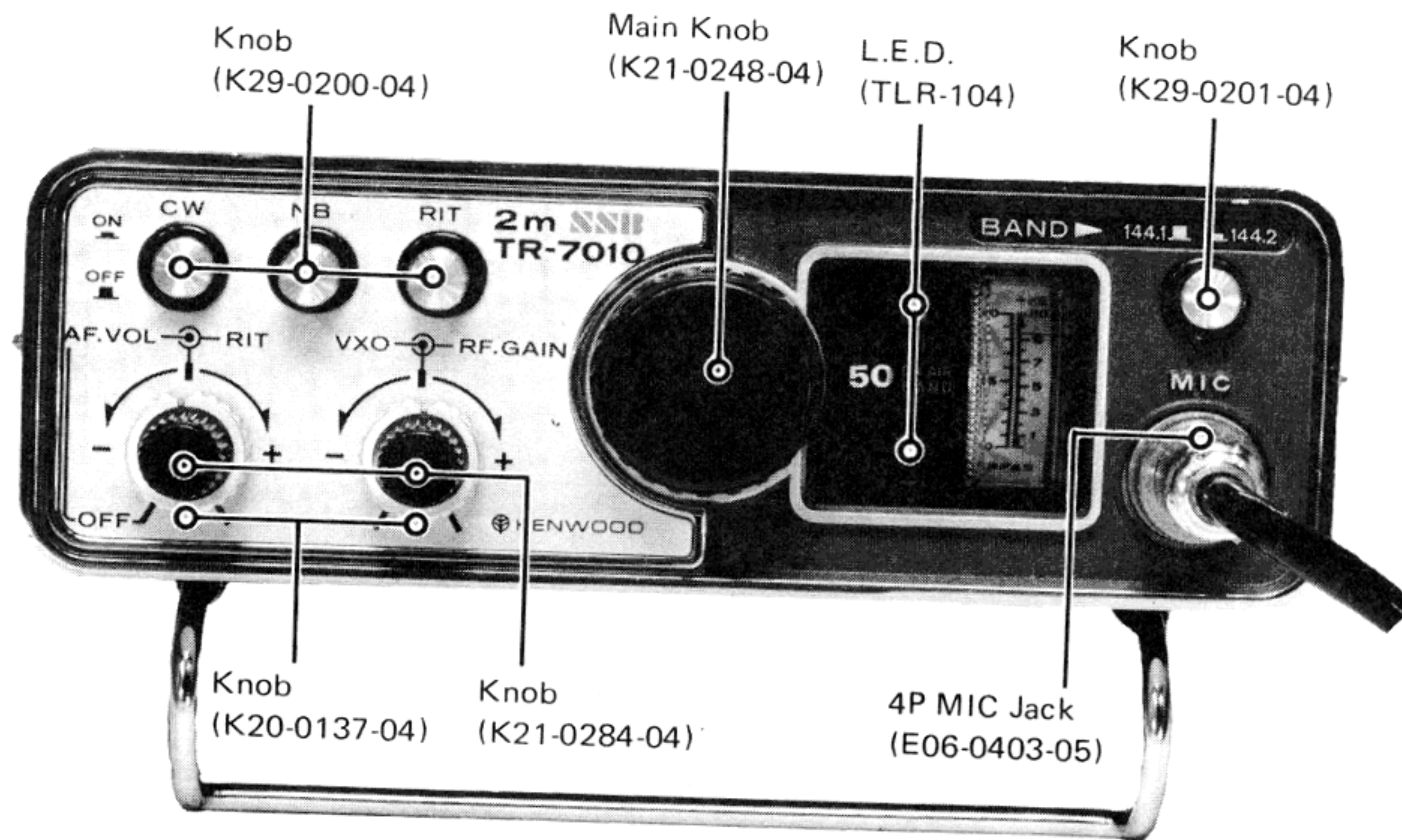

PARTS ALIGNMENT

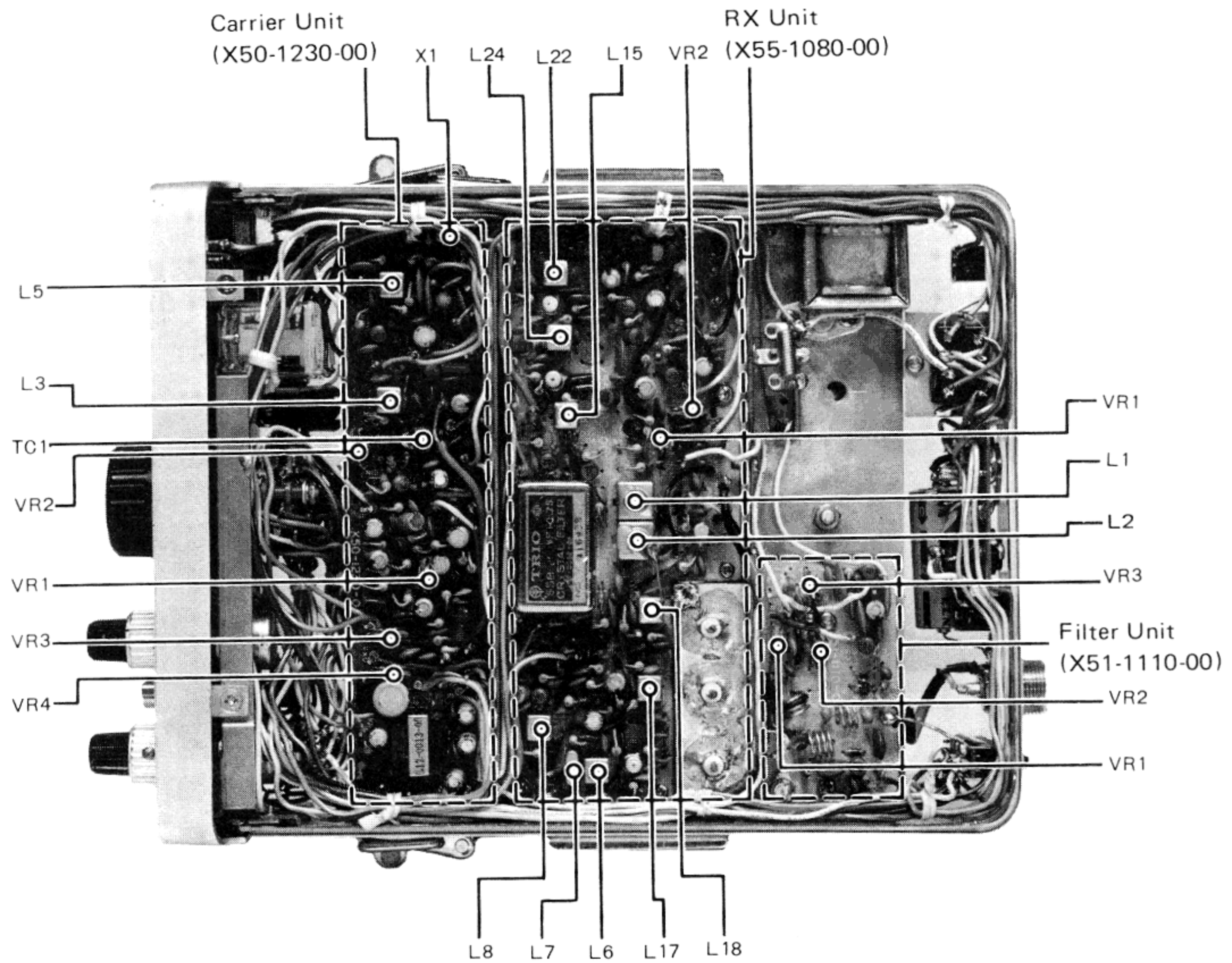
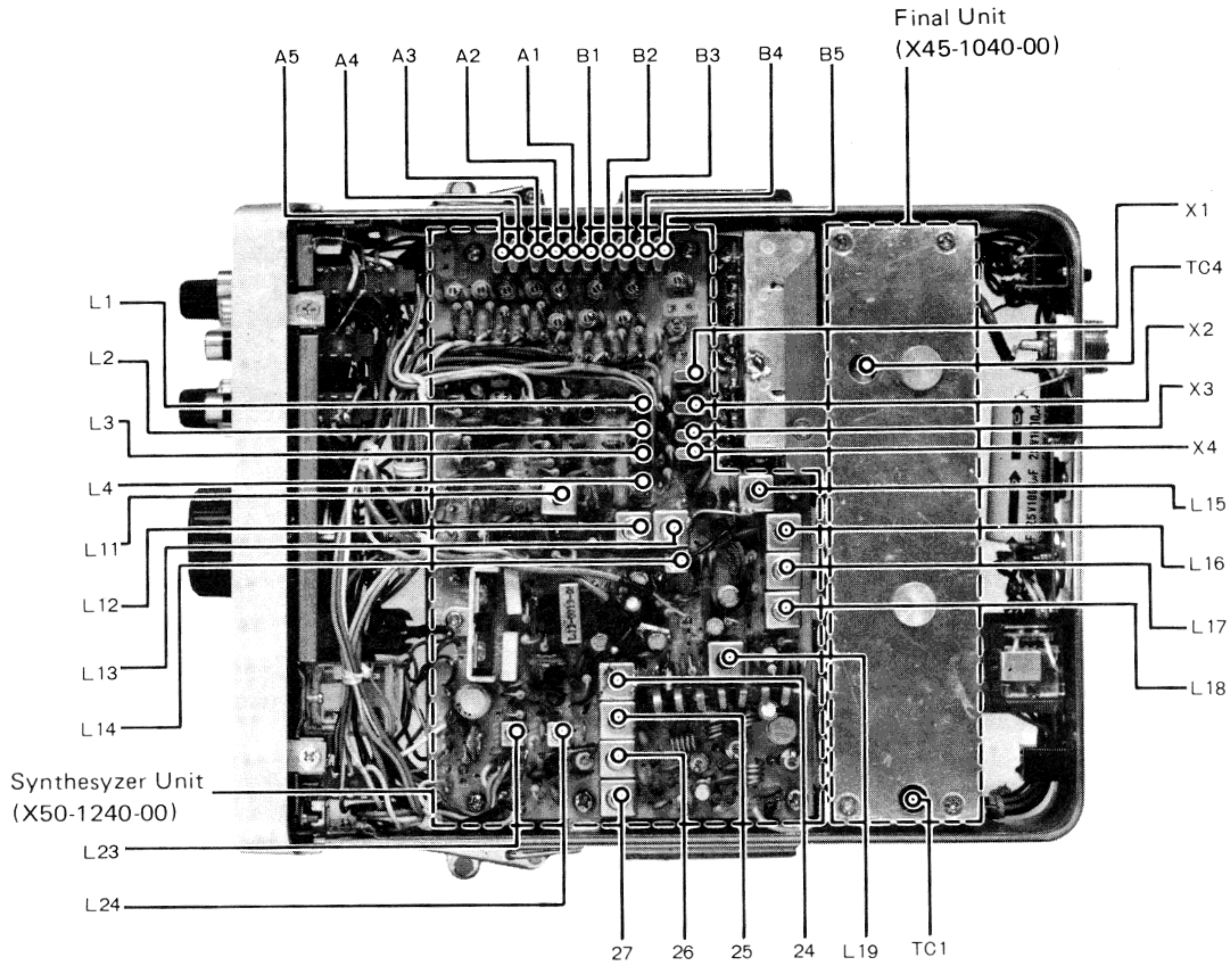

PC BOARD

SYNTHESIZER UNIT (X50-1240-00)

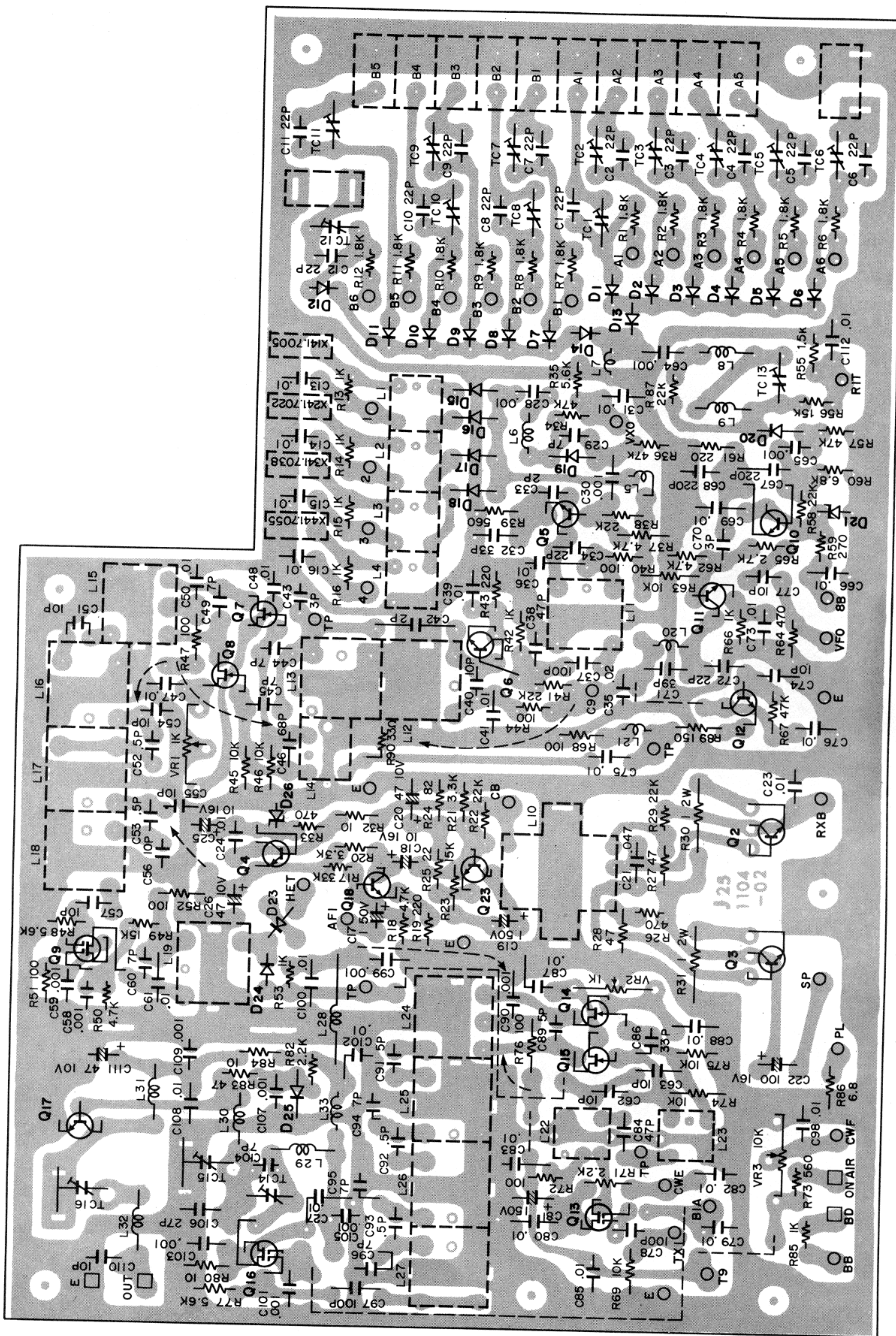

- Q1: 2SC734 (Y)
- Q18: 2SC733 (Y)
- Q2, 3: 2SD235 (Y, O)
- Q4: 2SC496 (Y, O)
- Q5, 6, 10-12: 2SC460 (B)
- Q7, 8, 14, 15: 2SK19 (GR)
- Q17: 2SC998
- Q9, 16: 3SK41 (L, M)
- Q13: 3SK35 (GR, BL)
- D1-18, 25: 1S1555
- D19: 1S2208
- D20: 1S1658-1
- D21-26: WZ.090
- D23, 24: 1S73A
- Q1: 2SC734 (Y)
- Q18: 2SC733 (Y)
- Q2, 3: 2SD235 (Y, O)
- Q4: 2SC496 (Y, O)
- Q5, 6, 10-12: 2SC460 (B)
- Q7, 8, 14, 15: 2SK19 (GR)
- Q17: 2SC998
- Q9, 16: 3SK41 (L, M)
- Q13: 3SK35 (GR, BL)
- D1-18, 25: 1S1555
- D19: 1S2208
- D20: 1S1658-1
- D21-26: WZ.090
- D23, 24: 1S73A

PC BOARD

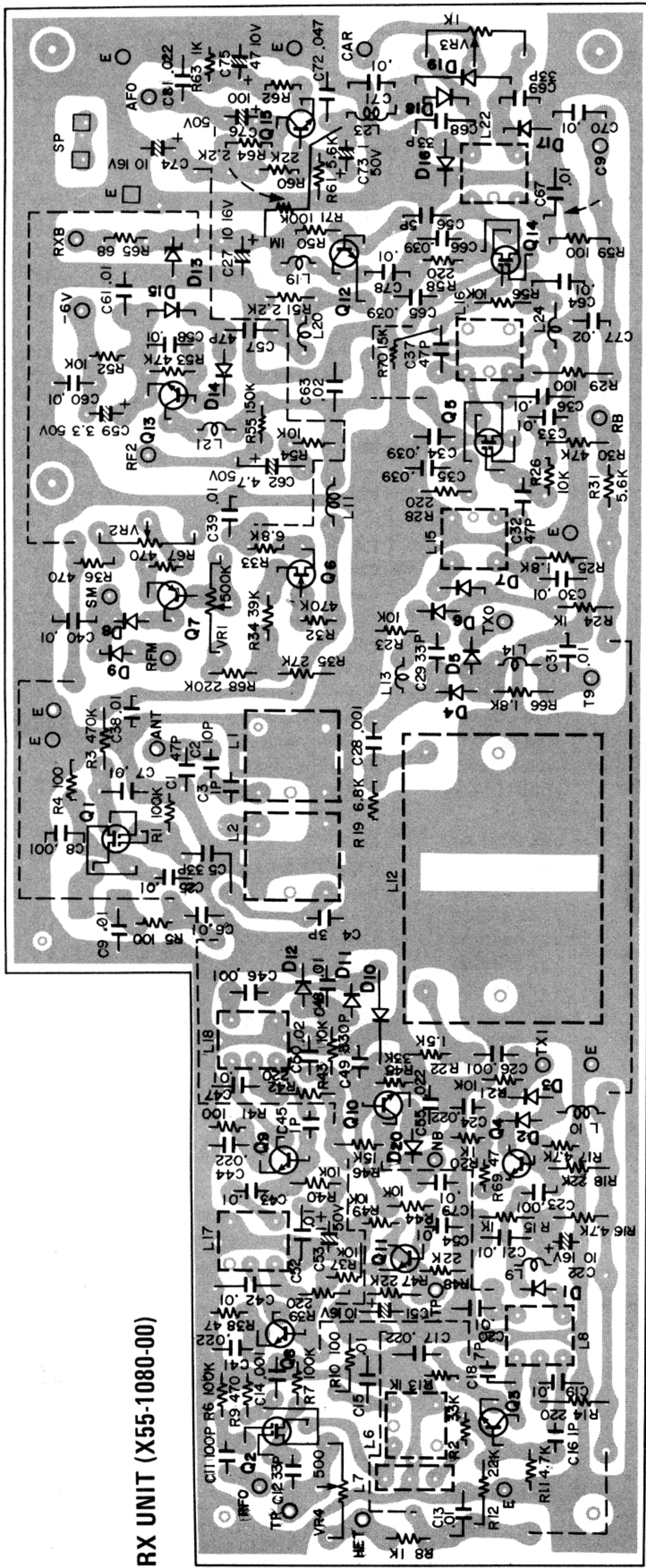

▼ RX UNIT (X55-1080-00)

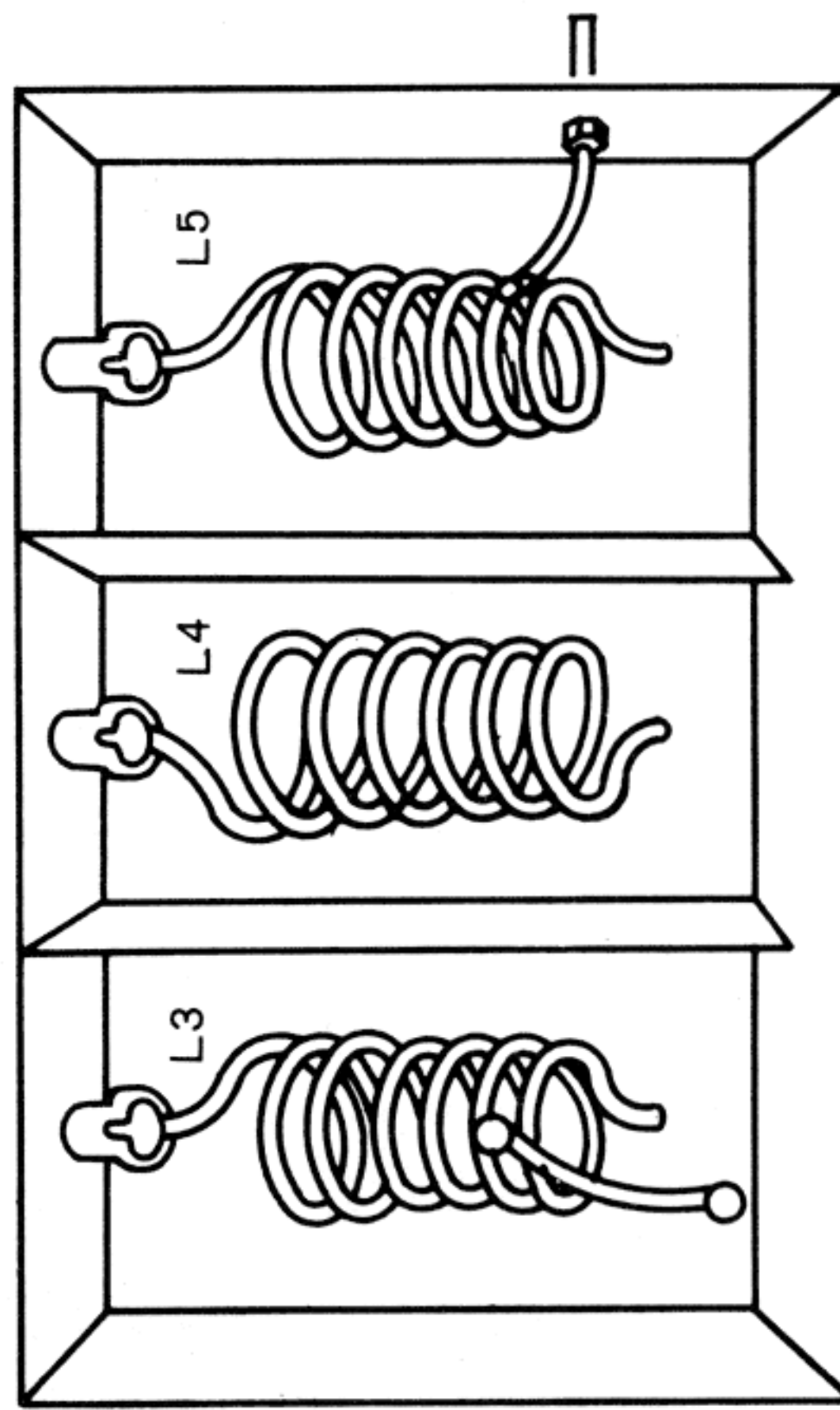

TC1 TC2 TC3

- D1~7: 1S73A.
- D8~11, 14~20: 1N60
- D12: 1S1555
- D13: WZ 090

- Q7: 2SA495 (Y, O)
- Q10, 11, 13: 2SC733 (Y, O)

- Q3, 4, 9: 2SC460 (B)
- Q12: 2SC458 (B)

- Q1: 3SK41 (L)
- Q2, 5, 14: 3SK35 (GR)

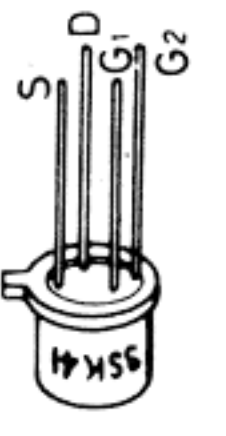

▼ FILTER UNIT (X51-1110-00)

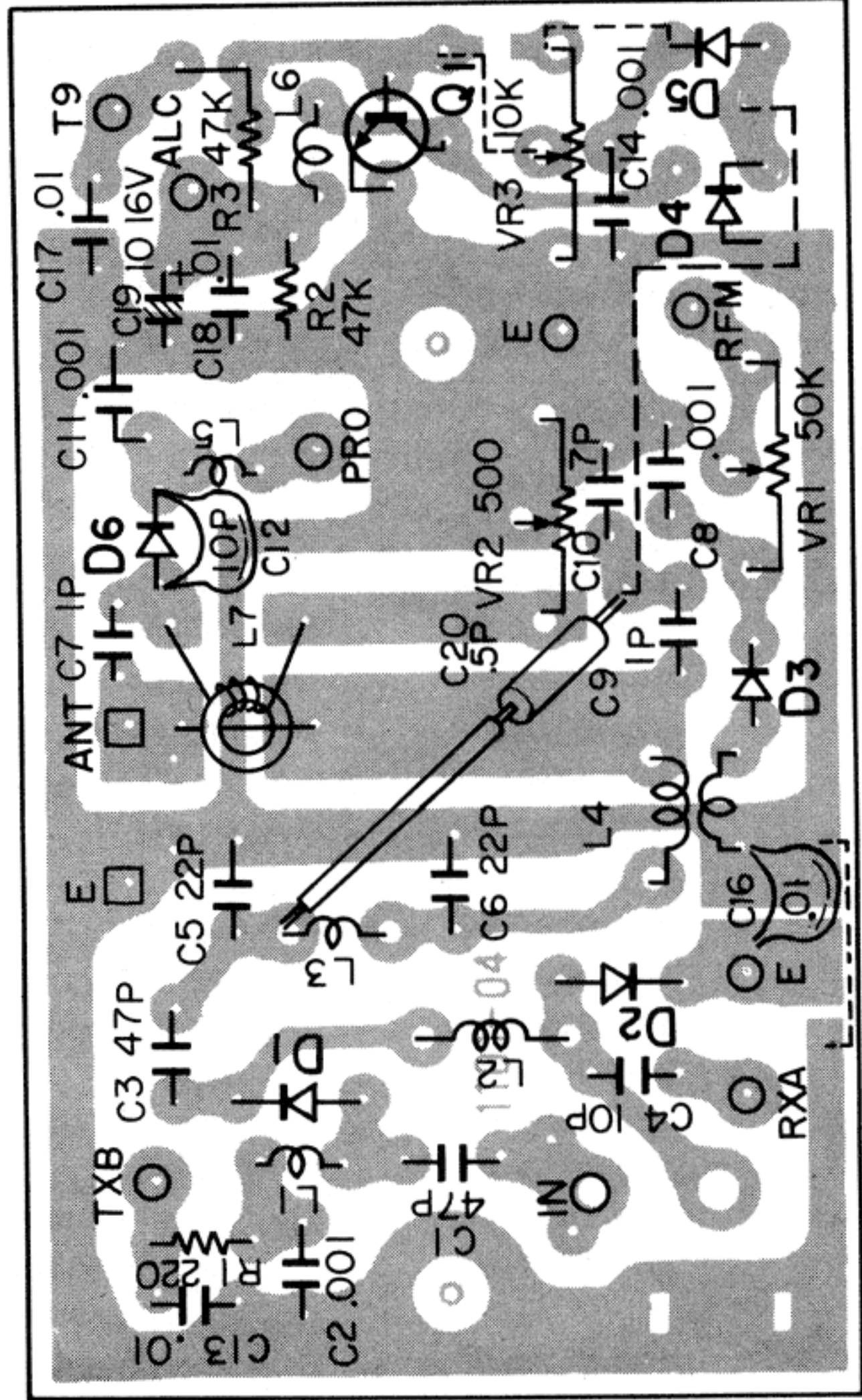

- Q1: 2SC733 (Y) or (O)



- D1, 2: M1301
- D3 ~ 6: 1N60

PARTS LIST

061: For Europe except for England

051: Only for England

Ref. No.	Parts No.	Description	Re- marks
CAPACITOR			
C101	CE02W1E102	Electrolytic 1000 μ F 25WV	
C102~ 105	CK45F1H103Z	Ceramic 0.01 μ F +80%, -20%	
C106	CK45D1H102M	Ceramic 0.001 μ F \pm 20%	
C107	CK45F1H103Z	Ceramic 0.01 μ F +80%, -20%	
C108	CC45SL2H150J	Ceramic 15pF \pm 5%	
C109	CK45F1H103Z	Ceramic 0.01 μ F +80%, -20%	
C110	CC45SL1H101K	Ceramic 100pF \pm 20%	
C111	CK45F1H103Z	Ceramic 0.01 μ F +80%, -20%	
RESISTOR			
R101	PD14BY2E472J	Carbon 4.7k Ω \pm 5%	
SEMICONDUCTOR			
D101,102	V11-0304-05	L.E. Diode TLR-104	
D103	V11-0076-05	Diode 1S1555	
POTENTIOMETER			
VR101, 102	R06-9004-05	5k Ω (A) AF(with power switch) 10k Ω (B) RIT.	
VR201, 202	R06-3007-05	10k Ω (B) RF GAIN, 10k Ω (B) V X O	
SWITCH/RELAY			
S1	S01-2027-05	Rotary switch	
S2~4	S40-3007-05	Push switch	
S5	S40-2039-05	Push switch	
S6	S31-4001-05	Slide switch	
RL1	S51-2002-05	Relay	
COIL			
L101	L15-0001-05	Choke coil (low frequency)	
L102	L33-0074-05	Choke coil 0.022 μ H	
MISCELLANEOUS			
-	A01-0174-02	Case (B)	
-	A01-0175-02	Case (C)	
-	A10-0401-02	Chassis	
-	A20-0810-05	Panel	
-	A21-0181-04	Dressing panel	051
-	A21-0201-04	Dressing panel	061
-	A22-0160-03	Subpanel	
-	A30-0091-04	Dial board	
-	B01-0090-03	Escutcheon	
-	B03-0071-14	Dial mask	
-	B05-0163-14	Speaker grille cloth	
-	B10-0164-04	Front glass	
PL1	B30-0002-05	Pilot lamp (12V, 3W)	
-	B31-0194-05	S meter	
-	B40-1021-04	Model name plate	
-	B42-0540-04	Dressing name plate (Band indication)	
-	B50-1290-00	Operating manual	061
-	B50-1369-00	Operating manual	051
-	D32-0010-04	Relay stopper	
-	E01-0903-05	9P socket (jack)	
-	E04-0102-05	M type connector	
-	E05-0901-05	9P socket (plug)	
-	E06-0403-05	4P mic jack	
-	E08-0203-25	2P connector (jack)	
-	E09-0203-25	2P connector (plug)	
-	E11-0003-15	Earphone jack x 2	
-	E12-0001-05	Phone plug	
-	E15-0038-05	PL socket	
-	E18-0801-05	Relay socket	
-	E22-0216-05	Lug board	
-	E29-0046-04	Repeating hardware x 2	
-	E30-0234-15	Wire (for TX)	
-	E30-0355-05	Wire (for speaker)	
-	F05-4022-05	Fuse x 2	
-	F07-0312-04	Shield cover	
-	F10-0346-04	Shield plate (A)	
-	F10-0351-04	Shield plate (B)	
-	F15-0128-04	Shading plate x 2	
-	G13-0014-04	Cushion	
-	H01-1250-03	Case	051
-	H01-1264-03	Case	061
-	H03-0373-04	Carton case (external)	051
-	H03-0381-04	Carton case (external)	061
-	H10-1204-12	Polystyrene foamed fixture	
-	H10-1205-04	Polystyrene foamed plate	
-	H10-1206-14	Buffer fixture	
-	H25-0049-03	Polyethylene bag	
-	H25-0079-04	Polyethylene bag	
-	H25-0103-03	Polyethylene bag	
-	H25-0106-04	Polyethylene bag	
-	J01-0021-04	Leg	
-	J02-0058-04	Leg (rubber) x 2	
-	J13-0029-05	Fuse holder	
-	J19-0356-05	Diode holder x 2	
-	J21-0448-04	Speaker mounting fitting x 3	
-	J21-0941-02	Angle	
-	J32-0146-04	Hexagonal boss x 4	
-	J41-0020-04	Knob bushing x 4	
-	J51-0006-15	Mounting bracket stopper x 2	
-	J61-0019-05	Cable wrapping band x 12	
-	J29-0045-04	Mounting bracket guide x 2	
-	K20-0137-04	Knob (outside) x 2	
-	K21-0248-04	Main knob	
-	K21-0284-04	Knob (inside) x 2	
-	K29-0200-04	Knob (black) x 3	
-	K29-0201-04	Knob (red)	
-	T03-0027-15	Speaker	
-	T91-0024-05	Microphone (TRIO)	051
-	T91-0026-05	Microphone (Kenwood)	061
-	X45-1040-00	Final unit	
-	X50-1230-00	Carrier unit	
-	X50-1240-00	Synthesizer unit	
-	X51-1110-00	Filter unit	
-	X55-1080-00	RX unit	

PARTS LIST

■ FINAL (X45-1040-00)

Ref. No.	Parts No.	Description	Re- marks
CAPACITOR			
C1	CC45SL2H070D	Ceramic 7pF ±0.5pF	
C2	CC45SL2H150J	Ceramic 15pF ±5%	
C4	CK18E2H102P	Ceramic 0.001μF +100%, -0%	
C6	CK45F1H103Z	Ceramic 0.01μF +80%, -20%	
C7	CK18E2H102P	Ceramic 0.001μF +100%, -0%	
C8	CC45SL2H220J	Ceramic 22pF ±5%	
C9	CC45SL2H470J	Ceramic 47pF ±5%	
C10	C90-0215-05	Ceramic 100pF ±10%	
C11	CE04W1E100(RL)	Electrolytic 10μF 25WV	
C12	CK45D1H102M	Ceramic 0.001μF ±20%	
C13	CC45SL2H100J	Ceramic 10pF ±5%	
C14	CE04W1A470(RL)	Electrolytic 47μF 10WV	
C15	CK45D1H102M	Ceramic 0.001μF ±20%	
RESISTOR			
R1	PD14BY2E470J	Carbon 47Ω ±5% 1/4W	
R2	PD14BY2E331J	Carbon 330Ω ±5% 1/4W	
R4	RC05GF2H221J	Carbon 220Ω ±5% 1/2W	
R5	RC05GF2H121J	Carbon 120Ω ±5% 1/2W	
R6	RC05GF2H100J	Carbon 10Ω ±5% 1/2W	
R7	PD14BY2E101J	Carbon 100Ω ±5% 1/4W	
SEMICONDUCTOR			
Q1	V03-0350-05	Transistor 2SC1169	
Q2	V03-0349-05	Transistor 2SC1242A	
Q3	V04-0046-05	Transistor 2SD235 (Y) or (O)	
D1, 2	V11-0076-05	Diode 1S1555	
D3	V11-0249-05	Zener diode WZ-120	
COIL			
L1	L34-0426-05	VHF coil	
L2	L34-0005-05	VHF coil	
L3	L34-0427-05	VHF coil	
L4	L34-0411-05	VHF coil	
L5	L34-0426-05	VHF coil	
TRIMMER			
TC1, 2	C05-0013-15	Ceramic trimmer 20pF x 2	
TC3	C05-0001-05	Trimmer 20pF	
TC4	C05-0002-05	Trimmer 40pF	
MISCELLANEOUS			
-	E23-0015-04	Earth lug x 2	
-	E23-0048-04	Terminal	
-	E23-0072-04	Terminal (earth)	
-	F01-0158-03	Heat sink	
-	F20-0028-05	Shield plate (for 2SD235)	
-	J25-0916-03	PC board	
-	J32-0029-04	Hexagonal boss	

■ CARRIER (X50-1230-00)

Ref. No.	Parts No.	Description	Re- marks
CAPACITOR			
C1, 2	CK45F1H103Z	Ceramic 0.01μF +80%, -20%	
C3	CQ93M1H104K	Mylar 0.1μF ±10%	
C4	CK45D1H102M	Ceramic 0.001μF ±20%	
C5	CE04W1C100(RL)	Electrolytic 10μF 16WV	
C6	CE04W1A470(RL)	Electrolytic 47μF 10WV	
C7	CE04W1H010(RL)	Electrolytic 1μF 50WV	
C8, 9	CQ92M1H223K	Mylar 0.022μF ±10%	
C10	CE04W1H010(RL)	Electrolytic 1μF 50WV	
C11	CE04W1C100(RL)	Electrolytic 10μF 16WV	
C12	CE04W1H010(RL)	Electrolytic 1μF 50WV	
C13	CK45F1H103Z	Ceramic 0.01μF +80%, -20%	
C14, 15	CK45D1H102M	Ceramic 0.001μF ±20%	
C16	CC45CH1H470J	Ceramic 47pF ±5%	
C17	CC45SL1H100J	Ceramic 10pF ±5%	
C18	CE04W1A470(RL)	Electrolytic 47μF 10WV	
C19, 20	CK45F1H103Z	Ceramic 0.01μF +80%, -20%	
C21	CK45D1H102M	Ceramic 0.001μF ±20%	
C22, 23	CC45SL1H221K	Ceramic 220pF ±10%	
C24, 25	CK45F1H103Z	Ceramic 0.01μF +80%, -20%	
C26	CE04W1C101(RL)	Electrolytic 100μF 16WV	
C27	CC45CH1H050D	Ceramic 5pF ±0.5pF	
C28	CC45CH1H330J	Ceramic 33pF ±5%	
C29	CK45F1H103Z	Ceramic 0.01μF +80%, -20%	
C30	CC45SL1H470J	Ceramic 47pF ±5%	
C31	CC45SL1H101K	Ceramic 100pF ±10%	
C32, 33	CK45F1H103Z	Ceramic 0.01μF +80%, -20%	
C34	CE04W1HR47(RL)	Electrolytic 0.47μF 50WV	
C35	CK45F1H103Z	Ceramic 0.01μF +80%, -20%	
C36 ~ 39	CE04W1C100(RL)	Electrolytic 10μF 16WV	
C41	CE04W1A470(RL)	Electrolytic 47μF 10WV	
C42	CK45F1H103Z	Ceramic 0.01μF +80%, -30%	
C43	CE04W1C100(RL)	Electrolytic 10μF 16WV	
C44	CK45F1H103Z	Ceramic 0.01μF +80%, -20%	
C46	CC45CH1H050D	Ceramic 5pF ±0.5pF	
RESISTOR			
R1	RD14CY2E472J	Carbon 4.7kΩ ±5% 1/4W	
R2	PD14CY2E223J	Carbon 22kΩ ±5% 1/4W	
R3	PD14CY2E102J	Carbon 1kΩ ±5% 1/4W	
R4	PD14CY2E101J	Carbon 100Ω ±5% 1/4W	
R5	PD14CY2E222J	Carbon 2.2kΩ ±5% 1/4W	
R6	PD14CY2E102J	Carbon 1kΩ ±5% 1/4W	
R7	PD14CY2E154J	Carbon 150kΩ ±5% 1/4W	
R8	PD14CY2E221J	Carbon 220Ω ±5% 1/4W	
R9, 10	PD14CY2E223J	Carbon 22kΩ ±5% 1/4W	
R11	PD14CY2E331J	Carbon 330Ω ±5% 1/4W	
R12	PD14CY2E102J	Carbon 1kΩ ±5% 1/4W	
R13	PD14CY2E103J	Carbon 10kΩ ±5% 1/4W	
R14, 15	PD14CY2E101J	Carbon 100Ω ±5% 1/4W	
R16	PD14CY2E103J	Carbon 10kΩ ±5% 1/4W	
R17	PD14CY2E221J	Carbon 220Ω ±5% 1/4W	
R18, 19	PD14CY2E473J	Carbon 47kΩ ±5% 1/4W	
R20	PD14CY2E393J	Carbon 39kΩ ±5% 1/4W	
R21	PD14CY2E103J	Carbon 10kΩ ±5% 1/4W	
R22	PD14CY2E182J	Carbon 1.8kΩ ±5% 1/4W	
R23	PD14CY2E101J	Carbon 100Ω ±5% 1/4W	
R24	PD14CY2E823J	Carbon 82kΩ ±5% 1/4W	
R25	PD14CY2E101J	Carbon 100Ω ±5% 1/4W	
R26	PD14CY2E152J	Carbon 1.5kΩ ±5% 1/4W	

PARTS LIST

Ref. No.	Parts No.	Description	Re- marks
R27	PD14CY2E223J	Carbon 22kΩ ±5% 1/4W	
R28	PD14CY2E472J	Carbon 4.7kΩ ±5% 1/4W	
R29	PD14CY2E471J	Carbon 470Ω ±5% 1/4W	
R30	PD14CY2E472J	Carbon 4.7kΩ ±5% 1/4W	
R31, 32	PD14CY2E103J	Carbon 10kΩ ±5% 1/4W	
R33	PD14CY2E471J	Carbon 470Ω ±5% 1/4W	
R34	PC05GF2H100J	Carbon 10Ω ±5% 1/4W	
R35	PD14CY2E331J	Carbon 330Ω ±5% 1/4W	
R36	PD14CY2E152J	Carbon 1.5kΩ ±5% 1/4W	
R37	PD14CY2E223J	Carbon 22kΩ ±5% 1/4W	
R38	PD14CY2E473J	Carbon 47kΩ ±5% 1/4W	
R39	PD14CY2E223J	Carbon 22kΩ ±5% 1/4W	
SEMICONDUCTOR			
Q1~3	V03-0129-05	Transistor 2SC733 (Y)	
Q4	V03-0134-05	Transistor 2SC371 (O)	
Q5	V03-0079-05	Transistor 2SC460 (B)	
Q6	V03-0134-05	Transistor 2SC371 (O)	
Q7	V03-0241-05	Transistor 2SC735 (Y, O)	
Q8	V03-0123-05	Transistor 2SC733 (Y, O)	
Q9	V03-0336-05	Transistor 2SC496 (Y, O)	
D1~4	V11-0051-05	Diode 1N60	
D5	V11-0076-05	Diode 1S1555	
D6, 7		Diode 1S1587	
D8	V11-0317-05	Diode 1S2208 or 1S2206	
D9	V11-0270-05	Diode U05B	
D10~13	V11-0076-05	Diode 1S1555	
D14	V11-0243-05	Zener diode WZ-061	
D15	V11-0240-05	Zener diode WZ-090	
POTENTIOMETER			
VR1	R12-2015-05	Volume 5kΩ	
VR2	R12-0048-05	Volume 100Ω	
VR3, 4	R12-3025-05	Volume 10kΩ	
VR5	R12-2015-05	Volume 5kΩ	
COIL/TRIMMER			
L1, 2	L40-1021-03	Ferri-inductor 1mH	
L3	L30-0005-05	IFT	
L4	L40-1021-03	Ferri-inductor 1mH	
L5	L30-0281-05	IFT	
L6, 7	L40-1021-03	Ferri-inductor 1mH	
L8	L12-0013-05	Input transformer	
TC1, 2	C05-0013-15	Trimmer 20pF	
X'tal			
X1	L77-0355-05	Crystal oscillator 10.6985 MHz	
MISCELLANEOUS			
-	E23-0047-04	Terminal	
-	F10-0348-14	Shield plate	
-	J25-1102-13	PC board	

■ SYNTHESIZER (X50-1240-00)

Ref. No.	Parts No.	Description	Re- marks
CAPACITOR			
C1~12	CC45SL1H220J	Ceramic 22pF ±5%	
C13~16	CK45F1H103Z	Ceramic 0.01μF +80%, -20%	
C17	CE04W1H010(RL)	Electrolytic 1μF 50WV	
C18	CE04W1C100(RL)	Electrolytic 10μF 16WV	
C19	CE04W1H010(RL)	Electrolytic 1μF 50WV	
C20	CE04W1A470(RL)	Electrolytic 47μF 10WV	
C21	CQ92M1H473K	Mylar 0.047μF ±10%	
C22	CE04W1C101(RL)	Electrolytic 100μF 16WV	
C23, 24	CK45F1H103Z	Ceramic 0.01μF +80%, -20%	
C25	CE04W1C100(RL)	Electrolytic 10μF 16WV	
C26	CE04W1A470(RL)	Electrolytic 47μF 10WV	
C27	CK45F1H103Z	Ceramic 0.01μF +80%, -20%	
C28	CK45D1H102M	Ceramic 0.001μF ±20%	
C29	CC45CH1H070D	Ceramic 7pF ±0.5pF	
C30	CK45D1H102M	Ceramic 0.001μF ±20%	
C31	CK45F1H103Z	Ceramic 0.01μF +80%, -20%	
C32	CC45CH1H330J	Ceramic 33pF ±5%	
C33	CC45CH1H020C	Ceramic 2pF ±0.25pF	
C34	CC45TH1H220J	Ceramic 22pF ±5%	
C35	CK45F1H203Z	Ceramic 0.02μF +80%, -20%	
C36	CK45F1H103Z	Ceramic 0.01μF +80%, -20%	
C37	CC45SL1H101J	Ceramic 100pF ±5%	
C38	CC45SL1H470J	Ceramic 47pF ±5%	
C39	CK45F1H103Z	Ceramic 0.01μF +80%, -20%	
C40	CC45CH1H100J	Ceramic 10pF ±5%	
C41	CK45F1H103J	Ceramic 0.01μF +80%, -20%	
C42	CC45SL1H020C	Ceramic 2pF ±0.25pF	
C43	CC45CH1H030C	Ceramic 3pF ±0.25pF	
C44, 45	CC45CH1H070D	Ceramic 7pF ±0.5pF	
C46	CC45CH1H680J	Ceramic 68pF ±5%	
C47, 48	CK45F1H103Z	Ceramic 0.01μF +80%, -20%	
C49	CC45CH1H070D	Ceramic 7pF ±0.5pF	
C50	CK45F1H103Z	Ceramic 0.01μF +80%, -20%	
C51	CC45CH1H100J	Ceramic 10pF ±5%	
C52, 53	C90-0231-05	Ceramic 0.5pF	
C54~57	CC45CH1H100J	Ceramic 10pF ±5%	
C58, 59	CK45D1H102M	Ceramic 0.001μF ±20%	
C60	CC45CH1H070D	Ceramic 7pF ±0.5pF	
C61	CK45F1H103Z	Ceramic 0.01μF +80%, -20%	
C62, 63	CC45CH1H100J	Ceramic 10pF ±5%	
C64, 65	CK45D1H102M	Ceramic 0.001μF ±20%	
C66	CK45F1H103Z	Ceramic 0.01μF +80%, -20%	
C67	CC45SL1H221J	Ceramic 22pF ±5%	
C68	CC45SL1H221J	Ceramic 220pF ±5%	
C69	CK45F1H103Z	Ceramic 0.01μF +80%, -20%	
C70	CC45CH1H030C	Ceramic 3pF ±0.25pF	
C71	CC45CH1H390J	Ceramic 39pF ±5%	
C72	CC45SL1H220J	Ceramic 22pF ±5%	
C73	CK45F1H103Z	Ceramic 0.01μF +80%, -20%	
C74	CC45SL1H100J	Ceramic 10pF ±5%	
C75, 76	CK45F1H103Z	Ceramic 0.01μF +80%, -20%	
C77	CC45SL1H100J	Ceramic 10pF ±5%	
C78	CC45SL1H101J	Ceramic 100pF ±5%	
C79, 80	CK45F1H103Z	Ceramic 0.01μF +80%, -20%	
C81	CE04W1H010(RL)	Electrolytic 1μF 50WV	
C82, 83	CK45F1H103Z	Ceramic 0.01μF 50WV	
C84	CC45SL1H470J	Ceramic 47pF ±5%	
C85	CK45F1H103J	Ceramic 0.01μF +80%, -20%	

PARTS LIST

Ref. No.	Parts No.	Description	Re- marks
C86	CC45CH1H330J	Ceramic 33pF ±5%	
C87, 83	CK45F1H103Z	Ceramic 0.01μF +80%, -20%	
C89	CC45CH1H050D	Ceramic 5pF ±0.5pF	
C90	CK45D1H102M	Ceramic 0.001μF ±20%	
C91	CC45CH1H050D	Ceramic 5pF ±0.5pF	
C92, 93	C90-0231-05	Ceramic 0.5pF	
C94 ~ 96	CC45CH1H070D	Ceramic 7pF ±0.5pF	
C97	CC45SL1H101J	Ceramic 100pF ±5%	
C98	CK45F1H103Z	Ceramic 0.01μF +80%, -20%	
C99	CK45D1H102M	Ceramic 0.001μF ±20%	
C100	CK45F1H103Z	Ceramic 0.01μF +80%, -20%	
C101	CK45D1H102M	Ceramic 0.001μF ±20%	
C102	CK45F1H103Z	Ceramic 0.01μF +80%, -20%	
C103	CK45D1H102M	Ceramic 0.001μF ±20%	
C104	CC45SL1H070D	Ceramic 7pF ±0.5pF	
C105	CK45D1H102M	Ceramic 0.001μF ±20%	
C106	CC45SL1H270J	Ceramic 27pF ±5%	
C107	CK45D1H102M	Ceramic 0.001μF ±20%	
C108	CK45F1H103Z	Ceramic 0.01μF +80%, -20%	
C109	CK45D1H102M	Ceramic 0.001μF ±20%	
C110	CC45SL1H100J	Ceramic 10pF ±5%	
C111	CE04W1A470(RL)	Electrolytic 47μF 10WV	
C112	CK45F1H103Z	Ceramic 0.01μF +80%, -20%	
RESISTOR			
R1~12	PD14CY2E182J	Carbon 1.8kΩ ±5% 1/4W	
R13 ~ 16	PD14CY2E102J	Carbon 1kΩ ±5% 1/4W	
R17	PD14CY2E333J	Carbon 33kΩ ±5% 1/4W	
R18	PD14CY2E472J	Carbon 4.7kΩ ±5% 1/4W	
R19	PD14CY2E221J	Carbon 220Ω ±5% 1/4W	
R20, 21	PD14CY2E332J	Carbon 3.3kΩ ±5% 1/4W	
R22	PD14CY2E223J	Carbon 22kΩ ±5% 1/4W	
R23	PD14CY2E153J	Carbon 15kΩ ±5% 1/4W	
R24	PD14CY2E820J	Carbon 82Ω ±5% 1/4W	
R25	PD14CY2E220J	Carbon 22Ω ±5% 1/4W	
R26	PD14CY2E471J	Carbon 470Ω ±5% 1/4W	
R27, 28	PD14CY2E470J	Carbon 47Ω ±5% 1/4W	
R29	PD14CY2E471J	Carbon 470Ω ±5% 1/4W	
R30, 31	RN92A3D010K	Metal plate 1Ω ±10% 2W	
R32	RC05GF2H100J	Carbon 10Ω ±5% 1/2W	
R33	PD14CY2E471J	Carbon 470Ω ±5% 1/4W	
R34	PD14CY2E473J	Carbon 47kΩ ±5% 1/4W	
R35	PD14CY2E562J	Carbon 5.6kΩ ±5% 1/4W	
R36	PD14CY2E473J	Carbon 47kΩ ±5% 1/4W	
R37	PD14CY2E472J	Carbon 4.7kΩ ±5% 1/4W	
R38	PD14CY2E223J	Carbon 22kΩ ±5% 1/4W	
R39	PD14CY2E561J	Carbon 560Ω ±5% 1/4W	
R40	PD14CY2E101J	Carbon 100Ω ±5% 1/4W	
R41	PD14CY2E223J	Carbon 22kΩ ±5% 1/4W	
R42	PD14CY2E102J	Carbon 1kΩ ±5% 1/4W	
R43	PD14CY2E221J	Carbon 220Ω ±5% 1/4W	
R44	PD14CY2E101J	Carbon 100Ω ±5% 1/4W	
R45, 46	PD14CY2E103J	Carbon 10kΩ ±5% 1/4W	
R47	PD14CY2E101J	Carbon 100Ω ±5% 1/4W	
R48	PD14CY2E562J	Carbon 5.6kΩ ±5% 1/4W	
R49	PD14CY2E153J	Carbon 15kΩ ±5% 1/4W	
R50	PD14CY2E472J	Carbon 4.7kΩ ±5% 1/4W	
R51, 52	PD14CY2E101J	Carbon 100Ω ±5% 1/4W	
R53	PD14CY2E102J	Carbon 1kΩ ±5% 1/4W	
R55	PD14CY2E152J	Carbon 1.5Ω ±5% 1/4W	
R56	PD14CY2E153J	Carbon 15kΩ ±5% 1/4W	
R57	PD14CY2E473J	Carbon 47kΩ ±5% 1/4W	

Ref. No.	Parts No.	Description	Re- marks
R58	PD14CY2E223J	Carbon 22kΩ ±5% 1/4W	
R59	PD14CY2E271J	Carbon 270Ω ±5% 1/4W	
R60	PD14CY2E682J	Carbon 6.8kΩ ±5% 1/4W	
R61	PD14CY2E221J	Carbon 220Ω ±5% 1/4W	
R62	PD14CY2E472J	Carbon 4.7kΩ ±5% 1/4W	
R63	PD14CY2E103J	Carbon 10kΩ ±5% 1/4W	
R64	PD14CY2E471J	Carbon 470Ω ±5% 1/4W	
R65	PD14CY2E272J	Carbon 2.7kΩ ±5% 1/4W	
R66	PD14CY2E102J	Carbon 1kΩ ±5% 1/4W	
R67	PD14CY2E473J	Carbon 47kΩ ±5% 1/4W	
R68	PD14CY2E101J	Carbon 100Ω ±5% 1/4W	
R69	PD14CY2E103J	Carbon 10kΩ ±5% 1/4W	
R71	PD14CY2E222J	Carbon 2.2kΩ ±5% 1/4W	
R72	PD14CY2E101J	Carbon 100Ω ±5% 1/4W	
R73	PD14CY2E561J	Carbon 560Ω ±5% 1/4W	
R74, 75	PD14CY2E103J	Carbon 10kΩ ±5% 1/4W	
R76	PD14CY2E101J	Carbon 100Ω ±5% 1/4W	
R77	PD14CY2E562J	Carbon 5.6kΩ ±5% 1/4W	
R80	PD14CY2E100J	Carbon 10Ω ±5% 1/4W	
R82	PD14CY2E222J	Carbon 2.2kΩ ±5% 1/4W	
R83	PD14CY2E470J	Carbon 47Ω ±5% 1/4W	
R84	PD14CY2E100J	Carbon 10Ω ±5% 1/4W	
R85	PD14CY2E102J	Carbon 1kΩ ±5% 1/4W	
R86	RC05GF2H6R8J	Carbon 6.8Ω ±5% 1/2W	
R87	PD14CY2E223J	Carbon 22kΩ ±5% 1/4W	
R88	PD14CY2E103J	Carbon 10kΩ ±5% 1/4W	
R89	PD14CY2E151J	Carbon 150Ω ±5% 1/4W	
R90	PD14CY2E330J	Carbon 33Ω ±5% 1/4W	
SEMICONDUCTOR			
Q1	V03-0125-05	Transistor 2SC734 (Y)	
Q2, 3	V04-0046-05	Transistor 2SD235 (Y, O)	
Q4	V03-0336-05	Transistor 2SC496 (Y, O)	
Q5, 6	V03-0079-05	Transistor 2SC460 (B)	
Q7, 8	V09-0012-05	FET 2SK19 (GR)	
Q9	V09-0069-05	FET 3SK41 (L, M)	
Q10 ~ 12	V03-0079-05	Transistor 2SC460 (B)	
Q13	V09-0036-05	FET 3SK35 (GR, BL)	
Q14, 15	V09-0012-05	FET 2SK19 (GR)	
Q16	V09-0069-05	FET 3SK41 (L, M)	
Q17	V03-0168-05	Transistor 2SC998	
Q18	V03-0129-05	Transistor 2SC733 (Y)	
D1~18	V11-0076-05	Diode 1S1555	
D19	V11-0317-05	Diode 1S2208	
D20	V11-0192-05	Diode 1S1658-1	
D21	V11-0240-05	Zener diode WZ-090	
D23, 24		Diode 1S1587	
D25	V11-0076-05	Diode 1S1555	
D26	V11-0240-05	Zener diode WZ-090	
POTENTIOMETER			
VR1, 2	R12-1020-05	Volume 1kΩ	
VR3	R12-3025-05	Volume 10kΩ	
COIL/TRIMMER			
L1 ~ 4	L31-0346-05	Tuning coil	
L5	L40-2201-03	Ferri-inductor 22μH	
L6	L34-0438-05	Coil 0.9μH	
L7	L40-1021-03	Ferri-inductor 1mH	
L8, 9	L40-1005-44	Ferri-inductor 10μH	
L10	L12-0013-05	Input transformer	
L11	L32-0002-05	Tuning coil	
L12, 13	L31-0266-05	Tuning coil	

PARTS LIST

Ref. No.	Parts No.	Description	Re- marks
L14	L31-0313-05	Tuning coil	
L15	L31-0344-05	Tuning coil	
L16	L31-0180-05	Tuning coil	
L17, 18	L31-0267-05	Tuning coil	
L19	L31-0180-05	Tuning coil	
L20	L40-6891-02	Ferri-inductor 6.8μH	
L21	L40-1021-03	Ferri-inductor 1mH	
L22	L30-0005-05	IFT	
L23	L31-0313-05	Tuning coil	
L24	L31-0344-05	Tuning coil	
L25	L31-0180-05	Tuning coil	
L26, 27	L31-0267-05	Tuning coil	
L28	L33-0025-05	Choke coil 1μH	
L29	L34-0463-05	VHF coil	
L30	L34-0462-05	VHF coil	
L31	L34-0461-05	VHF coil	
L32	L34-0462-05	VHF coil	
L33	L40-1021-03	Ferri-inductor 1mH	
TC1~12	C05-0030-15	Ceramic trimmer 20pF	
TC13	C05-0031-15	Ceramic trimmer 10pF	
TC14	C05-0030-15	Ceramic trimmer 20pF	
TC15,16	C05-0013-15	Ceramic trimmer 20pF	

X'tal

X1	L77-0386-05	Crystal oscillator 41.7005MHz	
X2	L77-0387-05	Crystal oscillator 41.7022MHz	
X3	L77-0388-05	Crystal oscillator 41.7038MHz	
X4	L77-0389-05	Crystal oscillator 41.7055MHz	
A1	L77-0390-05	Crystal oscillator 8.3000MHz	
A2	L77-0391-05	Crystal oscillator 8.3200MHz	
A3	L77-0392-05	Crystal oscillator 8.3400MHz	
A4	L77-0393-05	Crystal oscillator 8.3600MHz	
A5	L77-0394-05	Crystal oscillator 8.3800MHz	
B1	L77-0395-05	Crystal oscillator 8.4000MHz	
B2	L77-0396-05	Crystal oscillator 8.4200MHz	
B3	L77-0397-05	Crystal oscillator 8.4400MHz	
B4	L77-0398-05	Crystal oscillator 8.4600MHz	
B5	L77-0399-05	Crystal oscillator 8.4800MHz	

MISCELLANEOUS

-	E18-0201-05	Crystal socket	
-	E23-0046-04	Terminal x 4	
-	E23-0047-04	Terminal x 42	
-	F01-0150-14	Heat sink	
-	F10-0347-04	Shield plate (B)	
-	F10-0350-04	Shield plate (D)	
-	F20-0078-05	Insulator x 2	
-	J25-1104-12	PC board	

■ FILTER (X51-1110-00)

Ref. No.	Parts No.	Description	Re- marks
CAPACITOR			
C1	CC45SL1H470J	Ceramic 47pF ±5%	
C2	CK45D1H102M	Ceramic 0.001μF ±20%	
C3	CC45SL2H470J	Ceramic 47pF ±5%	

Ref. No.	Parts No.	Description	Re- marks
C5, 6	CC45SL2H220J	Ceramic 22pF ±5%	
C7	CC45SL1H010C	Ceramic 1pF ±0.25pF	
C8	CK45D1H102M	Ceramic 0.001μF ±20%	
C10	CC45SL1H070D	Ceramic 7pF ±0.5pF	
C11	CK45D1H102M	Ceramic 0.001μF ±20%	
C12	CC45SL2H100J	Ceramic 10pF ±5%	
C13	CK45F1H103Z	Ceramic 0.01μF +80%, -20%	
C14	CK45D1H102M	Ceramic 0.001μF ±20%	
C16 ~ 18	CK45F1H103Z	Ceramic 0.01μF +80%, -20%	
C19	CE04W1C100(RL)	Electrolytic 10μF 16WV	
C20	C90-0231-05	Ceramic 0.5pF	

RESISTOR

R1	PD14CY2E221J	Carbon 220Ω ±5% 1/4W	
R2, 3	PD14CY2E473J	Carbon 47kΩ ±5% 1/4W	

SEMICONDUCTOR

Q1	V03-0123-05	Transistor 2SC733 (Y or O)	
D1, 2	V11-0255-05	Diode M1301	
D3 ~ 6	V11-0051-05	Diode 1N60	

POTENTIOMETER

VR1	R12-4016-05	Volume 50kΩ	
VR2	R12-0042-05	Volume 500Ω	
VR3	R12-3025-05	Volume 10kΩ	

COIL

L1	L40-1001-03	Ferri-inductor 10μH	
L2	L34-0387-05	VHF coil	
L3, 4	L34-0430-05	VHF coil	
L5	L40-1001-03	Ferri-inductor 10μH	
L6	L40-1021-03	Ferri-inductor 1mH	
L7	L39-0052-05	Detecting coil	

MISCELLANEOUS

-	E23-0046-04	Terminal x 2	
-	E23-0047-04	Terminal x 8	
-	J25-1101-14	PC board	

■ RX (X55-1080-00)

Ref. No.	Parts No.	Description	Re- marks
CAPACITOR			
C1	CC45CH1H470J	Ceramic 47pF ±5%	
C2	CC45RH1H100J	Ceramic 10pF ±5%	
C3	CC45CH1H010C	Ceramic 1pF ±0.25pF	
C4	CC45CH1H030C	Ceramic 3pF ±0.25pF	
C5	CC45CH1H330J	Ceramic 33pF ±5%	
C6, 7	CK45F1H103Z	Ceramic 0.01μF +80%, -20%	
C8	CK45D1H102M	Ceramic 0.001μF ±20%	
C9	CK45F1H103Z	Ceramic 0.01μF +80%, -20%	
C10	C90-0018-05	Ceramic 0.001μF	
C11	CC45SL1H101K	Ceramic 100pF ±10%	
C12	CC45CH1H330J	Ceramic 33pF ±5%	
C13	CK45F1H103Z	Ceramic 0.01μF +80%, -20%	
C14	CK45D1H102M	Ceramic 0.001μF ±20%	

PARTS LIST

Ref. No.	Parts No.	Description	Re- marks
C15	CK45F1H103Z	Ceramic 0.01μF +80%, -20%	
C16	CC45CH1H010C	Ceramic 1pF ±0.25pF	
C17	CQ92M1H223K	Mylar 0.022μF ±10%	
C18	CC45CH1H070D	Ceramic 7pF ±0.5pF	
C19 ~ 21	CK45F1H103Z	Ceramic 0.01μF +80%, -20%	
C22	CE04W1C100(RL)	Electrolytic 10μF 16WV	
C23	CK45D1H102M	Ceramic 0.001μF ±20%	
C24	CQ92M1H223K	Mylar 0.022μF ±10%	
C25	CK45F1H103Z	Ceramic 0.01μF +80%, -20%	
C26	CK45D1H102M	Ceramic 0.001μF ±20%	
C27	CE04W1C100(RL)	Electrolytic 10μF 16WV	
C28	CK45D1H102M	Ceramic 0.01μF ±20%	
C29	CC45CH1H330J	Ceramic 33pF ±5%	
C30, 31	CK45F1H103Z	Ceramic 0.01μF +80%, -20%	
C32	CC45SL1H470J	Ceramic 47pF ±5%	
C33	CK45F1H103Z	Ceramic 0.01μF +80%, -20%	
C34, 35	CQ92M1H393K	Mylar 0.039μF ±10%	
C36	CK45F1H103Z	Ceramic 0.01μF +80%, -20%	
C37	CC45SL1H470J	Ceramic 47pF ±5%	
C38 ~ 40	CK45F1H103Z	Ceramic 0.01μF +80%, -20%	
C41	CQ92M1H223K	Mylar 0.022μF ±10%	
C42, 43	CK45F1H103Z	Ceramic 0.01μF +80%, -20%	
C44	CQ92M1H223K	Mylar 0.022μF ±10%	
C45	CC45CH1H010C	Ceramic 1pF ±0.25pF	
C46	CK45D1H102M	Ceramic 0.001μF ±20%	
C47, 48	CK45F1H103Z	Ceramic 0.01μF +80%, -20%	
C49	CK45B1H331K	Ceramic 330pF ±10%	
C50	CK45F1H203Z	Ceramic 0.02μF +80%, -20%	
C51	CE04W1C100(RL)	Electrolytic 10μF 16WV	
C52	CK45F1H103Z	Ceramic 0.01μF +80%, -20%	
C53	CE04W1H010(RL)	Electrolytic 1μF 50WV	
C54	CK45F1H103Z	Ceramic 0.01μF +80%, -20%	
C55	CQ92M1H223K	Mylar 0.022μF ±10%	
C56	CC45CH1H050D	Ceramic 5pF ±0.5pF	
C57	CC45SL1H470J	Ceramic 47pF ±5%	
C58	CK45F1H103Z	Ceramic 0.01μF +80%, -20%	
C59	CE04W1H3R3(RL)	Electrolytic 3.3μF 50WV	
C60, 61	CK45F1H103Z	Ceramic 0.01μF +80%, -20%	
C62	CE04W1H4R7(RL)	Electrolytic 4.7μF 50WV	
C63	CK45F1H203Z	Ceramic 0.02μF +80%, -20%	
C64	CK45F1H103Z	Ceramic 0.01μF +80%, -20%	
C65, 66	CQ92M1H393K	Mylar 0.039μF ±10%	
C67	CK45F1H103Z	Ceramic 0.01μF +80%, -20%	
C68, 69	CC45CH1H330J	Ceramic 33pF ±5%	
C70	CK45F1H103Z	Ceramic 0.01μF +80%, -20%	
C71	CQ92M1H103K	Mylar 0.01μF ±10%	
C72	CQ92M1H473K	Mylar 0.047μF ±10%	
C73	CE04W1H010(RL)	Electrolytic 1μF 50WV	
C74	CE04W1C100(RL)	Electrolytic 10μF 16WV	
C75	CE04W1A470(RL)	Electrolytic 47μF 10WV	
C76	CE04W1H010(RL)	Electrolytic 1μ 50WV	
C77	CK45F1H203Z	Ceramic 0.002μF +80%, -20%	
C78, 79	CK45F1H103Z	Ceramic 0.01μF +80%, -20%	
C80	CE04W1H010(RL)	Electrolytic 1μF 50WV	
C81	CQ92M1H223K	Mylar 0.022μF ±10%	
RESISTOR			
R1	PD14CY2E104J	Carbon 100kΩ ±5% 1/4W	
R2	PD14CY2E332J	Carbon 3.3kΩ ±5% 1/4W	
R3	PD14CY2E474J	Carbon 470kΩ ±5% 1/4W	
R4, 5	PD14CY2E101J	Carbon 100Ω ±5% 1/4W	

Ref. No.	Parts No.	Description	Re- marks
R6, 7	PD14CY2E104J	Carbon 100kΩ ±5% 1/4W	
R8	PD14CY2E102J	Carbon 1kΩ ±5% 1/4W	
R9	PD14CY2E471J	Carbon 470Ω ±5% 1/4W	
R10	PD14CY2E101J	Carbon 100Ω ±5% 1/4W	
R11	PD14CY2E472J	Carbon 4.7kΩ ±5% 1/4W	
R12	PD14CY2E223J	Carbon 22kΩ ±5% 1/4W	
R13	PD14CY2E102J	Carbon 1kΩ ±5% 1/4W	
R14	PD14CY2E221J	Carbon 220Ω ±5% 1/4W	
R15	PD14CY2E102J	Carbon 1kΩ ±5% 1/4W	
R16, 17	PD14CY2E472J	Carbon 4.7kΩ ±5% 1/4W	
R18	PD14CY2E223J	Carbon 22kΩ ±5% 1/4W	
R19	PD14CY2E682J	Carbon 6.8kΩ ±5% 1/4W	
R20	PD14CY2E102J	Carbon 1kΩ ±5% 1/4W	
R21	PD14CY2E103J	Carbon 10kΩ ±5% 1/4W	
R22	PD14CY2E152J	Carbon 1.5kΩ ±5% 1/4W	
R23	PD14CY2E103J	Carbon 10kΩ ±5% 1/4W	
R24	PD14CY2E102J	Carbon 1kΩ ±5% 1/4W	
R25	PD14CY2E182J	Carbon 1.8kΩ ±5% 1/4W	
R26	PD14CY2E103J	Carbon 10kΩ ±5% 1/4W	
R28	PD14CY2E221J	Carbon 220Ω ±5% 1/4W	
R29	PD14CY2E101J	Carbon 100Ω ±5% 1/4W	
R30	PD14CY2E472J	Carbon 47kΩ ±5% 1/4W	
R31	PD14CY2E562J	Carbon 5.6kΩ ±5% 1/4W	
R32	PD14CY2E474J	Carbon 470kΩ ±5% 1/4W	
R33	PD14CY2E682J	Carbon 6.8kΩ ±5% 1/4W	
R34	PD14CY2E393J	Carbon 39kΩ ±5% 1/4W	
R35	PD14CY2E273J	Carbon 27kΩ ±5% 1/4W	
R36	PD14CY2E471J	Carbon 470Ω ±5% 1/4W	
R37	PD14CY2E103J	Carbon 10kΩ ±5% 1/4W	
R38	PD14CY2E470J	Carbon 47Ω ±5% 1/4W	
R39	PD14CY2E221J	Carbon 220Ω ±5% 1/4W	
R40	PD14CY2E103J	Carbon 10kΩ ±5% 1/4W	
R41	PD14CY2E101J	Carbon 100Ω ±5% 1/4W	
R42	PD14CY2E221J	Carbon 220Ω ±5% 1/4W	
R43, 44	PD14CY2E103J	Carbon 10kΩ ±5% 1/4W	
R45	PD14CY2E333J	Carbon 33kΩ ±5% 1/4W	
R46	PD14CY2E153J	Carbon 15kΩ ±5% 1/4W	
R47, 48	PD14CY2E223J	Carbon 22kΩ ±5% 1/4W	
R49	PD14CY2E103J	Carbon 10kΩ ±5% 1/4W	
R50	PD14CY2E105J	Carbon 1MΩ ±5% 1/4W	
R51	PD14CY2E222J	Carbon 2.2kΩ ±5% 1/4W	
R52	PD14CY2E103J	Carbon 10kΩ ±5% 1/4W	
R53	PD14CY2E473J	Carbon 47kΩ ±5% 1/4W	
R54	PD14CY2E103J	Carbon 10kΩ ±5% 1/4W	
R55	PD14CY2E154J	Carbon 150kΩ ±5% 1/4W	
R56	PD14CY2E103J	Carbon 10kΩ ±5% 1/4W	
R58	PD14CY2E221J	Carbon 220Ω ±5% 1/4W	
R59	PD14CY2E101J	Carbon 100Ω ±5% 1/4W	
R60	PD14CY2E223J	Carbon 22kΩ ±5% 1/4W	
R61	PD14CY2E562J	Carbon 5.6kΩ ±5% 1/4W	
R62	PD14CY2E101J	Carbon 100Ω ±5% 1/4W	
R63	PD14CY2E102J	Carbon 1kΩ ±5% 1/4W	
R64	PD14CY2E222J	Carbon 2.2kΩ ±5% 1/4W	
R65	RC05GF2H680J	Carbon 68Ω ±5% 1/2W	
R66	PD14CY2E182J	Carbon 1.8kΩ ±5% 1/4W	
R67	PD14CY2E471J	Carbon 470Ω ±5% 1/4W	
R68	PD14CY2E224J	Carbon 220kΩ ±5% 1/4W	
R69	PD14CY2E470J	Carbon 47Ω ±5% 1/4W	
R70	PD14CY2E153J	Carbon 15kΩ ±5% 1/4W	
R71	PD14BY2E104J	Carbon 100kΩ ±5% 1/4W	
SEMICONDUCTOR			
Q1	V09-0057-05	FET 3SK41 (L)	

PARTS LIST

Ref. No.	Parts No.	Description	Re- marks	Ref. No.	Parts No.	Description	Re- marks
Q2	V09-0036-05	FET 3SK35 (GR)					
Q3, 4	V03-0079-05	Transistor 2SC460 (B)					
Q5	V09-0036-05	FET 3SK35 (GR)					
Q6	V09-0012-05	FET 2SK19 (GR)					
Q7	V03-0214-05	Transistor 2SA495 (Y, O)					
Q8	V03-0094-05	Transistor 2SC458 (B)					
Q9	V03-0079-05	Transistor 2SC460 (B)					
Q10, 11	V03-0123-05	Transistor 2SC733 (Y, O)					
Q12	V03-0094-05	Transistor 2SC458 (B)					
Q13	V03-0123-05	Transistor 2SC733 (Y, O)					
Q14	V09-0036-05	FET 3SK35 (GR)					
Q15	V03-0129-05	Transistor 2SC733 (Y)					
D1 ~ 7	V11-0056-05	Diode 1S1587					
D8 ~ 11	V11-0051-05	Diode 1N60					
D12	V11-0076-05	Diode 1S1555					
D13	V11-0240-05	Zener diode WZ-090					
D14 ~ 20	V11-0051-05	Diode 1N60					
POTENTIOMETER							
VR1	R12-7013-05	Volume 50k Ω					
VR2, 3	R12-1020-05	Volume 1k Ω					
VR4	R12-0042-05	Volume 500 Ω					
COIL/TRIMMER							
L1	L31-0266-05	Tuning coil					
L2	L31-0267-05	ANT coil					
L3	L34-0390-05	VHF coil (B)					
L4	L34-0389-05	VHF coil (A)					
L5	L34-0390-05	VHF coil (B)					
L6	L30-0005-05	IFT					
L7	L71-0021-05	Crystal filter					
L8	L30-0005-05	IFT					
L9 ~ 11	L40-1021-03	Ferri-inductor 1mH					
L12	L71-0022-05	Crystal filter					
L13, 14	L40-1021-03	Ferri-inductor 1mH					
L15 ~ 18	L30-0005-05	IFT					
L19	L40-1021-03	Ferri-inductor 1mH					
L20	L40-1092-03	Ferri-inductor 1mH					
L21	L40-1021-03	Ferri-inductor 1mH					
L22	L33-0005-05	IFT					
L23 ~ 25	L40-1021-03	Ferri-inductor 1mH					
TC1 ~ 3	C05-0039-05	Ceramic trimmer 6pF					
MISCELLANEOUS							
-	E23-0046-04	Terminal x 3					
-	E23-0047-04	Terminal x 24					
-	E23-0055-05	Hermetic seal					
-	F11-0156-04	Shield case					
-	J25-1103-03	PC board					

TROUBLESHOOTING

TROUBLE	PROBABLE CAUSE		REMEDY
1. Power is not supplied	1) Fuse 2) Power cord 3) Power switch	<input type="radio"/> Fuse blown <input type="radio"/> Capacity insufficient <input type="radio"/> Plug connection faulty <input type="radio"/> Power switch defective	Check fuse and replace it, if faulty Replace with fuse of 4A Repair plug connection, if faulty Repair power switch, if defective
2. Fuse is blown (during reception)	1) Power supply 2) B circuit 3) AF final stage	<input type="radio"/> Polarity reversed <input type="radio"/> D9 (U05B) faulty <input type="radio"/> Q7 (2SC735) faulty <input type="radio"/> Q2 or Q3 (2SD235) faulty	Change polarity Replace D9, if defective Replace Q7, if defective Replace Q2 or Q3, if defective
(during transmission)	1) Final unit	<input type="radio"/> Q2 (2SC1242A) faulty	Replace Q2, if defective
3. No signal is received at all (Even noise is not heard)	1) AF final stage 2) Speaker cord 3) AF VR	<input type="radio"/> Q2 or Q3 (2SD235) faulty <input type="radio"/> Broken wire <input type="radio"/> Poor contact <input type="radio"/> No oscillation	Check voltage against rating Repair speaker cord, if defective Repair contact, if poor Check oscillator voltage against rating Adjust coil properly
(Noise is heard)	1) Synthesizer unit	<input type="radio"/> No oscillation	Check oscillator voltage against rating
(S meter operates)	2) IF circuit 3) Carrier unit	<input type="radio"/> Coil not properly adjusted <input type="radio"/> No oscillation	Adjust coil properly
4. Sensitivity is too low	1) RF circuit	<input type="radio"/> Q1 (3SD41) faulty <input type="radio"/> Helical part not properly adjusted <input type="radio"/> RF coil not properly adjusted <input type="radio"/> Output level too low	Check voltage against rating Adjust helical part properly Adjust RF coil properly
(S meter operates)	2) Synthesizer unit 3) IF circuit 4) Carrier unit	<input type="radio"/> Coil not properly adjusted <input type="radio"/> Filter (L7, L12) faulty <input type="radio"/> Carrier output too low	Check voltage and adjust it properly Adjust coil properly Replace filter, if defective Adjust carrier output properly
5. S meter does not operate	1) Sensitivity 2) RX unit 3) RX unit	<input type="radio"/> Refer to Step 4 above <input type="radio"/> VR1, VR2 or VR4 not properly adjusted <input type="radio"/> AGC circuit faulty	Adjust VR1, VR2 or VR4 properly Repair AGC circuit, if faulty
6. Sound is distorted	1) AF final stage 2) RX unit 3) Carrier unit	<input type="radio"/> Q2 or Q3 (2SD235) faulty <input type="radio"/> Coil not properly <input type="radio"/> Frequency misaligned or output too low	Replace Q2 or Q3, if defective Adjust coil properly Adjust frequency or output properly
7. NB does not operate	1) NB unit	<input type="radio"/> L17 or L18 not properly adjusted	Adjust L17 or L18 properly
8. RIT does not function properly (ON-OFF switch does not operate properly)	1) Carrier unit VR3	<input type="radio"/> VR3 not properly adjusted	Adjust VR3 properly

TROUBLESHOOTING

TROUBLE	PROBABLE CAUSE		REMEDY
9. CW output is zero (in all channels) (Individual channel)	1) Synthesizer unit	○ No oscillation at 41MHz	Adjust oscillator properly Adjust oscillator properly Replace Q1 or Q2, if defective Replace crystal, if defective
	2) Carrier unit	○ No oscillation	
	3) Final unit	○ Q1 or Q2 faulty	
	1) Synthesizer unit	○ Crystal faulty	
10. CW output is too low	1) Antenna	○ Improper matching	Measure SWR Adjust protection circuit properly Replace Q1 or Q2, if defective Adjust properly Adjust properly Adjust properly Adjust properly
	2) Protection circuit	○ Improper adjustment	
	3) Final unit	○ Q1 or Q2 faulty	
		○ TC1 ~ TC4 not properly adjusted	
	4) Synthesizer unit	○ Heterodyne action not properly adjusted	
	5) Filter unit	○ RF amplifier not properly adjusted ○ ALC (VR3) not properly adjusted	
11. SSB output is zero	1) Microphone	○ Plug connection faulty	Check plug connection for broken wire, and repair, if faulty Replace microphone element, if defective Repair Replace Q5 or Q6, if defective
		○ Microphone element faulty	
	2) Carrier unit	○ Microphone amplifier faulty	
		○ Q5 or Q6 faulty	
12. Carrier leaks	1) Carrier unit	○ Balanced modulating circuit TC1 not properly adjusted	Adjust properly
		○ VR2 not properly adjusted	Adjust properly
13. RF meter reading is too small or too large	1) Filter unit	○ VR1 not properly adjusted	Adjust properly
	2) RX unit	○ D9 faulty	Replace D9, if defective

TR-7010 RECEIVING SECTION

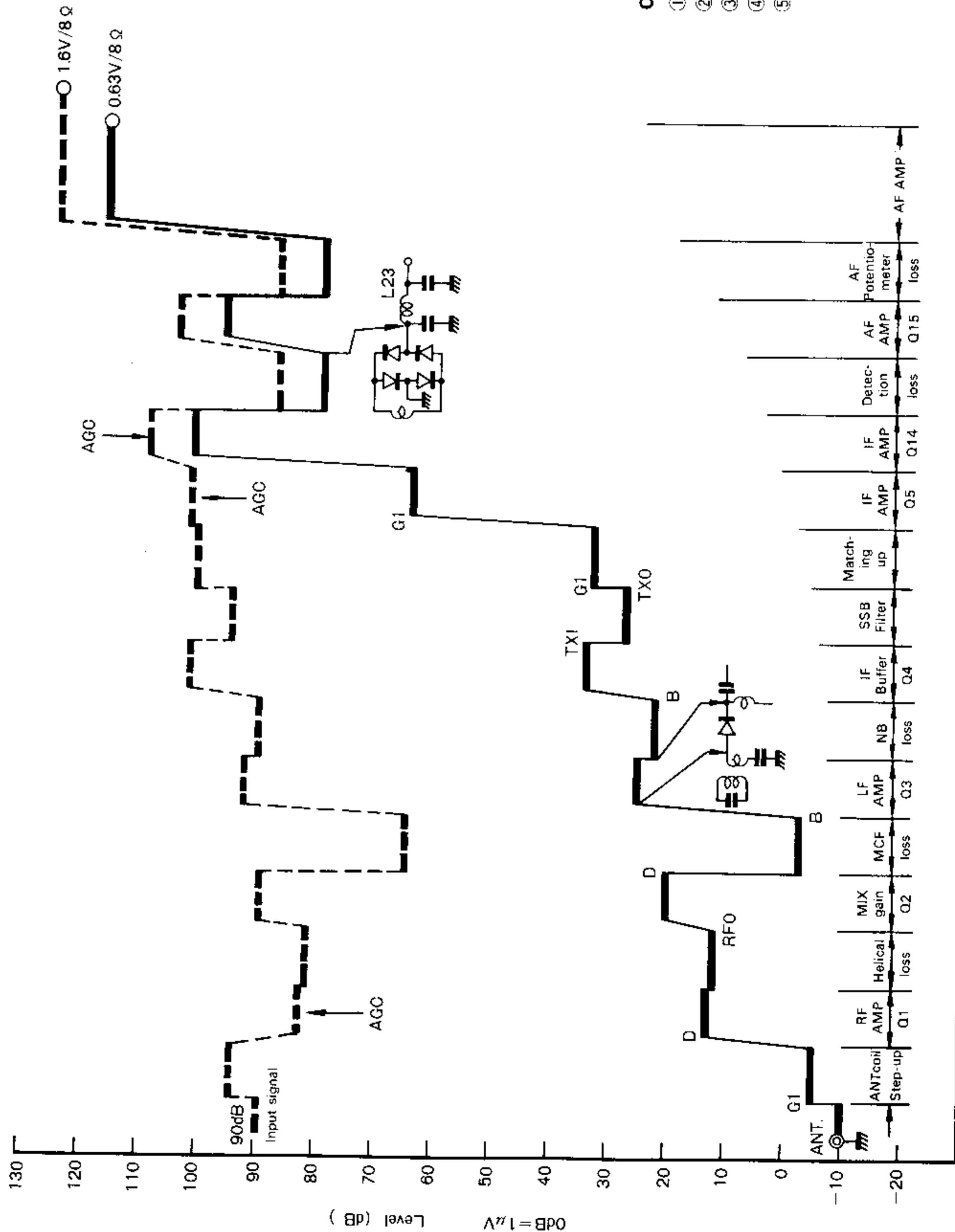

TRANSMITTING POWER SECTION

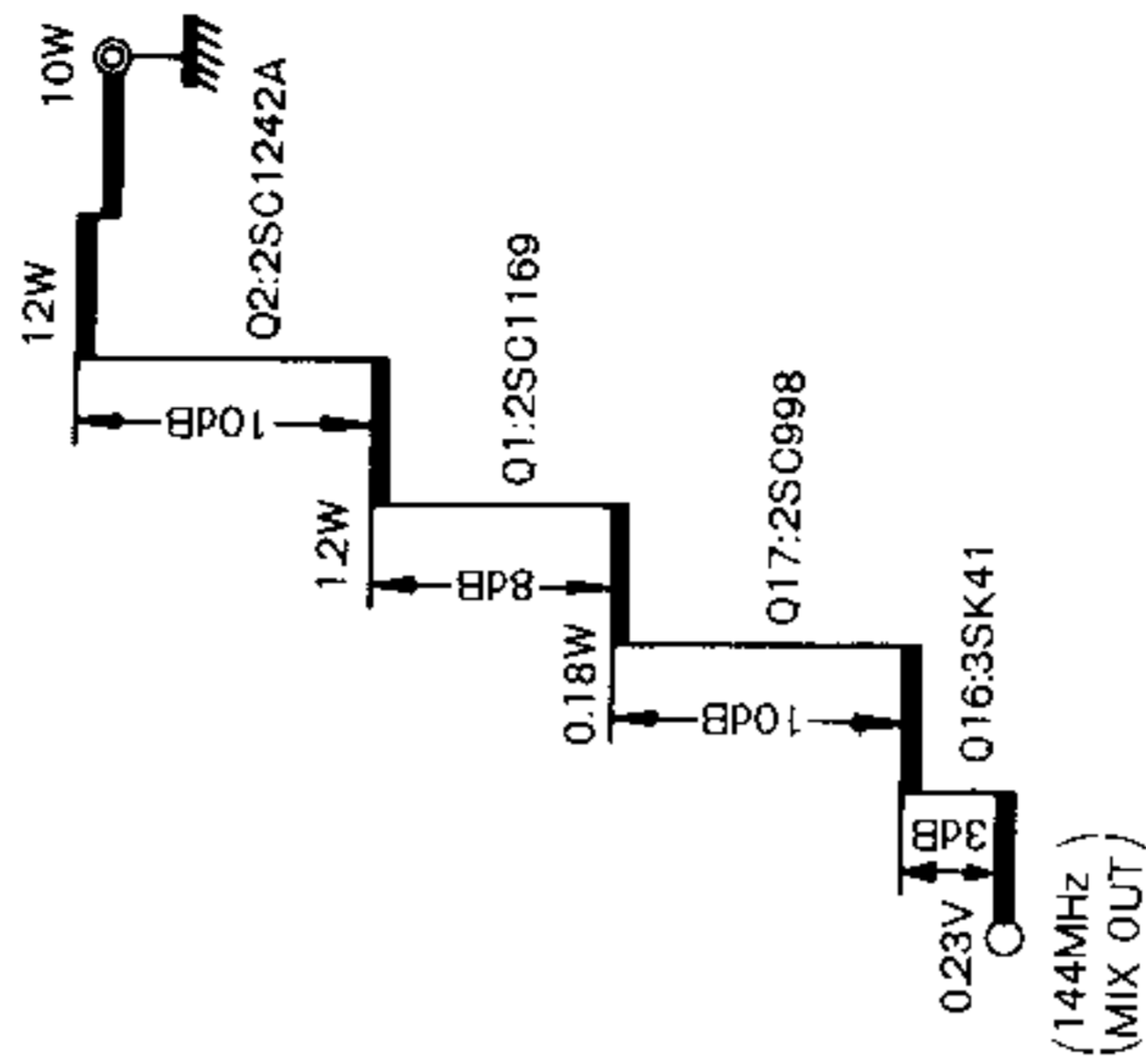

LEVEL DIAGRAM

OSC VOLTAGE

- ① 8 MHz X'tal TP Terminal 0.1V (rsm)
- ② 125 MHz X'tal TP Terminal 0.8V (rms)
- ③ 133 MHz X'tal HET. Terminal 1.1V (rms)
- ④ MIC AMP GAIN 39dB
- ⑤ CARRIER HET. Terminal 0.3V (rms)

LEVEL DIAGRAM

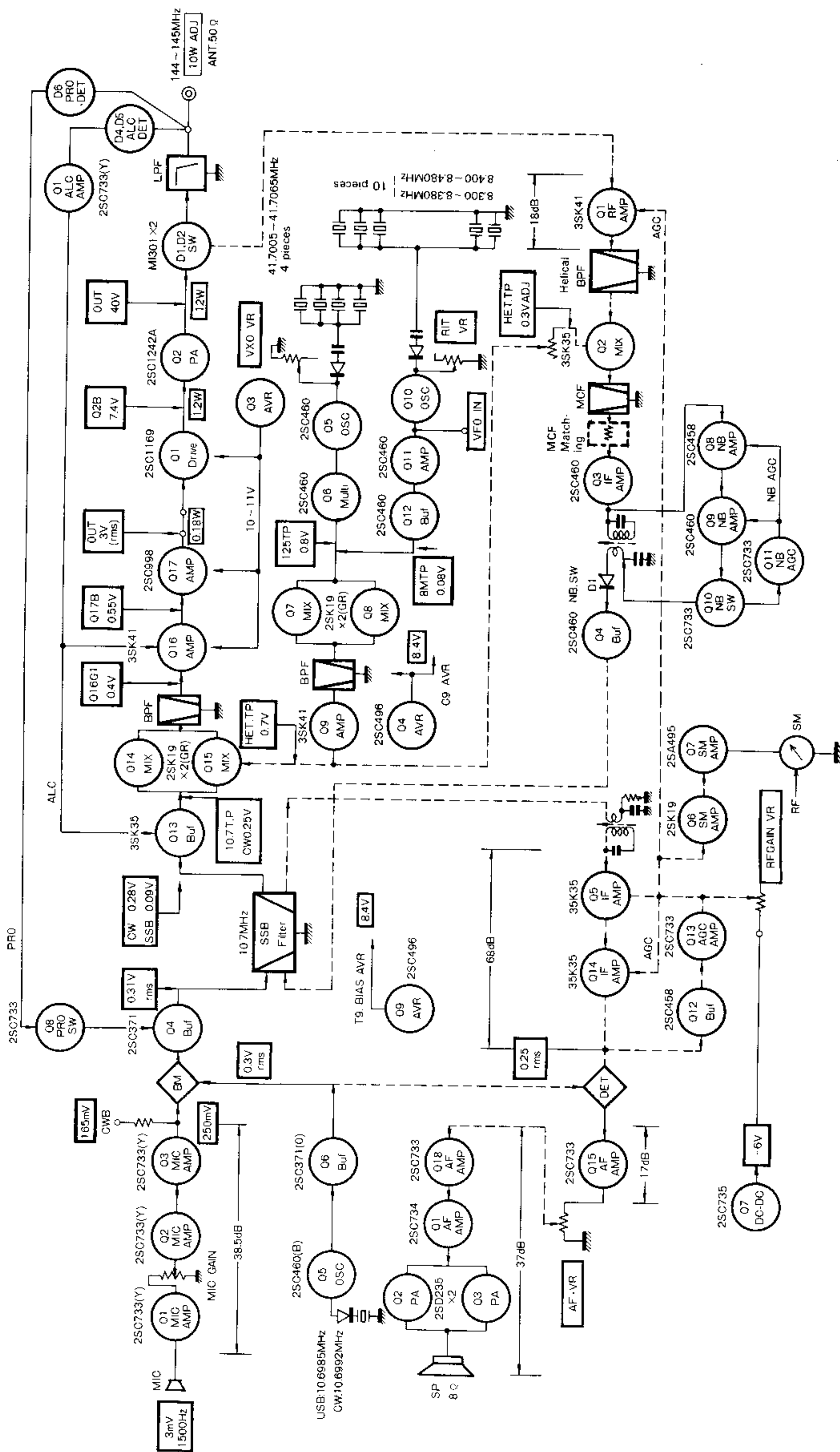

ADJUSTMENTS

TEST EQUIPMENT

1. Frequency Counter

Minimum input voltage: 50mV or less
Frequency range: 200MHz or more

2. RF VTVM

Input impedance: More than 1M Ω , less than 20pF
Voltage range: 10mV ~ 300V Full scale
Frequency range: More than 200MHz

3. Power Meter

50 Ω , 20 ~ 30W, frequency range up to 144MHz or more

4. Standard Signal Generator

Frequencies generated: 144MHz band

5. Oscilloscope

High sensitivity oscilloscope capable of external synchronization

6. Sweep Generator

144MHz band

7. Marker

Oscillating frequency: 144, 145 and 146MHz

8. AF Generator

Frequency range: 300Hz ~ 5kHz
Output: 1V max.

9. AF VTVM

Frequency range: 50Hz ~ 10kHz
Input resistance: More than 1M Ω
Voltage range: 10mV ~ 30V Full scale

10. DC Power Supply

Voltage: 9V ~ 16V
Current: More than 3.5A

11. Ampere Meter

DC 0 ~ 4A

12. Voltmeter

DC 0 ~ 3V (high internal resistance). Tester may be used.

13. Noise Generator

14. Others

AF dummy load, 8 Ω /3W
CW key
Detector

1. Adjustment of 8MHz X'tal Frequency

A. Setting positions of knobs on panel

- (1) RIT volume: Center
- (2) Receiving

B. Adjustment

- (1) Connect frequency counter to TP terminal on the synthesizer unit (see Fig. 1 and Fig. 2).
- (2) Set VFO-SYNTHESIZER selector switch on the rear of the case to SYNTHESIZER position and RIT switch to ON.
Set channel indicator to "80" and BAND switch to "144.2".
- (3) Set TC11 to the center position and adjust TC13 for 8.4800MHz. If this adjustment is difficult, set TC13 as close to 8.4800MHz as possible and then adjust TC11 for 8.4800MHz.

Adjust frequencies in the order given in Table 1.

NOTE: Each frequency should be adjusted within ± 100 Hz.

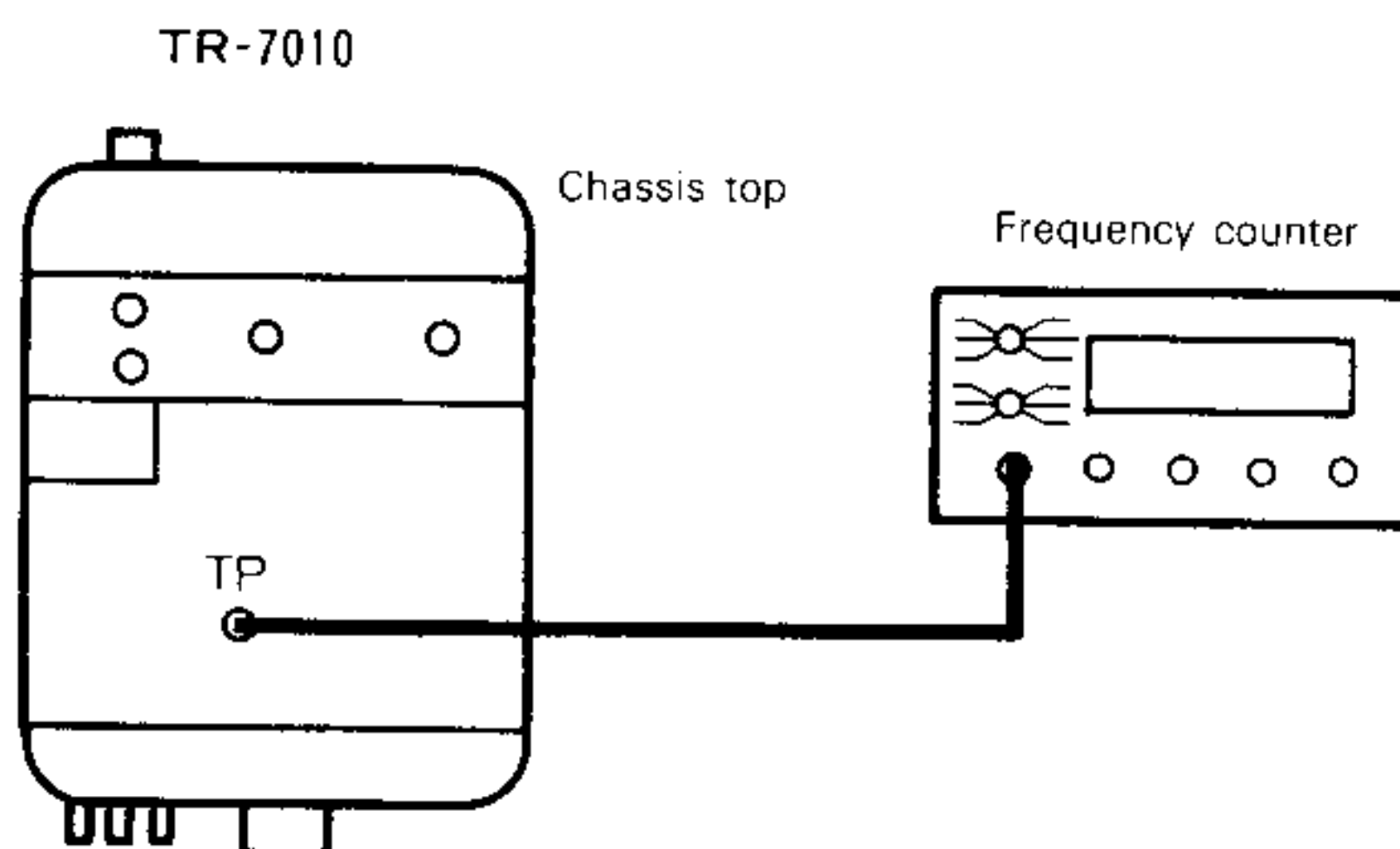

FIG. 1 ADJUSTMENT OF 8MHz FREQUENCIES

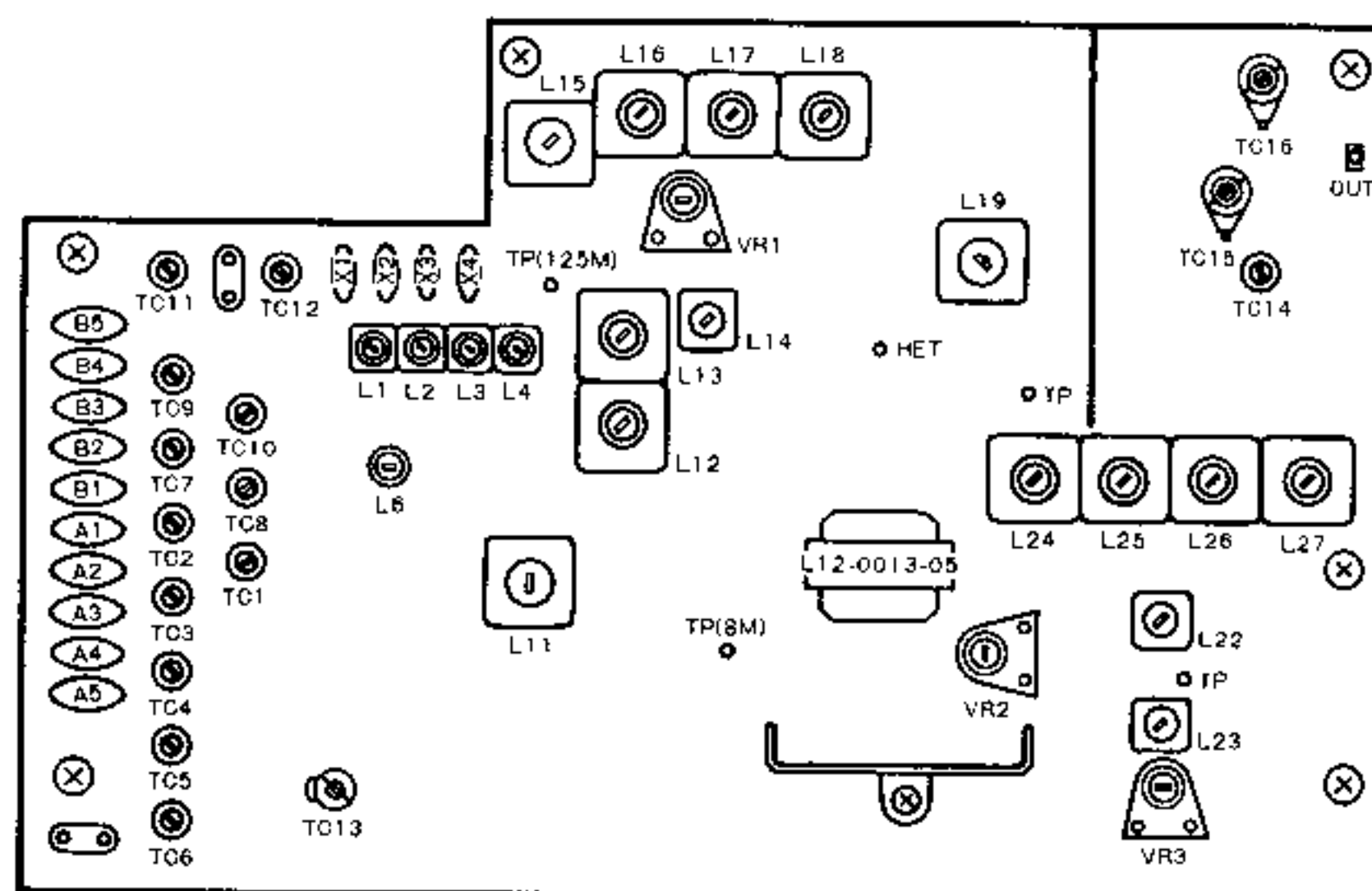

FIG. 2 SYNTHESIZER UNIT

ADJUSTMENTS

Channel Indication	Frequency for Adjustment	Adjusting Trimmer	Operating Frequency
Band Switch Position: 144.2			
60	8.4600MHz	TC10	144.260MHz
40	8.4400MHz	TC9	144.240MHz
20	8.4200MHz	TC8	144.220MHz
00	8.4000MHz	TC7	144.200MHz
Band Switch Position: 144.1			
00	8.3000MHz	TC1	144.100MHz
20	8.3200MHz	TC2	144.120MHz
40	8.3400MHz	TC3	144.140MHz
60	8.3600MHz	TC4	144.160MHz
80	8.3800MHz	TC5	144.180MHz

TABLE 1 ADJUSTING POINTS FOR 8MHz FREQUENCIES

- (4) With the frequency set to 144.100, turning the RIT volume fully clockwise and counterclockwise from its center position, confirm that the frequency is varied more than ± 1.5 kHz.

Less than 8.2985MHz \leftrightarrow More than 8.3015MHz

- (5) Frequency adjustment at RIT OFF

With the RIT switch set to OFF and the frequency to 144.100MHz, adjust VR3 in the carrier unit (Fig. 3) for 8.3000MHz.

Check points:

- 1) The frequency should not be varied when the RIT switch is turned to ON and OFF.
- 2) The frequency should be varied every 4 positions of the rotary switch.

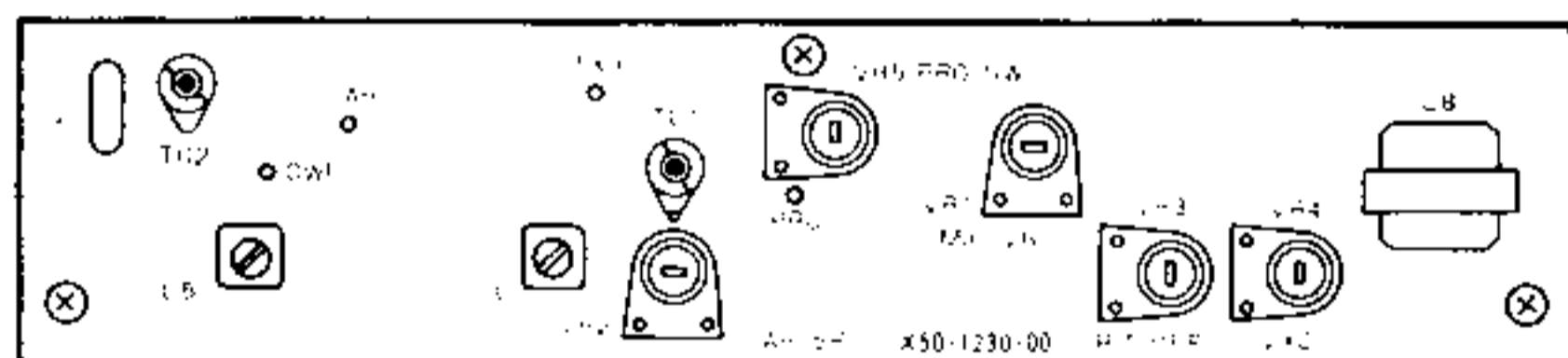

FIG. 3 CARRIER UNIT

2. 41MHz Oscillation Adjustment

A. Setting positions of knobs on panel

- (1) Receiving
- (2) RIT volume: Center
- (3) VXO volume: Center

B. Adjustment

- (1) Set the VFO-SYNTHESIZER selector switch to SYNTHESIZER position. Set the channel indicator to "00" and the BAND switch to "144.1".
- (2) Connect the frequency counter to the TP terminal on the synthesizer unit (see Fig. 2 and Fig. 4).
- (3) Turn the core of L11 in the synthesizer unit counterclockwise to confirm the starting point of oscillation.

Adjust the core so that the frequency counter counts the frequencies properly in the vicinity of 125.1015MHz.

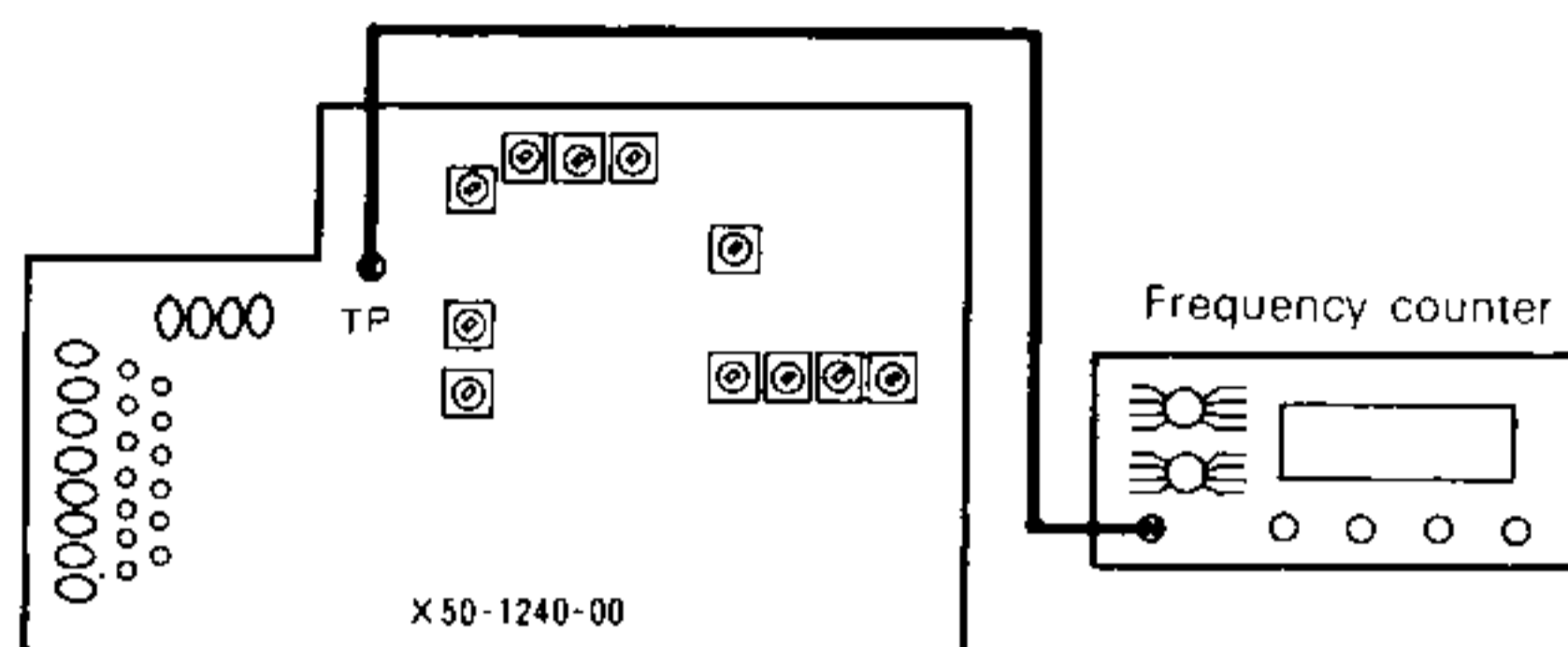

FIG. 4 41MHz OSCILLATION ADJUSTMENT

3. VXO Frequency Adjustment

A. Setting positions of knobs on panel

- (1) Receiving
- (2) VXO volume: Center

B. Adjustment

- (1) Connect the frequency counter to the TP terminal on the synthesizer unit (see Fig. 2 and Fig. 4).
- (2) Set the VFO-SYNTHESIZER selector switch to SYNTHESIZER position and the channel indicator to "00".
- (3) Adjust L1 ~ L4 so that the frequency counter indicates as shown in Table 2.

Channel Indicator	Frequency for Adjustment	Adjusting Coil
00	125.1015MHz	L1
05	125.1065MHz	L2
10	125.1115MHz	L3
15	125.1165MHz	L4

TABLE 2 VXO FREQUENCY ADJUSTING POINTS

NOTE: If the cores of L1 ~ L4 are too much out of the center position during adjustment, set them to the center position and then adjust the frequency using L11 (readjustment should be made from 41MHz Oscillation Adjustment under the item 2).

- (4) VXO operation check
With the channel indicator set back to "00", turning the VXO volume fully clockwise and counterclockwise from its center position, confirm that the frequency is varied more than ± 2.5 kHz. Less than 125.0990 MHz \leftrightarrow More than 125.1040 MHz.
- (5) Set the VFO-SYNTHESIZER selector switch on the rear of the case to "VFO" with the channel indicator remaining in "00". Adjust VR4 on the carrier unit (Fig. 3) for 125.1015MHz.

ADJUSTMENTS

Check Points:

- 1) The frequency should be varied every 4 positions of the rotary switch.
- 2) The adjusting frequency should be within $\pm 300\text{Hz}$.

4. Carrier Oscillation Frequency Adjustment

A. Setting positions of knobs on panel

Any position

B. Adjustment

- (1) Connect RF VTVM to CAR terminal on the carrier unit (see Fig. 3 and Fig. 5).

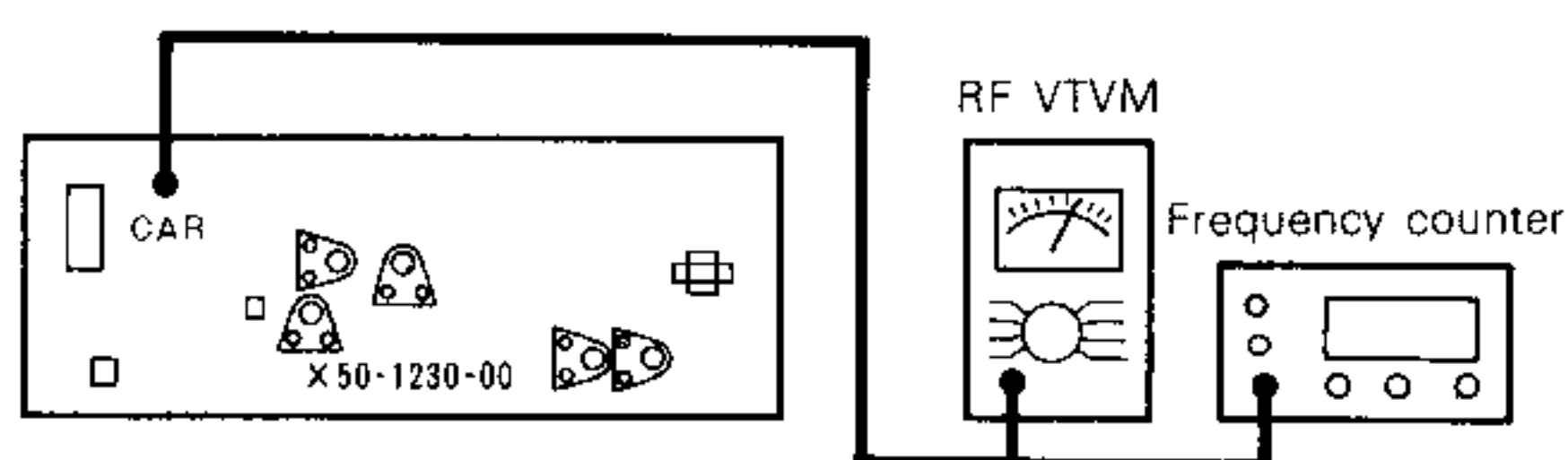

FIG. 5 CARRIER OSCILLATION ADJUSTMENT

- (2) Adjust L5 for maximum reading on RF VTVM.
- (3) Adjustment of SSB carrier oscillation frequency: Remove RF VTVM and connect the frequency counter to CAR terminal on the carrier unit (Fig. 5). Adjust TC2 for 10.6985MHz.
- (4) Adjustment of CW carrier oscillation frequency: Under the transmit mode, set CW/SSB switch to "CW" (press down) and adjust VR3 on the synthesizer unit (Fig. 2) for 10.6992MHz.

5. HET Adjustment (Important)

A. Setting positions of knobs on panel

CW/SSB switch: SSB (OFF) position
BAND switch: 144.2MHz position
Channel indicator: "95"
VFO-SYNTHESIZER selector switch (on the rear of case):
SYNTHESIZER position

B. Adjustment

- (1) Insert the adjusting crystal (8.900MHz) into the crystal socket on the synthesizer unit (Fig. 6).

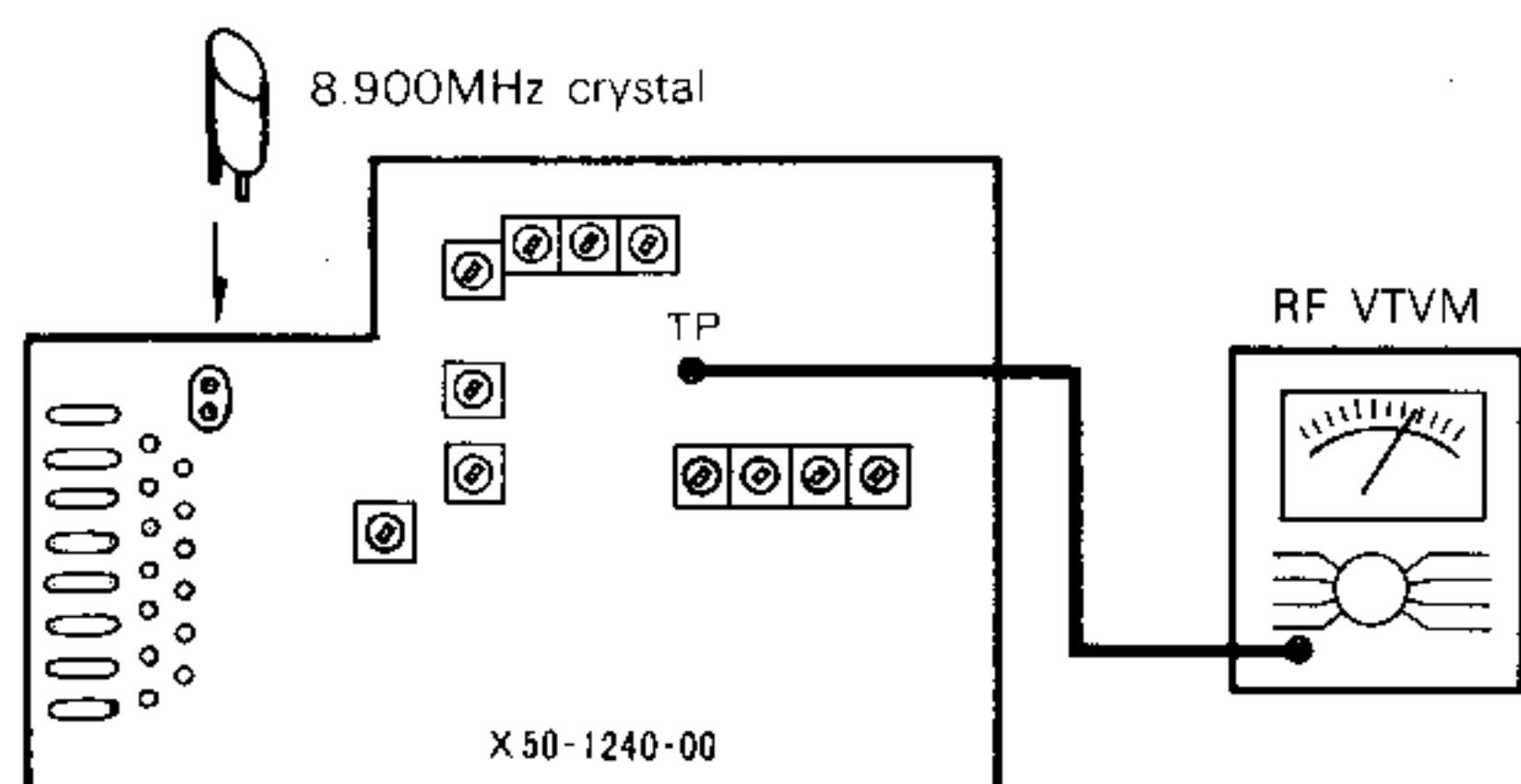
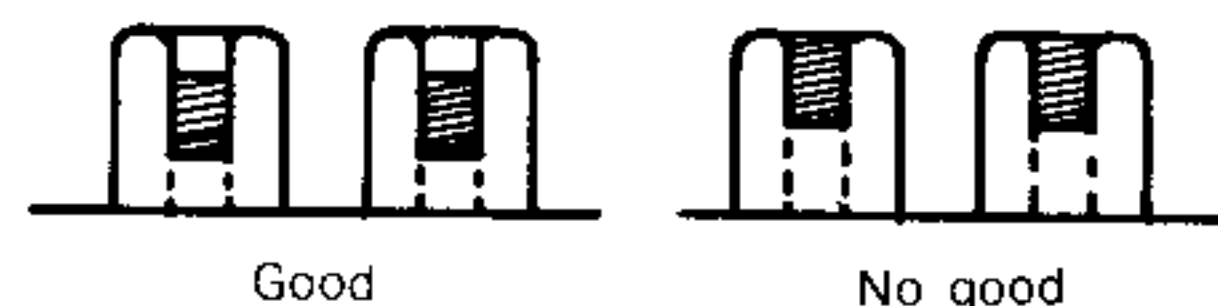

FIG. 6 HET ADJUSTMENT

- (2) Connect RF VTVM (1V range) to the TP terminal (Fig. 6).
- (3) Under the transmit mode, obtain a maximum reading on RF VTVM by adjusting L12 → L13 → L15 → L16 → L17 → L18 → L19 (f: 144.295MHz). This adjustment should be made several times.

NOTE: L12 and L13 should be tuned at the inner position as shown in the illustration below.



- (4) Set the channel indicator from "95" (144.295MHz) to "A" (144.70MHz) and adjust L14 for maximum reading on RF VTVM.
- (5) With the channel indicator set back to "95", obtain a maximum reading on RF VTVM by adjusting L12, L13, L15, L16, L17, L18 and L19 (RF VTVM may indicate a variation of 0.4 ~ 0.8V rms).

6. Adjustments of 10.7MHz and 144MHz

A. Setting positions of knobs on panel

CW/SSB switch: CW(ON) position
Frequency: 144.295MHz
VFO-SYNTHESIZER selector switch (on rear of case):
SYNTHESIZER position
Others: Any position

B. Adjustment

- (1) Remove the press-fitted lead from the OUT terminal on the synthesizer unit.
- (2) Connect RF VTVM to the TP terminal on the synthesizer unit (Fig. 7).
- (3) Set into transmitting
- (4) Obtain a maximum reading on RF VTVM by adjusting L3 on the carrier unit (Fig. 3) and L22 and L23 on the synthesizer unit (Fig. 2). The reading should be about 0.25V rms at 0.3V range.
- (5) Next, connect RF VTVM (3V range) to the OUT terminal (Fig. 7) on the synthesizer unit and then set TC16 to 1/2 in capacitance.
- (6) Obtain a maximum reading on RF VTVM by adjusting L24, L25, L26 and L27. Also adjust TC14 and TC15 for maximum reading.

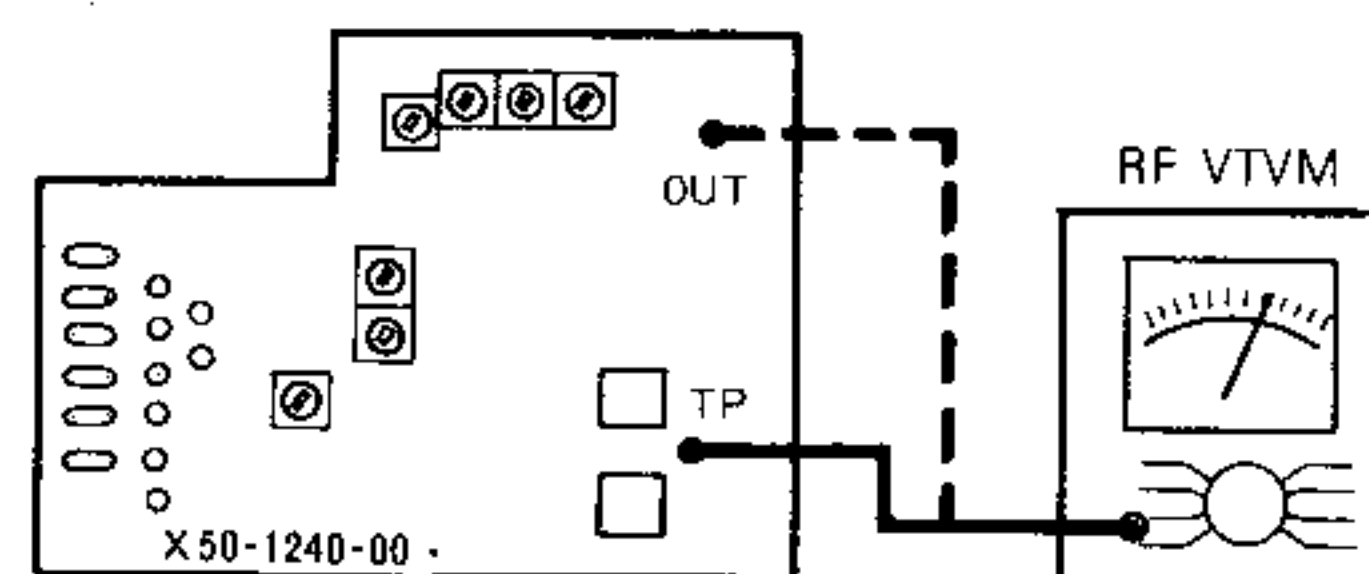

FIG. 7 ADJUSTMENT OF HF AMPLIFIER

ADJUSTMENTS

7. Power Adjustment

A. Setting positions of knobs on panel

Same as the item 6 above.

B. Adjustment

- (1) Connect the power meter to the ANT terminal and the press-fitted lead (removed under the item 6) to the OUT terminal. Set VR3 on the filter unit (Fig. 8) and VR5 on the carrier unit (Fig. 3) to minimum and then connect the ampere meter (DC 0 ~ 4A) to the power supply (Fig. 9).

NOTE: The ampere meter equipped with the DC power supply may be used.

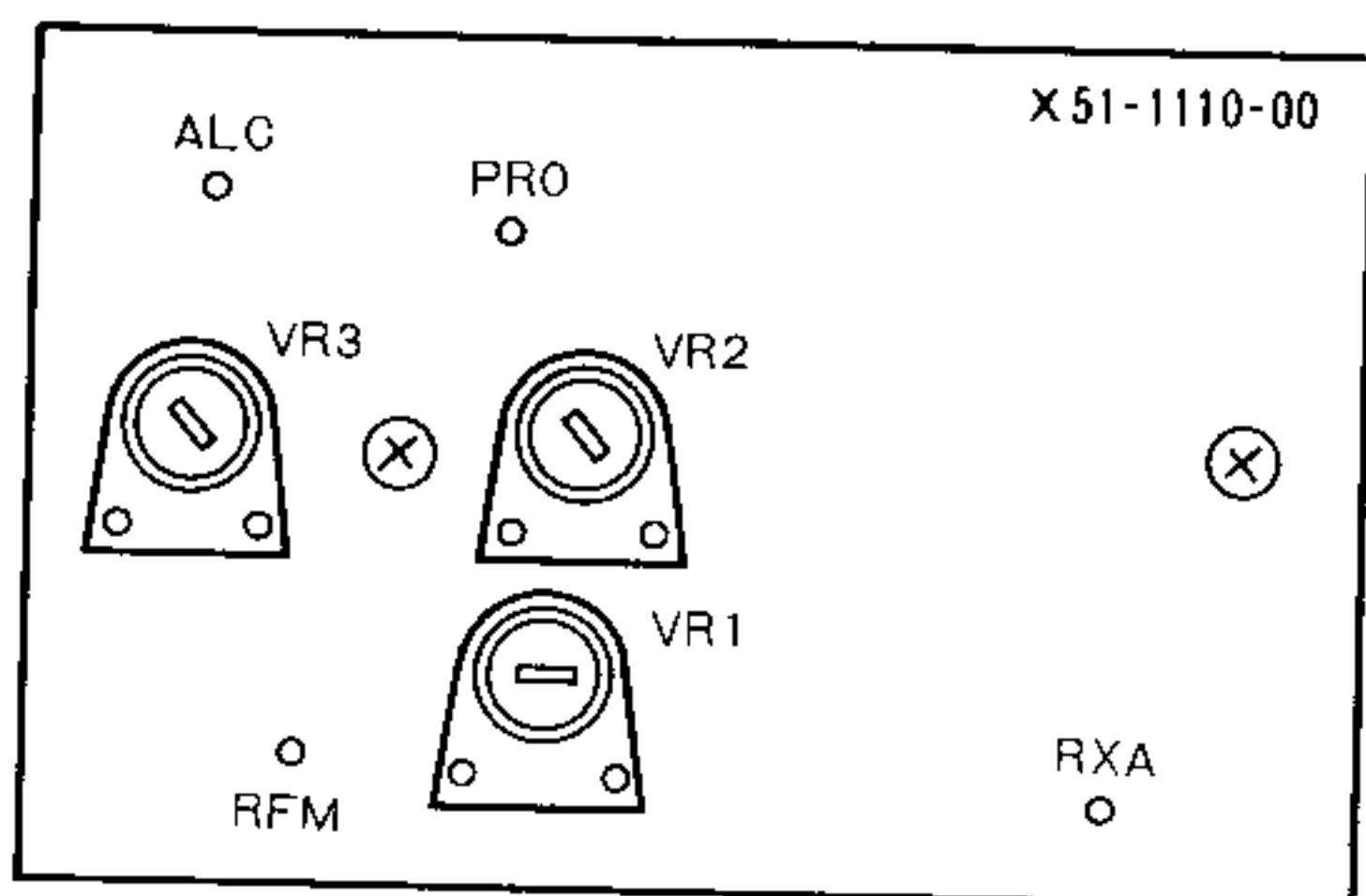

FIG. 8 FILTER UNIT

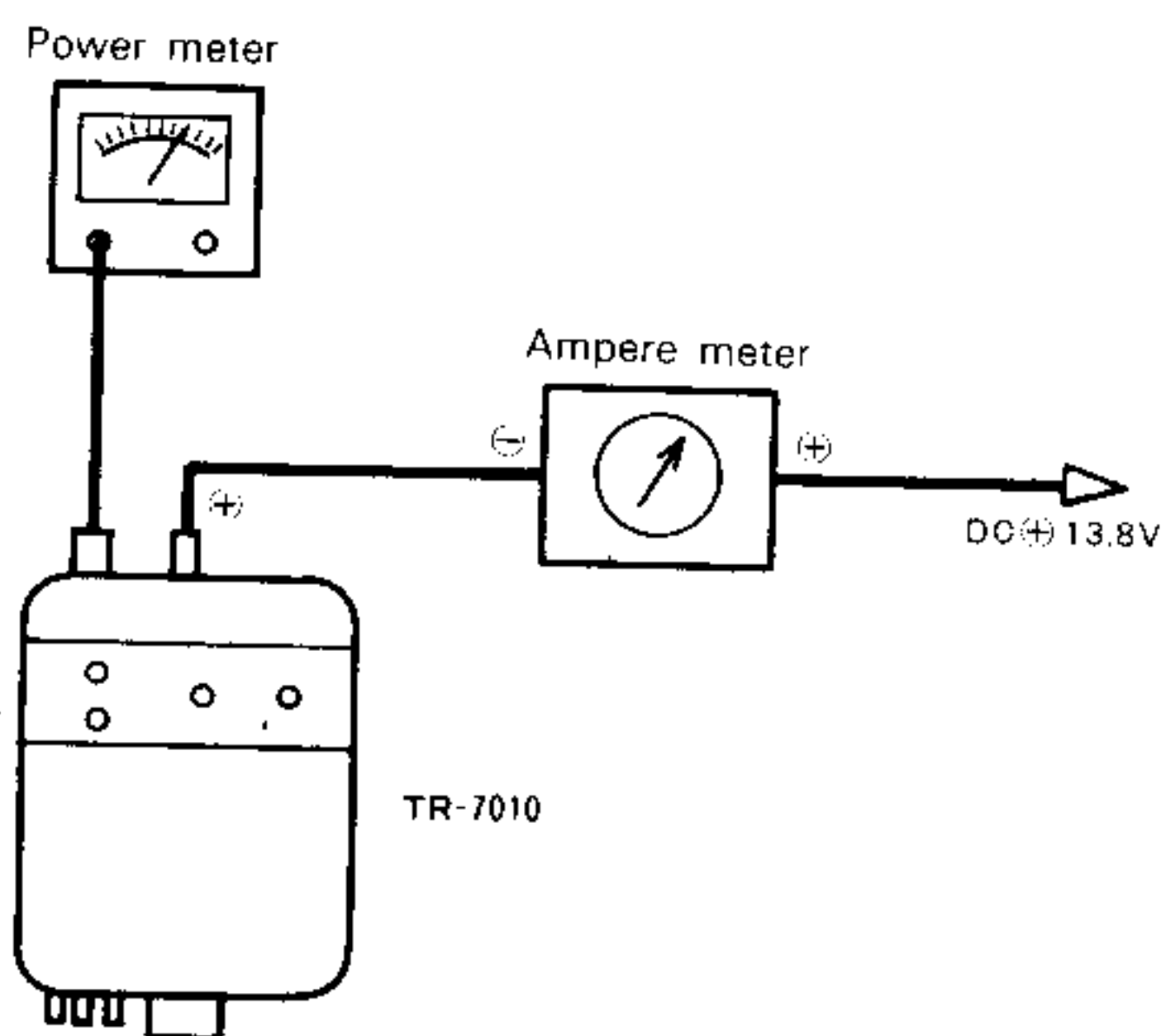

FIG. 9 CONNECTION OF AMPERE METER

- (2) Adjust TC1 on the final unit (Fig. 10) for maximum current. Then, adjust TC16 on the synthesizer unit (Fig. 2) for maximum output.

NOTE: Adjustments should be made in the above mentioned order.

- (3) Obtain a maximum output by adjusting TC2, TC3 and TC4 on the final unit (Fig. 10). Be sure that TC4 is turned in the direction where the current is decreased while the output remains unchanged.

This adjustment should be made carefully because it largely relates to spurious radiation.

NOTE: The power meter may indicate a variation of $12W \pm 1W$.

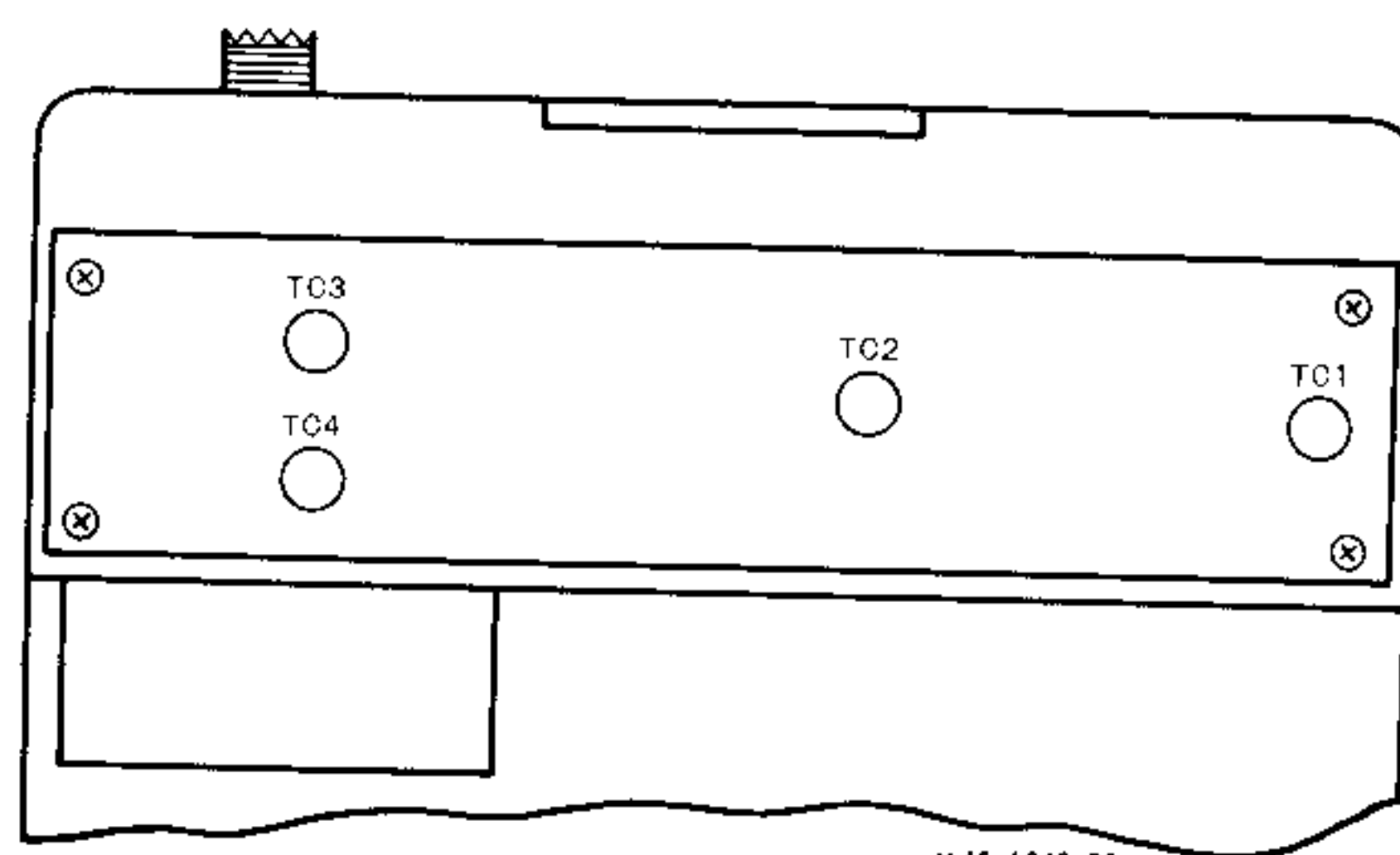

FIG. 10 PA UNIT

8. ALC Adjustment

Remaining the condition of item 7, proceed as follows:

- (4) Adjust VR3 on the filter unit (Fig. 8) until the transmit output reaches 10W.

9. Adjustment of RF Meter Indication

Remaining the condition of the item 8, proceed as follows:

- (5) Adjust VR1 on the filter unit so that the S meter indicates the "9" position on the scale ("8" position on RF scale).

10. Protection Adjustment

Remaining the condition of the item 9, proceed as follows:

- (6) Connect the voltmeter (DC 3V range) to the PRO terminal on the filter unit (Fig. 8).
- (7) Precisely adjust VR2 on the filter unit for minimum reading on the voltmeter.
- (8) Remove the power meter from the ANT terminal and adjust VR5 on the carrier unit (Fig. 3) so that the meter indicates the RF "5" (upper section of the figure "5").

11. Adjustment of Carrier Suppression

A. Setting positions of knobs on panel

CW/SSB switch: SSB position (OFF condition)

Channel indicator: "95" position

BAND switch: 144.2 position

VFO-SYNTHESIZER selector switch: SYNTHESIZER position

Others: Any position

B. Adjustment

- (1) Connect the power meter to the ANT terminal. Connect RF VTVM (0.3V range) to the ANT terminal of the filter unit (Fig. 11).
- (2) Short the MIC terminals "2" and "4" to set into transmitting.
- (3) Adjust alternately VR2 and TC1 on the carrier unit (Fig. 3) for minimum reading on RF VTVM. This adjustment should be repeated two or three times.

ADJUSTMENTS

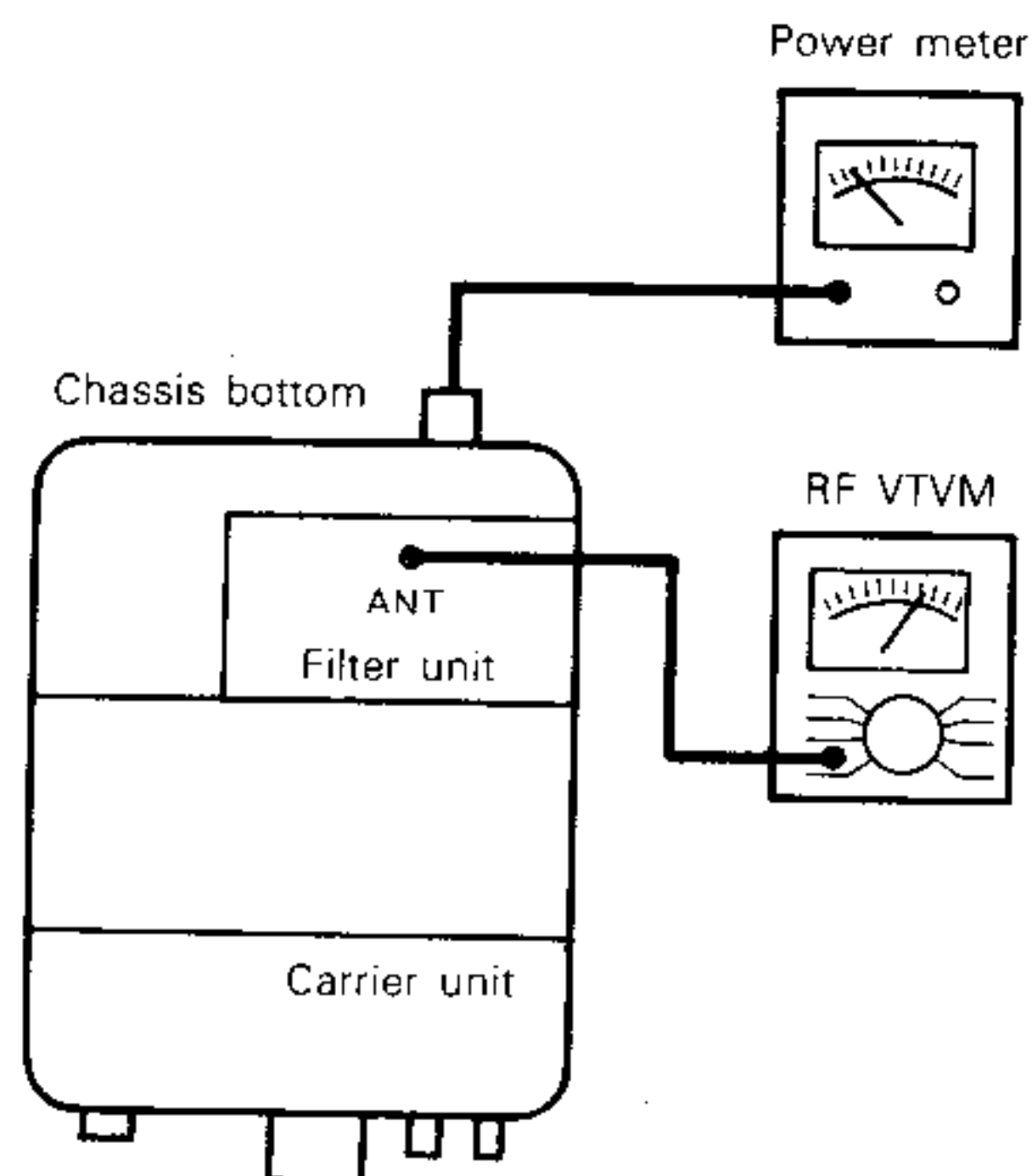

FIG. 11 ADJUSTMENT OF CARRIER SUPPRESSION

12. SSB Power Adjustment

After the adjustment under the item 11 above, proceed as follows:

- (4) Remove RF VTVM and connect the audio generator (AG) to the MIC terminal. Set the generator output to 3mV/600Ω, 1,500Hz.
- (5) Under the transmitting, adjust VR1 on the carrier unit (Fig. 3) until the power meter indicates 9W.

NOTE: Before readjusting the final unit, be sure to set ALC to OFF (turn VR3 on the filter unit fully clockwise).

13. Readjustment of Heterodyne Coil (L14)

- (1) Remove all the measuring instruments, except for the power cord (receiving). Set the channel to "A" and insert the adjusting crystal (8.9MHz for 144.70MHz) into the crystal socket (Fig. 6).
- (2) Connect RF VTVM to the 8MHz TP terminal (Fig. 2) on the synthesizer unit and then adjust L14 for maximum reading on RF VTVM.

14. Helical Adjustment

A. Setting positions of knobs on panel

- Receiving
 Channel indicator: "00"
 BAND switch: 144.2MHz position
 RF GAIN volume: Fully clockwise (MAX)
 VFO-SYNTHESIZER selector switch: SYNTHESIZER position
 Antenna terminal: Unconnected
 NB switch: ON position
 Others: Any position

B. Adjustment

- (1) Adjustment setup is shown in Fig. 12.

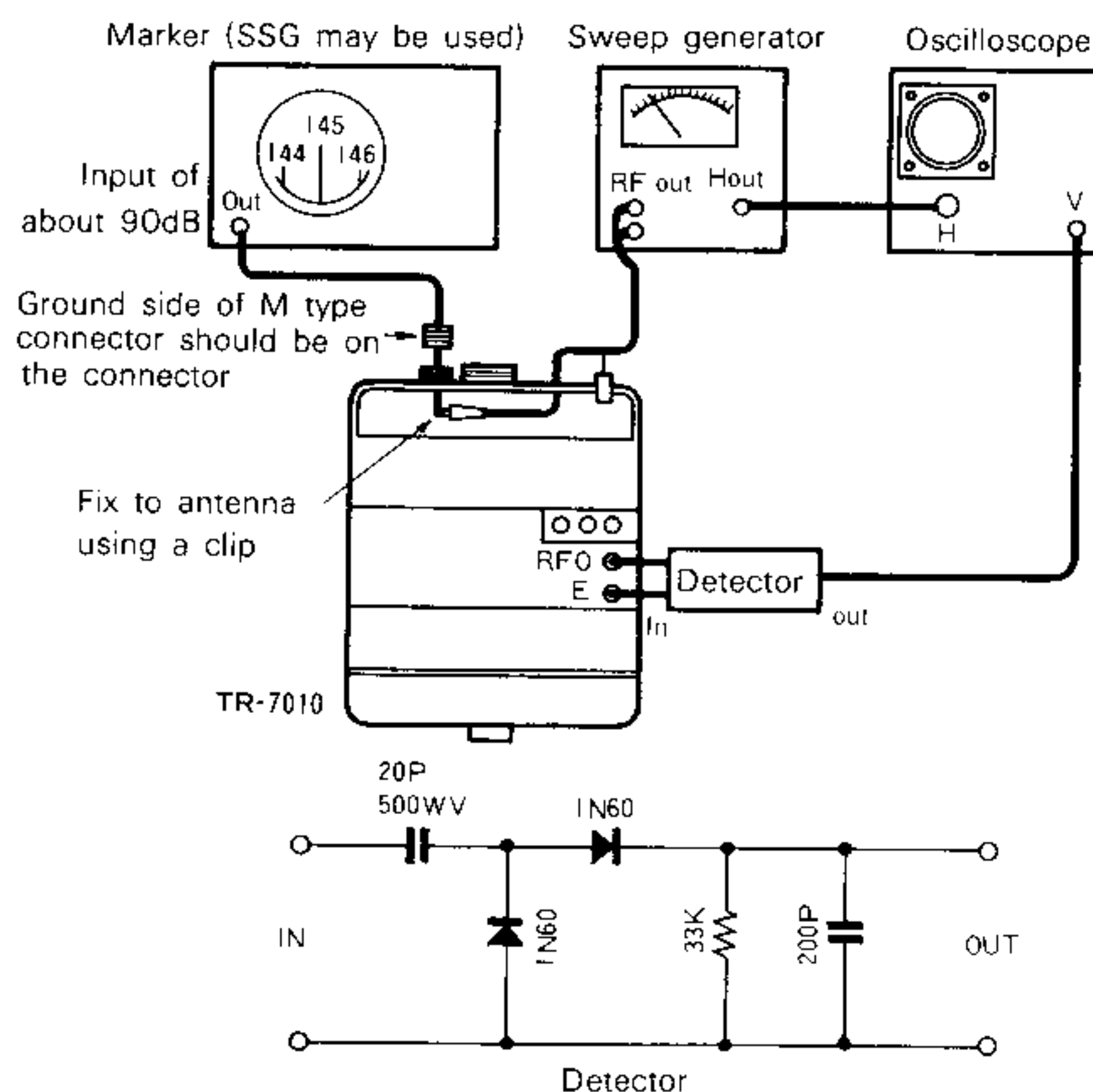

FIG. 12 HELICAL ADJUSTMENT

- (2) Turn the power switch to ON (power voltage: 13.8V).
- (3) Produce 144MHz marker signal (Fig. 13) and adjust TC2 and TC1 for maximum gain.
- (4) After the maximum gain is obtained, turn TC3 just about 1 rotation so that the gain is decreased.

NOTE: Since the frequency band of this unit is 144 ~ 145MHz, only the 144MHz marker signal is enough for the adjustment.

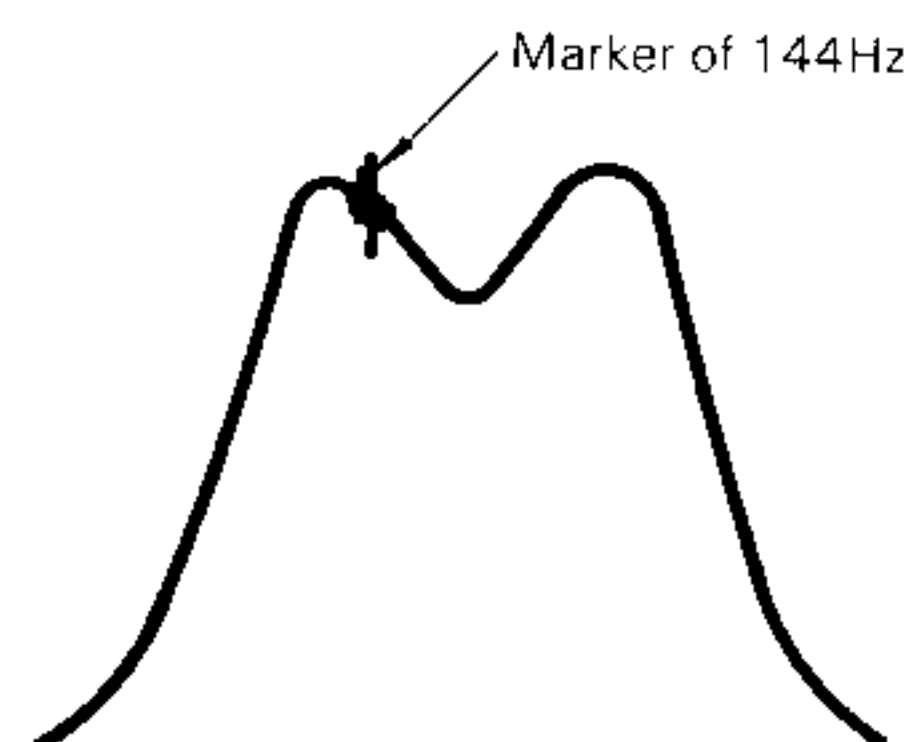

FIG. 13 WAVEFORM AT HELICAL SECTION

15. Voltage Setting of RX, HET

- (1) Disconnect all the measuring instruments. Set the channel indicator to "00" and the BAND switch to 144.2MHz.
- (2) Connect RF VTVM to the TP terminal on the RX unit (see Fig. 14 and Fig. 15).
- (3) Adjust VR4 on the RX unit until the voltage reaches 0.3V.

NOTE: When the voltage does not reach 0.3V with VR4, turn L19 (less than 1/4 turn) on the synthesizer unit (Fig. 2).

ADJUSTMENTS

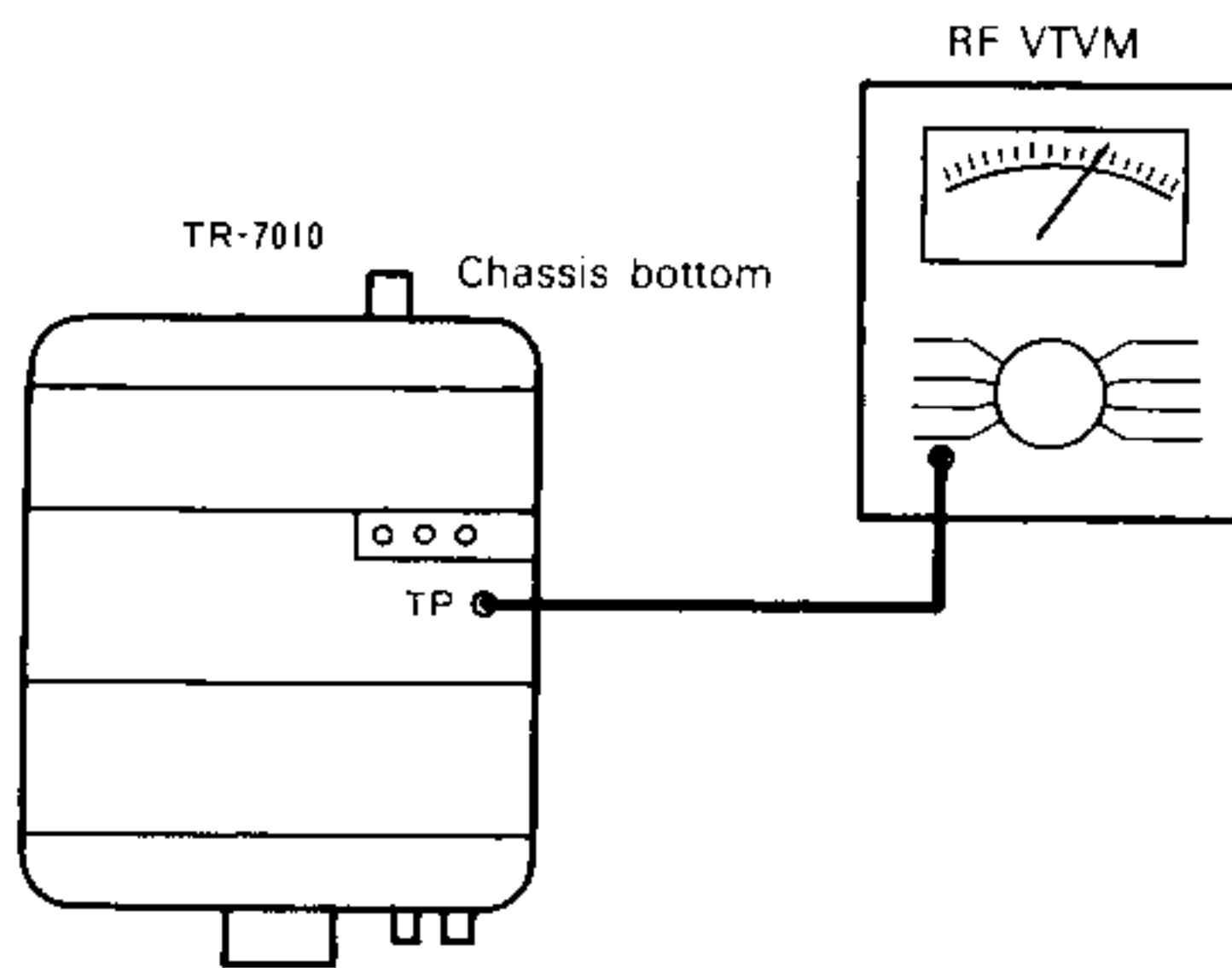

FIG. 14 RX, HET VOLTAGE SETTING

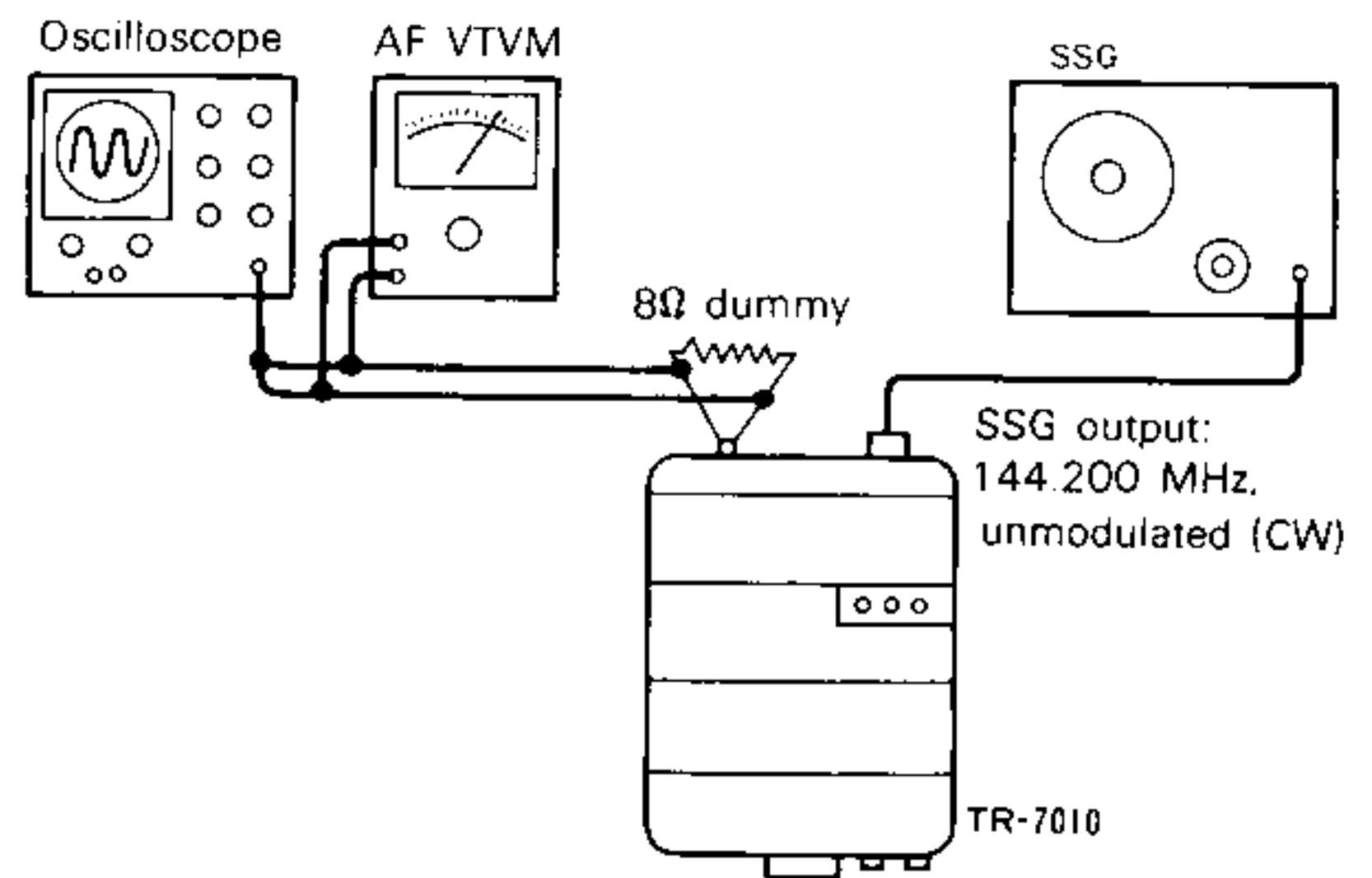

FIG. 16 RECEIVE SENSITIVITY ADJUSTMENT

16. "0" Point Setting of S Meter

A. Setting positions of knobs on panel

Receiving mode.

Channel indicator: "00"

BAND switch: 144.2MHz

RF GAIN volume: Fully clockwise (MAX)

VFO-SYNTHESIZER selector switch: SYNTHESIZER position

Antenna terminal: Unconnected

Others: Any position

B. Adjustment

(1) Adjust VR2 on the RX unit (Fig. 15) until the S meter indicates the exact "0" position.

NOTE: Be sure to set VR2 at the point where the S meter deflects to the "0" position. It should be noted that the meter will not deflect in the "minus" direction even when VR2 is turned further after it has reached the "0" position.

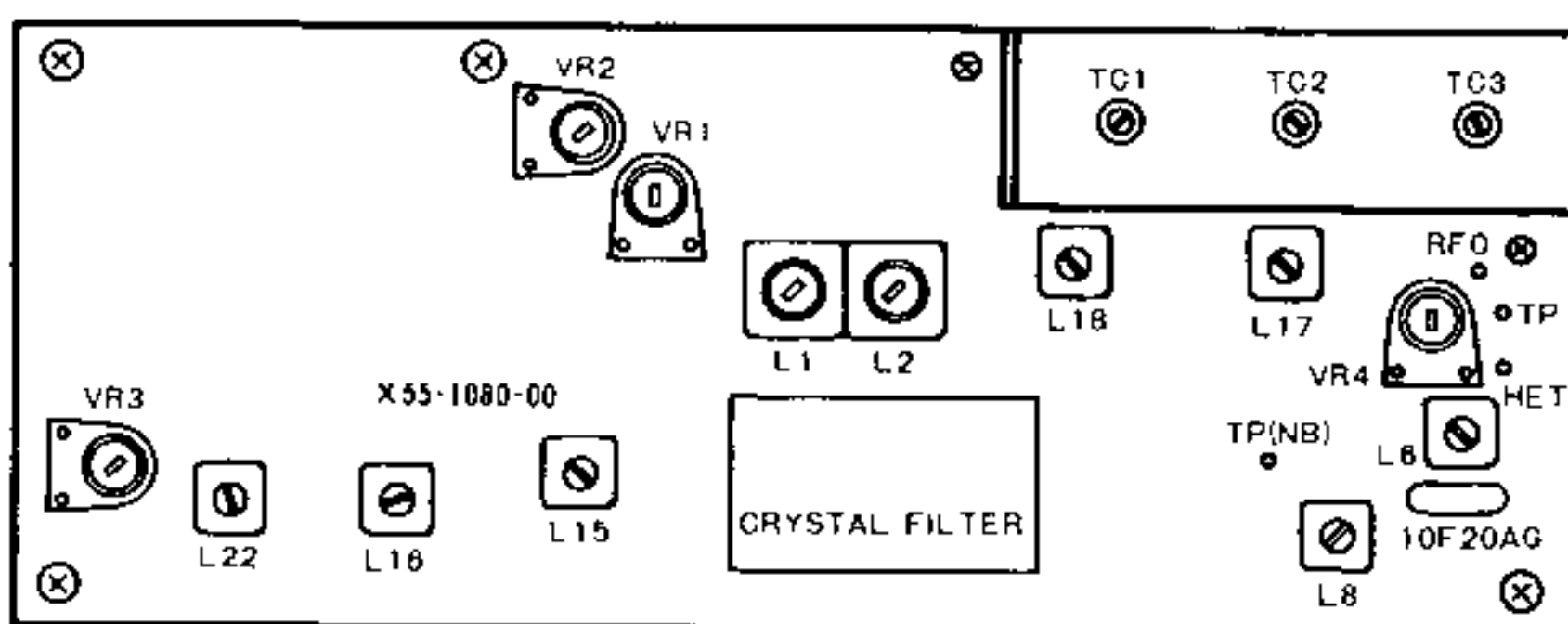

FIG. 15 RX UNIT

17. Adjustment of Receiving Sensitivity

A. Setting positions of knobs on panel

Same as the item 16 above.

B. Adjustment

(1) Connect the measuring instruments as shown in Fig. 16.

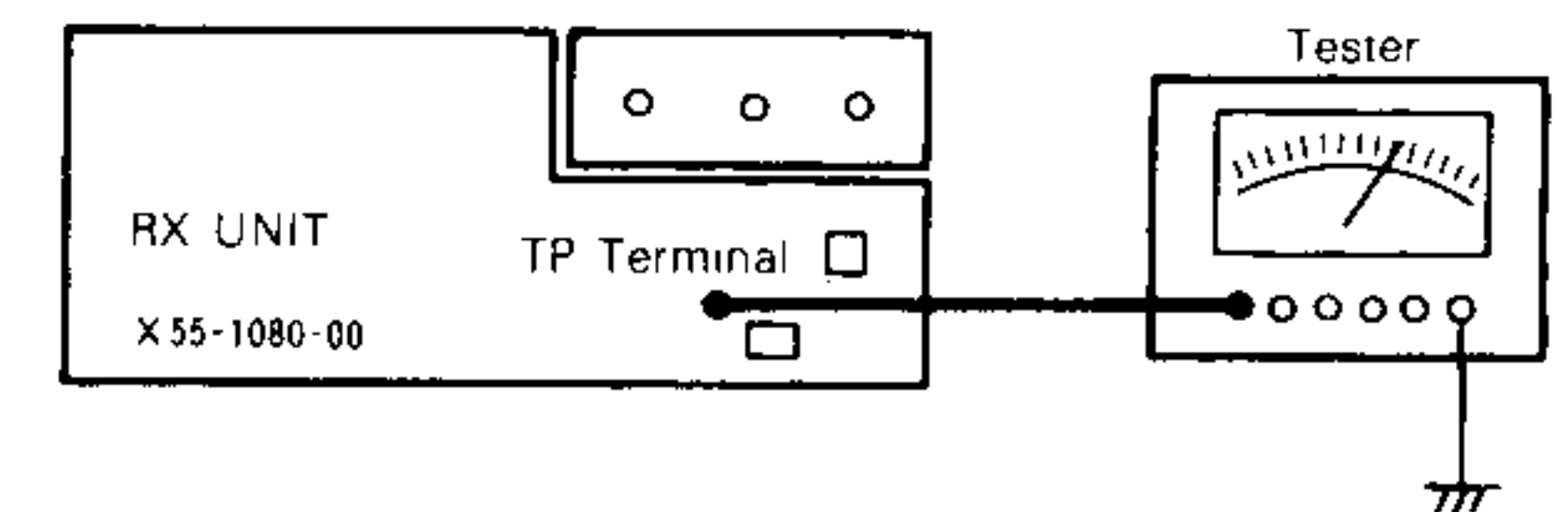

FIG. 17 NB ADJUSTMENT

- (2) Using the input from SSG, tune in to about 144.200MHz and fine adjust VXO volume so that AF signal of about 1,000Hz is obtained on the oscilloscope.
- (3) Slowly decrease the input from SSG and obtain a maximum reading on AF VTVM by adjusting L1 → L2 → TC3 → L6 → L8 → L15 → L16 → L22 on the RX unit (Fig. 15). This adjustment should be repeated several times.
- (4) With the SSG input set to the minimum sensitivity (0dB), precisely adjust TC3 for maximum reading on AF VTVM.

18. NB Adjustment

Remaining the condition of the item 17.

A. Adjustment without synchroscope

- (1) Connect a voltmeter (or tester) to the TP terminal on the RX unit (Fig. 17). Set the SSG input to 20 ~ 30dB and then adjust L17 and L18 for minimum reading on the voltmeter. During the adjustment, the AF waveform should be about 1,000Hz.
- (2) Connect the noise generator to the ANT terminal and fine adjust L17 until the noise waveform on the oscilloscope becomes minimum.

CHANNEL INSTALLATION

INSTALLATION OF OPTIONAL CHANNEL

1. Installation

The unit employs the frequency synthesized system, permitting installations of 8 additional channels; it is provided with 2 crystal sockets for installations so that each crystal covers 4 additional channels.

- * The frequency of any additional channel can be selected in the range of 144.0 ~ 145.0MHz. Use the following equation to obtain a crystal oscillating frequency:

$$Xf = (fd - 135,800.0) \text{ kHz}$$

Where Xf: Crystal oscillating frequency (kHz)
fd: Additional channel wanted frequency (kHz)

Because of the synthesized system, the relation between the indications on the dial and the frequencies are:

Channel Indication	Frequency
A	fd kHz
B	fd + 5kHz
C	fd + 10kHz
D	fd + 15kHz

NOTE: Each crystal operates at the corresponding position of the BAND selector switch. For example, if a crystal is plugged into the "A" socket, it operates only at the "144.1MHz" position of the switch and does not operate at "144.2MHz" position.

Example: For installation of 144.050MHz channel

Use 8.250MHz crystal (for TR-7010) because the crystal oscillating frequency is $144.050 - 135.8 = 8.250\text{MHz}$.

Practically, the following channels can be additionally installed:

- | | |
|---------------|---|
| A: 144.050MHz | } Frequency related to wanted frequency |
| B: 144.055MHz | |
| C: 144.060MHz | |
| D: 144.065MHz | |

2. Installing the Crystal

Remove the upper lid of the case fixed with 2 screws. Then, insert the crystal of desired channel into the crystal socket on the printed circuit board (Fig. 18).

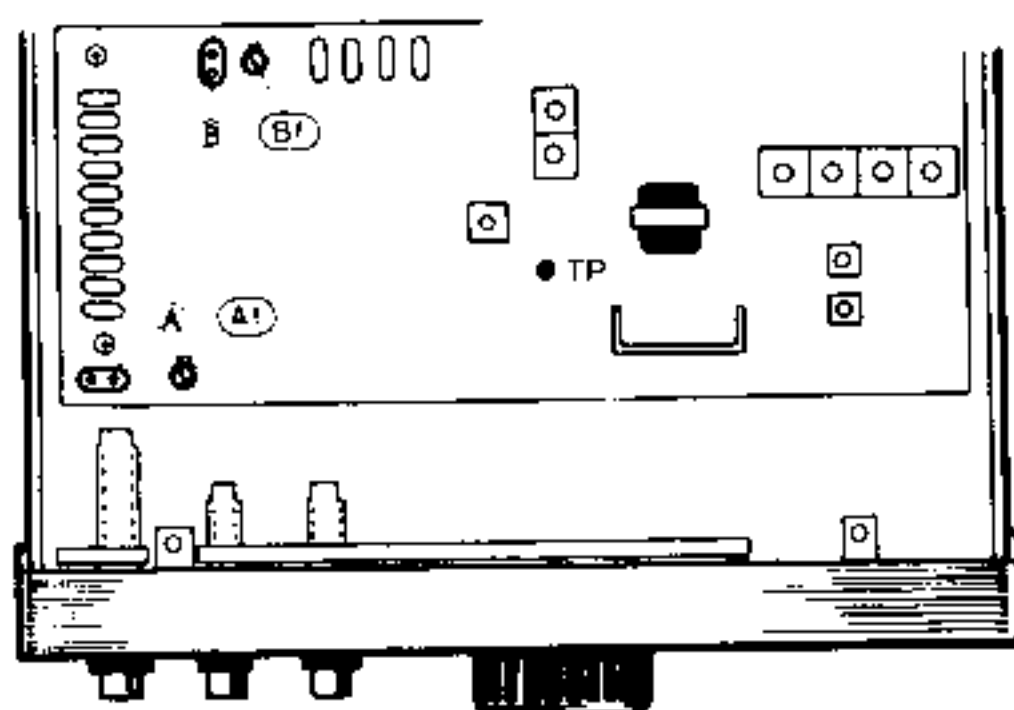

FIG. 18 INSTALLATION OF OPTIONAL CRYSTALS

- (A): Crystal socket for "144.1MHz" position of BAND switch.
 - (A1): Trimmer to adjust oscillation frequency of crystal in "(A)" socket.
 - B: Crystal socket for "144.2MHz" position of BAND switch.
 - (B1): Trimmer to adjust oscillation frequency of crystal in "(B)" socket.
- Note: The trimmers other than "(A1)" and "(B1)" are factory adjusted and require no further attention.

3. Frequency Adjustment

A. Setting positions of knobs on panel

- Receiving
- RIT volume: 12 hour (center) position
- RIT switch: ON
- VFO-SYNTHESIZER selector switch on the rear side: SYNTHESIZER position
- Channel indicator: "A"
- BAND switch: Set to the position corresponding to the additional channel crystal.

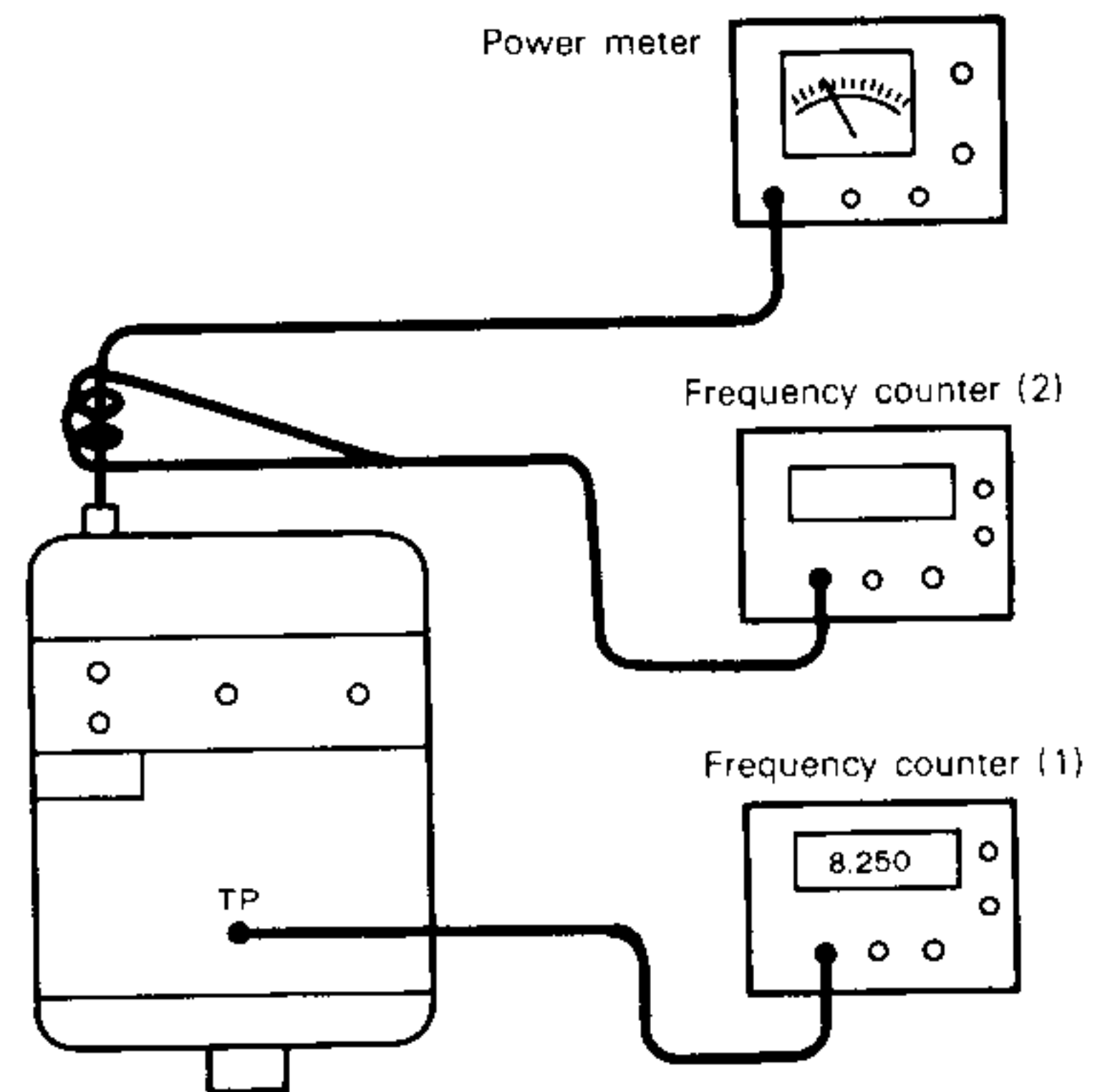

FIG. 19 FREQUENCY ADJUSTMENT

B. Adjustment

- (1) Connect the frequency counter (1) to the TP terminal and the power meter to the ANT terminal (see Fig. 18 and Fig. 19).
- (2) Perform adjustment on the bands of additional channels by referring to Table 3 below.
- (3) Connect the frequency counter to the point (2) and set the unit in CW transmit mode. Change the position of the channel indicator from A to B, C and D to check that the frequency increases by 5kHz at each position.

Band	Channel Indicator	Adjusting Frequency	Adjusting Trimmer (Fig. 18)
144.1	A	Frequency (Xf) of additional channel crystal	A1
144.2	A	Same as above	B1

TABLE 3

REFERENCE

REFERENCE

1. Dial Indication and Reading

The figure shown on the dial represents the last 2 numbers of the operating frequency. By using the BAND selector switch, the frequency band can be changed quickly to 144.1MHz or 144.2MHz (quick QSY).

The frequency reading is illustrated in Fig. 20.

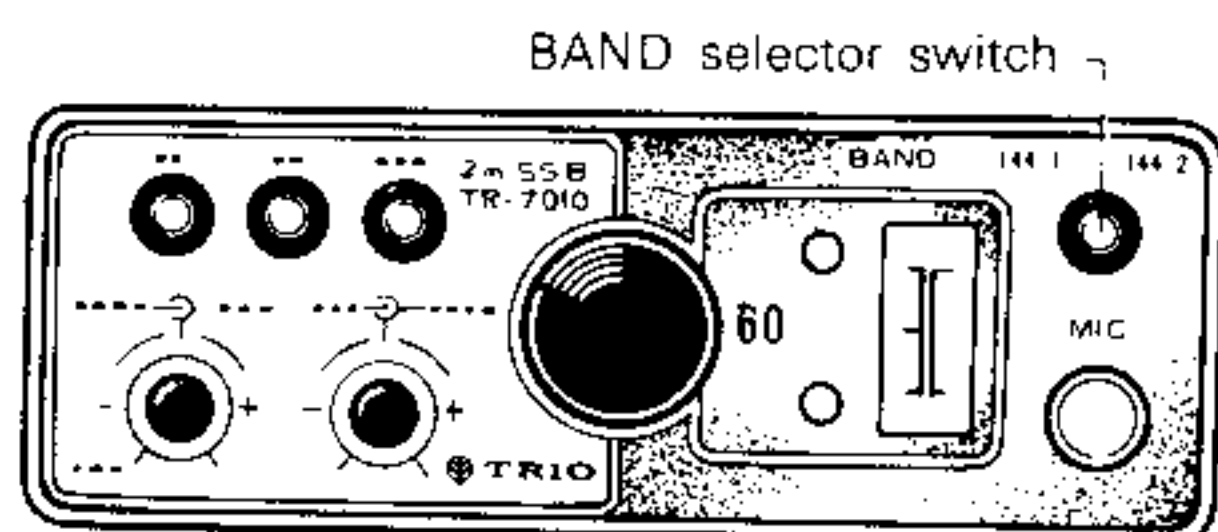

Frequency indicated is:

- ① Setting of BAND switch → 144.160MHz
- ② Setting of BAND switch → 144.260MHz

NOTE: The frequency differs from 144.60MHz of FM unit.

FIG. 20 FREQUENCY READING

2. Power Cord Connection

When connecting the power cord, be sure that the polarity of the cord and plug is correct (Fig. 21).

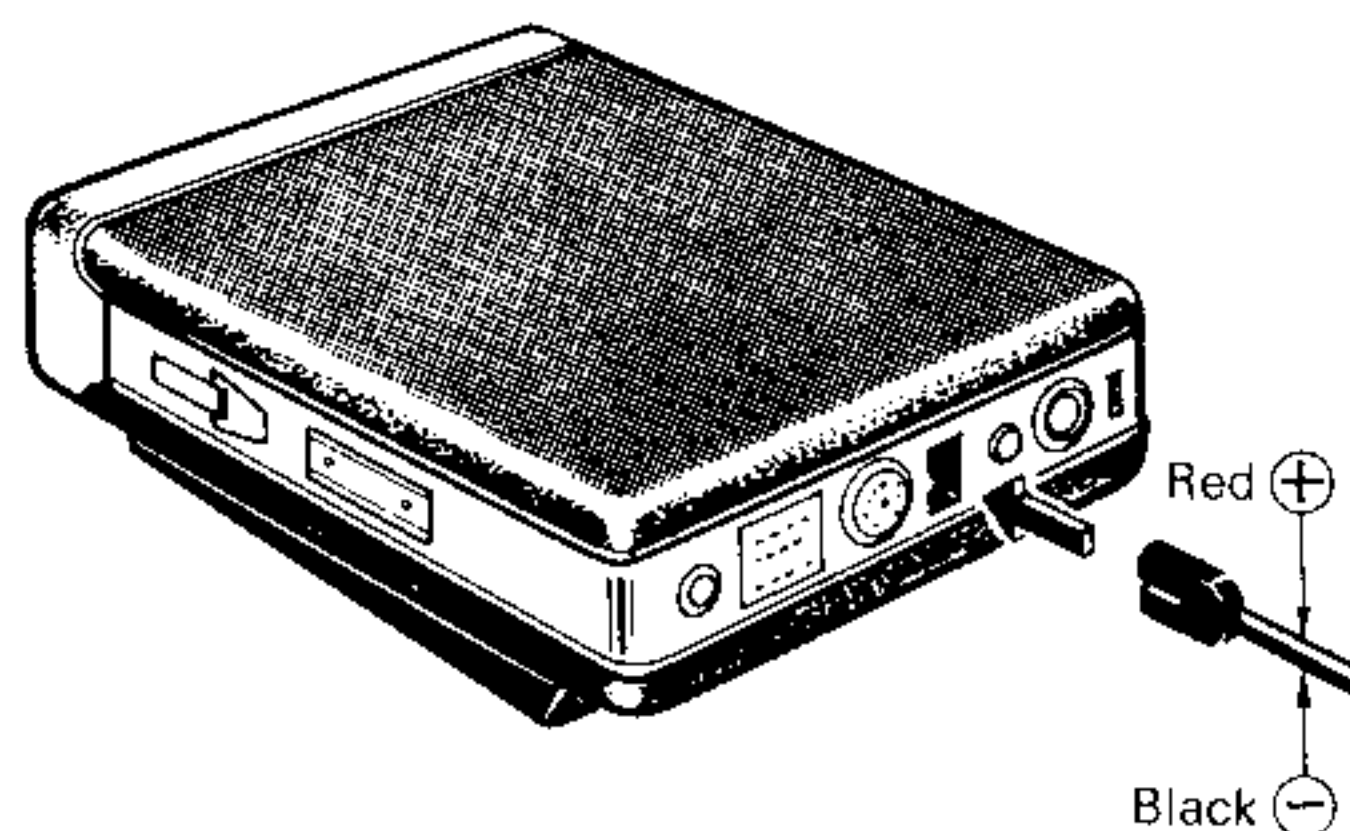

FIG. 21 POWER CORD CONNECTION

3. Key Connection

A miniature single-pin plug is supplied with the unit. Connect the plug to the key as shown in Fig. 22.

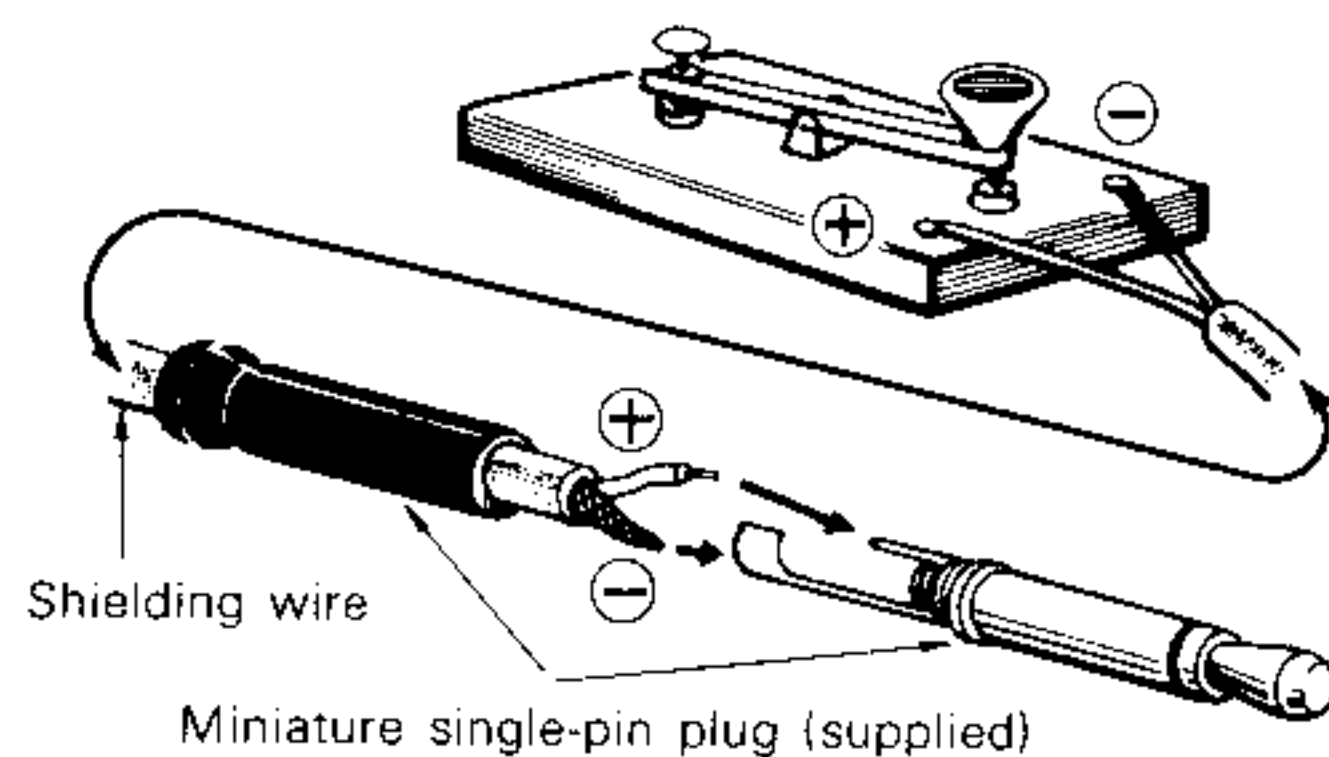

FIG. 22 KEY CONNECTION

4. AUX Terminal

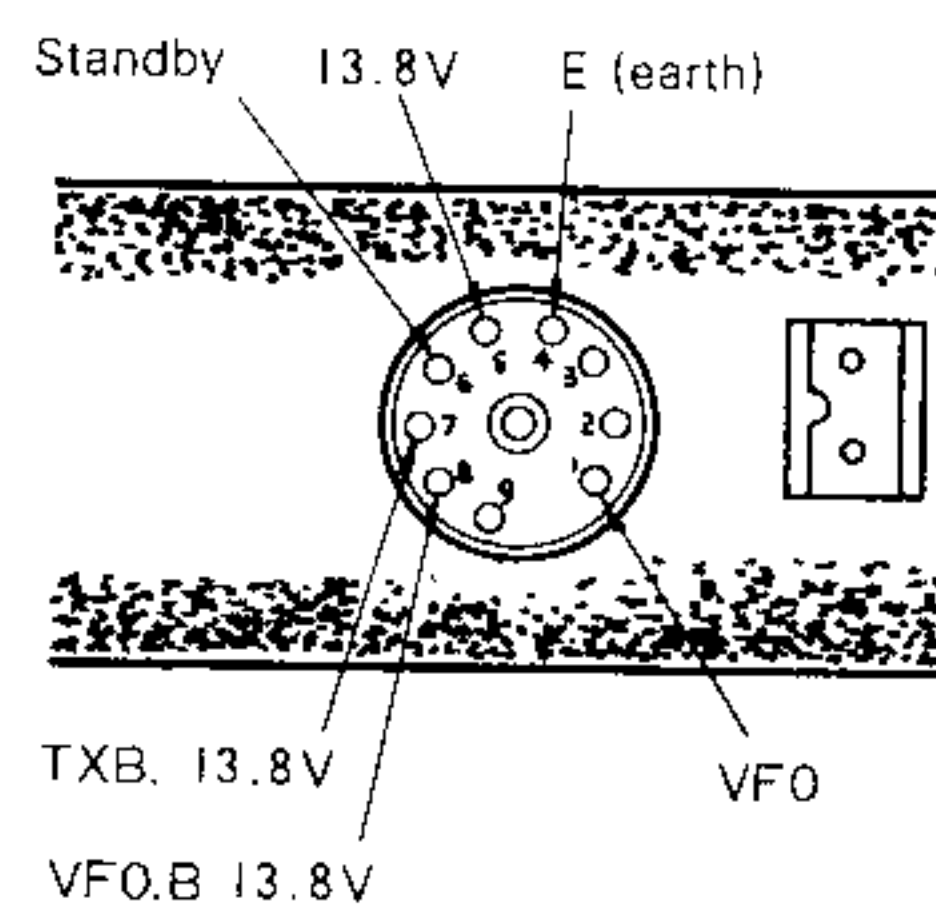

FIG. 23 AUX TERMINAL (VIEWED FROM THE REAR OF SET)

5. Connection of Microphone Connector

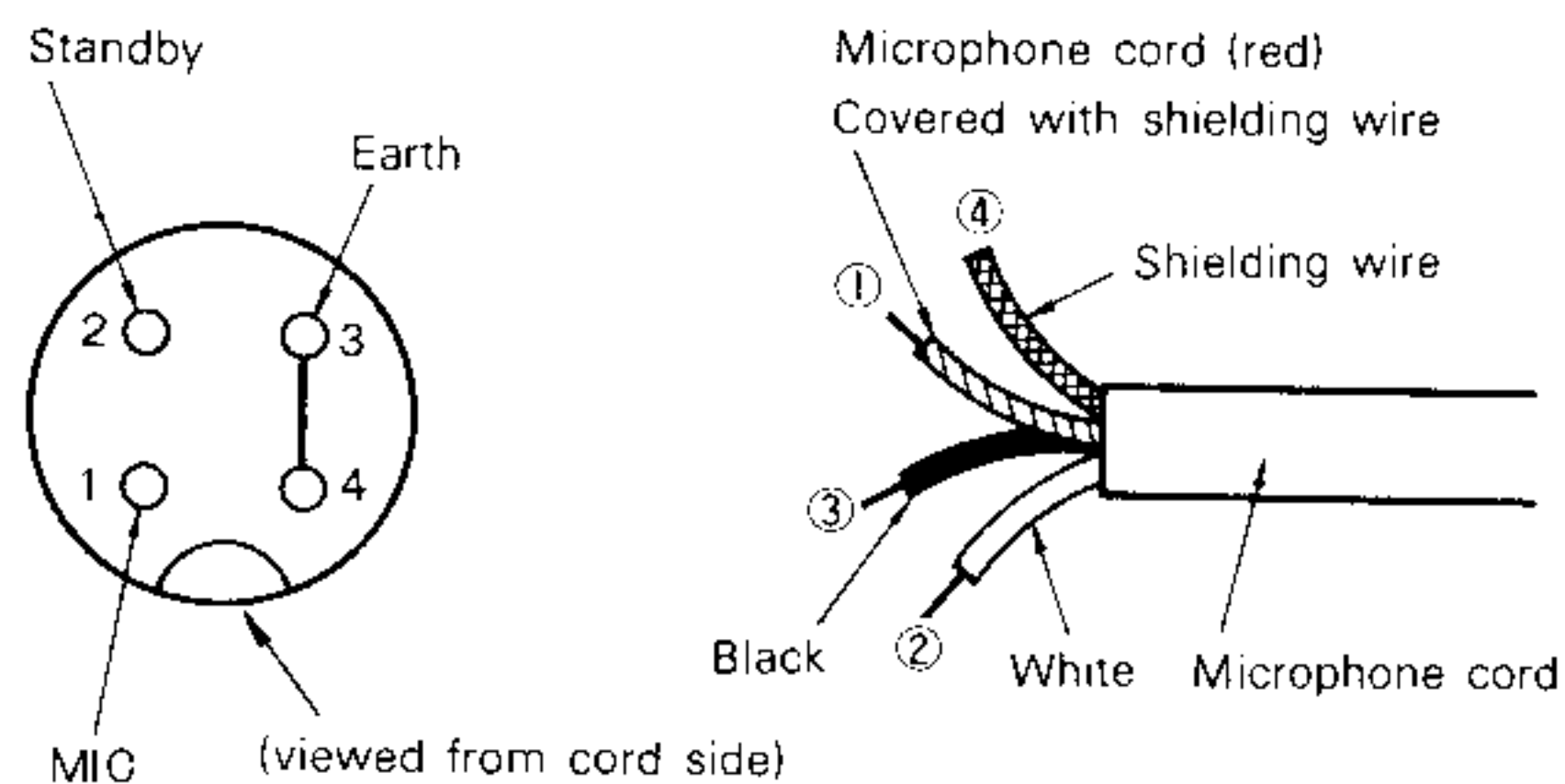
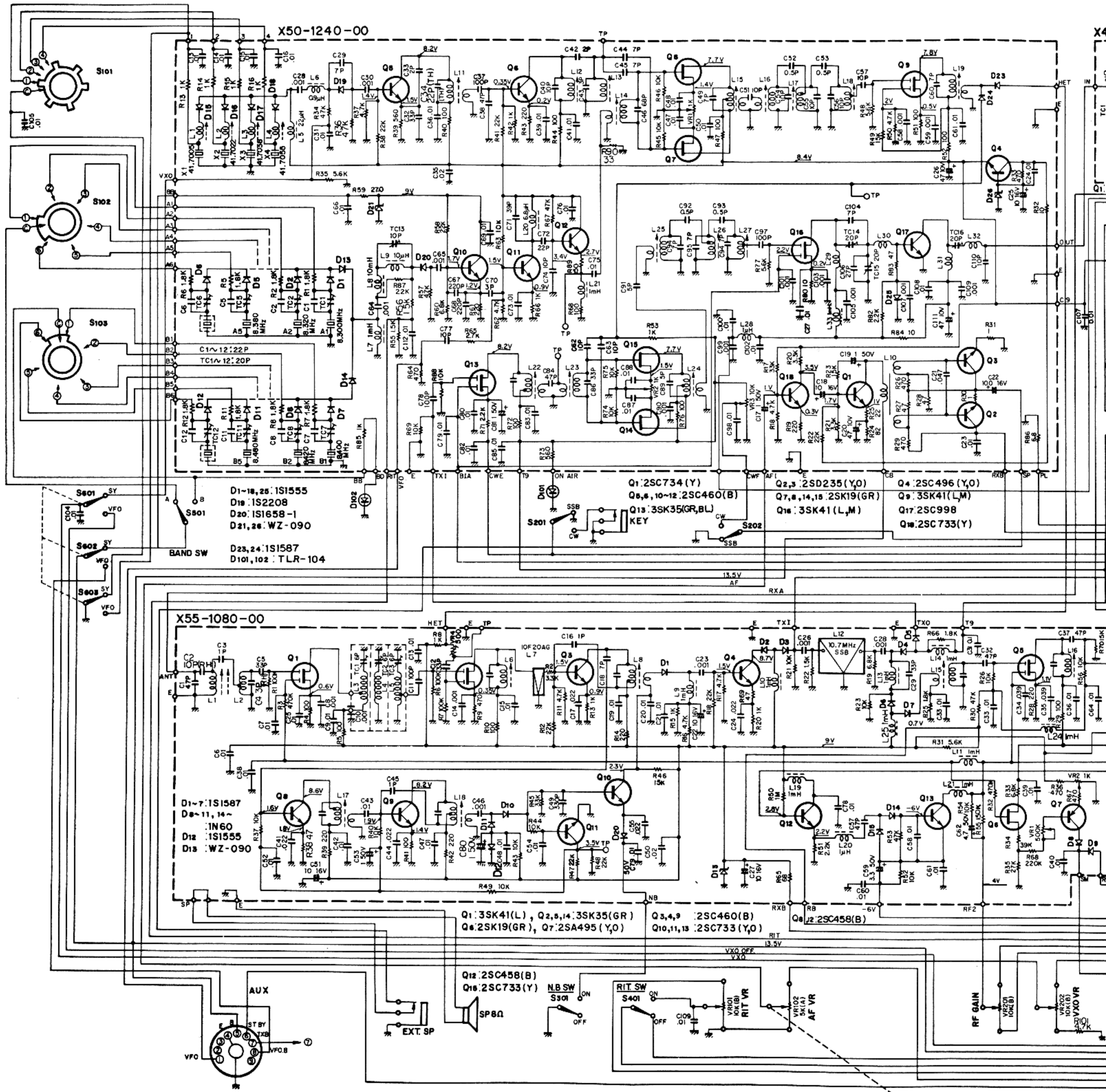
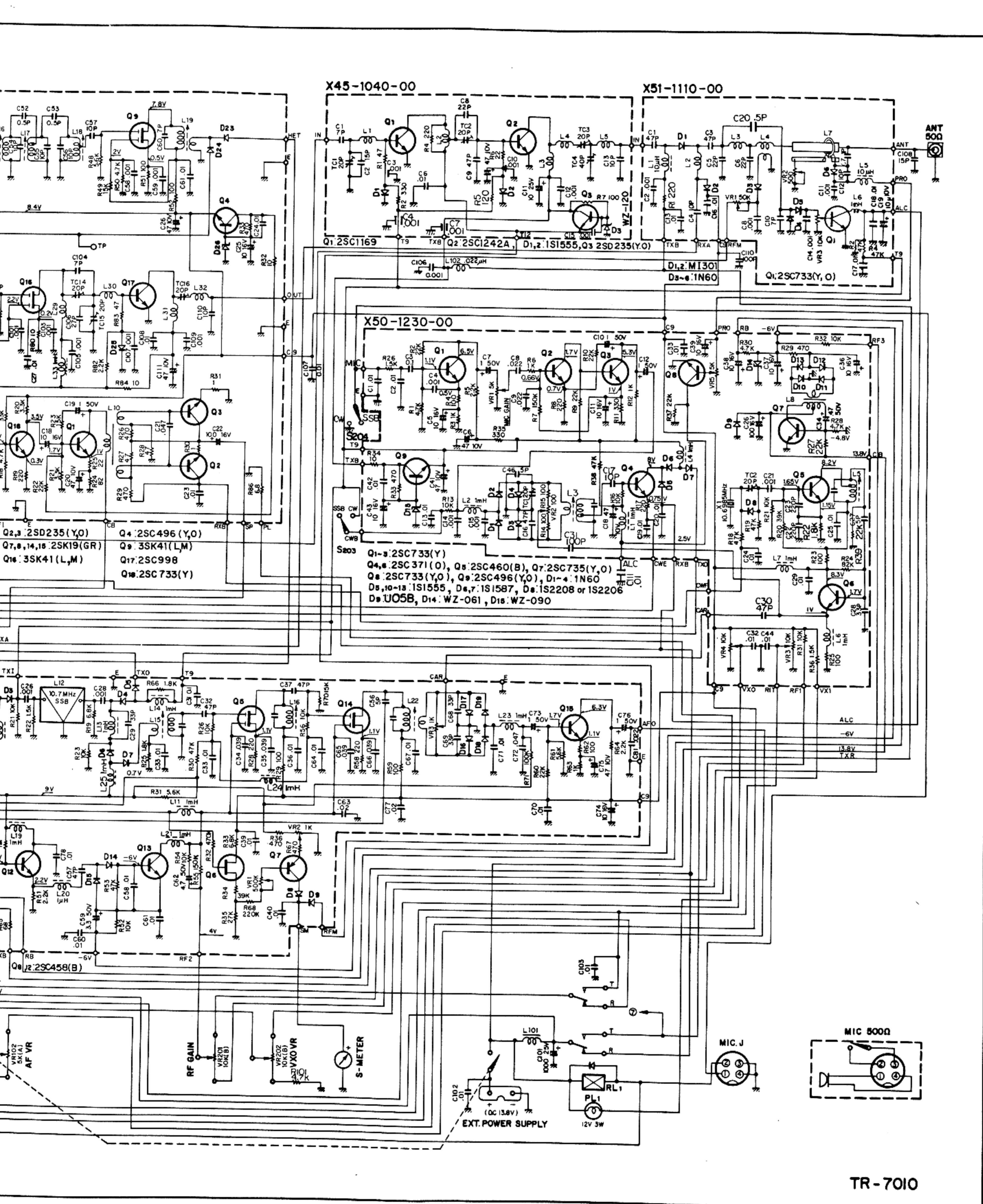

FIG. 24 CONNECTION OF MICROPHONE CONNECTOR



SCHEMATIC DIAGRAM



- 2SC460B
- 2SC458
- 2SC371
- 2SC373
- 2SC388A
- 2SC733
- 2SC734
- 2SC735
- 2SA495
- 2SC998
- 2SA671
- 2SC1061
- 2SD235
- 2SK19
- 2SK30
- 3SK22
- 3SK35
- TA-7045
- MFC4060A
- TA7061AP
- 2N5641
- 2N5642